

ELECTRONIC POWER TRANSFER SWITCH

EPTS SERIES

EPTS MODULE

Key features:

- Supports AC Voltage Dips & Interruptions IEC61000-4-11 and IEC61000-4-34 and Test Standards
- Equivalent Korean KC Dips & Interruption standards
- Supports Three Phase AC Voltage Unbalance IEC61000-4-27 Test Standard
- 2U or 4U Rack Mount Chassis integrates with ECTS2 Compliance Test Systems
- Windows Software for Voltage Dips, Interruptions and Variations Programming and Execution
- Meets 1 to 5 usec Rise / Fall Time for AC Voltage Dips
- Uses Mains Power or Generator for 100% AC Voltage
- User Programmable AC Source for 0%, 40%, 70% or 80% Dip Levels
- Single or Three Phase Version
- Supports currents up to 100 Arms
- Compatible with AFX, AZX and LMX² Series Power Sources
- USB Interface for Control
- Test Generator Verification Load Option - VDT100R

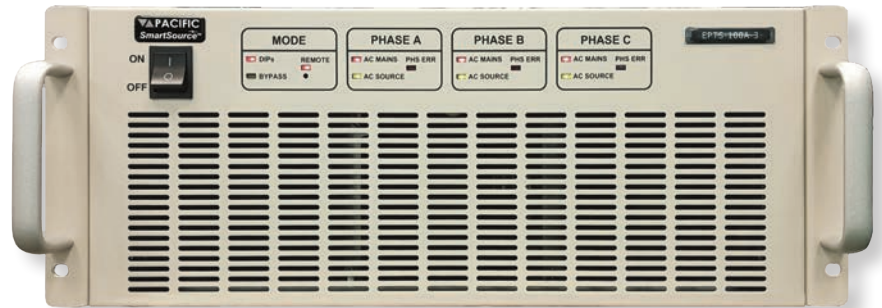

AC VOLTAGE DIPS



VOLTAGE UNBALANCE

OVERVIEW

The Pacific Power Source Electronic Power Transfer Switch module (EPTS) uses solid state electronic switch technology to meet the IEC61000-4-11, IEC61000-4-27 and IEC61000-4-34 Test requirements for voltage dips, short interruptions and voltage unbalance with voltage transition rates less than 5 usec. This supports full compliance testing of equipment for CE compliance.

Voltage Dips, Interrupts, Variations & Phase Unbalance

The EPTS Series units are designed to support full-compliance voltage dip testing for any dip level. It requires the use of AC mains or fixed AC generator for the nominal 100% test level and a programmable AC power source for the dip levels needed.

Power Connections

All power connections are made at the rear panel of the EPTS chassis. There are no user controls on the front other than the power On/Off switch. Status and Error indicators are provided for each phase. The EPTS generates a phase sync signal from the AC Main input to synchronize the programmable AC source. All control of the programmable AC power source and the EPTS is done using the included EptsGui IEC Test software.



FREQUENCY CONVERSION



AEROSPACE



R & D



MILITARY



MANUFACTURING



CUSTOM

Principle of Operation

The EPTS hardware is designed specifically to provide full compliance testing of products for CE marking. This requires support of the fast voltage rise and fall time called out in IEC test standards like IEC61000-4-11, IEC61000-4-27 or IEC61000-4-34.

This is accomplished by using an electronic power transfer switch controlled by the same IEC Test software that controls the AC dip level of the programmable power source. The nominal voltage to the unit under test is supplied by a second AC power supply or from the local mains.

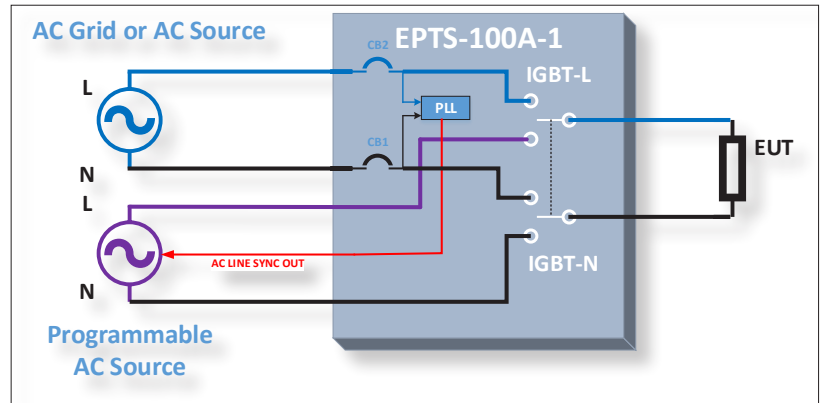

Electronic Power Transfer Switch -- Functional Diagram

EptsGui Test Software

The provided EptsGui test software is used to control the voltage dip or interrupt phase angle and duration. It also controls the programmable power source to set the correct dip level in percent of nominal. Test sequences and time intervals can be created and saved for repeated use by product category. Test setup parameters include:

- Nominal Voltage: Any AC grid voltage from 100 to 240Vac
- Product test class: 1, 2, 3 or X.
- Dip Level in % of Unom: 0%, 40%, 70%, 80% or user defined
- Dip duration in cycles: 0.5 to 10000 cycles (or msec)
- Test Interval Time: 1.000 to 100.0 seconds

At the end of a test, the user is prompted to provide the pass/fail classification based on observation or examination of the EUT. Available selections are a, b, c or d.

A test report is generated by the EMC Test software to document test parameters and observed EUT performance. Available report formats are Adobe PDF and Rich Text (RTF).

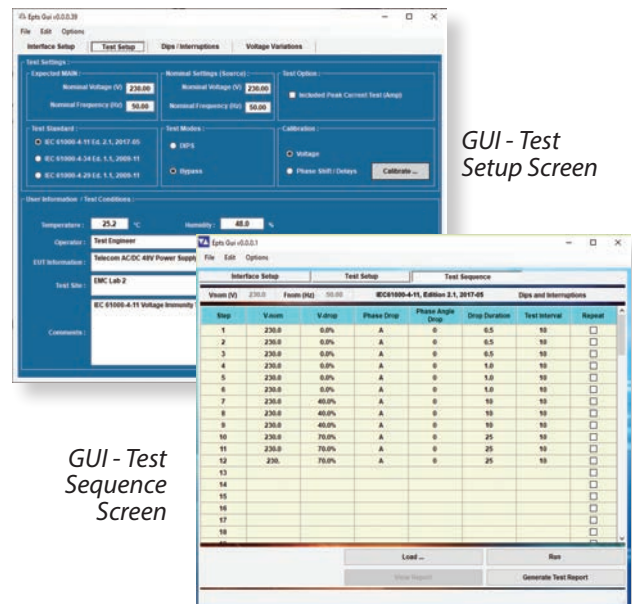

Choose the System Size You Need

Voltage Dips and Variation test systems come in all sizes and power levels. Entry level single phase systems start at up to 16A of current max.

A suitable power level LMX Series or AFX Series power source pairs with the EPTS-1-16A for a compact, bench top test systems.

For higher current needs and three phase applications, EPTS units start at 16Arms per phase and top out at 100Arms per phase.

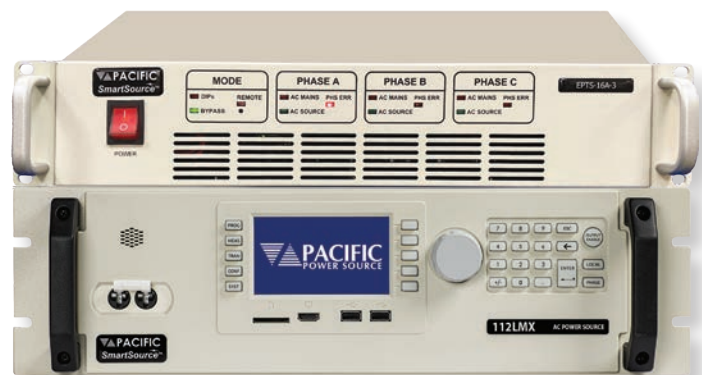

LMX Series Based AC Voltage Dips Test System

Voltage Rise and Fall Time Compliance

For full compliance to the IEC 61000-4-11/4-34 standards, the voltage rise and fall times as well as voltage over & under shoot **must** meet the stated standard requirements.

The EPTS meets both criteria into a 100 Ohm resistive load as can be seen in the scope traces shown.

These captures show a half cycle at 90° voltage dip to 0%, 40% and 70% of Unom. For each dip, the details for the rise and fall time are shown at a magnified time scale of 2 usec per division.

Voltage Dip to 0% of Unom @ 90°

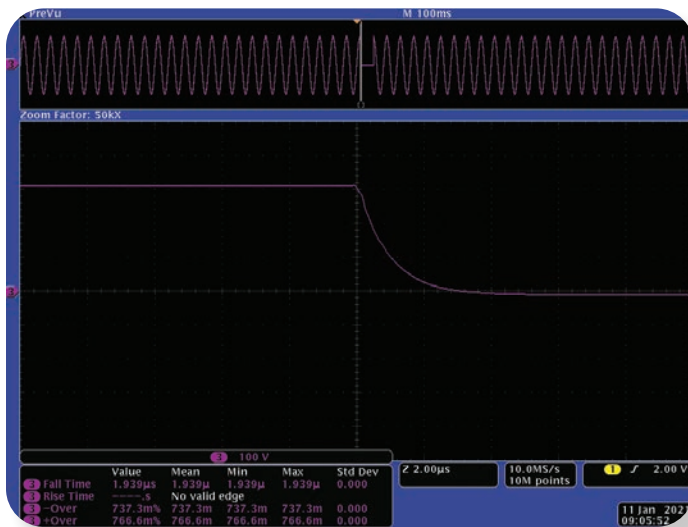
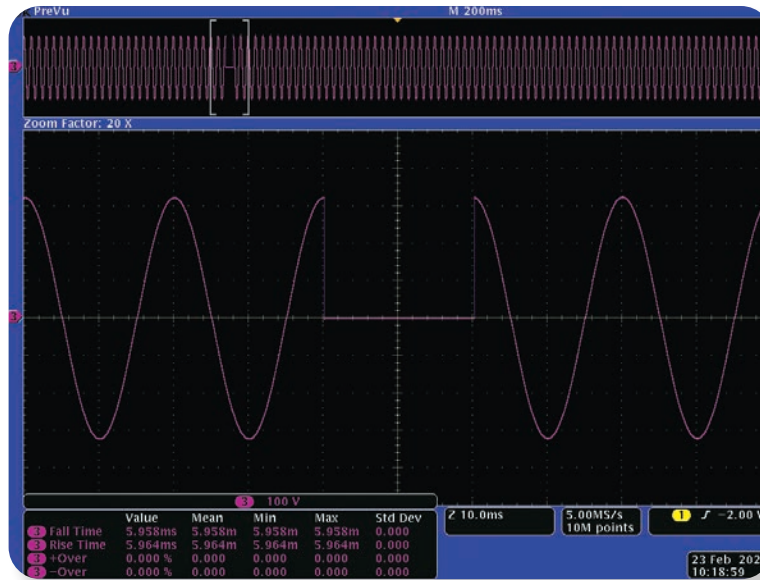

Fall Time < 5 µsec with no undershoot

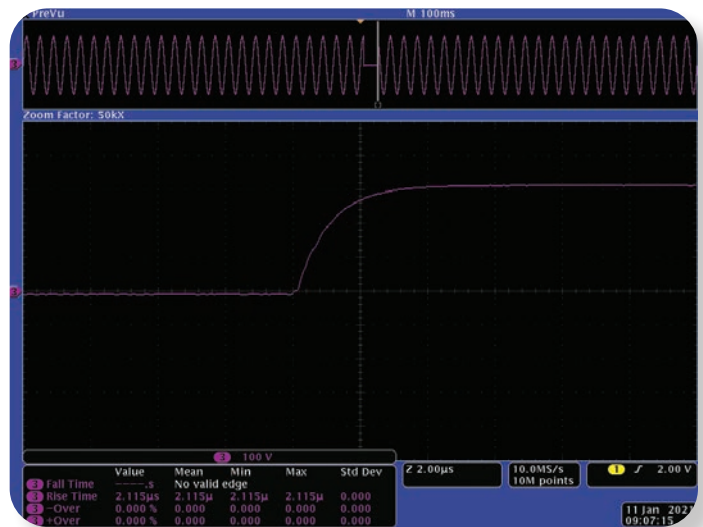

Rise Time < 5 µsec with no overshoot

IEC61000-4-11 & IEC61000-4-34 Three Phase AC Voltage Drop Methods Supported

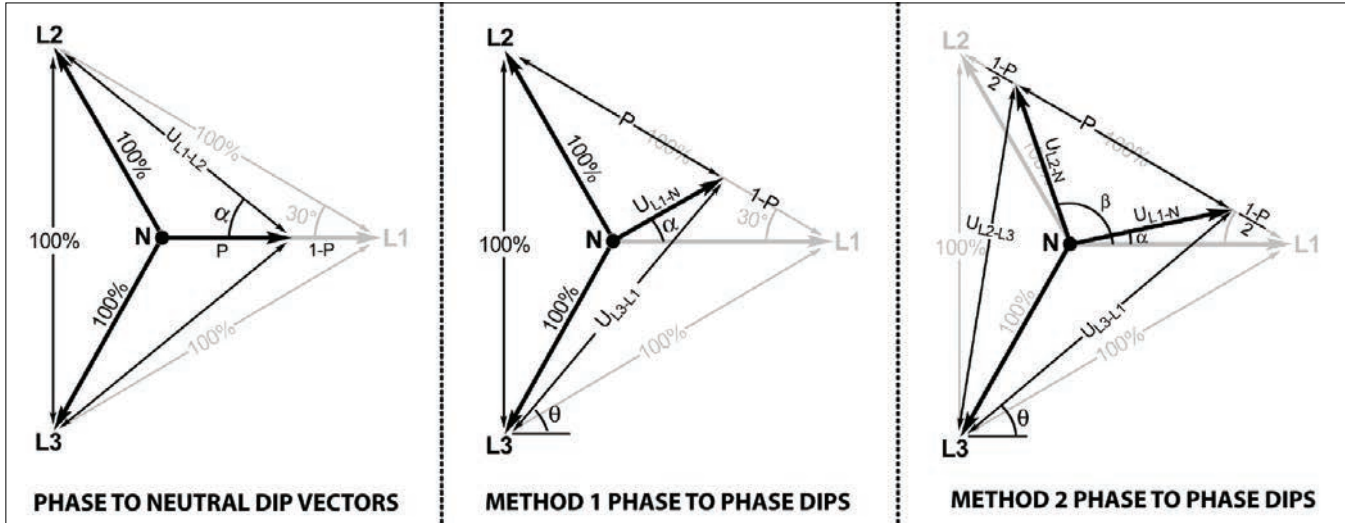

Three Phase Voltage Dips Vector Diagrams

For three phase EUT's, voltages dips must be applied using several phase vector methods in order to meet full compliance with the IEC61000-4-11 or IEC61000-4-34 test standard. This is covered in Annex C of the standard.

The required application of voltage dips are:

- Phase to Neutral Dips - One phase is dropped at a time, repeated for all phases. Phase angles between A, B and C remain constant.
- Phase to Phase Dips - Method 1: Two phases are dropped at a time by changing the amplitude of **one** phase amplitude and two phase angles. Repeated for each phase.

- Phase to Phase Dips - Method 2: Two phases are dropped at a time by changing the amplitude of **two** phase amplitudes and two phase angles. Repeated for each phase pair.

The image below shows the required three phase voltage dip vector diagrams.

The EPTS GUI software supports all allowable methods and comes with these amplitude and phase angle settings in its Voltage Dips library. Sample Voltage Dips screen from the EPTS Gui are shown at the bottom of this page.

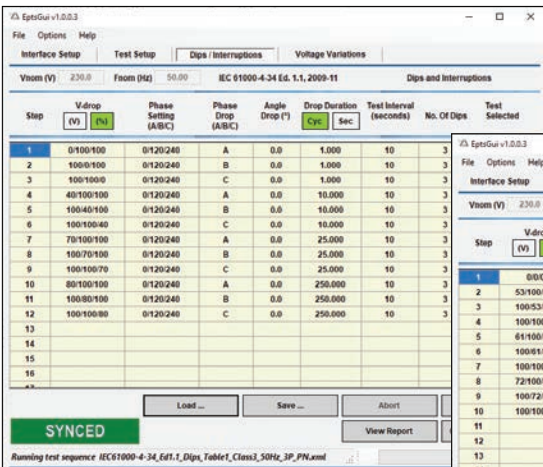

Phase to Neutral Voltage Dips Test Screen

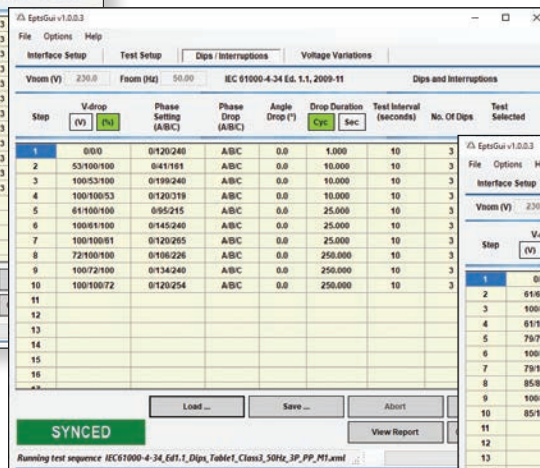

Phase to Phase Voltage Dips Method 1 Screen

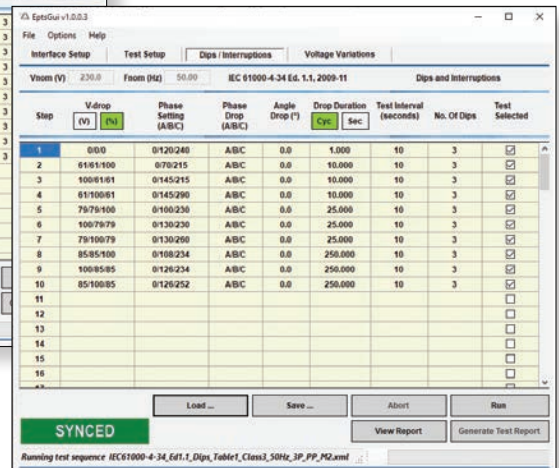

Phase to Phase Voltage Dips Method 2 Screen

IEC61000-4-27 Three Phase Voltage Unbalance Tests

Voltage Rise and Fall Time Compliance

For full compliance to the IEC 61000-4-27 Three phase AC voltage unbalance immunity test standards, the voltage rise and fall times as well as voltage over & under shoot **must** meet the stated standard requirements.

The EPTS meets both criteria into a 100 Ohm resistive load as can be seen in the scope traces shown.

These captures an unbalance event of 66% and 71% drops on phases B and C. The expanded scope screen shows this event at a 5µsec/division time scale illustrating the transition time is well below the 5µsec maximum allowed by the test standard.

Three Phase Voltage Unbalance 71 / 119 /66 @ 139° and 235°

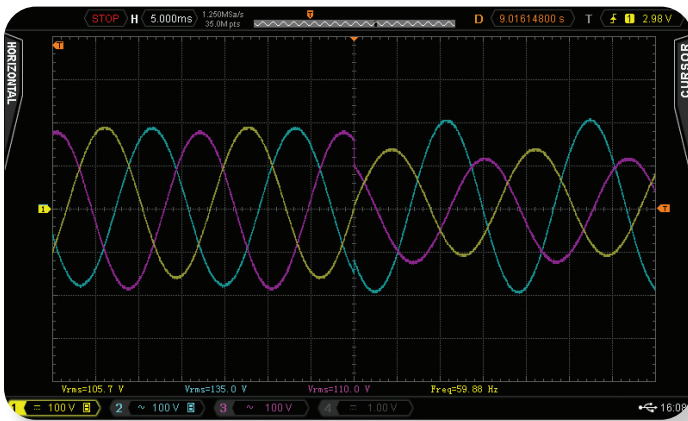

Voltage Unbalance Event

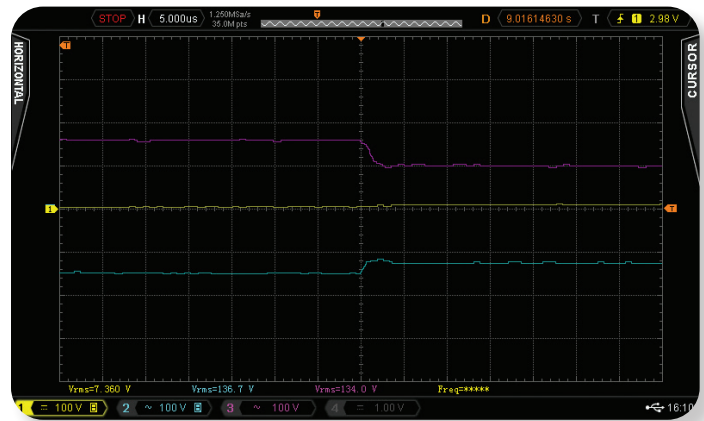

Rise Time < 5 µsec with no overshoot

Pre-Compliance Test Mode

The included Epts_Gui Windows software can be operated in pre-compliance mode in the absence of the EPTS power transfer switch hardware if needed.

This mode may be used for applications where full compliance is not required such as when performing in-house tests in preparation for submitting an EUT to a third party EMC lab for full compliance testing at a later time.

This allows the Epts_Gui to perform these tests using the programmable AC power source only and without the use of the local AC grid. In pre-compliance mode, the Epts_Gui uses the power source's transient system to perform all IEC61000-4 tests listed.

In this mode of operation, the voltage rise and fall times for voltage changes are considerably longer than 5 µsec so full compliance is not met.

Step	V-drop (V) (%)	Phase Setting (A/B/C)	Phase Drop (A/B/C)	Angle Drop (°)	Drop Duration (Cyc) (Sec)	Test Interval (seconds)	No. Of Dips	Test Selected
1	100.0/95.2/90.0	0/125/240	A/B/C	0.0	30.000	180	1	<input checked="" type="checkbox"/>
2	90.0/100.0/95.2	0/125/240	A/B/C	0.0	30.000	180	1	<input checked="" type="checkbox"/>
3	95.2/90.0/100.0	0/125/240	A/B/C	0.0	30.000	180	1	<input checked="" type="checkbox"/>
4	100.0/90.0/80.0	0/131/239	A/B/C	0.0	13.000	180	1	<input checked="" type="checkbox"/>
5	80.0/100.0/90.0	0/131/239	A/B/C	0.0	13.000	180	1	<input checked="" type="checkbox"/>
6	90.0/80.0/100.0	0/131/239	A/B/C	0.0	13.000	180	1	<input checked="" type="checkbox"/>
7	110.0/66.0/71.0	0/139/235	A/B/C	0.0	0.100	180	1	<input checked="" type="checkbox"/>
8	71.0/110.0/66.0	0/139/235	A/B/C	0.0	0.100	180	1	<input checked="" type="checkbox"/>
9	66.0/71.0/110.0	0/139/235	A/B/C	0.0	0.100	180	1	<input checked="" type="checkbox"/>
10								<input type="checkbox"/>
11								<input type="checkbox"/>
12								<input type="checkbox"/>
13								<input type="checkbox"/>
14								<input type="checkbox"/>
15								<input type="checkbox"/>
16								<input type="checkbox"/>

Full Compliance Test

SYNCED

Running test sequence IEC61000-4-27_Ed1.1_Class2_230V_50Hz_TestNumber1_2_3.xml

Technical Specifications

PARAMETER	IEC REQUIREMENT	EPTS-xxA
AC Voltage Range	230Vac (Europe) 100, 120 or 200Vac (Japan)	400Vac max.
Accuracy	< 5%	< 0.25%
Rise / Fall Time	1 to 5 usec	1 to 5 usec
Frequency	50.0 or 60.0 Hz ±2%	45.0 - 65.0 Hz
Phase error (3 phase)	< 5°	± 0.5°
Current		
IEC 61000-4-11, Max.	16A / Ph	100A / Ph ¹⁾
IEC 61000-4-34, Max.	75A / Ph	100A / Ph ¹⁾

Note 1: Max. Current based on EPTS model. Max. available is 100A.

AC INPUT	
AC Input Voltage (Bias)	
EPTS-1-16A / -3-16A	100V ~ 240 Vac
All other EPTS models	120Vac or 230Vac, 2W+G Note: AC input voltage must be specified at time of order
Frequency	50 / 60 Hz
AC Current	2.0 A

TEST STANDARDS SUPPORTED	
IEC 61000-4-11	AC - Voltage Dips and Interruptions
IEC 61000-4-34	AC - Voltage Dips and Interruptions
IEC 61000-4-27p	AC Voltage Unbalance (3 Phase mode only)
KS-C-9610-4-11	Korean equivalent of IEC 61000-4-11
KS-C-9610-4-34	Korean equivalent of IEC 61000-4-34

INTERFACES, INDICATORS & CONTROLS	
Connectors - Rear Panel	
Power Input	AC Mains, 1 or 3 Phases + Neutral AC Source, 1 or 3 Phases + Neutral
Power Output	To EUT, 1 or 3 Phases + Neutral
Control Interface	USB Device Type B, Rear panel
Line Sync	From AC Mains or Generator
Auxiliary I/O	DB9 Connector, Female, Rear panel
LED Indicators - Front Panel	
Mode	DIPS or Bypass
Phase Status	Mains or Source
Phase Error	For each Phase
Controls - Front Panel	
Power On/Off	Toggle Switch, Front panel

MECHANICAL & ENVIRONMENTAL	
Dimensions - EPTS-16A	
(HxWxD)	89 x 425 x 552 mm 3.5" x 16.7" x 20.5"
Dimensions - EPTS-32A, EPTS-75A & EPTS-100A	
(HxWxD)	178 x 432 x 670 mm 7" x 17" x 26.4"
Weight	
EPTS-16A-1	11.5 Kg / 25.4 lbs
EPTS-16A-1	12.0 Kg / 26.5 lbs
All other EPTS	42.5 Kg / 93.7 lbs
All EPTS Models	
Temperature	0 - 40° / 32 - 104°
Humidity	0-95 % non-condensing
Altitude	6500 ft / 2000 m (operating)

Dimensions

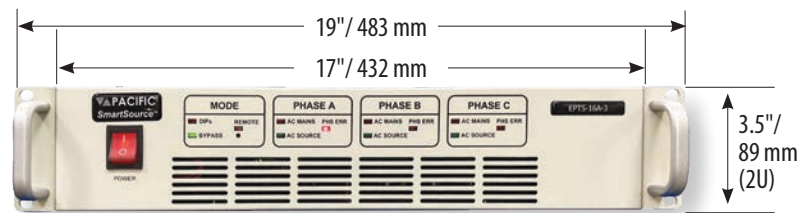

Front Panel View EPTS-16A-3 (2U Chassis)

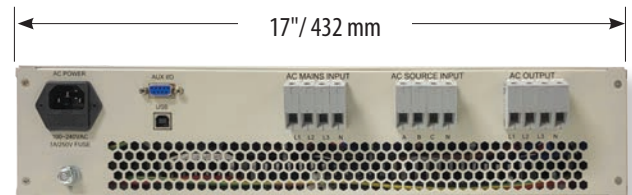

Rear Panel View EPTS-16A-3 (2U Chassis)

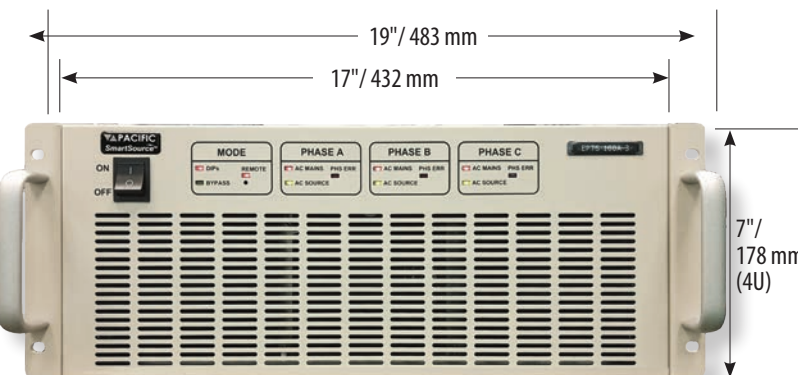

Front Panel View EPTS-100A-3 (4U Chassis)

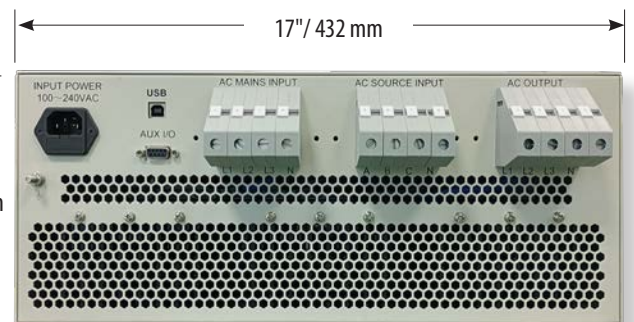

Rear Panel View EPTS-100A-3 (4U Chassis)

Generator Compliance Tables

IEC 61000-4-11 & IEC 61000-4-34	IEC REQUIREMENT	EPTS-100A-1 / EPTS-100A-3
Output Voltage at no load	Test Voltage $\pm 5\%$ of residual voltage	Test Voltage $\pm 0.5\%$
Output Voltage Change with load: 100% output, 0-16 A 80% output, 0-20 A 70% output, 0-23 A 40% output, 0-40 A	$< 5\%$ of U_T	Complies
Output Current Capability - IEC 61000-4-11	16 A @ 100% U_T 20 A @ 80% $U_T > 5$ sec 23 A @ 70% $U_T > 3$ sec 40 A @ 40% $U_T > 3$ sec	Complies
Output Current Capability - IEC 61000-4-11	Determined by Power Grid	AFX, AZX & LMX Series specifications meet or exceed requirements based on Model configuration
Peak Inrush Capability - IEC 61000-4-11	Not limited by generator	
Peak Inrush Capability - IEC 61000-4-34 16A - 50A Rated Equipment 50.1A - 100A Rated Equipment > 100A Rated Equipment	500A 1000 A Sufficient to maintain $\pm 10\%$ of U_T	
Voltage Over / Undershoot into 100 Ohm R Load	$< 5\%$ of U_T	$< 5\%$ of U_T
Voltage Rise & Fall Time into 100 Ohm R Load (See option VDT100R)	Between 1 and 5 usec for currents $< 75A$ Between 1 and 50 usec for currents $> 75A$	1 to 5 usec for currents $< 100 A$ 1 to 50 usec for currents $> 100 A$
Phase error (3 phase)	$< \pm 10^\circ$	$\pm 0.5^\circ$ (EPTS-100A-3)
Zero crossing control	$\pm 10^\circ$	$\pm 0.5^\circ$
Bypass Mode Current Rating	n/a	EPTS-x-16A: 16 Arms
		All other EPTS models: 100 Arms

VDT100R Load Option

The optional Voltage Dips Test Load (VDT100R) provides the required Very Low Inductance Resistive load required to verify compliance of the test generator to the IEC 61000-4-11 and IEC 61000-4-34 Voltage rise and fall time requirement. Supplied with a 24Vdc power supply. Switch selectable between 50 Ohms or 100 Ohms for either 120Vac or 240Vac use.



VDT100R Load Option



VDT100R Load Front Panel

VDT100R SPECIFICATIONS	
External Power Supply (included)	
AC Input	100 ~ 240 Vac, 50 ~ 60 Hz, 1.4 Arms
Ground	Chassis Ground stud, front panel
DC Output	24Vdc, 2.5Adc max., 60 Watts
Load Input	
AC Input Voltage	0 ~ 240 Vac, 45 ~ 66 Hz
Resistance	
Dual Ranges	100 Ohms / 50 Ohms
Max. Power	600 Watt - 100 Ohms range 1200 Watt - 50 Ohms range
Controls	
Range Selection	Toggle Switch (front panel)
Protections	
Over Temperature	Load Input opens up on over-temperature detection of internal heatsinks
Mechanical	
Dimensions (HxWxD)	170 x 190 x 402 / 364 mm
Depth incl/excl. AC terminals	6.7" x 7.5" x 15.8" / 14.3"
Weight (net)	6 Kg / 13.22 lbs
Cooling	Forced air fan cooled, Front intake, rear exhaust
Load Connection	Dual Compression Terminals, Rear Panel

ORDERING INFORMATION:

EPTS units are available in either single or three phase version and at different max. current ratings as shown in the table here.
Note: AC input voltage for 2U EPTS-16A-x is universal 100V~240Vac. AC input voltage for all 4U models must be specified at time of order as either 120Vac or 230Vac. (fixed setting).

Available Models & Options:

Model	Description
EPTS-16A-1	Electronic Power Transfer Switch, 16A, Single Phase
EPTS-16A-3	Electronic Power Transfer Switch, 16A/phase, Three Phase
EPTS-32A-1	Electronic Power Transfer Switch, 32A, Single Phase
EPTS-32A-3	Electronic Power Transfer Switch, 32A/phase, Three Phase
EPTS-75A-1	Electronic Power Transfer Switch, 75A, Single Phase
EPTS-75A-3	Electronic Power Transfer Switch, 75A/phase, Three Phase
EPTS-100A-1	Electronic Power Transfer Switch, 100A, Single Phase
EPTS-100A-3	Electronic Power Transfer Switch, 100A/phase, Three Phase
Options	Description
VDT100R	Test Generator Verification Low Inductance Resistive Load, 50 Ω & 100 Ω settable



ECTS2 EMC Test System with integrated EPTS-3-100A Voltage Dips Module

Service and Support

Pacific Power Source's customer support is second to none. Our Customer Support Program provides the training, repair, calibration, and technical support services that our customers value. So, in addition to receiving the right test equipment, our customers can also count on excellent support before, during and after the sale. With company owned support and service centers around the world, support is never far away.

Complete calibration and repair services are offered at our US, European and Chinese manufacturing facilities (see contact info below). Calibrations are to original factory specifications and are traceable to NIST (National Institute of Standards and Technology).

NORTH AMERICA

Pacific Power Source, Inc.
 Irvine, USA
 Phone: +1(949) 251-1800
 Fax: +1 (949) 756-0756
 Email: info@pacificpower.com
 Web: www.pacificpower.com

EUROPE

Pacific Power Source Europe GmbH.
 Kappelrodeck, Germany
 Phone: +49 7842 99722-20
 Fax: +49 7842 99722-29
 Email: info@pacificpower.eu
 Web: www.pacificpower.eu

CHINA

PPST Shanghai Co. Ltd.
 Shanghai, China
 Phone: +86-21-6763-9223
 Fax: +86-21-5763-8240
 Email: info@ppst.com.cn
 Web: www.ppst.com.cn

Proudly Represented by:

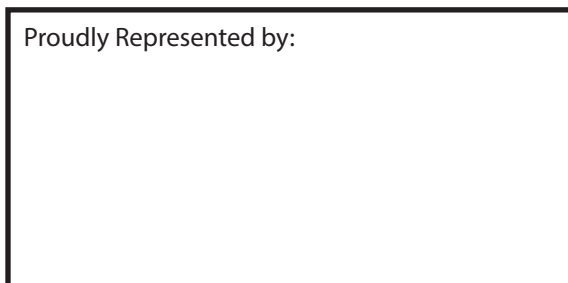

2802 Kelvin Avenue, Suite 100
 Irvine, CA 92614 -5897 USA
 Phone: +1 949.251.1800
 Fax: +1 949.756.0756
 Toll Free: 800.854.2433
 E-mail: sales@pacificpower.com
 Web: www.pacificpower.com