

upcstudio

MASTER THE POWER  
OF THE

WAVE

# UPC STUDIO OPERATIONS MANUAL

PPS PART No. 149050 – Rev.B

Version 2.0 • May 2018

# CONTENTS

1	Introducing UPC Studio .....	1
2	System Requirements .....	2
3	Getting Started .....	4
3.1	Main Window .....	4
3.2	Registering .....	5
4	Introducing UPC Studio .....	6
4.1	UPC Studio Connection Setup .....	6
4.1.1	Simulation Mode .....	8
4.2	UPC Studio Window .....	9
4.2.1	Operation .....	9
4.2.2	Toolbar Buttons .....	11
4.2.3	Link/Unlink .....	12
4.2.4	UPC Info .....	12
4.2.5	Event Status Panel .....	13
4.3	Waveform Editor .....	13
4.3.1	Waveforms Table .....	14
4.3.2	Toolbar buttons .....	15
4.3.3	Amplitude Table .....	15
4.3.4	Selection .....	16
4.3.5	Waveform Graph Context Menu .....	16
4.3.6	Importing, Exporting and Printing Waveforms .....	18
4.3.7	Harmonic Synthesis .....	20
4.3.8	Harmonic Analysis .....	21
4.3.9	Ring Edit Window .....	23
4.3.10	Event Status Panel .....	25
4.4	Output Sequence Browser .....	25
4.4.1	Stored UPC Programs Table .....	26
4.4.2	Toolbar Buttons .....	27
4.4.3	Folder and File Views .....	28
4.4.4	Event Status Panel .....	28
4.5	Output Sequence Window .....	29
4.5.1	Toolbar Buttons .....	30
4.5.2	Execute Button and Elapsed Time Indicator .....	30
4.5.3	Transient Button and Elapsed Time Indicator .....	30

4.5.4	Transient Segments .....	31
4.5.5	Cycle Reset.....	32
4.5.6	Out of Range Values .....	32
4.5.7	Transient Graph .....	33
4.5.8	Link/Unlink .....	34
4.5.9	Event Status Panel .....	34
4.5.10	CRC .....	34
4.5.11	Comments.....	34
4.5.12	Cycle Based Transient Checkbox .....	34
4.5.13	Transient Waveform Auto RMS Checkbox .....	34
4.5.14	Number of Events .....	35
4.5.15	Transient Event Progress.....	35
4.6	Saving Output Sequences.....	35
4.6.1	Save Window.....	36
4.6.2	Save and Execute Window.....	37
4.7	Adjust Window .....	38
4.7.1	Ramp .....	38
4.7.2	Pending Change.....	39
4.7.3	Max Vrms Indicator .....	39
4.7.4	Out of Range .....	39
4.7.5	Slew.....	39
4.7.6	Inc/Dec Bumpers .....	40
4.7.7	Limit Min/Max .....	40
4.8	Event Status Panel .....	40
4.8.1	Events.....	41
4.8.2	Execution State.....	42
4.8.3	Executing Program .....	42
<b>5</b>	<b>Test Manager .....</b>	<b>43</b>
5.1.1	Getting Started .....	44
5.1.2	Opening and Creating Test Sequences and Test Plans.....	44
5.1.3	Test Sequence Window .....	44
5.1.4	Title Bar .....	45
5.1.5	Objective Tab, Context Area and Context Menu .....	45
5.1.6	Preferences Tab.....	46
5.1.7	Step Value/Comment and Step Result Tabs .....	47
5.1.8	Run State .....	47
5.1.9	Run Toolbar.....	48
5.2	Time and Progress Indicators .....	48

5.2.1	Step Table .....	49
5.2.2	Event Status Panel .....	49
5.2.3	File Menu and Toolbar .....	49
5.2.4	Step Table: Test Sequence Step Table .....	49
5.2.5	Adding or Removing Steps.....	50
5.2.6	Step Table Columns .....	51
5.2.7	Step Types: Control .....	52
5.3	Meter .....	53
5.3.1	Waveform Metering.....	57
5.4	Script .....	58
5.4.1	Test Manager Object Reference .....	59
5.4.2	Run Object .....	59
5.4.3	Step Object .....	63
5.4.4	Report Object .....	65
5.4.5	UPC Object.....	68
5.4.6	Rich Textbox Objects .....	70
5.5	Steady State .....	70
5.5.1	Timer .....	72
5.6	Transient.....	72
5.6.1	Infinite Transient .....	74
5.6.2	User Input.....	76
5.7	Report Field .....	78
5.7.1	Comment .....	78
5.7.2	User Input Window .....	79
5.8	User Prompt .....	80
5.8.1	User Prompt Window .....	81
5.9	VISA .....	82
5.10	Test Plan Window .....	83
5.10.1	Title Bar .....	84
5.10.2	Objective Tab, Context Area and Context Menu .....	84
5.10.3	Preferences Tab.....	85
5.10.4	Step Info and Step Result Tabs.....	85
5.10.5	Run State .....	86
5.10.6	Run Toolbar .....	87
5.10.7	Time and Progress Indicators .....	87
5.10.8	Step Table.....	88
5.10.9	Event Status Panel .....	88
5.10.10	File Menu and Toolbar .....	88

5.11	Test Plan Step Table .....	88
5.11.1	Adding or Removing Steps.....	89
5.11.2	Step Table Columns .....	90
5.11.3	Test Sequence File Status.....	90
5.12	Test Report .....	91
5.12.1	Toolbar and File Menu.....	91
5.13	Test Results.....	92
5.13.1	Test Plan Step Title .....	93
5.14	Controlling Report Information.....	93
<b>6</b>	<b>Introducing UPC Control .....</b>	<b>94</b>
6.1	UPC Control Connection Setup .....	94
6.2	Simulation Mode .....	95
6.3	UPC Control Window .....	96
6.3.1	Operation .....	96
6.3.2	Info Panel.....	97
6.3.3	Setup Panel .....	98
6.3.4	kFactors Panel .....	99
6.3.5	Programs Panel.....	100
6.3.6	Waveforms Panel .....	102
6.3.7	Prog-Zo Cal Panel .....	103
6.3.8	Text Dump Panel .....	104
6.3.9	Probe and Capture Panel .....	105
<b>7</b>	<b>Control and Event Panels .....</b>	<b>107</b>
7.1	Control Panel .....	107
7.2	Event Panel .....	108
7.3	Program Status .....	108
<b>8</b>	<b>Printing .....</b>	<b>109</b>
<b>9</b>	<b>Saving .....</b>	<b>110</b>
<b>10</b>	<b>Program Preview .....</b>	<b>111</b>
10.1	View Palette .....	112
10.2	Splitter Bar .....	112
10.3	Table View .....	112
10.4	Graph View and Controls .....	113
10.5	Info Bar.....	114
10.6	Printing and Exporting .....	114
10.7	Updating Values.....	114
<b>11</b>	<b>UPC Meter V/I Display .....</b>	<b>115</b>
11.1	V/I Display .....	115

11.2	Refresh and Toolbar Display Buttons .....	116
11.3	V/I Display Menu and Measurement Templates .....	116
11.4	File Menu .....	118
<b>12</b>	<b>UPC Meter Waveform Display .....</b>	<b>119</b>
<b>13</b>	<b>UPC Meter Harmonics Display .....</b>	<b>120</b>
13.1	Bar View .....	120
13.2	Grid View .....	121
13.3	Pass/Fail .....	121
13.4	Limits File .....	122
<b>14</b>	<b>Data Log .....</b>	<b>124</b>
<b>15</b>	<b>Reading UPC Settings .....</b>	<b>127</b>
<b>16</b>	<b>Writing UPC Settings .....</b>	<b>129</b>
<b>17</b>	<b>UPC Settings Interface Connection .....</b>	<b>131</b>
<b>18</b>	<b>Troubleshooting Guidelines .....</b>	<b>134</b>
<b>19</b>	<b>Firmware Versions .....</b>	<b>134</b>
19.1	UPC-12/32 Firmware .....	134
19.2	UPC-1/3 Firmware .....	135
<b>20</b>	<b>System Resources .....</b>	<b>137</b>



**PACIFIC POWER SOURCE, INC.  
17692 FITCH  
IRVINE CALIFORNIA 92614, USA  
949-251-1800**

1. This License Agreement permits you to use one copy of the enclosed software program (the "SOFTWARE") on a single computer. If you have a multi-user license for the SOFTWARE, then at any time you may have as many copies of the SOFTWARE in use as are permitted by the multi-user license. The SOFTWARE is in "use" on a computer when it is loaded into temporary memory (i.e., RAM) or installed into permanent memory (e.g., hard disk, CD-ROM, or other storage device). If the anticipated number of users of the SOFTWARE could exceed the number of users permitted by applicable licenses, then you must have a reasonable mechanism or process in place to ensure that the number of persons using the SOFTWARE does not exceed the number permitted by the applicable licenses. All rights not expressly granted to you in this Agreement are reserved to PACIFIC POWER SOURCE.

2. COPYRIGHT. The SOFTWARE is owned by PACIFIC POWER SOURCE and is protected by United States copyright laws and international treaty provisions. Therefore, you must treat the SOFTWARE like any other copyrighted material. You may, however, either (a) make one copy of the SOFTWARE solely for backup or archival purposes, or (b) transfer the SOFTWARE to a single hard disk, provided you keep the original solely for backup or archival purposes. You may not copy the written materials accompanying the SOFTWARE.

3. OTHER RESTRICTIONS. You may not reverse engineer, decompile, or disassemble the SOFTWARE. You may transfer the SOFTWARE to a third party provided that after each transfer you do not retain any copies of the SOFTWARE, including all upgrades that you may have received, nor retain any of the written materials accompanying the SOFTWARE.

4. OPERATING SYSTEM OPTIONS (CD-ROM MEDIA). If the SOFTWARE is distributed with multiple versions on a CD-ROM for compatibility with different operating systems, your license grant extends to using only the applicable version for your operating system.

#### LIMITED WARRANTY

Pacific Power Source warrants, for your benefit alone, that (a) the SOFTWARE will perform substantially in accordance with the accompanying written materials, and (b) the medium on which the SOFTWARE is recorded will be free from

defects in materials and workmanship under normal use and service for a period of ninety (90) days from the date of receipt. Some states/jurisdictions do not allow limitations on duration of an implied warranty, so the above limitation may not apply to you.

#### CUSTOMER REMEDIES

Pacific's entire liability and your sole and exclusive remedy shall be, at Pacific's option, either (a) return of the fees paid, or (b) repair or replacement of the SOFTWARE that does not meet Pacific's Limited Warranty stated above, and which is returned to Pacific Power Source. The Limited Warranty is void if failure of the SOFTWARE has resulted from accident, abuse, or misapplication. Any replacement SOFTWARE will be warranted for the remainder of the original warranty period or thirty (30) days, whichever is longer.

NO OTHER WARRANTIES. EXCEPT AS EXPRESSLY SET FORTH ABOVE, THE SOFTWARE AND THE DOCUMENTATION ARE PROVIDED "AS IS" WITHOUT WARRANTY OF ANY KIND, AND NO OTHER WARRANTIES, EITHER EXPRESSED OR IMPLIED, ARE MADE WITH RESPECT TO THE SOFTWARE, INCLUDING BUT NOT LIMITED TO ANY IMPLIED WARRANTIES OF MERCHANTABILITY OR FITNESS FOR A PARTICULAR PURPOSE OR ANY OTHER WARRANTIES THAT MAY ARISE FROM USAGE OF TRADE OR COURSE OF DEALING. PACIFIC POWER SOURCE DOES NOT WARRANT, GUARANTEE, OR MAKE ANY REPRESENTATIONS REGARDING THE USE OF OR THE RESULTS OF THE USE OF THE SOFTWARE OR THE DOCUMENTATION IN TERMS OF CORRECTNESS, ACCURACY, RELIABILITY, OR OTHERWISE AND DOES NOT WARRANT THAT THE OPERATION OF THE SOFTWARE WILL BE UNINTERRUPTED OR ERROR FREE. PACIFIC POWER SOURCE EXPRESSLY DISCLAIMS ANY WARRANTIES NOT STATED HEREIN.

PACIFIC POWER SOURCE ASSUMES NO LIABILITY FOR CONSEQUENTIAL DAMAGES. THE ENTIRE LIABILITY OF PACIFIC POWER SOURCE AND ITS DEALERS, DISTRIBUTORS, OFFICERS, DIRECTORS, AGENTS, AND EMPLOYEES ARE SET FORTH ABOVE. TO THE MAXIMUM EXTENT PERMITTED BY APPLICABLE LAW, IN NO EVENT SHALL PACIFIC OR ITS SUPPLIERS BE LIABLE FOR ANY DAMAGES INCLUDING ANY SPECIAL, DIRECT, INDIRECT, INCIDENTAL, EXEMPLARY, OR CONSEQUENTIAL DAMAGES, EXPENSES, LOST PROFITS, LOST SAVINGS, BUSINESS



INTERRUPTION, LOST BUSINESS INFORMATION, OR ANY OTHER DAMAGES ARISING OUT OF THE USE OR INABILITY TO USE THE SOFTWARE OR THE DOCUMENTATION EVEN IF PACIFIC HAS BEEN ADVISED OF THE POSSIBILITY OF SUCH DAMAGES. YOU ACKNOWLEDGE THAT THE LICENSE FEE REFLECTS THIS ALLOCATION OF RISK. Because some states/jurisdictions do not allow the exclusion or limitation of liability for consequential or incidental damages, the above limitation may not apply to you.

**WARNING**

PACIFIC PRODUCTS ARE NOT DESIGNED WITH COMPONENTS AND TESTING FOR A LEVEL OF RELIABILITY SUITABLE FOR USE IN THE DIAGNOSIS AND TREATMENT OF HUMANS OR AS CRITICAL COMPONENTS IN ANY LIFE SUPPORT SYSTEMS WHO'S FAILURE TO PERFORM CAN REASONABLY BE EXPECTED TO CAUSE SIGNIFICANT INJURY TO A HUMAN.

RELIABILITY OF OPERATION OF THE SOFTWARE CAN BE IMPAIRED BY ADVERSE FACTORS, INCLUDING BUT NOT LIMITED TO FLUCTUATIONS IN ELECTRICAL POWER SUPPLY, COMPUTER HARDWARE MALFUNCTIONS, COMPUTER OPERATING SYSTEM SOFTWARE FITNESS, FITNESS OF COMPILERS AND DEVELOPMENT SOFTWARE USED TO DEVELOP AN APPLICATION, INSTALLATION ERRORS, SOFTWARE AND HARDWARE COMPATIBILITY PROBLEMS, MALFUNCTIONS OR FAILURES OF ELECTRONIC MONITORING OR CONTROL DEVICES, TRANSIENT FAILURES OF ELECTRONIC SYSTEMS (HARDWARE AND/OR SOFTWARE), UNANTICIPATED USES OR MISUSES, OR ERRORS ON THE PART OF THE USER OR APPLICATION DESIGNER. (ADVERSE FACTORS SUCH AS THESE ARE HEREAFTER COLLECTIVELY TERMED "SYSTEM FAILURES.")

ANY APPLICATION WHERE A SYSTEM FAILURE WOULD CREATE A RISK OF HARM TO PROPERTY OR PERSONS (INCLUDING THE RISK OF BODILY INJURY AND DEATH) SHOULD NOT BE RELIANT SOLELY UPON ELECTRONIC MONITORING DUE TO THE RISK OF SYSTEM FAILURE. TO AVOID DAMAGE, INJURY OR DEATH, THE USER OR APPLICATION DESIGNER MUST TAKE REASONABLY PRUDENT STEPS TO PROTECT AGAINST SYSTEM FAILURES, INCLUDING BUT NOT LIMITED TO BACK-UP OR SHUT DOWN MECHANISMS.

**WARNING**



THIS AGREEMENT IS GOVERNED BY THE LAWS OF THE STATE OF CALIFORNIA, EXCLUSIVE OF ANY PROVISIONS OF THE UNITED NATIONS CONVENTION ON THE INTERNATIONAL SALE OF GOODS, AND WITHOUT REGARD TO PRINCIPLES OF CONFLICTS OF LAW, AND CONSTITUTES THE COMPLETE AGREEMENT BETWEEN YOU AND PACIFIC POWER SOURCE. IT SUPERSEDES ANY ORAL OR WRITTEN PROPOSALS, PRIOR AGREEMENTS, PURCHASE ORDERS OR ANY OTHER COMMUNICATION BETWEEN YOU AND PACIFIC POWER SOURCE RELATING TO THE SUBJECT MATTER OF THIS AGREEMENT. If any action is brought by either party to this Agreement against the other regarding the subject matter hereof, the prevailing party shall be entitled to recover, in addition to any relief granted, reasonable attorney fees and court costs. If any provision of this Agreement is held invalid, the offending clause will be modified so as to be enforceable and, as modified, shall be fully enforced, and the remainder of this Agreement will continue in full force and effect.

Contractor/manufacturer is Pacific Power Source, Inc., 17692 Fitch, Irvine, CA. 92614

# 1 Introducing UPC Studio

UPC Studio provides a complete graphical interface for your UPC controller and power source. It includes safeguards to protect your load and guides you into entering values that are appropriate for your power source. UPC Studio can be used to directly control your UPC through the remote interface or "offline" using simulation files. In addition, you can monitor the status of your power source and view metered values like output voltage, load current, waveforms and harmonics.

UPC Studio is a sub-set of a number of Utilities included in the UPC Manager program. UPC Manager allows you to control your power source from your PC using an available serial port or GPIB interface. The following lists some of the features of UPC Manager:

- View and print UPC metered values including waveforms and harmonics (Firmware option).
- Export metered values to Microsoft™ Excel™ (\*.csv file).
- Monitor power source status.
- Create arbitrary waveforms.
- Connect to a virtual UPC using simulation files.
- Update UPC settings offline using simulation files.
- Capture and record commands and queries sent to your UPC.
- Create and execute output sequences based on time or cycle variations of voltage or frequency.
- Preview power source outputs during steady state or transient operation.
- Read all settings in your UPC controller and save them to a file on your PC (backup).
- Send settings from a file on your PC to your UPC controller (restore).
- Use your PC to view, edit and print UPC settings

Refer to your UPC Programmable Controller Operation Manual for additional information on UPC operation and the values of the various UPC settings.

## 2 System Requirements

UPC Studio/Manager requires:

- Windows XP/2000, Windows 10 32bits / 64bits
- An available COM (serial) port, USB to RS232 Adapter with DB9 to DB25 adaptor cable or GPIB port (not required for simulation mode)
- Serial cable or GPIB interface cable (not required for simulation mode)
- NI-VISA software
- If you are using a GPIB interface, you also need NI-488.2 software.

NI-VISA and NI-488.2 software are available for free download from the National Instruments web site at <http://www.ni.com/support/>.

# upc studio

## Program Map

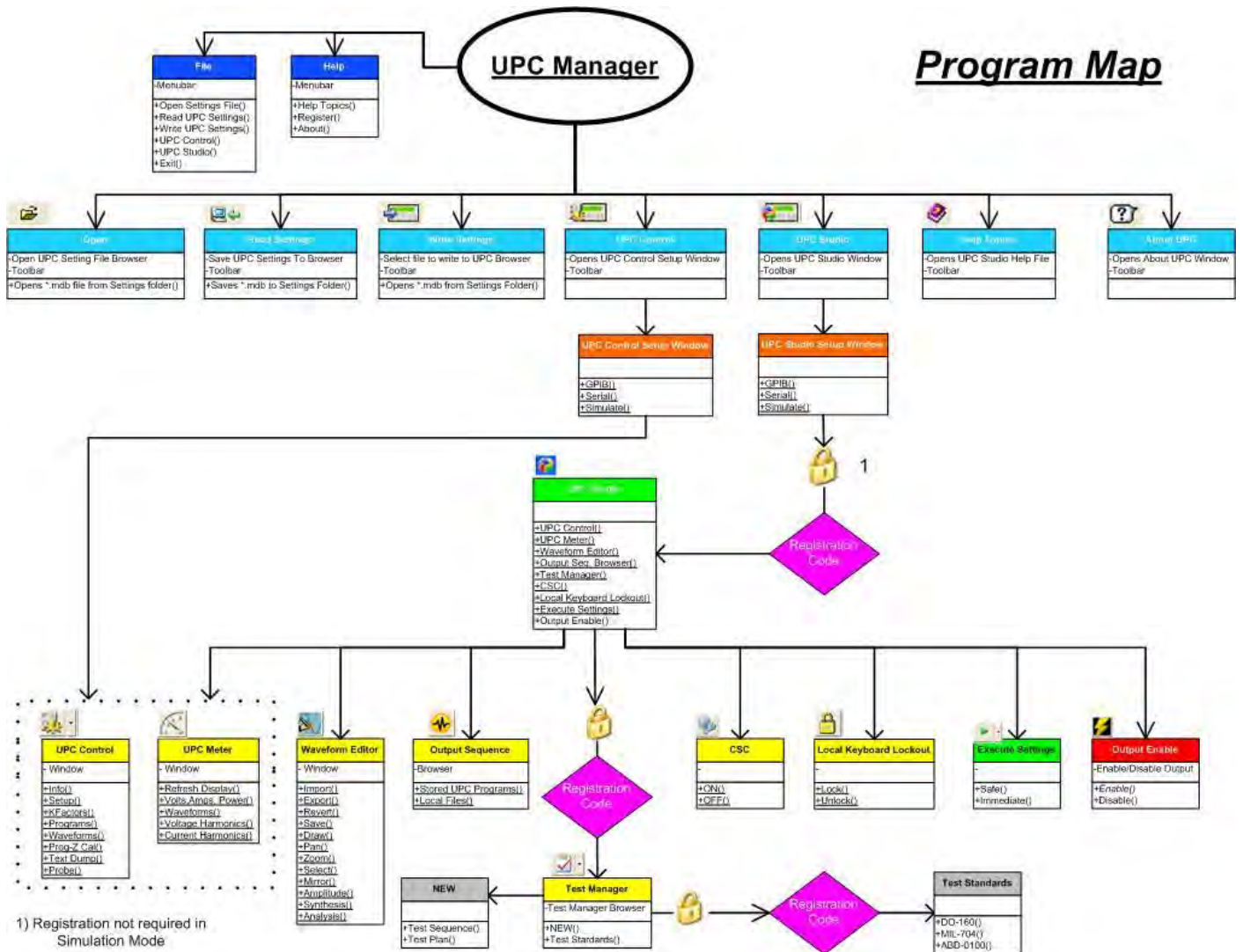

## 3 Getting Started

To start UPC Manager, click **Start**, then click **Programs**, then choose **Pacific Power Source** then **UPC Manager**.

### 3.1 Main Window

UPC Manager is an MDI (Multiple Document Interface) application. As show below, the main window includes a toolbar. The toolbar allows you to perform the operations listed. The **Open/Import**, **Save/Export** and **Print** items are only enabled when a settings file or UPC window is open.

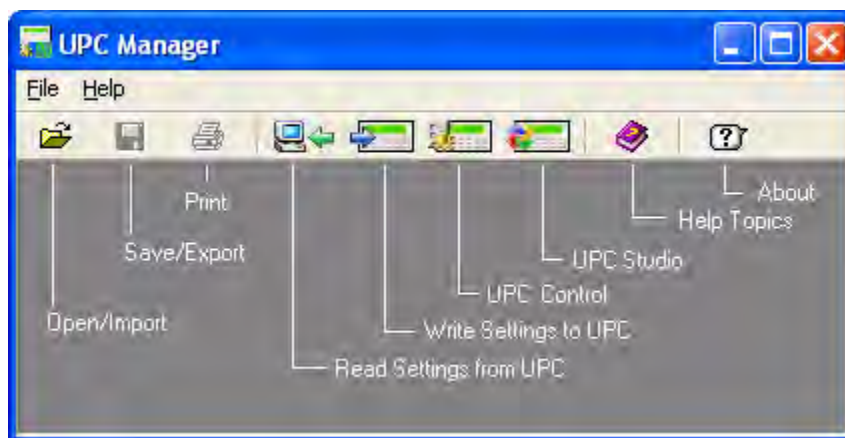

Click below for more information on a particular toolbar item:

- **Introducing UPC Studio** - UPC Studio provides a complete graphical interface for your UPC controller and power source.
- **Introducing UPC Control**- The UPC Control window allows you to directly control your UPC through the remote interface.
- **Reading UPC Settings** - The Read UPC Settings window stores all the values in your UPC to a file on your PC.
- **Writing UPC Settings** - The Write UPC Settings window sends values from a settings file on your PC to your UPC.
- Save Settings to Text File
- Print
- Write Settings to UPC
- Registering
- About (System Resources )

## 3.2 Registering

Some UPC Studio/Manager features require a registration code. If a dialog appears that explains that feature is unavailable for your UPC, contact Pacific Power Source and provide your UPC serial number (also shown in the dialog box) to obtain the necessary registration code. To enter the registration code, choose Register from the Help menu.

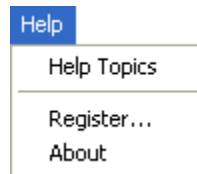

Enter the registration code in the dialog box that appears. To minimize entry errors, you can copy (Ctrl+C) and paste (Ctrl+V) the code you received.

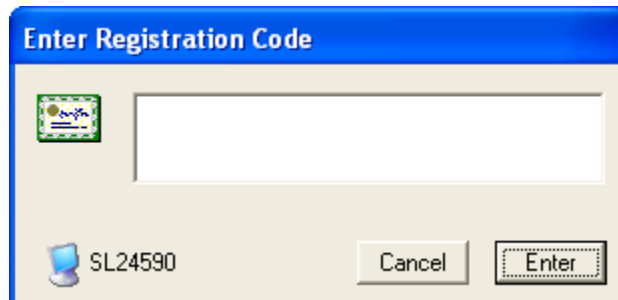

## 4 Introducing UPC Studio

UPC Studio provides a complete graphical interface for your UPC controller and power source. It includes safeguards to protect your load and guides you into entering values that are appropriate for your power source. UPC Studio can be used to directly control your UPC through the remote interface or "offline" using simulation files. In addition, you can monitor the status of your power source and view metered values like output voltage, load current, waveforms and harmonics.

UPC Studio features:

- Connect to your UPC using a Serial port or GPIB interface card.
- Easily change power source parameters like output voltage, frequency etc.
- View and print UPC metered values including waveforms and harmonics (Firmware option) Export metered values to Microsoft Excel (\*.csv file)
- Monitor power source status.
- Create arbitrary waveforms.
- Create and execute output sequences based on time or cycle variations of voltage or frequency.
- Connect to a virtual UPC using simulation files.
- Update UPC settings offline using simulation files.
- Capture and record commands and queries sent to your UPC.
- Preview power source outputs during steady state or transient operation.

Use the UPC Studio Connection Setup window to connect to your UPC.

### 4.1 UPC Studio Connection Setup

Before UPC Studio can communicate with your UPC, you must specify the interface connection. The steps below describe how to connect to your UPC.



# upcstudio

1. Press the **UPC Studio** icon in the toolbar
2. The **UPC Studio Setup** window appears as shown below. In this example, the **Serial** interface tab was selected. Click on the tab corresponding to the interface connection of your UPC then enter the appropriate communication settings. You can view or change the remote interface settings currently programmed in your UPC by pressing **FN 3, 3** on the UPC front panel.
3. Specify the cache file that will be created when controlling your UPC. The default cache file name automatically assigned for you should be fine for most applications.
4. After you specify the appropriate connection settings, press the **Connect** button.

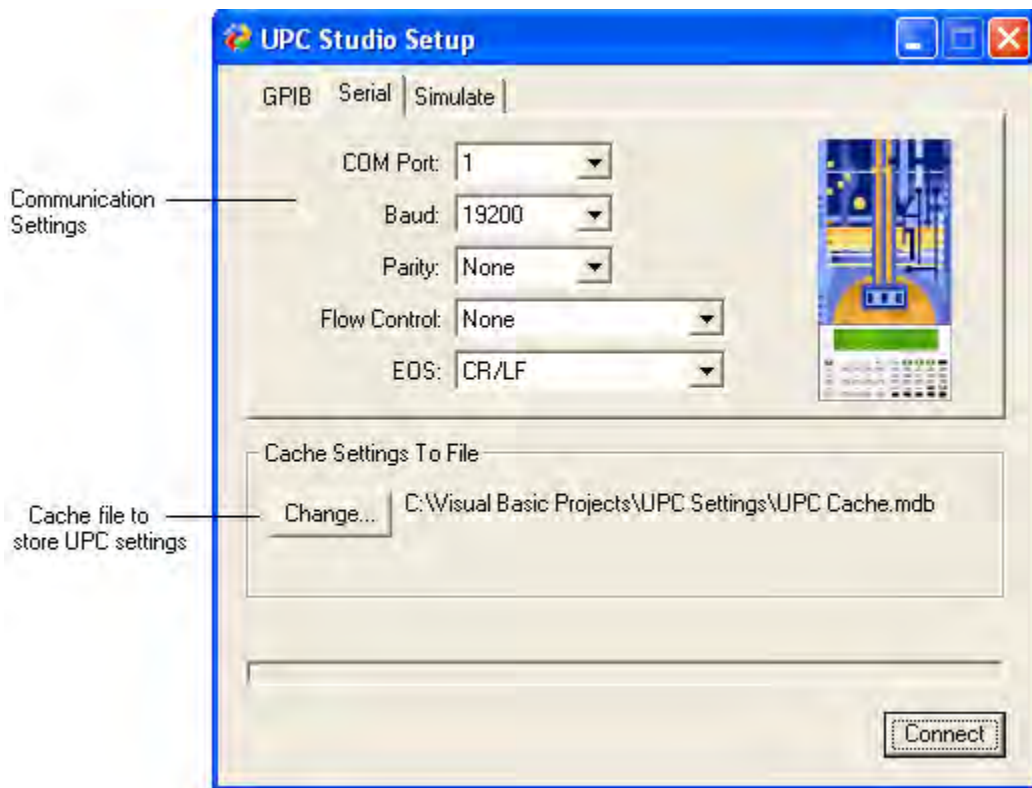

The progress of connecting is shown in the window. When the connection process completes, the main UPC Studio window appears. Also a UPC Meter window appears that allows you to view all UPC measured values.

## 4.1.1 Simulation Mode

In addition to being able to connect to your UPC using either a GPIB or Serial interface, you can connect to a virtual UPC using a simulation file. Simulation files are nothing more than UPC Settings files and can be created using the Read UPC Settings icon in the toolbar. Simulation files should be stored in the "Simulate" folder located in the same directory as the UPC Manager application (typically "C:\Pacific Power Source\UPC Manager\Simulate").

Simulation files are handy if you want to run your UPC "off-line". You can then upload your changes to your UPC using the Write UPC Settings icon in the toolbar. Shown below is an example of the UPC Studio Setup window with the **Simulate** tab selected.

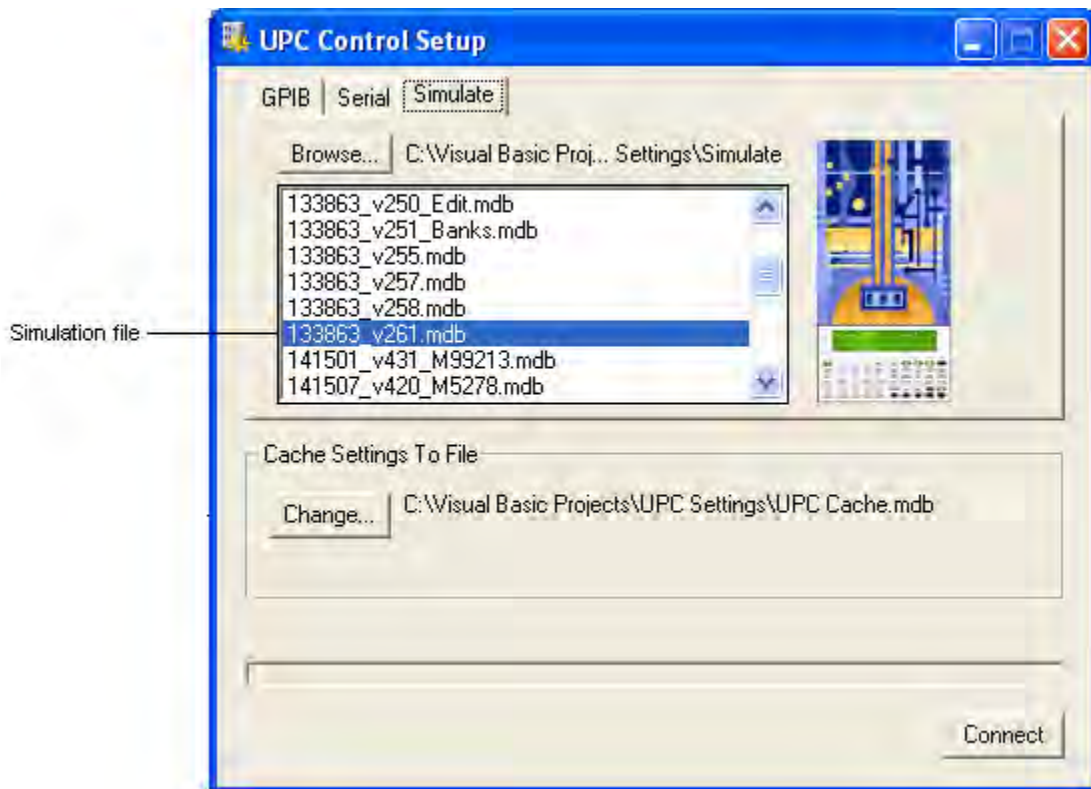

## 4.2 UPC Studio Window

After you connect to your UPC using the UPC Studio Setup window, the main UPC Studio window appears as shown below. The title bar of the window shows the interface connection used to connect to your UPC. A UPC Meter window is also associated with the main UPC Studio window.

### 4.2.1 Operation

The UPC Studio window shows the output values presently executing in your UPC. Changes you make to the **CSC**, **Lock** and **Output Enable** buttons in the toolbar immediately take affect. For all other items, the change is "pending" until you press the **Execute** button. This provides a safeguard to protect the load and allows you to review all the changes before updating your UPC. Whenever a change is pending, the bold text associated with that item flashes white. You can discard pending changes by choosing "Cancel" from the execute button drop down menu. If you want changes to take effect immediately, choose "Immediate" from the Execute button drop down menu. Enter "DANGER" when you are prompted for a password.

Some items in the window shown below only apply to certain factory installed options and may not be available for your UPC. Right-clicking anywhere in the Frequency section or the Volts or Degree table cells opens the Adjust window.

# upcstudio

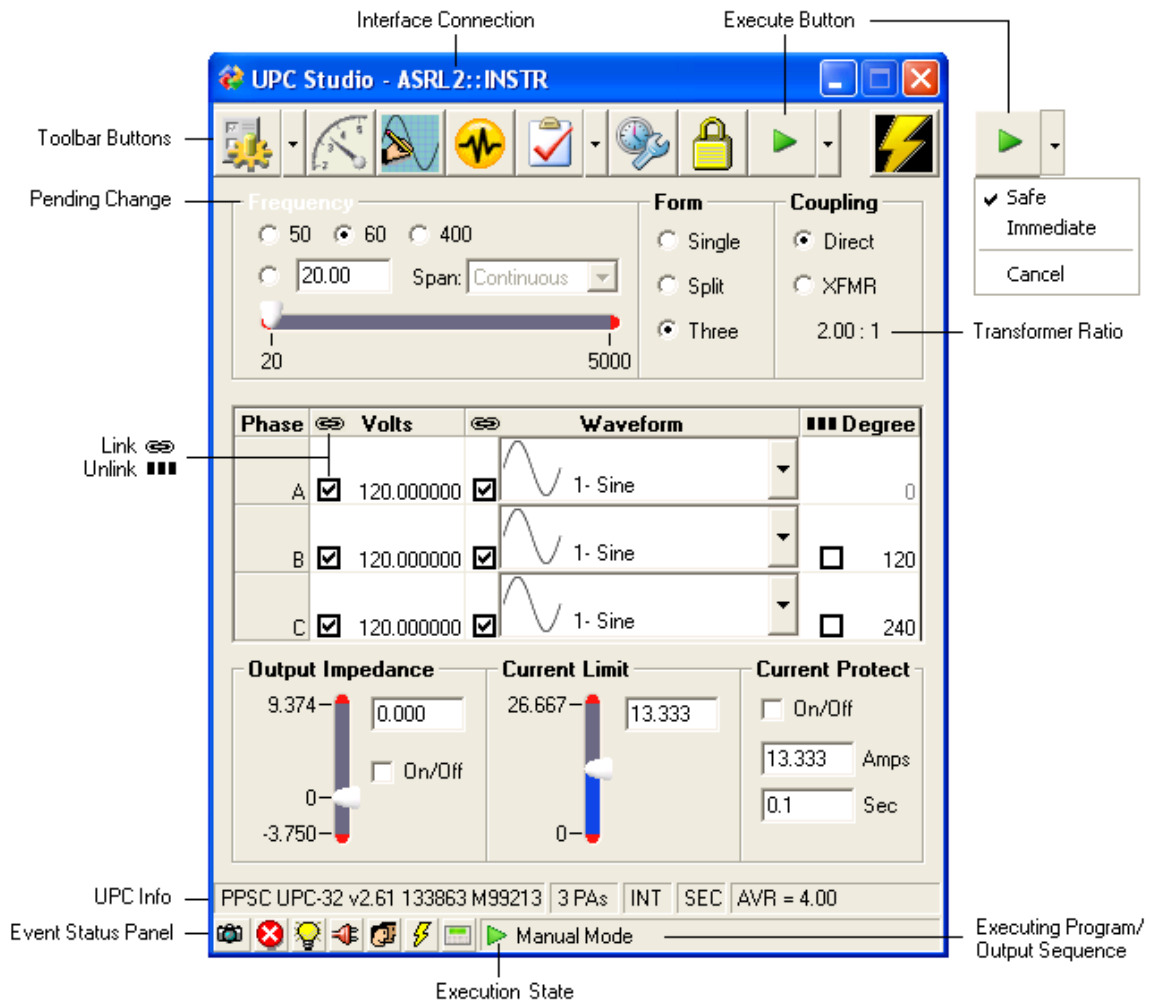

## 4.2.2 Toolbar Buttons



The UPC Control (Ref. Para. 5) button includes a drop down menu that allows you to view the various panels in the UPC Control window. This menu is intended for troubleshooting purposes. Using the UPC Control window is not recommended because it bypasses the safeguards in UPC Studio. Choosing "Refresh" causes the values shown in UPC Studio to be re-read from your UPC. This normally isn't necessary unless you change values using the UPC front panel (not recommended when UPC Studio is connected to your UPC), causing UPC Studio to get out of sync.



This button activates the UPC Meter window (Ref. Para. 11).



This button opens the Waveform Editor (Ref. Para. 4.3).



This button opens the Output Sequence Browser (Ref. Para. 4.4).

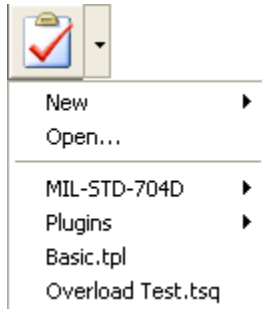

The Test Manager button allows you to open test manager (\*.tsq or \*.tpl) files. This button includes a drop down menu that lets you create a new test plan or test sequence. The drop down menu also shows the file/directory structure of the Test Manager folder (typically "C:\Pacific Power Source\UPC Manager\Test Manager"). Selecting one of these items opens that file.



Toggling this button turns CSC (Continuous Self Calibration) ON or OFF. When the button is depressed, CSC is ON.



This button set the UPC local lockout mode. When local lockout is active (Lock icon), the UPC front panel is disabled. When local mode is active (Key icon), you can access the UPC keyboard and view the LCD display. **Note:** You should not change items using the UPC front panel because it will cause UPC Studio to get out of sync.



When "Safe" mode is selected (default), pressing this button sends any pending changes you made in the UPC Studio window (or Adjust window) to your UPC. Pending changes are indicated by flashing white text. You can discard pending changes by choosing "Cancel". If you want changes to take effect immediately, choose "Immediate" then enter "DANGER" when prompted for a password.



This button toggles the output contactor of your power source. A black background means the output is disabled (contactor open) and a red background means the output is enabled (contactor closed).

### 4.2.3 Link/Unlink

The **Link/Unlink** icon is available for columns in the table. This allows you to set the values for all phases independently or as a group. To change **Link/Unlink**, click in the column header. You can also selectively link items using the row checkboxes.

### 4.2.4 UPC Info

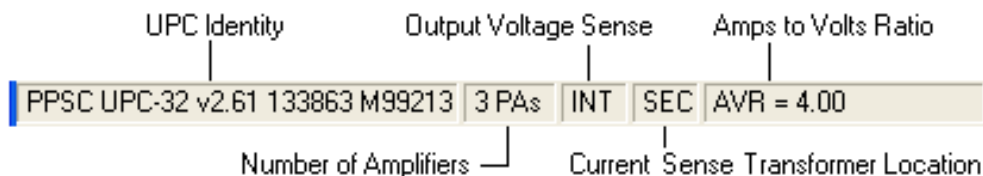

Most of the items in the **Info** panel relate to factory installed options. These items show the firmware and hardware configuration of your UPC and power source. **UPC Identity** is based on the "\*\*IDN?" query and shows the firmware options installed in your UPC. **Output Voltage Sense** can be either internal (INT) or external (EXT) and can be reconfigured using the UPC Control window Setup panel. The **Current Sense Transformer Location** can be either primary (PRI) or secondary (SEC) and the current sense transformer ratio is also shown.

### 4.2.5 Event Status Panel

Refer to the Event Status Panel section 4.8 for more information on these items.

## 4.3 Waveform Editor



The Waveform Editor is opened when you click the icon in the toolbar of the main UPC Studio window or Output Sequence window. The waveform editor allows you to view all waveforms stored in your UPC or in a particular output sequence. Waveforms stored in your UPC are the ones currently being used to generate the output voltages of your power source. Waveforms belonging to an output sequence are stored in the output sequence file. When that output sequence is executed, the necessary waveforms are downloaded into your UPC. The title bar of the waveform editor window shows the location of the waveforms contained in the window. In the example below, these waveforms are the ones currently loaded into your UPC.

The waveform editor allows you to import, export, edit, print, or create arbitrary waveforms. UPC Waveforms are based on 1024 steps which represent 360 degrees (one complete cycle). The full scale amplitude range is +/-100%. Your UPC automatically scales these waveforms to achieve the Vrms value you enter in the main UPC Studio window or output sequence. Note that waveform 1 (Sine) is reserved meaning the contents cannot be changed but you can edit the **Title** and **Comments**.

The screenshot displays the 'UPC Waveforms - ASRL2::INSTR' window. It features a 'Waveforms Table' with the following data:

Waveform	Title	CRC	Max Vrms	DC Offset %	Comments
1	Sine	-20844	150	0.0000	Factory Sine
2	Triangle	-21951	150	0.0000	Factory Triangle
3	Square	13059	150	0.0000	Factory Square
4	Pulse	2995	70.08	0.0177	Factory Pulse
5	Dropout	58	150	-3.9793	

Below the table is a toolbar with buttons for Import, Export, Revert, Save, Draw, Pan, Zoom, Select, and Mirror. An 'Amplitude Table' is also visible, showing a list of indices, degrees, and percentages. To the right, a graph titled 'Waveform #5 - Dropout' plots Amplitude % (from -100 to 100) against Degrees (from 0 to 360). The graph shows a sine wave with a sharp dip (dropout) at approximately 120 degrees. A vertical green bar highlights the dropout region. At the bottom, an 'Event Status Panel' includes icons for various functions and a 'Manual Mode' indicator.





### 4.3.1 Waveforms Table

This table shows all waveforms stored in the UPC or output sequence file. You can click in the **Title** and **Comments** cells to enter your own text. The **CRC** column shows a unique number based on the actual waveform data. This allows the waveform editor to associate the waveform name and comments to a particular waveform stored in the **waveforms reference database**. This database file is stored in the same directory as the UPC Manager application and is automatically updated and maintained by UPC Studio. The **Max Vrms** column shows the maximum allowable output voltage that can be achieved for that waveform for your power source using the coupling and transformer ratio selected in the main UPC Studio window. The **DC Offset %** column shows the DC component of the waveform. DC offsets occur when the RMS value of the first and second half cycle of the waveform are not equal and opposite. This typically

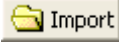

happens when simulating a half cycle dropout or spike. A warning icon  is displayed if the absolute value of the DC offset is greater than 1%. You can set this value to 0 by using the **Zero DC Offset** function in the Waveform Graph Context menu.

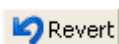
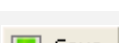
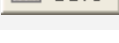
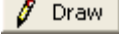
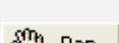
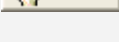
## 4.3.2 Toolbar buttons

	Refer to the Importing, Exporting and Printing section below for more info.
	Refer to the Importing, Exporting and Printing section below for more info.
	This button is only enabled after you begin editing. Clicking this button will revert the waveform to the values last saved. This effectively undoes all your changes.
	This button is only enabled after you begin editing. Clicking this button will save the waveform to your UPC or output sequence.
	When this button is depressed, you can use the mouse to draw arbitrary values in the waveform graph.
	When this button is depressed, you can pan (reposition) the waveform when you click and drag the mouse in the graph. You can also use "Default" in the Waveform Graph Context menu to re-center the graph.
	When this button is depressed, the graph zooms-in (magnifies) when you click the mouse in the graph. If you press and hold the shift key, the graph zooms-out (reduces) when you click the mouse in the graph. You can also use "Default" in the Waveform Graph Context menu to reset the zoom to normal (100%).
	When this button is depressed, you can click and drag the mouse in the graph to make a selection. Some functions in the Waveform Graph Context Menu require that you first make a selection. The selection is also shown in the amplitude table.
	This button toggles the mirror state. When the mirror button is depressed, any changes you make to the waveform are automatically "mirrored" 180 degrees. This helps to maintain 0% DC offset or to create symmetrical waveforms.

## 4.3.3 Amplitude Table

The amplitude table shows the index, degrees and amplitude (in percent) for all 1024 waveform steps. You can click cells in the **Percent** column to change a value. Editing a cell in a selection range affects all selected rows. Right-clicking in the amplitude table displays a shortened version of the Waveform Graph Context Menu.

#### 4.3.4 Selection

Clicking and dragging the mouse in the amplitude table selects a range of rows. You can also "shift-click" to create a selection range. The selection also appears in the waveform graph. Clicking in the header row of the amplitude table removes the selection. If the **Select** button is depressed in the Toolbar, you can also click and drag the mouse in the graph to select a portion of the waveform. The corresponding rows in the amplitude table are also selected.

#### 4.3.5 Waveform Graph Context Menu

This menu appears when you *right-click* the mouse in the *graph*. A shortened version of this menu also appears when you right-click the amplitude table. Some items in this menu apply to the selection in the amplitude table or graph. Refer to the previous topic for information on making a selection.

Default	
Show Cursor	
Select All	Ctrl+A
Copy	Ctrl+C
Paste	Ctrl+V
Undo	Ctrl+Z
Scale...	
Set...	
Offset...	
Noise...	
Clipped Sine...	
Ring...	
Flip Vertical	
Flip Horizontal	
Zero DC Offset	
Draw	
Pan	
Zoom	
✓ Select	
Mirror	

Item	Description
Default	Centers the graph view and sets the zoom level to normal (100%).
Show Cursor	Tracks the mouse movement in the graph with a vertical cursor. Cursor annotation text is also displayed showing the waveform index, degrees and amplitude.
Select all	Selects all 1024 steps (360 degrees) of the waveform.
Copy	Copies the selection to the clipboard.
Paste	Pastes the clipboard to the waveform at the start of the selection.
Undo	Undoes the last change. This menu item then changes to Redo, allowing you to restore the last change.
Scale	Multiplies the amplitude of the selection by the scale factor you enter.
Set	Sets the amplitude of the selection to the value you enter.
Offset	Shifts the amplitude of the selection by the value you enter.
Noise	Adds a random number (+/-) to the amplitude of the selection. The amplitude of the noise is based on the value you enter.
Clipped	Creates a clipped sine wave based on the THD (Total Harmonic Distortion) number you enter.
Ring	See the Ring Window for more information.
Flip Vertical	Multiplies the amplitude of the selection by -1 (inverts).
Flip Horizontal	Reverses the index (degrees) of the selection. This swaps the left to right orientation of the selection.
Zero DC Offset	Removes the DC component of the entire waveform.
Draw	Sets the mouse action in the graph to allow you to draw arbitrary values.
Pan	Sets the mouse action in the graph to allow you to move the waveform view horizontally or vertically.
Zoom	Sets the mouse action in the graph to zoom-in (magnify) the waveform. Holding the Shift key allows you to zoom-out (reduce) the waveform.
Select	Sets the mouse action in the graph to select a portion of the waveform. The selection also appears in the amplitude table.

Mirror Toggles the Mirror state. When this item is checked, any changes you make to the waveform are automatically "mirrored" 180 degrees. This helps maintain 0% DC offset or to create symmetrical waveforms.

## 4.3.6 Importing, Exporting and Printing Waveforms

Right-clicking a row in the Waveforms Table displays the Waveform Table Context menu.

Import...  
Export...  
Print...

Selecting Import or Export displays a file dialog. Shown below is the Import file dialog.

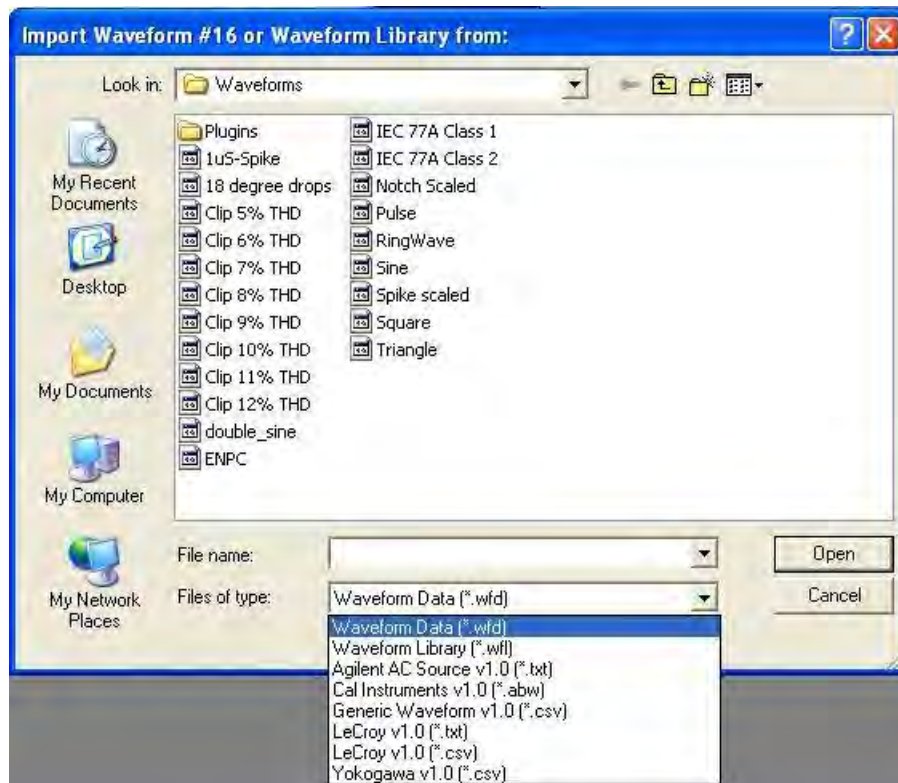

The file type menu at the bottom allows you to import or export a single waveform (Waveform Data), all waveforms (Waveform Library) or custom waveform. Custom waveform file formats are supported using waveform plug-ins. These DLL files are stored in the Plug-ins folder (typically "C:\Pacific Power Source\UPC Manager\Waveforms\Plug-ins"). Contact Pacific Power if you have a custom waveform file format you want to import or export using the Waveform Editor.

Importing waveforms from an Oscilloscope file will require you to select the portion of the captured data you wish to use for your waveform. If you have a multiple channel Oscilloscope you may have more than one column of data. The following screen is the 'Generic Waveform Import' selection wizard:

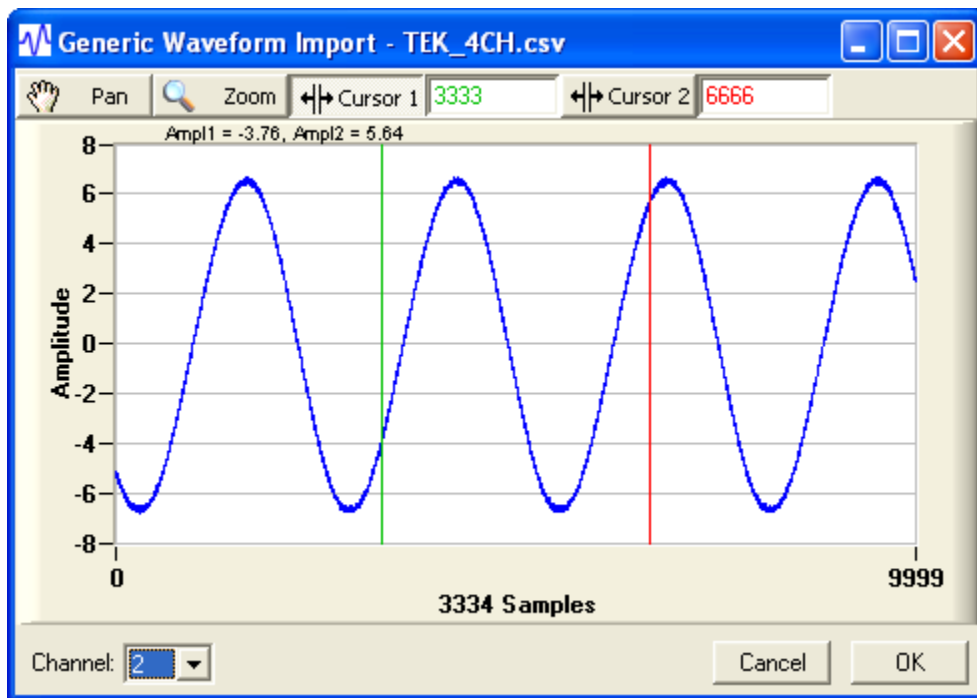

Using the Pan and Zoom functions you can locate the portion of the waveform you wish to import. Selecting "Cursor 1" will let you position the first cursor at the beginning of the waveform. Selecting "Cursor 2" will let you position the second cursor at the end of the waveform. Pressing OK will import the selected portion of the waveform.

### 4.3.7 Harmonic Synthesis

Clicking the **Synthesis Tab** allows you to create waveforms based on harmonic amplitude and phase as shown below.

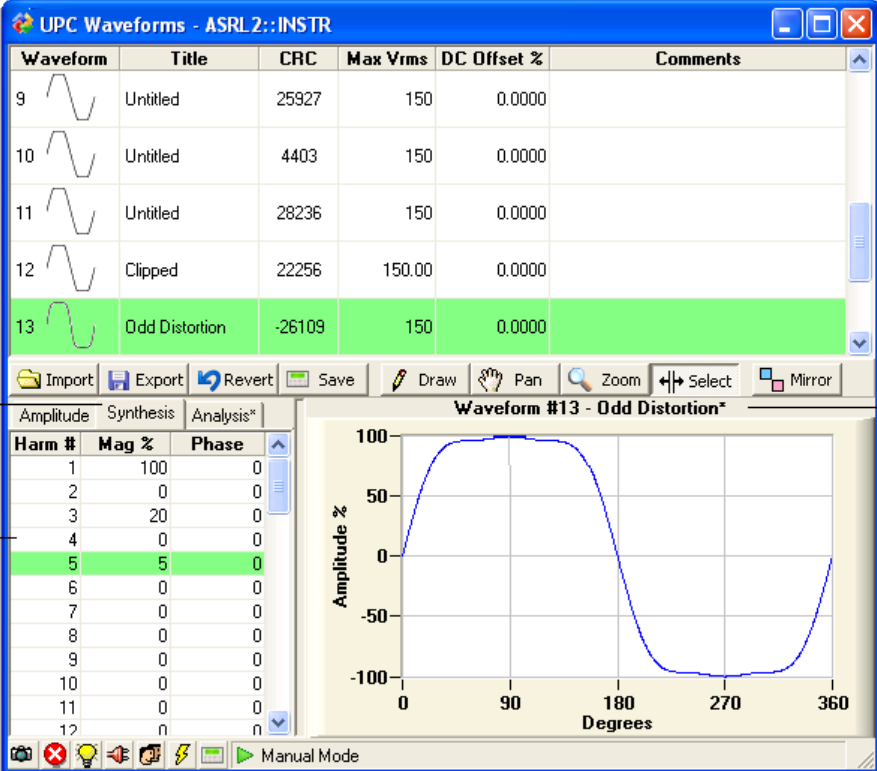

The screenshot shows the 'UPC Waveforms - ASRL 2::INSTR' window. At the top is a table of waveforms:

Waveform	Title	CRC	Max Vrms	DC Offset %	Comments
9	Untitled	25927	150	0.0000	
10	Untitled	4403	150	0.0000	
11	Untitled	28236	150	0.0000	
12	Clipped	22256	150.00	0.0000	
13	Odd Distortion	-26109	150	0.0000	

Below this table is a toolbar with buttons for Import, Export, Revert, Save, Draw, Pan, Zoom, Select, and Mirror. The 'Synthesis Tab' is selected, showing a 'Harmonics Table' and a waveform plot.

The 'Harmonics Table' is as follows:

Harm #	Mag %	Phase
1	100	0
2	0	0
3	20	0
4	0	0
5	5	0
6	0	0
7	0	0
8	0	0
9	0	0
10	0	0
11	0	0
12	n	n

The waveform plot, titled 'Waveform #13 - Odd Distortion\*', shows Amplitude % on the y-axis (ranging from -100 to 100) and Degrees on the x-axis (ranging from 0 to 360). The plot shows a distorted sine wave with a peak at 90 degrees and a trough at 270 degrees.

Annotations in the image point to the 'Synthesis Tab' and the 'Harmonics Table' on the left, and the 'Waveform number and Title' on the right.

Right-clicking the table will display the Harmonics Synthesis Menu.

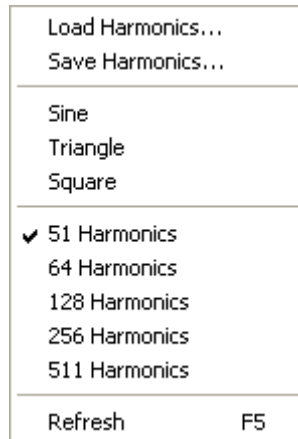

This menu allows you to load or save the harmonics table to a file. "Loading" is convenient when you want to use the harmonic analysis values (see below) of an existing waveform as the starting values. Selecting "Sine", "Triangle" or "Square" fills in the table with a harmonics series that creates that waveform. You can also specify the number of harmonics used to create the waveform. You can click in the table cells to enter values for **Mag %** and **Phase**. The **Synthesis** tab will include an "\*" if the table values do not represent the current waveform. Press **F5** or choose **Refresh** from the menu to update the waveforms.

#### 4.3.8 Harmonic Analysis

Clicking the **Analysis Tab** allows you to view the distortion and harmonic content of the selected waveform as shown below.

The screenshot shows the 'UPC Waveforms - ASRL2::INSTR' window. At the top is a table of waveforms:

Waveform	Title	CRC	Max Vrms	DC Offset %	Comments
9	Untitled	25927	150	0.0000	
10	Untitled	4403	150	0.0000	
11	Untitled	28236	150	0.0000	
12	Clipped	22256	150.00	0.0000	
13	Odd Distortion	-26109	150	0.0000	

Below the table is a toolbar with buttons for Import, Export, Revert, Save, Draw, Pan, Zoom, Select, and Mirror. The 'Analysis Tab' is selected, showing a sub-table for 'Waveform #13 - Odd Distortion\*':

Harm #	Mag %	Phase
THD	20.620	
OHD	20.620	
EHD	0.000	
1	100.000	0.000
2	0.000	90.000
3	20.004	0.000
4	0.000	90.000
5	5.001	0.001
6	0.000	90.000
7	0.000	71.213
8	0.000	90.000
9	n nn?	1.829

To the right of the table is a graph titled 'Waveform #13 - Odd Distortion\*' showing Amplitude % vs Degrees. The graph shows a sine wave with a peak at 90 degrees and a trough at 270 degrees. The y-axis ranges from -100 to 100, and the x-axis ranges from 0 to 360.

Annotations in the image point to the 'Waveform number and Title' (pointing to the table header) and the 'Harmonics Table' (pointing to the sub-table).

This harmonics analysis table cannot be edited and is automatically updated as waveforms are selected or changed. Right-clicking the table will display the Harmonics Analysis Menu.

Load Harmonics...	
Save Harmonics...	
Refresh	F5

This menu allows you to load or save the harmonics table to a file. "Saving" is convenient when you want to use the harmonic analysis values of an existing waveform as the starting values for harmonic synthesis. The **Analysis** tab will include an "\*" if the table values do not represent the current waveform. Press **F5** or choose **Refresh** from the menu to update the table.



### 4.3.9 Ring Edit Window

The Ring Edit window is accessed by selecting "Ring" in the Waveform Graph Context Menu in the Waveform Editor. The Ring Edit window allows you to superimpose a ring onto the waveform you are editing (base waveform) in the waveform editor. Changes in the Ring Edit window are immediately shown in the graph in the waveform editor.

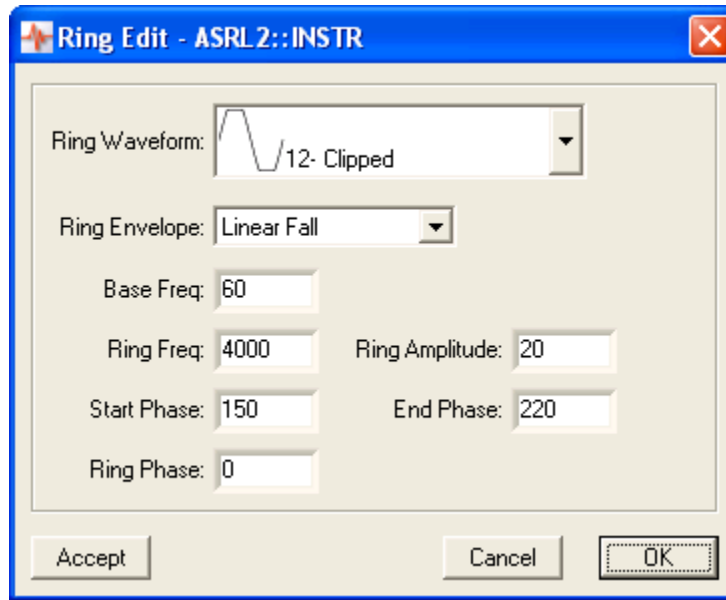

Item	Description
Ring Waveform	This is the waveform used for the ring. The default waveform is a sine wave but you can use any waveform shown in the drop down list.
Ring Envelope	Defines the amplitude envelope of the ring.
Base Frequency	This is an arbitrary reference frequency representing the base waveform.
Ring Frequency	This is an arbitrary reference frequency of the ring and is relative to the base frequency.

Ring Amplitude	This is the amplitude of the ring in percent.
Start Phase	This is the phase angle (degrees) of the base waveform where the ring will start.
End Phase	This is the phase angle (degrees) of the base waveform where the ring will end.
Ring Phase	This is the starting phase angle (degrees) of the ring waveform.
Accept	Commits the ring to the base waveform and allows you to create another ring.
OK	Commits the ring to the base waveform and closes the window.
Cancel	Undoes ring editing and closes the window.

The diagram below shows how the Ring Edit values relate to the base waveform.

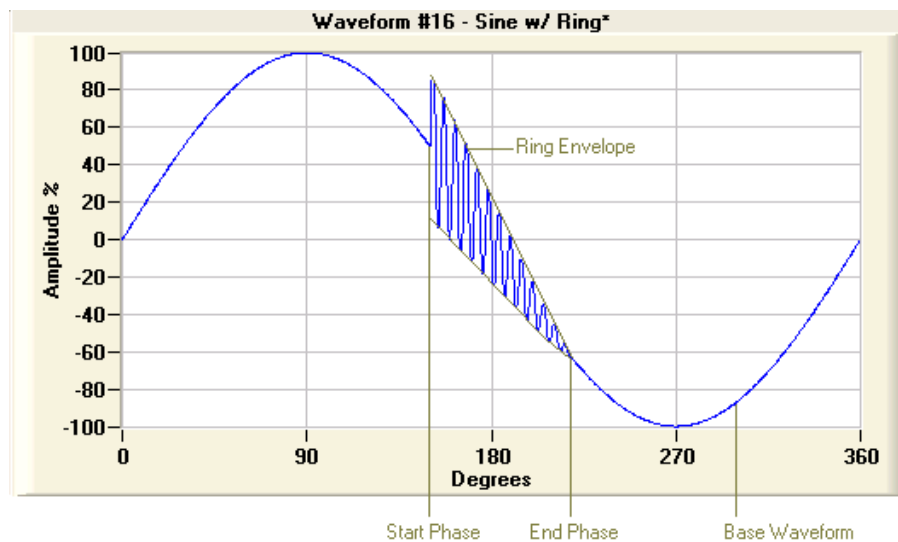

## 4.3.10 Event Status Panel

Refer to the **Event Status Panel** section 4.8 for more information on these items.

## 4.4 Output Sequence Browser

This window is accessed by pressing the Output Sequence Browser button in the main UPC Studio window.

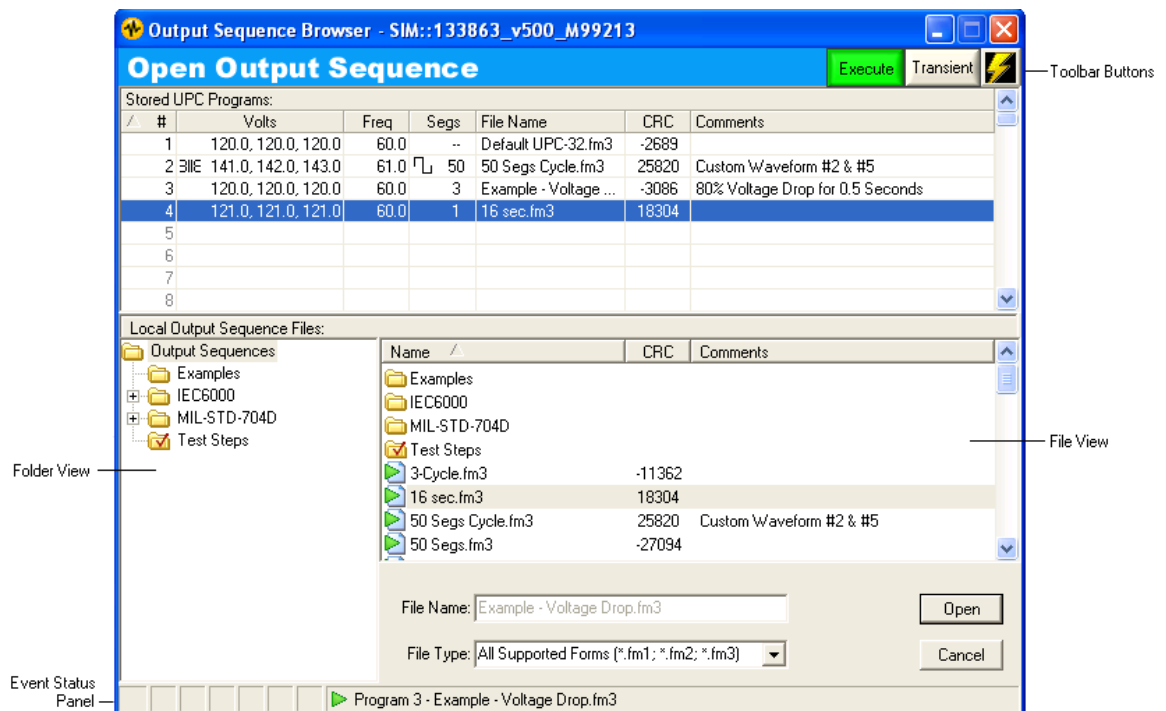

The top panel shows the programs stored in your UPC. The bottom panel shows the output sequence files locally stored on your PC. The root folder for the output sequence files is located in the same directory as the UPC Manager application (typically “C:\Pacific Power Source\Upc Manager\Output Sequences”). Only output sequences stored at or below this directory level are available to the browser.

Output sequence files provide a graphical interface that allows you to view and edit UPC programs. When an output sequence is saved to your UPC,

the file itself is not transferred. Instead, the file contents are translated into native UPC steady state and transient segment parameters. The Output Sequence Browser uses CRC information to keep track of which output sequence files are stored in your UPC. In the above example, the browser was able to associate Programs 1, 3 and 4 to the output sequence files listed. But a local output sequence file could not be located for Program 2 (shown in italics). You can open an output sequence or stored UPC program by selecting it in either the **Stored UPC Programs** table or the **File View** and then click the **Open** button. Refer to the Output Sequence window section for more information. To copy an output sequence file to your UPC, simply click and drag the file to the desired program.

#### 4.4.1 Stored UPC Programs Table

This table shows all programs in your UPC. The table shows a brief summary of the program's voltage, frequency and transient. The transformer icon indicates the program uses transformer coupling and the cycle icon indicates the transient is cycle based. If the program does not contain a transient, the **Segs** entry for that program is blank. Italic text means a local output sequence file on your PC could not be found. When you open a program, the Output Sequence window is displayed using the appropriate output sequence file. If a file doesn't exist, a new one is created with the name "Untitled #n" where "n" is the program number. The Output Sequence window allows you to specify a different name (when saving) and enter any comments that will appear in the browser.

Right-clicking a row in the table allows you to access the functions in the context menu shown below.

New	Ctrl+N
Cut	Ctrl+X
Copy	Ctrl+C
Paste	Ctrl+V
Delete	Del
Refresh	F5

Using any of these menu items immediately affects the programs stored in your UPC. **Refresh** causes your UPC to be queried for stored programs and checks for any associated output sequence files.

## 4.4.2 Toolbar Buttons

The toolbar buttons are available when you select a row that contains a program. These buttons are described below:



This button allows you to execute the steady state portion of the selected program. It turns green while the selected program is executing. Un-pressing this button switches the UPC to Manual Mode.



This button allows you to execute the transient portion of the selected program. It turns yellow while the transient of the selected program is running. This button also shows if a Ramp is executing Un-pressing this button stops the transient or Ramp and resumes steady state operation. Refer to the Adjust window for more information about Ramps.



This button indicates the output contactor state of your power source. You can click this button to toggle output state. A black background means the output is disabled (contactor open) and a red background means the output is enabled (contactor closed).

**Note:** Pressing the **Execute** button also turns on the output contactor.

### 4.4.3 Folder and File Views

The Folder and File views provide a Windows Explorer type interface. You can create folders, rename files, or move files by clicking and dragging. Right-clicking in either section displays the context menu shown below.

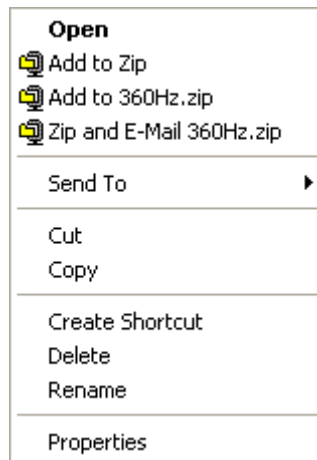

The file extension used for output sequences is based on the output Form. The **File Type** drop down menu shows the output Forms supported by your power source. You can use this menu to filter out which files (Forms) are shown.

### 4.4.4 Event Status Panel

Refer to the **Event Status Panel** section 4.8 for more information on these items. Note that the executing program number and output sequence file name in the event status panel match the program selected in the Stored UPC Programs table.

## 4.5 Output Sequence Window

When you open an output sequence or UPC program from the Output Sequence Browser, the Output Sequence windows appears as shown below.

The screenshot displays the 'Output Sequence - ASRL2::INSTR - Program #3 - 150v Stress Test' window. It features several key components:

- Toolbar Buttons:** Revert, Save As..., Waveforms, Details, and an Output Enable button (lightning bolt icon).
- Steady State:**
  - Form: 3, Freq: 15.000000
  - Coupling: DIRECT
  - Curr Limit: 50.000000 Amps
  - IProt: 50.000000 Amps, 0.1 Sec
- Phase/Volts/Waveform Table:**

Phase	Volts	Waveform	Degrees
A	120.000000	1- Sine	0
B	120.000000	1- Sine	120
C	120.000000	1- Sine	240
- Transient Segments Table:**

Seg	Freq	Volts (A)	Volts (B)	Volts (C)	Waveform (A)	Waveform (B)	Waveform (C)	Duration
1	60.000000	30.000000 Vrms	120.000000 Vrms	120.000000 %	1	1	1	0.500000 Sec
2	60.000000	50.000000 Vrms	120.000000 Vrms	120.000000 Vrms	1	1	1	60.000000 Cyc
CR	60.000000	50.000000 Vrms	120.000000 Vrms	120.000000 Vrms	1	1	1	0.250020 Cyc
- Transient Graph:** A graph showing Vrms (0-200) and Frequency (0-100) over time. A yellow shaded region highlights the transient event from 0.5 to 1.5 seconds. The graph shows three voltage waveforms (A, B, C) and a frequency waveform.
- Transient Controls:**
  - Buttons: Elapsed, EXECUTE, TRANSIENT
  - Options: Once, Forever, Number of Events (8), Single Cyc, Auto RMS
  - Transient Event Progress: 1.5042 Sec/Event, 8 Events
- Graph Checkboxes:** Frequency, Volt A, Volt B, Volt C
- Event Status Panel:** Manual Mode, CRC, Comments: Rise to 150 Volts & Hold for 60 Cycles, Total Transient Time: 12.0333 Sec

## 4.5.1 Toolbar Buttons

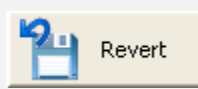

Revert

This button is only available after you make a change in the window. Clicking this button undoes all your changes and restores the output sequence to its original state.



Save As...

This allows you to save this output sequence to another file or UPC program. Refer to the Saving Output Sequences section for more information.

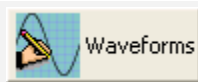

Waveforms

This button opens the Waveform Editor for the waveforms contained in this output sequence.



Details

This button allows you to view a simulation of the output sequence (See Section 10).



This button toggles the output contactor of your power source. A black background means the output is disabled (contactor open) and a red background means the output is enabled (contactor closed). This button is automatically activated when you press the **Execute** or **Transient** button.

## 4.5.2 Execute Button and Elapsed Time Indicator

Your power source is updated with the steady state values when you press the Execute button. Pressing the Execute button also turns the Output Enable On. The Execute button also indicates when this program is Executing. The Elapsed time indicator shows how long the program has been running. Un-pressing the Execute button switches the UPC to Manual Mode.



## 4.5.3 Transient Button and Elapsed Time Indicator

The Transient button executes the steady state values, turns the Output Enable On, and then starts executing the transient event(s). The Transient



button also indicates when the transient is running. Un-pressing the Transient button stops the transient and resumes steady state operation. The Elapsed time indicator and Transient Event Progress bars show how long the transient has been running. If a Ramp is programmed (see Adjust window), the Transient button will indicate when the Ramp is running.

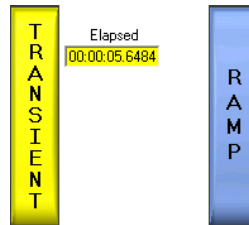

## 4.5.4 Transient Segments

The Transient Segment table defines a transient event. When the Transient button is pressed, the event defined by these segments is repeated by the number of events you specified by the **Number of Events** items. Right-clicking a row in the **Seg** column of this table displays the Segment Context menu shown below.

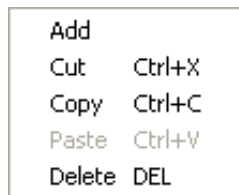

These menu items act on the location of the mouse when you right-clicked or the selected row(s). The table below describes these items.

Item	Description
Add	Adds a transient segment row immediately past the current selection.
Cut	Cuts the selected row(s) and copies them to the clipboard.
Copy	Copies the selected row(s) to the clipboard.
Paste	Pastes the clipboard immediately past the current selection.
Delete	Deletes the selection.

You can select one or more rows by clicking (or dragging) in the **Seg** column for that row. The selection is highlighted in yellow. The graph also shows the selection.

For a time based transient (**Cycle Based Transient Checkbox** is not checked), the frequency and voltage values entered in a row are the ending values. Your UPC smoothly transitions each segment to the ending values starting with the values of the previous segment (or steady state). You can specify the units of the Volts or Duration table cells. The Volts units can be toggled between Vrms and percent steady state by clicking the **Vrms** or **%** text. Percent steady state means the segment voltage for that phase is a percentage of the corresponding steady state voltage. For the Duration table cells, you can toggle the Duration units between seconds and cycles by clicking on the **Sec** or **Cyc** text.

For a cycle based transient (**Cycle Based Transient Checkbox** is checked), the segment values for frequency and voltage immediately take affect without any transition from the prior segment. Also, the duration table cells are always 1 cycle and cannot be edited.

#### 4.5.5 Cycle Reset

The Cycle Reset segment is automatically created for time based transients. Transient events always begin with the phase A zero crossing. The duration of the Cycle Reset segment is calculated from when the last user segment ends until the next phase A positive zero crossing. You cannot edit the values of the Cycle Reset segment but you can select it to view in the graph.

#### 4.5.6 Out of Range Values

Values with **red** text are out of range. This means the value is outside the allowable range for that item. This can occur, for example, if the output sequence (file) was created on a different power source (that supported that value) or the value exceeds the limits currently programmed in your UPC. To Display the Adjust window, right-click on the value. The Adjust window shows the valid range of values and allows you to view or change the limits.

### 4.5.7 Transient Graph

The Transient Graph shows a graphical representation of the transient segments. Clicking in the graph highlights that segment. The graph shows the values as they transition from one segment to the next starting with the steady state values. If you specified more than one transient event, only the first event is shown. The **Total Transient Time** calculation displayed at the bottom right of the graph includes all events. A vertical cursor shows the elapsed time, voltage and frequency. You can selectively show a particular plot by clicking the Graph Checkboxes. The **Details** button allows you to see an exact simulation of the output sequence.

When you right click in the transient graph, the graph context menu appears.

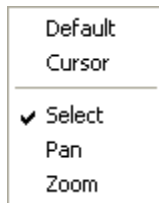

The items in this menu are described below.

Item	Description
Default	Sets the time axis to show the entire transient event. This undoes any Pan or Zoom.
Cursor	Displays a vertical cursor and annotation values that show the voltages and frequency at the cursor position.
Select	Clicking in the graph selects the associated segment.
Pan	Clicking and dragging the mouse in the graph shifts the graph left or right. This also allows you to view the steady state values before and after the transient event.
Zoom	Clicking the mouse in the graph zooms-in (expands) the graph time. Shift-clicking the mouse zooms-out (contracts) the graph time.

#### **4.5.8 Link/Unlink**

Clicking the Link/Unlink icon toggles the Link/Unlink state of that table column. When a column is linked, changing one item in that column sets all other items to the same value.

#### **4.5.9 Event Status Panel**

Refer to the **Event Status Panel** section 4.8 for more information on these items.

#### **4.5.10 CRC**

This is a unique number calculated from the values in the output sequence. The Output Sequence Browser uses this number to associate output sequence files to stored UPC programs. NOTE: The comments section of the Output Sequence is not used to generate the CRC number, but is displayed in the Open Output Sequence window.

#### **4.5.11 Comments**

Text entered here appears in the Output Sequence Browser window.

#### **4.5.12 Cycle Based Transient Checkbox**

Your UPC supports two kinds of transients - time based and cycle based. Each segment of a time based transient can be any duration of time between 200usec and 300 seconds. The frequency and voltage smoothly change from one segment to the next. Cycle based transient segments are exactly one cycle in duration based on the segment frequency. The frequency and voltage of cycle based transients instantaneously changes from one segment to the next.

#### **4.5.13 Transient Waveform Auto RMS Checkbox**

When this checkbox is checked (default), the RMS voltage of each transient segment/phase is based on the waveform specified for that phase. When this checkbox is not checked, the RMS voltage of each transient segment/phase is based on the steady state waveform

RMS factor. Unchecking this checkbox is handy when simulating a voltage spike or drop out. Refer to the UPC Operation Manual for more information.

#### 4.5.14 Number of Events

These items determine how many times the transient segments are repeated when you press the Transient button.

#### 4.5.15 Transient Event Progress

These bars show the progress of the transient based on the transient time of each event and the total number of events.



### 4.6 Saving Output Sequences

Output sequences are stored in local files on your PC and optionally, in one or more stored UPC programs. You have several options when saving output sequences. When you press the **Save As** button, the **Save Window** appears as shown below.

If you press the **Execute** or **Transient** button in the Output Sequence window and your changes are not currently saved to a UPC program and file, the **Execute and Save Window** appears as shown below.

These windows are actually the Output Sequence Browser reconfigured with a series of checkboxes in the **Stored UPC Programs** table. These checkboxes allow you to select the UPC program to store. In the file browser section, you can select an existing file to overwrite or enter a new file name. The **File Type** is automatically selected for you. It's based on the output Form specified in the Output Sequence window. If the output sequence is currently stored in more than one UPC program, these program rows are grouped at the top of the table.

## 4.6.1 Save Window

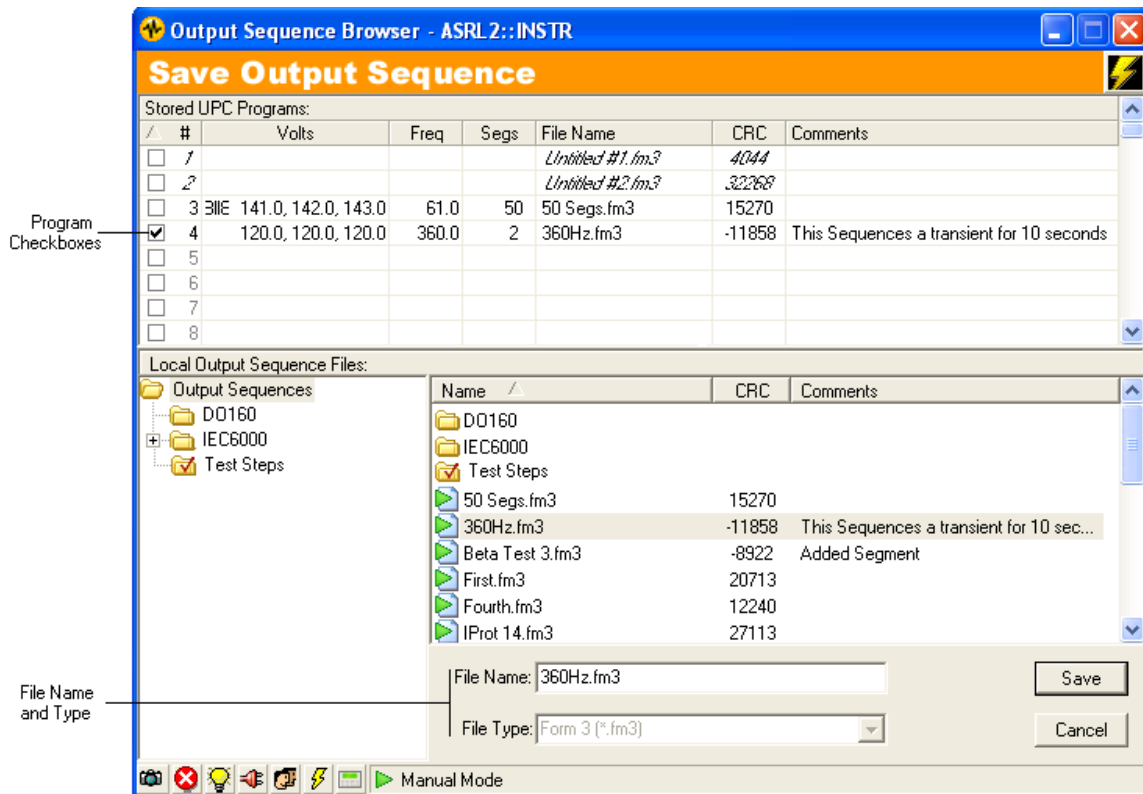

## 4.6.2 Save and Execute Window

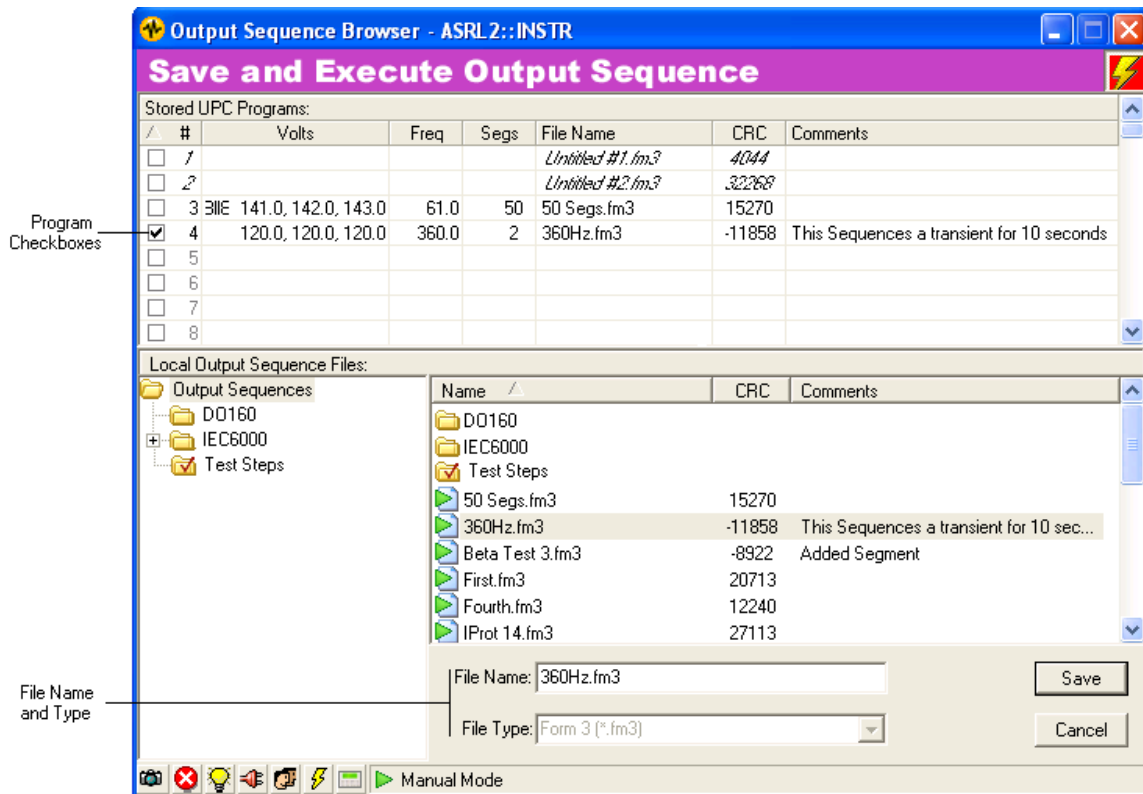

## 4.7 Adjust Window

This window can be accessed from the main UPC Studio window or Output Sequence window. It appears when you right-click the **Frequency** or the **Volts** or **Degrees** table cells. The examples below show the Adjust window after right-clicking one of the **Volts** table cells in UPC Studio and the steady state **Frequency** in the Output Sequence window.

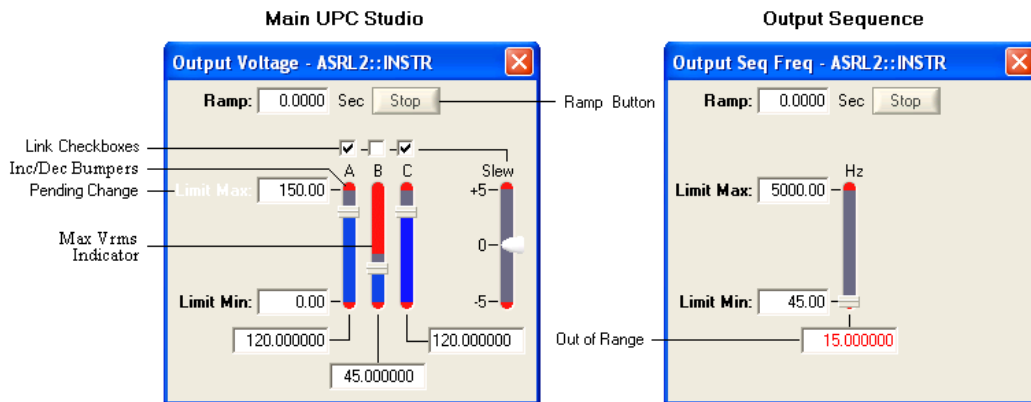

Use the sliders or the number boxes at the bottom to change values. Changing a value with the **Link** checkbox "checked" means all other "checked" phases will be affected.

### 4.7.1 Ramp

This number box allows you to control the transition time (in seconds) used when changing values. A ramp time of 0 means the output immediately changes to the new value. Programming a Ramp time provides a smooth transition to the new value. When the Ramp is executing, the button changes (shown below) indicating the Ramp is in progress and it also allows you cancel the Ramp.



**Note:** Voltage or Frequency changes can be ramped but not Phase (degrees) changes.



### 4.7.2 Pending Change

Whenever a Min or Max Limit change is pending, the bold text associated with that item flashes white. The way changes are handled in the Adjust window tracks the Execute mode presently configured in the main UPC Studio window. Refer to the Execute button section for more information.

**Note:** Pending changes only apply if the Adjust window was accessed from the main UPC Studio window.

### 4.7.3 Max Vrms Indicator

This applies only when using the Adjust window to change the voltage. The red indicator shows the maximum voltage allowed for that phase based on the Waveform, Form and Coupling presently indicated in the main UPC Studio window or Output Sequence window. Based on these values, there may be cases where your power source may not be capable of setting the output voltage for that phase to the **Limit Max** value. You can hover the mouse over the slider to see the max Vrms value allowed. Refer to the Waveform Editor for more information about **Vrms max**.

### 4.7.4 Out of Range

Values with **red** text are out of range. This means the value is outside the allowable range for that item. The Voltage range is determined by the Form, Coupling, Waveform (of that phase) and the Limit Min/Max value. The Frequency range is determined by the Limit Min/Max value. The Phase (degree) range is 0 to 359 degrees.

**Note:** You will not be able to Execute an output sequence that contains an out of range value.

### 4.7.5 Slew

This is a "spring loaded" control that allows you to slew the values up or down. The further from the center (0), the greater the change and the scale is logarithmic. Only phases that are checked will be slewed. Slew changes the values in real time when the Execute mode is "Immediate" so it behaves similar to the UPC front panel slew controls.

**Note:** The slew control is not available for Output Sequences.

#### 4.7.6 Inc/Dec Bumpers

Clicking at either end of the sliders changes the output by a fixed value. You can view or change this value by right-clicking on the sliders.

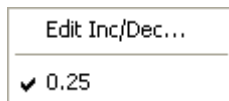

#### 4.7.7 Limit Min/Max

These items limit the allowable values you can enter for the voltage or frequency. Attempting to set your power source outside these limits will be prevented. The Info panel in the UPC Control window shows the maximum and minimum values (range) you can enter for the voltage or frequency limits.

### 4.8 Event Status Panel

The Event Status Panel shown below appears at the bottom of most UPC Studio windows.

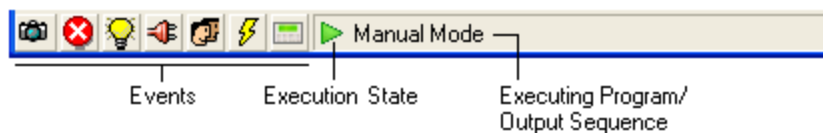

## 4.8.1 Events

Events are shown at the bottom left of the **Event Status Panel**. Except for the **Capture** icon, UPC Studio polls your UPC and automatically updates these icons. These icons indicate a particular event occurred and they remain latched until you clear them by clicking on that icon.



This icon means that Command/Query capture mode is on. Click this icon or press the **Probe** tab to view the commands and queries that have been sent to the UPC or to turn Capture mode off.



This icon means an error occurred. A message box also appears describing the error. This event is automatically cleared when you close the message box.



This icon means a power-on event has occurred with your UPC. You should normally disconnect (close) UPC Manager first before turning on/off you UPC. This event can alert you that one or more settings may have been changed and that you should refresh the affected views.



This icon means the power source has shut down due to an output overload condition.



This icon means the UPC was operating in the **Local** mode and someone pressed the Local/Remote key on the UPC front panel. This event can alert you that one or more settings may have been changed and that you should refresh the affected views.



This icon means the UPC output was turned off because the output current or voltage exceeded the programmed threshold.







This icon means the remote interface is unavailable because your UPC is not in the V/I Display mode. Press the "Clear" or "Display" buttons on your UPC keyboard to return to the V/I Display screen.



This icon means the remote interface is not responding. This can be because your UPC is turned off or the interface cable is disconnected.

## 4.8.2 Execution State

-  This icon means the steady state portion of the executing program listed is executing.
-  This icon means the transient portion of the executing program listed is executing.
-  This icon means a Ramp is currently executing. Ramps provide a smooth transition when changing an output parameter (like volts or frequency) or when executing a new program. You can view or program the Ramp time using the Adjust window.
-  This icon means no programs are executing. This is most likely caused by an illegal program parameter that would prevent it from being executed.

## 4.8.3 Executing Program

This is the program number (or Manual Mode) of the currently executing program. You can use the Output Sequence Browser to specify which program to execute. Manual Mode is automatically entered whenever an output parameter of the last executing program was changed. If the program is based on an output sequence, the output sequence file name is also shown.

## 5 Test Manager

Test Manager allows you to quickly create and run test sequences and test plans. Test sequences consist of one or more test steps designed to run a test, automate a task, or control and monitor your power source or other instruments. Test results are stored in user defined test reports. Test plans manage and simplify complex tasks by allowing you to link together a series of test sequences into a single test.

Test Manager features:

- Automate instrument compliance testing and certification. Obtain pre configured test sequences and test plans from Pacific Power Source for a variety of standard and custom applications.
- Built-in editor allow you to create and run your own custom test sequences and test plans.
- No compiling needed. Run entire tests or individual steps immediately after making changes.
- Test sequences support 8 built-in test step types including Steady State Output, Transient Trigger, UPC Control, User Prompt, User Input, Timer, VISA (generic instrument control) and UPC Metering.
- Complete UPC metering support including waveform capture and V/I/F/Power/Harmonics. Specify measurement functions and phases, value limits, out-of-limit behavior and data logging.
- Embed Scripts to create custom functions with full access to test manager objects.
- Run an entire test or control test flow using Single Step, Run-To-Next, Run Selected, Stop or Resume. Disable individual steps for troubleshooting, reconfiguring, prototyping and debugging.
- Total, elapsed and remaining time indicators for the entire test and individual steps. Monitor the progress and results of each step while the test runs.
- Custom report generation, printing and print preview. Create report templates using MS Word with page header/footer, page/paragraph/character formatting, graphics and form fields.
- Test reports fully document and record parameters and results for each test step. Built-in error handling helps isolate the root cause of failures.

### 5.1.1 Getting Started

To start UPC Manager, click **Start**, then click **Programs**, then choose **Pacific Power Source** then **UPC Manager**.

### 5.1.2 Opening and Creating Test Sequences and Test Plans

The **Test Manager** Button in the main UPC Studio window allows you to open an existing test sequence or test plan. The drop down menu also lets you create a new test sequence or test plan file and contains a list of available files located in the test manager folder (typically "C:\Pacific Power Source\UPC Manager\Test Manager") on your PC. Selecting one of these items opens that file.

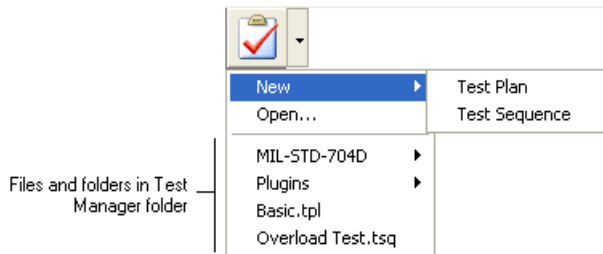

Refer to the Test Sequence or Test Plan topics for more information on editing and running these files.

### 5.1.3 Test Sequence Window

Test sequences consist of one or more test steps designed to run a test, automate a task, or control and monitor your power source or other instruments. The results of a test sequence are stored in a test report.

A test sequence file contains all the information necessary to run the test. This makes it easy to transfer the test sequence to another location or PC. When you open an existing test sequence file or create a new one using the Test Manager Button in the UPC Studio window, the test sequence window appears as shown.

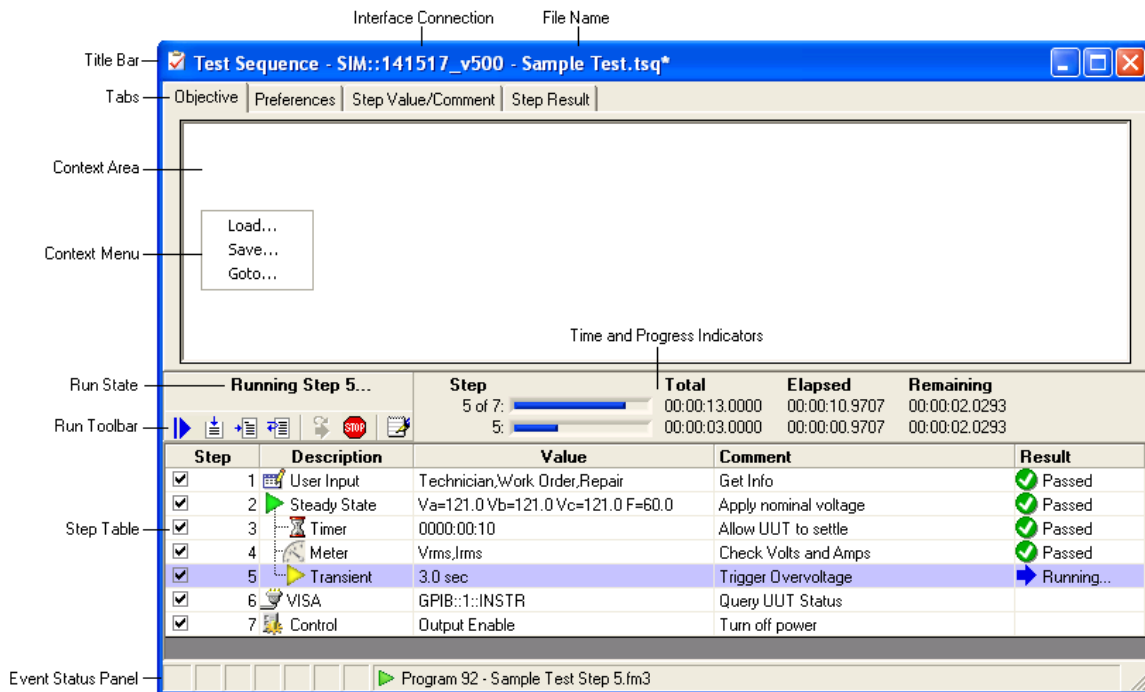

## 5.1.4 Title Bar

The title bar shows the interface used to connect to your UPC and the test sequence file name. An "\*" at the end means the file is currently being edited and the changes have not been saved. If the test sequence is part of a test plan, the test plan file name is shown first.



## 5.1.5 Objective Tab, Context Area and Context Menu

Selecting one of the tabs updates the **Context Area** with that item. In the above example, the **Objective** tab is selected. The objective is intended as a brief summary or description of the test sequence and is automatically included in the test report. You can type directly into the context area or copy and paste text or graphics from another application. Right-clicking the context area displays the

**Context Menu.** You can **Load** or **Save** the objective from a Rich Text (\*.rtf) or Plain Text (\*.txt) file. **Go-to...** shows the current cursor location and allows you to position the cursor to a particular line and column.

## 5.1.6 Preferences Tab

The **Preferences** tab shown below, displays general settings and file information for the test sequence.

Protect File —  Allow Edit Password:

File Info — File Path: C:\Visual Basic Projects\UPC Settings\Test Manager\Sample Test.tsq  
Last Updated: 07/20/2007 06:58:26

Program List — Use Programs: 90-99

Limits Table —

Limit	Value	Range
Frequency Min	15.00	15.00-1200.00 Hz
Frequency Max	1200.00	
Voltage Min	0.00	0.00-600.00 Vrms
Voltage Max	600.00	

Report Template:   Report Template

Lock Frequency Span — UPC-1/3 Only

You can protect a test sequence from inadvertent changes by un-checking the Allow Edit checkbox. For additional security, you can assign a Password. Once a password is assigned, you will be prompted to enter it in order to allow editing. The File Info section shows the full path of the test sequences database file and the last time it was updated. The program list defines which stored programs in your UPC the test sequence can use. These programs will be overwritten as necessary when running the test sequence. The program list can be a range (90-99), comma separated values (90, 93, 97) or both (90-93, 99). The Limits Table lets you to define the minimum and maximum frequency and voltage values allowable during the test. The test sequence will not run any program step (steady state or transient) that contain values outside these limits.

The Report Template shows which template is used with this test sequence. This is useful if the test sequence updates form fields in the report or you want the test sequence to always use a particular template. If this item is red, that template file is missing from the Templates folder (typically "C:\Pacific Power Source\UPC Manager\Test Reports\Templates"). Pressing the Load button initializes the report with that template (if it's not already loaded). Clicking the report template text box displays a drop-down list of template files installed on your computer that you can select. The "Manual" selection means the test sequence uses whatever template file is currently loaded. An "\*" means the test report has been updated



and changes have not yet been saved. Note: If the test sequence is opened from a test plan, the test plan report template is used.

If the Lock Frequency Span checkbox is checked, the highest frequency in the test sequence is used when setting the frequency span. This prevents the frequency span from changing and leaves the output enabled during the test. If this checkbox is not checked, the optimal (lowest) frequency span is selected for each step. This provides the maximum output waveform resolution and greatest metering accuracy but may cause the output to be temporarily disabled as the test runs. This checkbox is only available for UPC-1/3 based power sources.

### **5.1.7 Step Value/Comment and Step Result Tabs**

Refer to the Step Table topic for more information about these tabs. Note that these tabs apply to the currently selected step in the step table.







### **5.1.8 Run State**

The Run State section above the Run Toolbar shows the current status of the test. The various run states are shown below.

<b>Idle</b>	No test or steps have completed or are currently running.
<b>Running Step n...</b>	Step "n" is currently running.
<b>Stopped</b>	The test was stopped. The results column in the step table shows which step was stopped. A test is stopped by pressing the Stop button in the run toolbar or the Stop button in a User Prompt, User Input or Transient Prompt dialog box.
<b>Failed</b>	The test failed. The results column in the step table shows which step failed. Click in the results column for that step to view additional information.
<b>Done</b>	The test or selected step(s) have successfully completed.

### 5.1.9 Run Toolbar

The table below describes the buttons in the Run Toolbar. Some items (like Run Step) require one or more selected rows in the step table.

-  **Start** - Clears the test report then runs the entire test starting from step 1 (regardless of which step is currently selected).
-  **Continue** - Resumes the test starting with the currently selected row (step). The test continues to the last step.
-  **Run Step** - Runs the selected step(s) then pauses. Run Step is convenient for testing and troubleshooting.
-  **Run To Next** - Runs the selected step. When the step completes, the test pauses with the next row selected. Run To Next allows you to "single step" through a test sequence.
-  **Show Running Step** - When a test is running, pressing this button selects and shows the currently running step, scrolling the step table if necessary.
-  **Stop** - Stops the test and disables the power source output.
-  **Show Report** - Shows the test report window

Running a test using Start first initializes the test report then appends the test data to the report after each step completes. This creates a clean test report each time the test is run. Running a test using the other controls does not first clear the test report, making it easier to troubleshoot (single step etc) a test.

### 5.2 Time and Progress Indicators

The upper time and progress indicator shows the values for the entire test (all enabled steps) and the lower one shows the values of the selected step(s). The total time values update as step rows are selected making it easy to see when that step begins relative to the start of the test, even if a test is not running. The total time values take into account if step rows are not enabled (step checkbox not checked). Time and progress indicators are updated as the test runs. Step times are estimates based on the type of step, programmed values and system performance. Time values are shown in HH:MM: SS.SSSS format. The actual elapsed time of each step is recorded in the test report.

## 5.2.1 Step Table

Refer to the Step Table topic for more information.

## 5.2.2 Event Status Panel

Refer to the Event Status Panel section for more information on these items.

## 5.2.3 File Menu and Toolbar

The file menu and MDI toolbar (shown below) allow you to create a **new** test sequence, **open** an existing file, **Save** or **Save as...** (to a different file) or **Revert** the test sequence to the last saved version. The Save and Revert items are only enabled if the test sequence has been edited but not yet saved (the file name in the title bar shows an "\*" at the end).

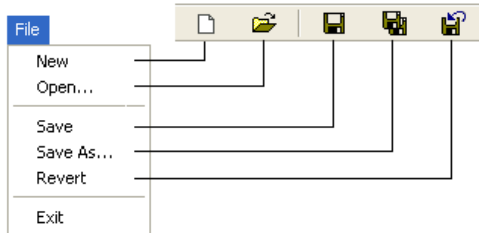

## 5.2.4 Step Table: Test Sequence Step Table

The step table shown below appears at the bottom of the Test Sequence window. The type and order of steps in the table defines the operations performed by the test sequence.

Step	Description	Value	Comment	Result
<input checked="" type="checkbox"/>	1  User Input	Technician,Work Order,Repair	Get Info	
<input checked="" type="checkbox"/>	2  Steady State	Va=121.0 Vb=121.0 Vc=121.0 F=60.0	Apply nominal voltage	
<input checked="" type="checkbox"/>	3  Timer	0000:00:10	Allow UUT to settle	
<input checked="" type="checkbox"/>	4  Meter	Vrms,Irms	Check Volts and Amps	
<input checked="" type="checkbox"/>	5  Transient	3.0 sec	Trigger Overvoltage	
<input checked="" type="checkbox"/>	6  VISA	GPIB::1::INSTR	Query UUT Status	
<input checked="" type="checkbox"/>	7  Control	Output Enable	Turn off power	

## 5.2.5 Adding or Removing Steps

If you right-click in the step table, the step context menu appears as shown below.

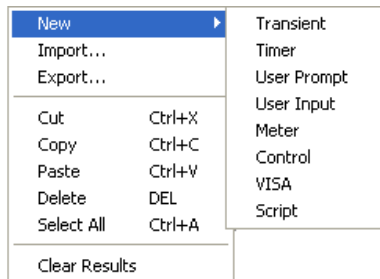

The menu items apply to the currently selected step(s). New steps are added or pasted after the selected step. To add a step at the beginning, first click the table header. To add a step at the end, first select the last step or click the blank area at the bottom of the table. The items in the step context menu are described below. For more information about each step type, click on one of the following topics: Steady State, Transient, Timer, User Prompt, User Input, Meter, Control, VISA, and Script.





<b>New</b>	Adds a new step after the selected step. There are 8 different step types to choose from. Note that the Transient step requires a prior Steady State step (see Import below).
<b>Import</b>	Loads a step from a file. You can load Output Sequence files (*.fm1, *.fm2, *.fm3) or test step files (*.tsp). Output sequence files contain Steady State and optional Transient values. If both are present, two steps are added after importing an output sequence.
<b>Export</b>	Saves the selected step to a file. When used with Import..., this is convenient for transferring steps from one test sequence to another.
<b>Cut</b>	Copies the selected steps to the clipboard and then deletes them from the table.
<b>Copy</b>	Copies the selected steps to the clipboard.
<b>Paste</b>	Pastes the clipboard after the selected step.
<b>Delete</b>	Deletes selected steps.
<b>Select All</b>	Selects all steps.
<b>Clear Results</b>	Clears the results column of the selected steps.

## 5.2.6 Step Table Columns

The columns in the step table are described below.

<b>Step</b>	Step enables checkbox and step number. Steps that aren't checked are skipped when the test sequence runs. Un-checking a step is a convenient way to temporarily disable a step while troubleshooting or reconfiguring a test.
<b>Description</b>	Step icon and name. Note that Transient steps are linked to a particular Steady State step. The description column for all steps up to and including the transient step is automatically indented.
<b>Value</b>	Shows a brief one-line summary of the values in the step. Clicking in the Value column for a particular step automatically selects the Step Value/Comment tab in the test sequence window, allowing you to edit the value.
<b>Comment</b>	Shows the step comment. Clicking in the comments column for a particular step automatically selects the Step Value/Comment tab in the test sequence window, allowing you to edit the comment.
<b>Result</b>	Shows the results state (Pass, Fail, Stopped, and Skipped) the last time this step was run. It also shows if a step is currently running. Clicking in the results column for a particular step automatically selects the Result tab in the test sequence window, providing additional information.

If the test sequence is part of a test plan, the step numbers in the step table contain a decimal point as shown below. The number to the left of the decimal point is the test plan step number and the number to the right is the test sequence step number.

Step	Description	Value
<input checked="" type="checkbox"/> 3.1	 Steady State	Va=120.0 Vb=120.0 Vc=120.0 F=60.0
<input checked="" type="checkbox"/> 3.2	 Meter	Vrms,Irms
<input checked="" type="checkbox"/> 3.3	 Transient	3.0 sec
<input checked="" type="checkbox"/> 3.4	 VISA	GPIB::1::INSTR
<input checked="" type="checkbox"/> 3.5	 Control	Output Enable

Test Plan Step Number | Test Sequence Step Number

## 5.2.7 Step Types: Control

The Control step allows the test sequence to change UPC setup parameters like CSC, Output Enable, and Transition Time etc. These items are normally defined in the Setup panel in the UPC Control window. The Control step design window is shown below.

Voltage and Frequency Limits

Objective Preferences Step Value/Comment Step Result

**Step 1 - Control**

Control Table

Item	Value
Transition Time	0.1000
ProgZo State	On

Output Warning

Right-click table to add/remove item. Drag "Item" column to reorder rows.  
 ⚡ Changing this item may temporarily disable the output.

Comment: Ramp Mode and ProgZo

Idle	Step	Total	Elapsed	Remaining
	1 of 1:	00:00:00.0000	00:00:00.0000	00:00:00.0000
	1:	00:00:00.0000	00:00:00.0000	00:00:00.0000

Step Table

Step	Description	Value	Comment	Result
1	Control	Transition Time, ProgZo State	Ramp Mode and ProgZo	

The Control Table contains entries that change UPC setup values. To change an existing entry, click in the value column for that row. To add a new item, right-click the item column to activate the Control Menu as shown below.

Add	▶	Output Enable
Delete	DEL	CSC
		Beep
		ProgZo State
		ProgZo Ohms
		Initial Voltage
		Volt Sense
		Range Control
		Frequency Span
		Transition Time
		Current Protect
		Local Lockout
		Keyboard Lock

The items in the menu vary depending on the features supported by your power source. Items already in the table are disabled (grayed). Selecting one of these

items adds it to the table. The new item is added after the row you right-clicked the mouse. To add an item at the beginning, right-click the Item column in the table header. To add an item at the end, right-click the Item column of the last row. The order of the items in the table is not critical but you can rearrange them by clicking the item column for a row and dragging it to the new location. To delete a row, click the item column for that row then press the Delete key.

The text you enter in the Comment box automatically appears in the step table and test report.

Notes:

- The Steady State and Transient test steps automatically enable the output and select the optimum frequency span so it's not necessary to add a control step to do this.
- Depending on your UPC model, changing some items may temporarily disable the output. These items are marked with the Output Warning icon
- The Output Enable value may actually change first or last depending on whether it's being enable or disabled and the other items and values in the control table that you specified.
- Avoid using multiple control steps back-to-back to only change one item. Changing all needed items in one step reduces output enable changes and speeds up the test.
- Only include items that need changing. Including unnecessary items slows down the test and may unintentionally change a value set by another step. To delete a row, click the item column for that row then press the Delete key.
- The voltage and frequency limit values can only be set in the test sequence Preferences tab.
- The control table does not allow changing the hardware configuration (Transformer Ratio, Amps Volts Ratio, CT Location, Amplifiers).
- The value of the Beep item controls the UPC beep duration

### 5.3 Meter

The Meter step allows the test sequence to measure voltage, current, power, frequency, harmonics and waveforms using the built-in metering functions in your

UPC. These functions are normally performed manually using the UPC Meter Window. The meter step also supports limit checking, out-of-limit behavior and data logging.

When a test sequence runs a Meter step, the requested measurements are made, updating the progress/time indicators and step result with the measured values. If specified, limit checking is also performed on the measured values. If you specify that the test should fail if a value is outside the limits, the test will stop with "Failed" results. Pressing the Stop Button in the Run Toolbar stops the test with "Stopped" results. When the Meter step is allowed to complete, the test sequence proceeds with the next step.

The Meter step design window is shown below.

The screenshot displays the 'Step 1 - Meter' configuration window. At the top, there are tabs for 'Objective', 'Preferences', 'Step Value/Comment', 'Step Result', and 'Measurement Results'. Below these are sub-sections for 'Output Form', 'Limit Action Menu', and 'Data Log Controls'. The 'Type' is set to 'V, I, F, Power', 'Form' is '3', and 'If Outside Limits' is 'Fail'. 'Samples' is 5 and 'Interval' is 1 second. The 'Meter Function/Limits Table' has three rows for phases A, B, and C. Each row has checkboxes for 'Vrms' and 'Irms' and associated limit values. A 'Comment' field contains 'Check Volts and Amps'. The 'Run Toolbar' shows 'Idle' and 'Step' indicators with a 'Stop' button. The 'Step Table' at the bottom is as follows:

Step	Description	Value	Comment	Result
<input checked="" type="checkbox"/>	1 Meter	Vrms,Irms	Check Volts and Amps	



The Meter Type Menu selects which measurement category you want to use. The choices are shown below.

Meter Type	Available Functions	Limit Checking	Data Log
V,I,F,Power	Vrms, Vrms(L-L), Irms, Ipeak, Icrest, KW, KVA, PF, Freq, Degrees	Yes	Yes
Volts Harm %	THD, OHD, EHD, Magnitude (1-51), Phase (1-51)	Yes	Yes
Amps Harm %	THD, OHD, EHD, Magnitude (1-51), Phase (1-51)	Yes	Yes
Volts Harm Abs	THD, OHD, EHD, Magnitude (1-51), Phase (1-51)	Yes	Yes
Amps Harm Abs	THD, OHD, EHD, Magnitude (1-51), Phase (1-51)	Yes	Yes
Waveform	Volts, Amps	No	No

The **Output Form** menu specifies the data format of the metered data. An error occurs if the present UPC output form (set by a previous [Steady State](#) step) does not match this setting when the meter step is run.

The Meter Function/Limits Table allows you to specify which functions are measured and any limit checking you want performed. To add a function to the table, right-click the header of the table and the Meter Function menu appears. Shown below are the V, I, F, Power and Harmonics meter function menus.

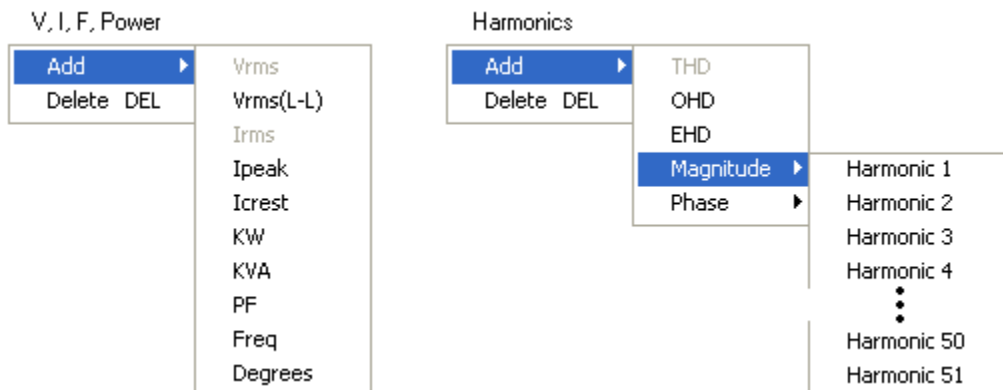

Items already in the table are disabled (grayed). The new item is added after the column you clicked the mouse. You can rearrange columns by click the table header for that column and dragging it to the new location. To delete a column (function), click the mouse in the column header then press Delete. The order the columns appear in the table is also the order the measurement appears in the Step Result tab and test report.

For maximum performance, include only the meter functions and phases you need. Un-checking the Measure Checkbox allows you to skip that function/phase from being measured. When metering output form 2, the Vrms(L-L) function should be used instead of Vrms.. Each measured value can be checked against none, one or two limit values. This allows high/low range checking for each measured value. Limit entries can use any of the following relational operators followed by a number.

Operator	The measured value must be...
>	Greater than
>=	Greater than or equal to
<	Less than
<=	Less than or equal to
=	Equal to
<>	Not equal to

The **Limit Action Menu** controls what happens if a measured value is outside the limits. **Continue** means the meter step completes normally. **Fail** means the meter step stops the test with "Failed" results. In either case, the out-of-limit measured value is highlighted in red in the **Step Result** tab and test report.

#### \Data Logging

The **Data Log Controls** specify the number of measurement **Samples** and time **Interval** between measurements. Data logging allows you to monitor values over an extended period of time. When making multiple measurements, the total time the meter step takes is  $(\text{Samples} - 1) * \text{Interval}$ . The first measurement is taken immediately when the meter step starts running. The meter step completes immediately after the last measurement is made (no final delay). Specifying short time intervals between measurements may not be achievable with your power source or PC. The Step Result tab and test report shows the actual elapsed time of each measurement and is highlighted in red if it didn't achieve the interval you

specified. The progress/time indicators update as the step runs and the Step Result tab lets you view measurements as they are being made. Data log measurement samples are stored in separate rows as shown below.

Date/Time	Elapsed	Vrms(L-N) A	Vrms(L-N) B	Vrms(L-N) C	Irms A	Irms B	Irms C
07/24/2007 09:57:54	0	120.120	120.051	120.033	6.483	6.481	6.470
07/24/2007 09:57:54	0.500	120.104	120.058	120.023	6.484	6.480	6.470
07/24/2007 09:57:55	1.000	120.117	120.076	120.036	6.484	6.480	6.470
07/24/2007 09:57:55	1.604	120.102	120.065	120.027	6.484	6.481	6.470
07/24/2007 09:57:56	2.104	120.098	120.073	120.038	6.484	6.480	6.753

Time Interval Not Achieved

Outside Limit

#### Notes:

- When requesting a single sample, each phase uses a separate row in the step result and test report, similar to the layout of the Meter Function Table in the meter design window.
- Setting Local Keyboard Lock (local lockout) ON and CSC Off improves metering performance.

### 5.3.1 Waveform Metering

When using **Waveform** in the Meter Type menu, the actual voltage and current waveforms for each selected phase (1 cycle) are plotted in a graph and stored in the Step Result tab and test report.

## 5.4 Script

The Script step allows the test sequence to perform custom operations using Microsoft Visual Basic Scripting. In addition to the full VBScript language support, the script has access to various test manager objects. Scripts are very fast and efficient and run without needing a compiler or other programming tools. The Script step design window is shown below.

The screenshot shows the 'Script' step design window in UPC Studio. The window is titled 'Step 1 - Script' and has tabs for 'Objective', 'Preferences', 'Step Value/Comment', and 'Step Result'. The main area is divided into a 'Code Window' for editing VBScript code and a 'Comment' field. The code includes constants for kScriptTime and kTimeout, and a Sub ScriptMain() that sets the test result to 'Hello World!'. Below the code window is a 'Run Toolbar' with buttons for Run, Stop, and other actions. At the bottom is a 'Step Table' showing the current step's details.

Step	Description	Value	Comment	Result
1	Script	Test Manager Script Starter Code	"Hello World" Demo	

The above example shows the default script created when you add a new Script step to the step table. The script starter code simply puts "Hello World!" in the Step Result tab and test report. You can enter or edit code directly in the Code Window and immediately run it using the Run Toolbar. Running a script step calls the Script Main subroutine.

The first line of the script (usually a comment) appears in the value column of the step table. Two optional constants at the top of the code window define time information (seconds) used by the test sequence prior to running the script. kScriptTime is the step time estimate used for the progress/time indicators and kTimeout is the maximum time the script should be allowed exclusive control your PC before a message box is displayed asking if you want to cancel the script.

### 5.4.1 Test Manager Object Reference

This section defines the various methods and properties available to a script. Test manager objects begin with "TM".

#### Notes:

- The range for program numbers is 0-99, where 0 refers to the Manual Mode program.
- Script coding errors (syntax and run-time) are reported in the Step Result tab.
- Use Go-to ... in the Context Menu to view the current cursor location or locate a particular line and column.
- Scripts can use the Step object to read but not change the values and result of any step in the Step Table.
- When a script starts, the prior results are automatically cleared. You can use form fields in the test report to simulate "global" variables or to pass values between script steps.
- To assist troubleshooting and debugging, use TM.RunMsgBox and TM.RunInputDialog to show or enter variables.
- Do not use TM.RunVisa to change values of your power source. Instead, use the methods and properties provided by the Run and UPC objects.
- Creating and debugging scripts require prior programming experience with VBScript. Contact Pacific Power for assistance in developing custom scripts.
- The property Get and Let definitions listed below should be treated as variable assignments (e.g. result = TM.RunErrCode or TM.RunStepProgress = t) in your script code.

### 5.4.2 Run Object

#### Public Property Get TM.RunStep () As Integer

Returns the step number currently running (the script step).

#### Public Property Get TM.RunNextStep () As Integer

Returns the step number that will be run after the script step completes. The default value is 0 which means to run the next step.

### **Public Property Let TM.RunNextStep (ByVal step As Integer)**

Sets the step number to be run after the script step completes. The default value is 0 which means to run the next step. Changing the next step is essentially the same as a "Go-to". Be careful when changing TM.RunNextStep because it makes the test difficult to analyze and can create endless loop situations.

### **Public Property Get TM.StepElapsedTime () As Double**

Returns the elapsed time in seconds since the script step started.

### **Public Property Let TM.RunStepProgress (ByVal elapsed As Double)**

Updates the progress and time indicators with "elapsed" time

### **Public Property Get TM.RunStepPercent () As Single**

Returns the step percentage completed.

### **Public Property Let TM.RunStepPercent (ByVal percent As Single)**

Updates the progress and time indicator with the "percent" complete. Only applies if kScriptTime = 0.

### **Public Sub TM.RunDoEvents ()**

Gives the test manager time to update (not normally necessary).

### **Public Function TM.RunUserPrompt (ByVal Caption as String, ByVal prompt As String) As Integer**

Displays a User Prompt window. Refer to the TM.RunCodeXXX properties for the return values. "Caption" is the title bar of the window and "prompt" can be Rich or Plain Text.

### **Public Function TM.RunUserInput (ByVal Caption As String, ByVal parameter As String, result As Variant) As Integer**

Displays a User Input window. Refer to the TM.RunCodeXXX properties for the return values. "Caption" is the title bar of the window and "parameter" is a formatted string that defines the input table rows and columns. "Result" is a string

containing the values input by the user. Refer to the `TM.ReportInputXXX` properties for constants that define the various input types (Textbox, Checkbox, and Listbox). The easiest way to determine the "parameter" string format is to create a user input step and export it to a file then examine the files contents.

### **Public Function `TM.RunControl (ByVal param As String) As String`**

Updates UPC setup values. The easiest way to determine the "param" string is to create a Control step and export it to a file then examine the file contents. The return value is the query response string.

### **Public Function `TM.RunVisa (ByVal param As String) As String`**

Sends a command string to an instrument and return the response. The easiest way to determine the "param" string is to create a Visa step and export it to a file then examine the file contents. You only need to include values that relate to the interface (resource) you are using. If the "command" uses commas, you must replace them with `TM.VisaCommaChar`. The comma will be restored when the VISA step runs.

`Public Function TM.RunProgramDefine(ByVal progNum As Integer, ByVal field As String, ByVal data As String, Optional ByVal prefix As String) As Boolean`  
Sends a program define string to the UPC. You can send a single "field" with "data" or group multiple fields together. When updating multiple fields, the "field" contains comma delimited field and data pairs except skip the final comma and data value. Then set the "data" value to the data for the last field. Refer to the UPC Operation Manual for the available program define fields and data values. Returns True if the program define was sent successfully.

### **Public Function `TM.RunProgram (ByVal progNum As Integer) As Boolean`**

Executes a program. Return False if the program is not stored.

### **Public Function `TM.RunTransient () As Boolean`**

Triggers a transient. Returns True when the transient completes.

### **Public Sub `TM.RunErrClear ()`**

Clears the test manager error state. This is normally used when the script uses "On Error Resume Next" and you want to handle errors and continue.

### **Public Property Get TM.RunErrCode () As Integer**

Returns the current error code. Refer to the TM.RunCodeXXX properties for the return values. This property allows you to determine if the test manager has generated an error.

### **Public Property Let TM.RunErrCode (ByVal errCode As Integer)**

Sets the error code. Refer to the TM.RunCodeXXX properties for the available values.

### **Public Property Get TM.RunErrDate () As Date**

Returns the date and time the error reported by TM.RunErrCode occurred.

### **Public Property Let TM.RunErrDate (ByVal errDate As Date)**

Sets the data and time the error occurred.

### **Public Property Get TM.RunErrDesc () As String**

Returns a description of the error reported by TM.RunErrCode.

### **Public Property Let TM.RunErrDesc (ByVal errDesc As String)**

Sets the description of the error.

### **Public Property Get TM.RunCodeRun () As Integer**

Returns the value for the "Running" state. This is the normal state of a step when it's running.

### **Public Property Get TM.RunCodeStop () As Integer**

Returns the value for the "Stopped" state. This is the state when a step is stopped.

### **Public Property Get TM.RunCodeDone () As Integer**

Returns the value for the "Done" state ("Passed"). This is the state when a step has completed normally.



### **Public Property Get TM.RunCodeFailed () As Integer**

Returns the value for the "Failed" state. This is the state when a step has failed.

### **Public Property Get TM.RunCodeSkipped () As Integer**

Returns the value for the "Skipped" state. This is the state when the test sequence attempts to run a step and the enable checkbox is not checked.

### **Public Function TM.RunMsgBox (ByVal prompt As String, Optional ByVal flags As Long = vbOKOnly, Optional ByVal title As String = "VBScript") as integer**

Calls the standard Visual Basic MsgBox function modally in the test manager workspace.

### **Public Function TM.RunInputBox (ByVal prompt As String, Optional ByVal title As String = "VBScript") as integer**

Calls the standard Visual Basic InputBox function modally in the test manager workspace.

## **5.4.3 Step Object**

### **Public Property Get TM.StepEnabled (ByVal i As Integer) As Boolean**

Returns the enable checkbox state of the requested step.

### **Public Property Get TM.StepType (ByVal i As Integer) As Integer**

Returns the numeric index of the type of the requested step.

### **Public Property Get TM.StepDesc (ByVal i As Integer) As String**

Returns the description of the requested step.

### **Public Property Get TM.StepComment (ByVal i As Integer) As String**

Returns the comment of the requested step.

**Public Property Get TM.StepSeconds (ByVal i As Integer) As Single**

Returns the time estimate of the requested step.

**Public Property Get TM.StepInvalid (ByVal i As Integer) As Boolean**

Returns True if the requested step contains invalid values.

**Public Property Get TM.StepSummary (ByVal i As Integer) As String**

Returns the text summary for the values of the requested step.

**Public Property Get TM.StepParameter (ByVal i As Integer) As String**

Returns the parameter value of the requested step.

**Public Property Get TM.StepCount () As Integer**

Returns the total number of steps in the test sequence.

**Public Property Get TM.StepResultCode (ByVal i As Integer) As Integer**

Returns the result code of the requested step. Refer to the TM.RunCodeXXX properties for the available values.

**Public Property Get TM.StepResultDate (ByVal i As Integer) As Date**

Returns the date and time the requested step completed.

**Public Property Get TM.StepResultElapsed (ByVal i As Integer) As Single**

Returns the elapsed time in seconds the requested step took to complete.

**Public Property Get TM.StepResultTitle (ByVal i As Integer) As String**

Returns the result title (Passed, Stopped, Failed, and Skipped) of the requested step.

**Public Property Get TM.StepResultRtf (ByVal i As Integer) As String**

Returns a Rich Text string of the result data for the requested step.

**Public Property Get TM.StepResultSelected (ByVal i As Integer) As Boolean**

Returns True if the Result tab for requested step is currently selected.

**Public Property Get TM.StepReportFlags (ByVal i As Integer) As Integer**

Returns the report flags of the requested step. Refer to the TM.ReportStepXXX properties for the available flags.

**Public Property Let TM.StepReportFlags (ByVal i As Integer, ByVal report As Integer)**

Sets the report flags of the requested step. Refer to the TM.ReportStepXXX properties for the available flags. To include multiple items, add them together (i. e. TM.ReportStepTitle + TM.ReportStepResultTitle + TM.ReportStepResultData)

#### 5.4.4 Report Object

**Public Sub TM.ReportGetInfo (path As Variant, fileDirty As Variant, template As Variant)**

Sets "path" to the current report file path. Sets "fileDirty" to True if the file has been changed but not saved. Sets "template" to the current template name.

**Public Function TM.ReportSave (ByVal path As String) As Boolean**

Saves the test report to the file specified by "path". Returns True if the file was successfully saved.

**Public Function TM.ReportGetTemplate (ByVal Index As Integer, name As Variant) As Boolean**

Sets "name" to the template name of the specified index. This function allows you to query the available templates. Start with an index of 0 and continue until the function returns False.

### **Public Function TM.ReportSetTemplate (ByVal name As String) As Boolean**

Changes the report template to "name". This also clears the test report. Returns True if the template name exists and the report was initialized.

### **Public Function TM.ReportGetFieldInfo (ByVal Index As Integer, name As Variant, checkboxfield As Variant) As Boolean**

Returns information about the form fields in the test report. Sets "name" to the field name. Sets "checkbox" to True if the field is a checkbox. This function allows you to query the available form fields in the current test report. Start with an index of 0 and continue until the function returns False.

### **Public Function TM.ReportGetField (ByVal name As String, Val As Variant, ByVal checkbox field As Boolean) As Boolean**

Sets "Val" to the value of the form field specified by "name". Sets "checkbox field" to True if the field is a checkbox. Returns False if the requested field name does not exist in the test report.

### **Public Function TM.ReportSetField (ByVal name As String, ByVal val As String, ByVal checkboxfield As Boolean) As Boolean**

Sets the form field specified by "name" to "val". You must set "checkboxfield" to True if the field type is a checkbox. Returns False if the requested field name does not exist or the checkbox field value does not match the actual field type in the report.

### **Public Property Get TM.ReportStepTitle () As Integer**

Returns a constant that controls if the step title is included in the test report. See StepReportFlags above.

### **Public Property Get TM.ReportStepSummary () As Integer**

Returns a constant that controls if the step summary is included in the test report. See StepReportFlags above.

**Public Property Get TM.ReportStepComment () As Integer**

Returns a constant that controls if the step comment is included in the test report. See StepReportFlags above.

**Public Property Get TM.ReportStepResultTitle () As Integer**

Returns a constant that controls if the step result title is included in the test report. See StepReportFlags above.

**Public Property Get TM.ReportStepResultData () As Integer**

Returns a constant that controls if the step result data is included in the test report. See StepReportFlags above.

**Public Property Get TM.ReportStepAll () As Integer**

Returns a constant that controls if the all step items are included in the test report. See StepReportFlags above.

**Public Property Get TM.ReportRtfClear () As String**

Returns a string that can be used to reset formatting and clear text in a RichTextBox.

**Public Property Get TM.ReportGraphWidth () As Long**

Returns the width in pixels of the waveform graph created by the Meter step.

**Public Property Let TM.ReportGraphWidth (ByVal Width As Long)**

Sets the width in pixels of the waveform graph created by the Meter step.

**Public Property Get TM.ReportGraphHeight () As Long**

Returns the height in pixels of the waveform graph created by the Meter step.

**Public Property Let TM.ReportGraphHeight (ByVal Height As Long)**

Sets the height in pixels of the waveform graph created by the Meter step.

### **Public Property Get TM.ReportInputTextbox () As Long**

Returns a constant that defines the Textbox type used for the TM.RunUserInput function "parameter".

### **Public Property Get TM.ReportInputCheckbox () As Long**

Returns a constant that defines the Checkbox type used for the TM.RunUserInput function "parameter".

### **Public Property Get TM.ReportInputListbox () As Long**

Returns a constant that defines the Listbox type used for the TM.RunUserInput function "parameter".

## **5.4.5 UPC Object**

### **Public Function TM.UpcGetProgramNameCRC (ByVal progNum As Integer, name As Variant, crc As Variant) As Boolean**

Sets "name" to the output sequence file name and "crc" to the program CRC for the specified program. Returns False if no program is stored at "progNum".

### **Public Function TM.UpcGetExecutingProgram () As Integer**

Returns the currently executing program number. 0 is the Manual Mode program and -1 means no program is currently executing.

### **Public Property Get TM.UpcGetInfo () As String**

Returns info about the UPC you are currently connected (IDN, serial number, supported features etc).

### **Public Property Get TM.UpcGetSetup () As String**

Returns the setup and configuration values of the UPC.

**Public Property Get TM.UpcGetProgram (ByVal progNum As Integer) As String**

Returns the program values (Steady State and Transient) of the requested program.

**Public Property Get TM.UpcGetkFactors () As String**

Returns the kFactors calibration data of the UPC.

**Public Property Get TM.UpcGetProgZoCal () As String**

Returns the ProgZo calibration data of the UPC.

**Public Function TM.UpcGetWaveform(ByVal wf As Integer, title As Variant, source As Variant, dateTime As Variant, comments As Variant, crc As Variant, maxVrms As Variant, rmsFactor As Variant, dcOffset As Variant, data As Variant) As Boolean**

Returns waveform values of waveform "wf". "data" is set to an array of 1024 values ranging from -100 to +100 percent. The waveform values are shown in the Waveform Editor window.

**Public Function TM.UpcSetWaveform(ByVal wf As Integer, title As Variant, source As Variant, dateTime As Variant, comments As Variant, data As Variant) As Boolean**

Sets the values for waveform "wf". "data" is an array of 1024 values ranging from -100 to +100 percent. The waveform values are shown in the Waveform Editor window.

For maximum performance and to reduce memory usage, it's best to set "source" to TM.UpcWaveformNoDatabase to prevent the waveform from being added to the waveform reference database. It's also recommended you restore any waveforms you change back to a sine wave. To restore a waveform to a sine wave, use TM.UpcGetWaveform (1 ...) to read waveform 1 (it's always a sine wave) then use TM.UpcSetWaveform to reset it.

Note: TM.UpcSetWaveform disables the output.

### **Public Function TM.UpcGetEvents () As String**

Returns a string of event tokens currently showing the Event Status Panel. The tokens (description) are "CAPTURE" (probe capture), "ERR" (Error), "PON" (power on), "SHUTDOWN" (power source shutdown), "URQ" (user request), "IPROT" (current protect), "VPROT" (voltage protect), "NR" (remote interface not responding) and "BSY" (remote interface busy).

### **Public Sub TM.UpcClearEvents ()**

Resets all events in the Event Status Panel.

## **5.4.6 Rich Textbox Objects**

Scripts have access to three rich textbox objects. These are standard Visual Basic RichTextBox controls. Refer to the Microsoft documentation for the available properties and methods. These controls allow you to create and manipulate formatted text and graphics. You can access these controls using TM.RtfProgress, TM.RtfResults and TM.RtfTemp. The contents of TM.RtfProgress are shown in the step result tab and test report when the script completes. Use RtfTemp for a scratch pad but keep in mind that the contents may be changed by other test manager objects. RtfResults allows you to dynamically update the step result tab (like the Meter step does during data logging) while the script is running. You should only update RtfResults if TM.StepResultSelected returns True for your script step. To initialize the contents of a rich textbox, use TM.RtfTemp.TextRTF = TM.ReportRtfClear.

## **5.5 Steady State**

The Steady State step allows the test sequence to set the power source output voltage, frequency, phase, and waveform, output form, coupling and current limit.

Use **Import...** in the step table context menu to import output sequence files into the step table. Output sequences contain steady state and optional transient values. These appear as two separate rows in the **Step Table** linked together. Clicking on the steady state step shows the values in the **Context Area**. Red text indicates values outside the limits defined in the Preferences tab or values not supported by your power source (i.e. Form or Coupling). Click the Preferences tab to view and edit the limits. Note that the limits apply to all Steady State and Transient steps in the test sequence. You can delete the transient step if you only want the steady state values to be used in the test.



The test sequence will not run steps that contain invalid values. When running a steady state step, the test sequence stores the output sequence in one of the programs you specified in the program list in the Preferences tab. It then executes the steady values and enables the output.

To edit the steady state values, double click the steady state step in the step table. The output sequence window will appear allowing you to make changes. Click the Save button in the output sequence window toolbar to save the changes to the test sequence. Test sequences store the actual contents of the output sequence you imported. This means changes to the Steady State or Transient steps in the test sequence do not affect the original output sequence file.

The **Context Menu** allows you to save the steady state values to a Rich Text (\*.rtf) or Plain Text (\*.txt) file. The text you enter in the **Comment** box automatically appears in the step table and test report.

The screenshot displays the 'Preferences Tab' window in upcstudio. The 'Step Value/Comment' tab is active, showing the configuration for 'Step 1 - Steady State'. The 'Context Area' contains the following parameters:

Phase	Volts	Waveform	Degrees
A	120.000000	1-Sine	0
B	120.000000	1-Sine	120
C	120.000000	1-Sine	240

Additional parameters include: Form: 3, Frequency: 60.000000, Coupling: DIRECT, Current Limit: 13.333333 Amps, Transient: Time based, 2 segments, and CRC: 31099. A 'Context Menu' is visible with options: Load..., Save..., and Goto... The 'Comment' field contains 'Apply nominal voltage'.

Below the configuration is a progress bar and a 'Step Table' with the following data:

Step	Description	Value	Comment	Result
1	Steady State	Va=120.0 Vb=120.0 Vc=120.0 F=60.0	Apply nominal voltage	
2	Transient	Infinite (8.0)	Overvoltage Surges	

## 5.5.1 Timer

The Timer step inserts a delay in the test sequence. The Timer step design window is shown below.

The screenshot shows the 'Timer' step configuration interface. It includes a 'Time Controls' section with spinners for hours, minutes, and seconds. A 'Comment' field is present for user-defined text. The 'Run Toolbar' contains standard test execution controls. The 'Step Table' at the bottom provides a summary of the step configuration.

Step	Description	Value	Comment	Result
1	Timer	0000:02:30	Allow UUT to settle	

Use the Time Controls to enter the desired delay time. The SECONDS value can be entered in SS.SSSS format. The time value is also shown in the value column of the step table. When a test sequence runs a Timer step, the progress/time indicators update. Pressing the Stop Button in the Run Toolbar stops the test with "Stopped" results. When the Timer step is allowed to complete, the test sequence proceeds with the next step.

The text you enter in the Comment box automatically appears in the step table and test report.

## 5.6 Transient

The Transient step allows a test sequence to vary the power source output voltage, frequency and waveform at precisely defined intervals. Use New->Transient in the step table context menu to add a transient step to the step table. Transients are defined in output sequences. Refer to the Steady State step for instructions on importing output sequences into a test sequence.

Output sequences contain steady state and optional transient values. These appear as two separate rows in the Step Table linked together. Selecting the transient step shows the values in the Context Area. Red text indicates values outside the limits defined in the Preferences tab or values not supported by your

power source. Click the Preferences tab to view and edit the limits. Note that the limits apply to all Steady State and Transient steps in the test sequence. You can delete the transient step if you only want the steady state values to be used in the test.

The test sequence will not run steps that contain invalid values. When running a transient step, the test sequence stores the output sequence in one of the programs you specified in the program list in the Preferences tab. It then enables the output then triggers the transient. When the transient completes, the power source returns to the steady state values. Pressing the Stop Button disables the output, stops the transient then return the power source to the steady state values. Since running a transient step is simply triggering the transient portion of the output sequence, you can add as many transient steps as you want. You can also add other step types (Meter, User Prompt, Timer, etc) between the steady state and transient steps.

To edit the transient values, double click the steady state or transient step in the step table. The output sequence window will appear allowing you to make changes. Click the Save button in the output sequence window toolbar to save the changes to the test sequence. Test sequences store the actual contents of the output sequence you imported. This means changes to the Steady State or Transient steps in the test sequence do not affect the original output sequence file.

The Context Menu allows you to save the transient values to a Rich Text (\*.rtf) or Plain Text (\*.txt) file. The text you enter in the Comment box automatically appears in the step table and test report.

The time estimate in the progress/time indicator and step table value column is based on the transient time.

Min - Max Time Limit

Objective | Preferences | Step Value/Comment | Step Result

**Step 2 - Transient** Time Limit: 23.5 - 4:17

Type: Time Event Time: 1.0 sec Events: Infinite Total Time: Infinite (23.5 - 4:17.0) Segments: 2+CR

Segment	Frequency	Va	Vb	Vc	Waveform A	Waveform B	Waveform C	Duration
SS	60.000000	120.000000 V	120.000000 V	120.000000 V	1-Sine	1-Sine	1-Sine	---
1	60.000000	135.000000 V	135.000000 V	135.000000 V	1-Sine	1-Sine	1-Sine	0.500000 Sec
2	60.000000	120.000000 V	120.000000 V	120.000000 V	1-Sine	1-Sine	1-Sine	0.500000 Sec
CR	60.000000	120.000000 V	120.000000 V	120.000000 V	1-Sine	1-Sine	1-Sine	0.000000 Sec

Transient Prompt Message

Comment:

Idle	Step	Total	Elapsed	Remaining
	2 of 2:	00:04:17.0000	00:00:00.0000	00:04:17.0000
	2:	00:04:17.0000	00:00:00.0000	00:04:17.0000

Step	Description	Value	Comment	Result	
<input checked="" type="checkbox"/>	1	Steady State	Va=120.0 Vb=120.0 Vc=120.0 F=60.0	Apply nominal voltage	
<input checked="" type="checkbox"/>	2	Transient	Infinite (23.5 - 4:17.0)	Overvoltage Surge - Wait for min time then...	

Time Estimate

## 5.6.1 Infinite Transient

The output sequence window allows you to specify an infinite number of events for a transient. Since the total transient time is the event time multiplied by the number of events, this means the total transient time is infinite. Infinite transients are useful if you need to precisely vary the power source output over an extended period of time. However, using an infinite transient in a test sequence would prevent the test from proceeding past the transient. The only way to cancel it is to press the stop button in the Run Toolbar.

The transient step allows you to override an infinite transient by specifying an optional **Min Time** and **Max Time** you want the transient to run. Shown below is an infinite transient step with a min and max time limit. The time values are in HH:MM: SS.SSSS format. The estimate shown in the progress/time indicator and step table value column is based on the max time.

Objective | Preferences | Step Value/Comment | Step Result | Min - Max Time Limit

**Step 2 - Transient** Time Limit: 23.5 - 4:17

Type: Time Event Time: 1.0 sec Events: Infinite Total Time: Infinite (23.5 - 4:17.0) Segments: 2+CR

Segment	Frequency	Va	Vb	Vc	Waveform A	Waveform B	Waveform C	Duration
SS	60.000000	120.000000 V	120.000000 V	120.000000 V	1-Sine	1-Sine	1-Sine	---
1	60.000000	135.000000 V	135.000000 V	135.000000 V	1-Sine	1-Sine	1-Sine	0.500000 Sec
2	60.000000	120.000000 V	120.000000 V	120.000000 V	1-Sine	1-Sine	1-Sine	0.500000 Sec
CR	60.000000	120.000000 V	120.000000 V	120.000000 V	1-Sine	1-Sine	1-Sine	0.000000 Sec

Transient Prompt Message

Comment: Overvoltage Surge - Wait for min time then check UUT.

Step	Idle	Step	Total	Elapsed	Remaining
2 of 2			00:04:17.0000	00:00:00.0000	00:04:17.0000
2:			00:04:17.0000	00:00:00.0000	00:04:17.0000

Step	Description	Value	Comment	Result
1	Steady State	Va=120.0 Vb=120.0 Vc=120.0 F=60.0	Apply nominal voltage	
2	Transient	Infinite (23.5 - 4:17.0)	Overvoltage Surge - Wait for min time then...	

Time Estimate

When an infinite transient is running, the Transient Prompt window appears as shown below.

Step Number | Test Sequence Name

**Step 2 - Transient [Sample Test]**

**Overvoltage Surge - Wait for min time then check UUT.** Transient Prompt Message

Transient Time (HH:MM:SS) = 00:00:52.3945

00:00:23.5000 | 00:04:17.0000

Min Time | Max Time

Stop Fail Pass Pass Button

The window uses the comment text for the Transient Prompt Message and shows the transient progress. Stopping a transient before the min time is reached will stop the test. You must press the Pass button before the max time is reached, otherwise the test will stop. If you only enter a max time limit, the transient step will pass when Max Time is reached and the test will proceed to the next step.

The title bar of the window shows the step number and test sequence file name. If the test sequence is part of a test plan, the test plan step number and file name are shown first.

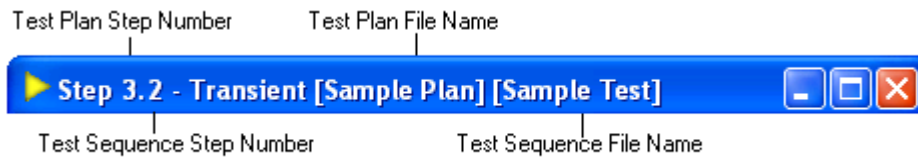

## 5.6.2 User Input

The User Input step allows the test sequence to ask the user to enter one or more values. Shown below is the User Input design window.

The screenshot shows the 'Step 1 - User Input' design window. It includes a 'Preamble' field with the text 'Enter values for the following items:'. Below this is an 'Input Table' with the following data:

#	Prompt	Type	Initial Value	Report Field
1	Customer	Textbox		CUSTOMER
2	Repair	Checkbox	Off	REPAIR
3	Technician	Listbox	Dan	TECHNICIAN

Below the table is a 'Comment' field with the text 'Get Info'. At the bottom, there is a 'Run Toolbar' with buttons for 'Idle', 'Step', 'Total', 'Elapsed', and 'Remaining'. The 'Step' section shows '1 of 1' and '1:'. The 'Total', 'Elapsed', and 'Remaining' sections show '00:00:00.0000'. At the very bottom is a 'Step Table' with the following data:

Step	Description	Value	Comment	Result
1	User Input	Technician, Customer, Repair	Get Info	

The Preamble is the message displayed at the top of the User Input window (shown below) to provide instructions to the user. The input table contains the items you want the user to supply when the step runs. To add or delete items (rows), right-click in the step column (#) and the input table context menu appears as shown below. New rows are added after the row you clicked the mouse. To add a row at the beginning, right-click the table header. To add a row at the end, right-click the last row. To rearrange rows, click the row in the step column (#) and drag it to the new position.

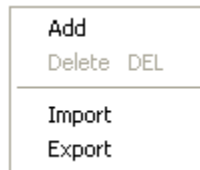

The Prompt column is the title or brief description of the input row. The Type column shows the input type. Clicking the type column for a particular row displays the Input Type menu.

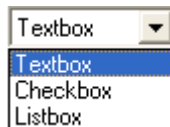

There are three different input types. TextBox is a simple text entry value. CheckBox is an On/Off value and ListBox is a menu that lets the user select from a list of choices. The Initial Value column lets you specify the initial value (TextBox text, CheckBox state and ListBox selection) that is shown when the user input step runs. To create a list for a ListBox, enter the text for the first item then press the Enter key. Repeat these steps for each additional item, and then select the desired item you want as the initial choice. To remove an item from the list, first select the item then press the Delete key. You can also use the Delete key to remove the initial value for a TextBox item.

## 5.7 Report Field

When a test sequence runs, the test report file is updated with the results. Test reports are based on template files created by MS Word. The template file used by the test report window is shown in the design window (top of this page) below the input table next to the report icon. Clicking this icon activates the test report window. Refer to the Test Report topic for more information on creating and selecting test report templates.

If the template file contains form fields, clicking the **Report Field** column in the input table will display a menu that allows you to select the form field to store the information input by the user. Items in red mean that field is **Undefined** in the selected template file. Either the wrong template file is selected or the file was changed and this field no longer exists. To remove a form field for a row, click the report column for that row then press the Delete key.

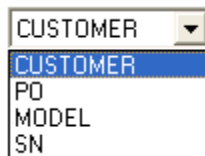

### 5.7.1 Comment

The text you enter in the **Comment** box automatically appears in the step table and test report.



## 5.7.2 User Input Window

When the test sequence runs a user input step, the user input window appears as shown below.

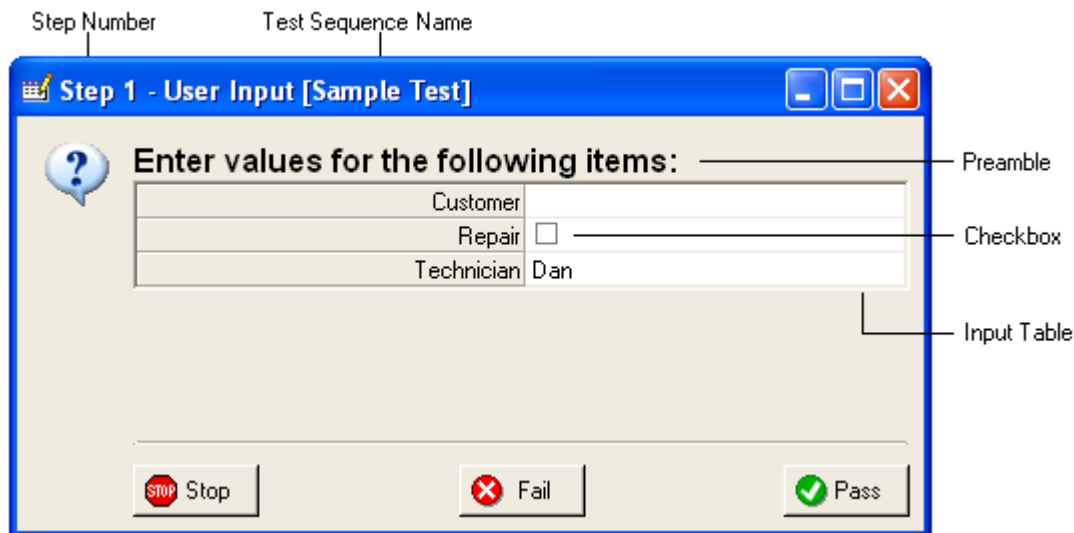

The Preamble and Input Table show the values from the design window. The input table is automatically filled in with initial values (including items and selection for the ListBox) if specified. Clicking a Checkbox toggles the checkbox state. Note that the Report Field column is not shown. This is because the value input by the user is automatically stored in the report field (if any) specified in the design window.

After the user enters the values, pressing the Pass button causes the test sequence to proceed with the next step. Pressing the Fail button stops the test with "Failed" results. Pressing the Stop button (similar to pressing the Stop button in the Run Toolbar) stops the test with "Stopped" results. In all three cases, the values entered by the user are stored in the test report.

The title bar of the window shows the step number and test sequence file name. If the test sequence is part of a test plan, the test plan step number and file name are shown first.

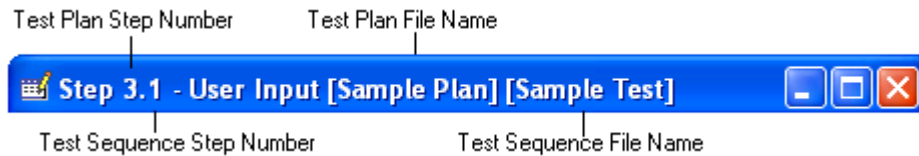

## 5.8 User Prompt

The User Prompt step allows the test sequence to ask the user to perform some task such as verifying UUT operation or changing the test configuration. Shown below is the User Prompt design window.

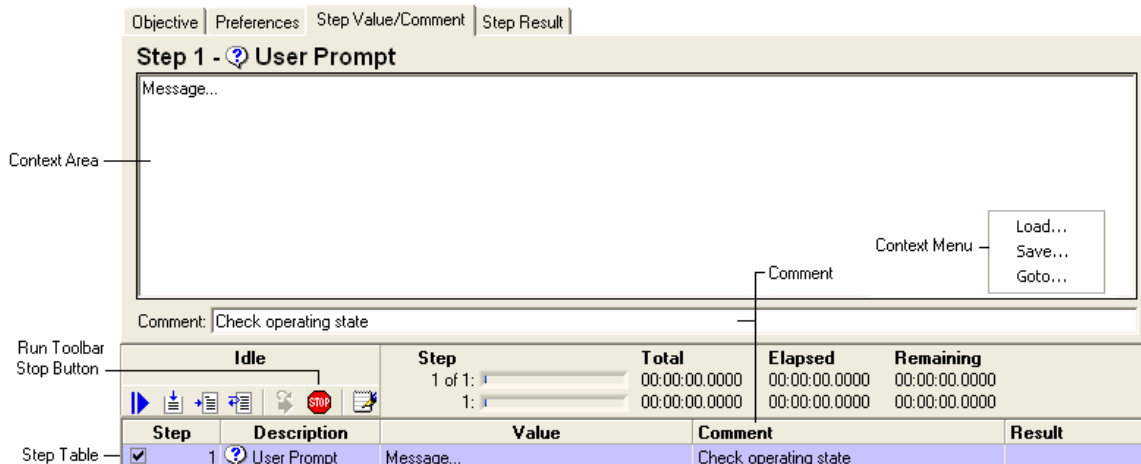

The context area contains the message text displayed to the user when the step runs. You can type directly into the context area or copy and paste text or graphics from another application. Right-clicking the context area displays the Context Menu. You can Load or Save text from a Rich Text (\*.rtf) or Plain Text (\*.txt) file. Go-to... shows the current cursor location and allows you to position the cursor to a particular line and column.

The text you enter in the Comment box automatically appears in the step table and test report.

## 5.8.1 User Prompt Window

When the test sequence runs a user prompt step, the user prompt window appears as shown below.

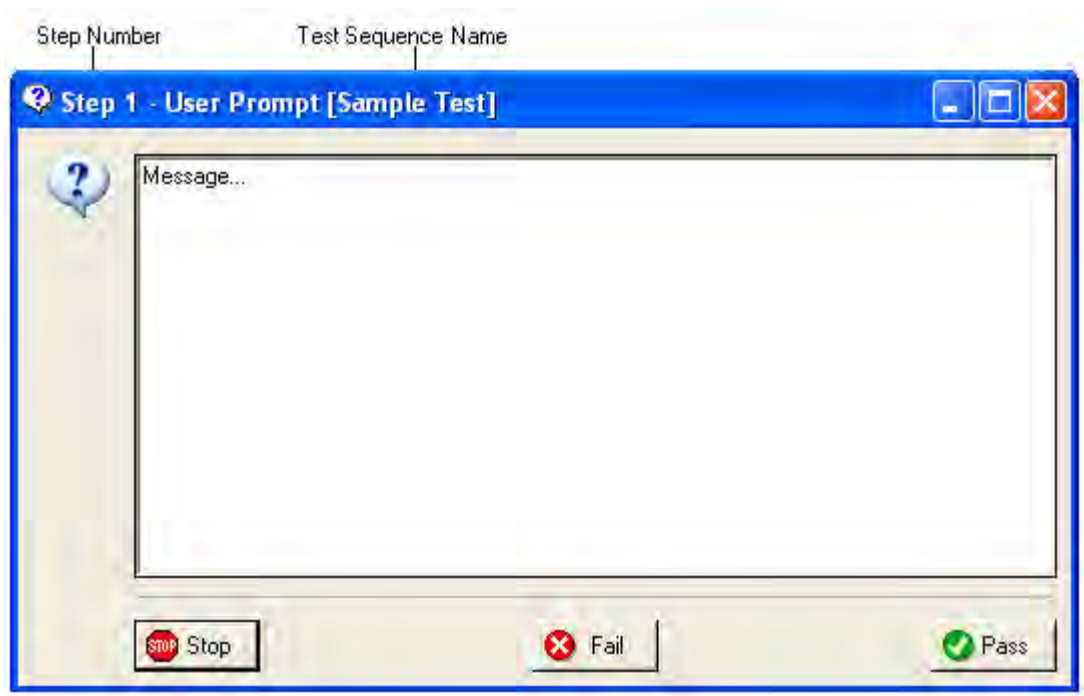

Pressing the **Pass** button causes the test sequence to proceed with the next step. Pressing the **Fail** button stops the test with "Failed" results. Pressing the **Stop** button (similar to pressing the Stop button in the Run Toolbar) stops the test with "Stopped" results.

## 5.9 VISA

The VISA step allows the test sequence to perform generic instrument control and monitoring. It's primarily designed for use with instruments that support message based communication using the SCPI standard. The VISA step design window is shown below.

The screenshot shows the VISA step configuration window. It includes the following components:

- Resource Table:**

Resource	Value
Interface	GPIB
GPIB Board	
Primary Address	1
Secondary Address	
- Read/Write Table:**

Read/Write	Value
Timeout (msec)	5000
Termination Char	10
Send END (Write)	Yes
Suppress END (Read)	No
Command	*IDN?
Response	Read
- Comment:** Get Device ID and Serial Number
- Progress Bar:** Shows 1 of 1 steps completed. Total, Elapsed, and Remaining times are all 00:00:00.0000.
- Step Table:**

Step	Description	Value	Comment	Result
1	VISA	GPIB::1::INSTR *IDN	Get Device ID and Serial Number	

The Resource Table defines the interface settings used to connect to the instrument. The items shown in the resource table vary depending on the interface type you select. Clicking the "Interface" value column displays the Interface Menu.



The Interface menu lets you select from a list of hardware interfaces. You can use Measurement & Automation Explorer (MAX) available from National Instruments to view, test and configure the installed hardware and software interfaces on your PC. Note that some items in the resource table are optional and can be left blank.

The Read/Write Table defines the communication settings to use with the instrument. The "Timeout (msec)" value is the maximum time the VISA step will wait for the instrument to complete the command or provide the response. The "Command" value is the command to send to the instrument. If the instrument command generates a response, choose "Read" for the response otherwise choose "None". The response is shown in the Step Result tab and included in the test report.

The text you enter in the Comment box automatically appears in the step table and test report.

## 5.10 Test Plan Window

Test plans manage and simplify complex tasks by allowing you to link together a series of test sequences into a single test. Test sequences consist of one or more test steps designed to run a test, automate a task, or control and monitor your power source or other instruments. The results of a test sequence and test plan are stored in the test report.

When you open an existing test plan file or create a new one using the Test Manager Button in the UPC Studio window, the test plan window appears as shown below.

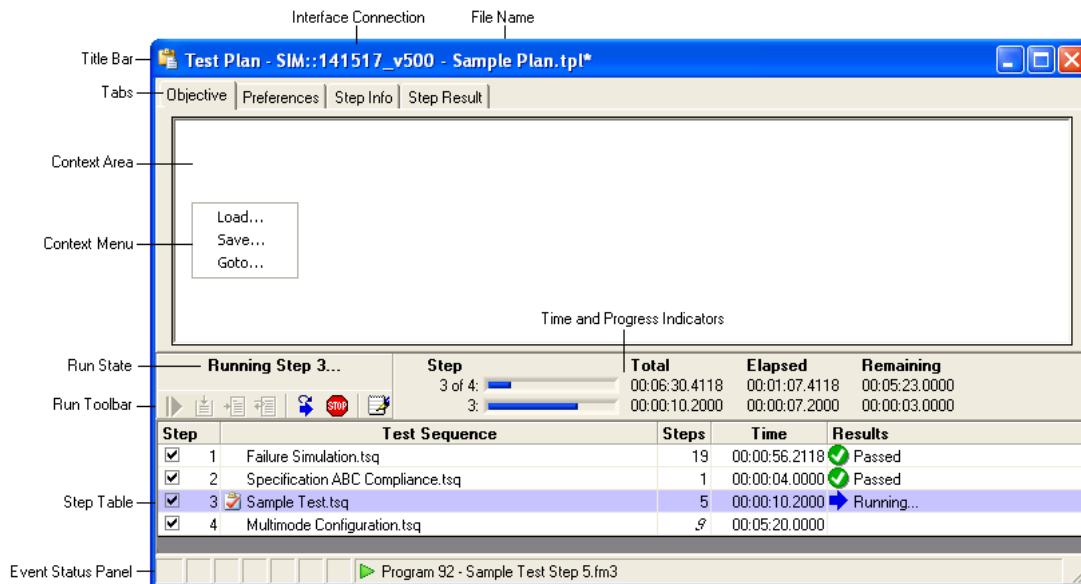

### 5.10.1 Title Bar

The title bar shows the interface used to connect to your UPC and the test plan file name. An "\*" at the end means the file is currently being edited and the changes have not been saved.

### 5.10.2 Objective Tab, Context Area and Context Menu

Selecting one of the tabs updates the **Context Area** with that item. In the above example, the **Objective** tab is selected. The objective is intended as a brief summary or description of the test plan and is automatically included in the test report. You can type directly into the context area or copy and paste text or graphics from another application. Right-clicking the context area displays the **Context Menu**. You can **Load** or **Save** the objective from a Rich Text (\*.rtf) or Plain Text (\*.txt) file. **Go-to...** shows the current cursor location and allows you to position the cursor to a particular line and column.

### 5.10.3 Preferences Tab

The **Preferences** tab shown below, displays general settings and file information for the test plan.

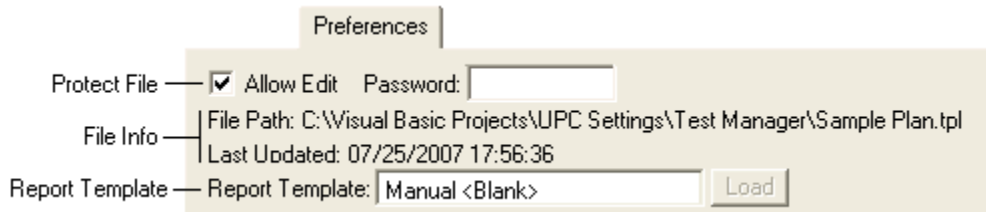

You can protect a test plan from inadvertent changes by un-checking the Allow Edit checkbox. For additional security, you can assign a Password. Once a password is assigned, you will be prompted to enter it in order to allow editing. The File Info section shows the full path of the test plan database file and the last time it was updated.

The Report Template shows which template is used by all test sequences in this test plan. This is useful if the test sequences update form fields in the report or you want the test plan to always use a particular template. If this item is red, that template file is missing from the Templates folder (typically "C:\Pacific Power Source\UPC Manager\Test Reports\Templates"). Pressing the Load button initializes the report with that template (if it's not already loaded). Clicking in the report template text box displays a drop-down list of template files installed on your computer that you can select. The "Manual" selection means the test sequences use whatever template file is currently loaded. An "\*" means the test report has been updated and changes have not yet been saved. Note: The test plan report template overrides the report templates specified in the test sequences.

### 5.10.4 Step Info and Step Result Tabs

These tabs relate to the step selected in the step table. The Step Info tab is shown below.



The Step Info tab shows the full path of the test sequence database file and the last time it was updated. Test plans only contain references to test sequence files, not the actual file contents. Test plans maintain "relative" path relationships with test sequence files. This allows the test plan and test sequence files to be moved to a different location or PC, as long as the files retain the same location relative to each other.

The **Step Result** tab shows the result icon and title (Passed, Failed, Stopped, and Skipped), date/time the step completed and the elapsed time the step completed from the beginning of the test. If a step fails, the results also include the error description.

### 5.10.5 Run State







The Run State section above the Run Toolbar shows the current status of the test. The various run states are shown below.

<b>Idle</b>	No test or steps have completed or are currently running.
<b>Running Step n...</b>	Step "n" is currently running.
<b>Stopped</b>	The test was stopped. The results column in the step table shows which step was stopped. A test is stopped by pressing the Stop button in the run toolbar or the Stop button in a User Prompt, User Input or Transient Prompt dialog box.
<b>Failed</b>	The test failed. The results column in the step table shows which step failed. Click in the results column for that step to view additional information.
<b>Done</b>	The test or selected step(s) have successfully completed.



## 5.10.6 Run Toolbar

The table below describes the buttons in the Run Toolbar. Some items (like **Run Step**) require one or more selected rows in the step table. Running a step runs the entire test sequence for that step. To run an individual step in a test sequence, open the test sequence file (double-click it in the test plan step table), then use the run toolbar in the test sequence window.

-  **Start** - Clears the test report then runs the entire test starting from step 1 (regardless of which step is currently selected).
-  **Continue** - Resumes the test starting with the currently selected row (step). The test continues to the last step.
-  **Run Step**- Runs the selected step(s) then pauses. Run Step is convenient for testing and troubleshooting.
-  **Run To Next**- Runs the selected step. When the step completes, the test pauses with the next row selected. Run To Next allows you to "single step" through a test sequence.
-  **Show Running Step**- When a test is running, pressing this button selects and shows the currently running step, scrolling the step table if necessary.
-  **Stop** - Stops the test and disables the power source output.
-  **Show Report** - Shows the test report window

Running a test using **Start** first initializes the test report then appends the test data to the report after each step completes. This creates a clean test report each time the test is run. Running a test using the other controls does not first clear the test report, making it easier to troubleshoot (single step etc) a test.

## 5.10.7 Time and Progress Indicators

The upper time and progress indicator shows the values for the entire test (all enabled steps) and the lower one shows the values of the selected step(s). The total time values update as step rows are selected making it easy to see when that step begins relative to the start of the test, even if a test is not running. The total time values take into account if step rows are not enabled (step checkbox not checked). Time and progress indicators are updated as the test runs. Step times are estimates based on the test sequence and system performance. Time

values are shown in HH:MM: SS.SSSS format. The actual elapsed time of each step is recorded in the test report.

### 5.10.8 Step Table

Refer to the Step Table topic for more information.

### 5.10.9 Event Status Panel

Refer to the Event Status Panel section for more information on these items.

### 5.10.10 File Menu and Toolbar

The file menu and MDI toolbar (shown below) allow you to create a **New** test plan, **Open** an existing file, **Save** or **Save As...** (To a different file) or **Revert** the test plan to the last saved version. The Save and Revert items are only enabled if the test plan has been edited but not yet saved (the file name in the title bar shows an "\*" at the end).

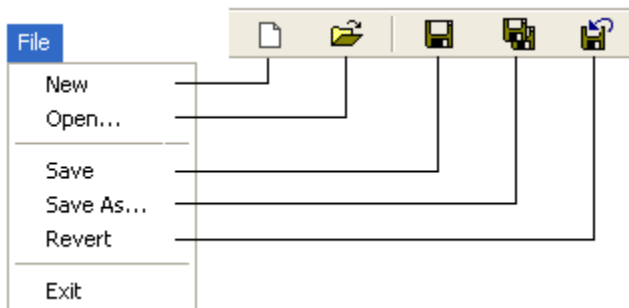

## 5.11 Test Plan Step Table

The step table shown below appears at the bottom of the Test Plan window. The steps in the table are links to test sequence files stored in the Test Manager folder (Typically "C:\Pacific Power Source\UPC Manager\Test Manager"). Double-clicking one of the test sequence files in the table opens the test sequence window, allowing you to view or edit the values.

Step	Test Sequence	Steps	Time	Results
<input checked="" type="checkbox"/>	1 Failure Simulation.tsq	19	00:00:56.2118	
<input checked="" type="checkbox"/>	2 Specification ABC Compliance.tsq	1	00:00:04.0000	
<input checked="" type="checkbox"/>	3  Sample Test.tsq	5	00:00:10.2000	
<input checked="" type="checkbox"/>	4 Multimode Configuration.tsq	9	00:05:20.0000	

File Status Icon

### 5.11.1 Adding or Removing Steps

If you right-click in the step table, the step context menu appears as shown below.

Add...	
Cut	Ctrl+X
Copy	Ctrl+C
Paste	Ctrl+V
Delete	DEL
Select All	Ctrl+A
<hr/>	
Clear Results	

The menu items apply to the currently selected step(s). New steps are added or pasted after the selected step. To add a step at the beginning, first click the table header. To add a step at the end, first select the last step or click the blank area at the bottom of the table. The items in the step context menu are described below.

<b>Add</b>	Displays a file open dialog box. The test sequence file you select is added to the table.
<b>Cut</b>	Copies the selected steps to the clipboard and then deletes them from the table.
<b>Copy</b>	Copies the selected steps to the clipboard.
<b>Paste</b>	Pastes the clipboard after the selected step.
<b>Delete</b>	Deletes selected steps.
<b>Select All</b>	Selects all steps.
<b>Clear Results</b>	Clears the results column of the selected steps.





### 5.11.2 Step Table Columns

The columns in the step table are described below.

<b>Step</b>	Step enable checkbox and step number. Steps that aren't checked are skipped when the test sequence runs. Un-checking a step is a convenient way to temporarily disable a step while troubleshooting or reconfiguring a test.
<b>Test Sequence</b>	Shows the File Status Icon and test sequence file name. Refer to the test sequence file status section below for more information.
<b>Steps</b>	The total number of steps in the test sequence. Numbers in <i>italic</i> mean the test sequence contains one or more disabled steps.
<b>Time</b>	The time estimate to run the test sequence.
<b>Result</b>	Shows the results state (Pass, Fail, Stopped, and Skipped) the last time this step was run. It also shows if a step is currently running. Clicking in the results column for a particular step automatically selects the Step Result tab in the test plan window, providing additional information.

### 5.11.3 Test Sequence File Status

The test sequence file status is shown in the **Test Sequence** column of the step table. The table below shows the status of various conditions.

Sample Test.tsq	The test sequence file exists but is currently not loaded.
 Sample Test.tsq	The test sequence file is currently loaded. Test sequence files are automatically loaded when they are run or opened (double-click).
 Sample Test.tsq*	The test sequence file is loaded and currently being edited (*).
 Sample Test.tsq	The test sequence file is missing. Use the <b>Step Info</b> tab in the main test plan window to view the file path the test plan expects.
 Sample Test.tsq	The test sequence contains invalid values or values not supported by your power source. Double-click the file to view or edit the values (opens test sequence window). Note that the test plan only checks for invalid or unsupported values when the test sequence loads or runs.

## 5.12 Test Report

The Test Report window allows you to view and print test reports created by a test sequence or test plan. To access the test report window, click the **Report icon** in the **Run Toolbar** in the Test Plan or Test Sequence window.

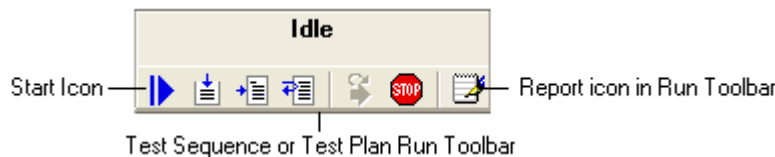

### 5.12.1 Toolbar and File Menu

The top of the test report window includes a File menu and toolbar as shown below.

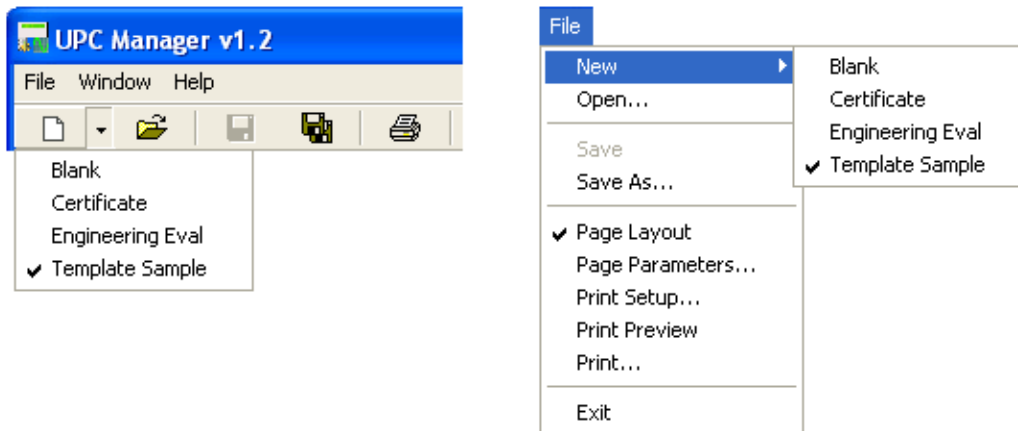

The New item allows you select one of the template files stored in the Test Report template folder (typically "C:\Pacific Power Source\UPC Manager\Test Reports\Templates"). You can use MS Word to create RTF files to use as test report templates. Template files can be blank or contain introductory text, graphics, form fields, page/paragraph/character formatting, page header and footer (page numbering, date etc). Selecting a new template file or pressing the New button creates a new test report based on that template file. The form field names you assign in MS Word (field bookmark) are the form fields that are available to the User Input step.

A sample test report initialized from a template file is shown below.

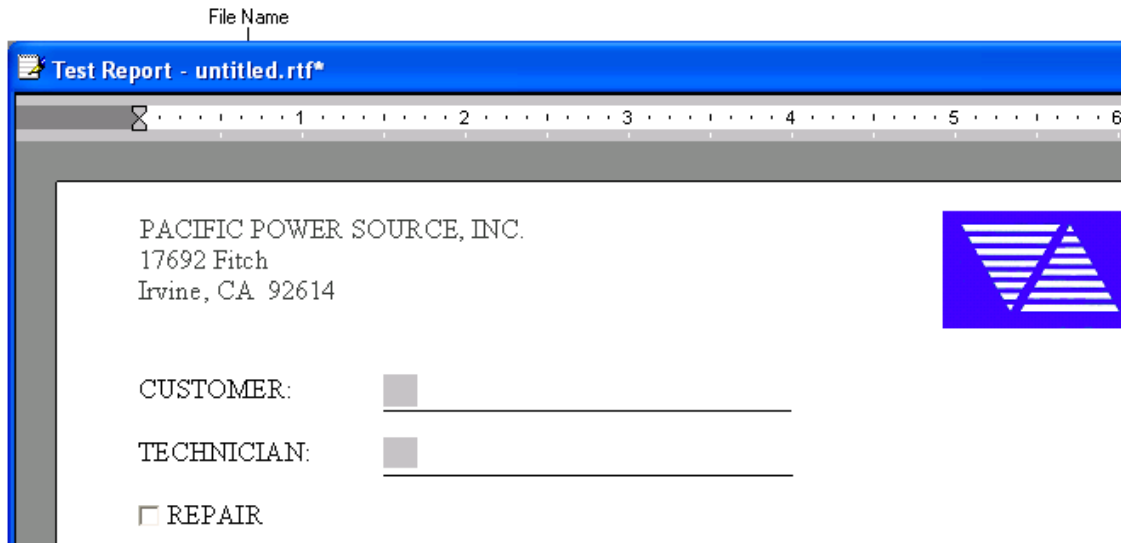

The Open item in the File menu and toolbar allows you to open an existing test report to view or print. The Page Layout and Print items allow you to configure the page properties for view and printing. The Save item is enabled after the test has run allowing you to save it to a file. Save As is used to save a new test report for the first time or save an existing report to a different file.

## 5.13 Test Results

Running a test sequence or test plan appends the results of each step at the end of test report. Running a test sequence from the beginning (using the **Start icon** in the **Run Toolbar**) initializes the test report from the selected template file then adds the test sequence Objective and Preferences. This creates a clean report each time the test sequence is run. Running a test sequence using the other controls does not clear the test report or add the Objective or Preferences, making it easier to troubleshoot (single step etc) a test.

After each step runs, the information about that step is appended to the test report as shown below. This information includes the **Title**, **Value**, **Comment**, **Result** and **Data** of each step.

Title	<input checked="" type="checkbox"/> <b>Step 2 - Meter [Sample Test]</b>	Type: V, I, F, Power	Form: 3	If Outside Limits: Fail	Samples: 1	Interval: 1.0 sec
Value	Phase A	Vrms	Yes	Yes		
			< 120.500	<= 25.000		
	Phase B		> 119.500			
		Vrms	Yes	Yes		
	Phase C		< 120.500	<= 25.000		
			> 119.500			
Comment	<b>Comment:</b> Check Volts and Amps					
Result	<input checked="" type="checkbox"/> <b>Passed - 07/25/2007 14:51:18 [Elapsed Time HH:MM:SS = 00:00:01.9414]</b>					
Data	Phase	Vrms(L-N)	Irms			
	A	120.000	0.000			
	B	120.000	0.000			
	C	120.000	0.000			

Title includes the enable checkbox, step number, icon, type and test sequence file name. Value and Comment are the test sequence information from the Step Value/Comment tab (design window). Result shows the result icon, title, date/time the step completed and the elapsed time the step completed from the beginning of the test. Note that not all steps produce data. The data also includes any errors that occurred running the step. Result and Data are also shown in the Step Result tab in the test sequence window.

### 5.13.1 Test Plan Step Title

When a test sequence is part of a test plan, the step **Title** in the test report shows both the test plan and test sequence step numbers and file names.

Test Plan Step Number	Test Plan File Name
<input checked="" type="checkbox"/> <b>Step 1.2 - Meter [Sample Plan] [Sample Test]</b>	
Test Sequence Step Number	Test Sequence File Name

### 5.14 Controlling Report Information

A Script can use the TM.StepReportFlags method to control the information added to the test report for any step. The default setting is to include all information (Title, Value, Comment, Result and Data)

## 6 Introducing UPC Control

The UPC Control window allows you to directly control your UPC through the remote interface. In addition, you can monitor the status of your power source and view metered values like output voltage, load current, waveforms and harmonics. UPC Studio also allows you to access all items in the UPC Control window.

**\*\*CAUTION\*\***

Because UPC Control allows you to make immediate changes to your power source, you should carefully consider the effects changing a particular setting (e.g. output voltage) may have. To minimize problems, you should instead use UPC Studio to control your UPC. UPC Studio provides many safeguards and guides you into entering values that are appropriate for your power source.

Use the UPC Control Connection Setup window to connect to your UPC.

### 6.1 UPC Control Connection Setup

Before UPC Control can communicate with your UPC, you must specify the interface connection. The steps below describe how to connect to your UPC.

1. Press the **UPC Control** icon in the toolbar
2. The **UPC Control Setup** window appears as shown below. In this example, the **GPIB** interface tab was selected. Click on the tab corresponding to the interface connection of your UPC then enter the appropriate communication settings. You can view or change the remote interface settings currently programmed in your UPC by pressing **FN 3, 3** on the UPC front panel.
3. Specify the cache file that will be created when controlling your UPC. The default cache file name automatically assigned for you should be fine for most applications.
4. After you specify the appropriate connection settings, press the **Connect** button.



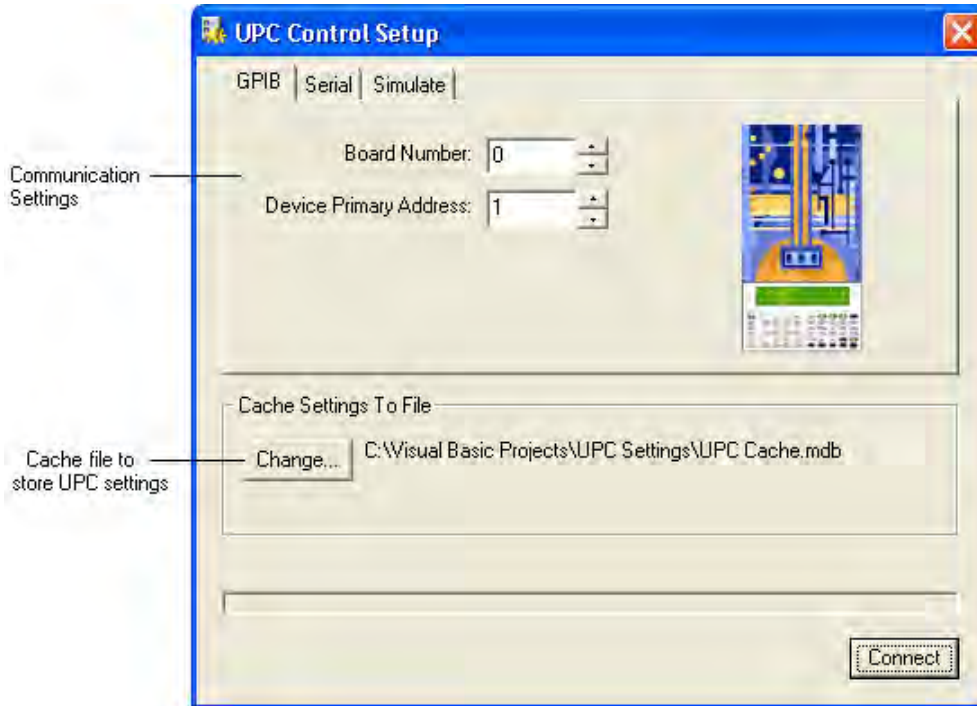

The progress of connecting is shown in the window. When the connection process completes, the UPC Control window appears. Also a UPC Meter window appears that allows you to view all UPC measured values.

## 6.2 Simulation Mode

In addition to being able to connect to your UPC using either a GPIB or Serial interface, you can connect to a virtual UPC using a simulation file. Simulation files are nothing more than UPC Settings files and can be created using the Read UPC Settings icon in the toolbar. Simulation files should be stored in the "Simulate" folder located in the same directory as the UPC Manager application (typically "C:\Pacific Power Source\UPC Manager\Simulate").

Simulation files are handy if you want to run your UPC "off-line". You can then upload your changes to your UPC using the Write UPC Settings icon in the toolbar. Shown below is an example of the UPC Control Setup window with the Simulate tab selected.

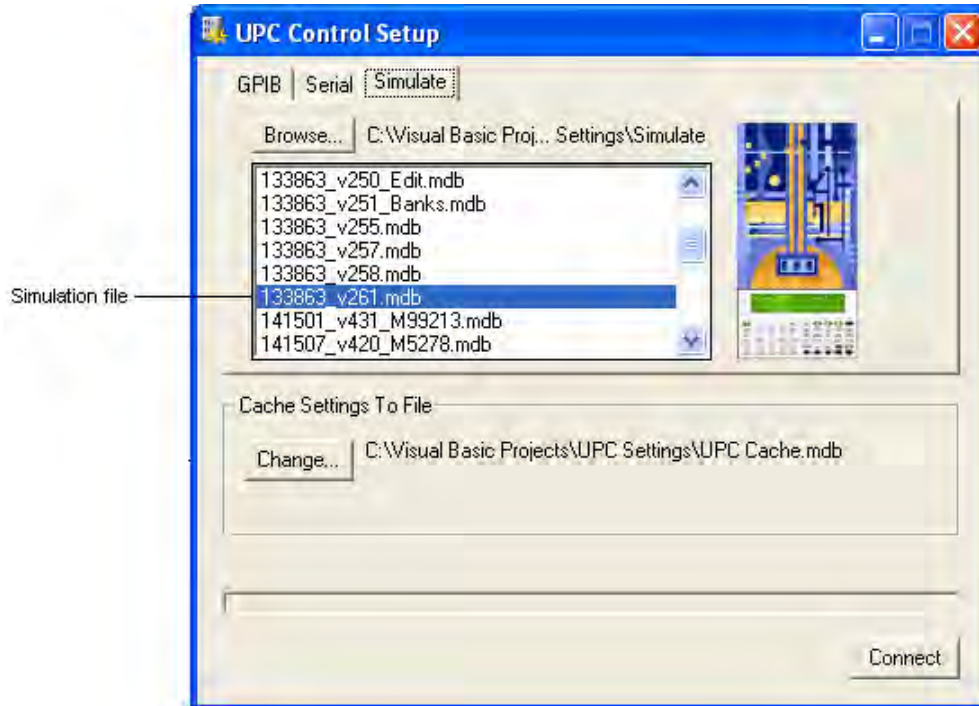

## 6.3 UPC Control Window

After you connect to your UPC using the UPC Control Setup window, the title bar of the window shows the interface connection and the cache file name you specified. The UPC Control window is similar to the View/Edit UPC Settings window except changes you make immediately take affect. Another difference is there is now a Control and Event Panel at the bottom of the window. A series of **tabs** at the top of the window displays panels related to various UPC settings.

### 6.3.1 Operation

The **UPC Control** window automatically sends values as you update them, then immediately queries them to verify. Initially after connecting to your UPC, none of the programs, waveforms or setup values is read. When you first select a panel (or item), the UPC Control window notes that this view has not been queried, so it sends the necessary commands to your UPC to read the values. These values are then stored in the **cache file** specified in the Connection Setup window. The cache file minimizes the communication activity with your UPC, increasing the navigation

speed of the views. The **UPC Control** window uses the stored values in the cache file to display the items in the various panels. You can manually update the cache file by pressing the **Refresh** button located in the control panel at the bottom right of the window. This forces fresh values to be read from your UPC. This normally isn't necessary unless you change a value using the UPC front panel, causing UPC Control to get out of sync.

### 6.3.2 Info Panel

The **Info panel** is the initial tab selected after you connect to your UPC. The Info panel shows basic information and capabilities about your UPC. Some of the items like "ProgZo", "Execute Phase" and "Current Protect" are related to a particular firmware MOD or assembly. Firmware MODs are customer specific options that are installed at the factory. Some features are not supported by older firmware versions and are shown in **red**. Refer to the Firmware Versions section for information about features not supported by older firmware.

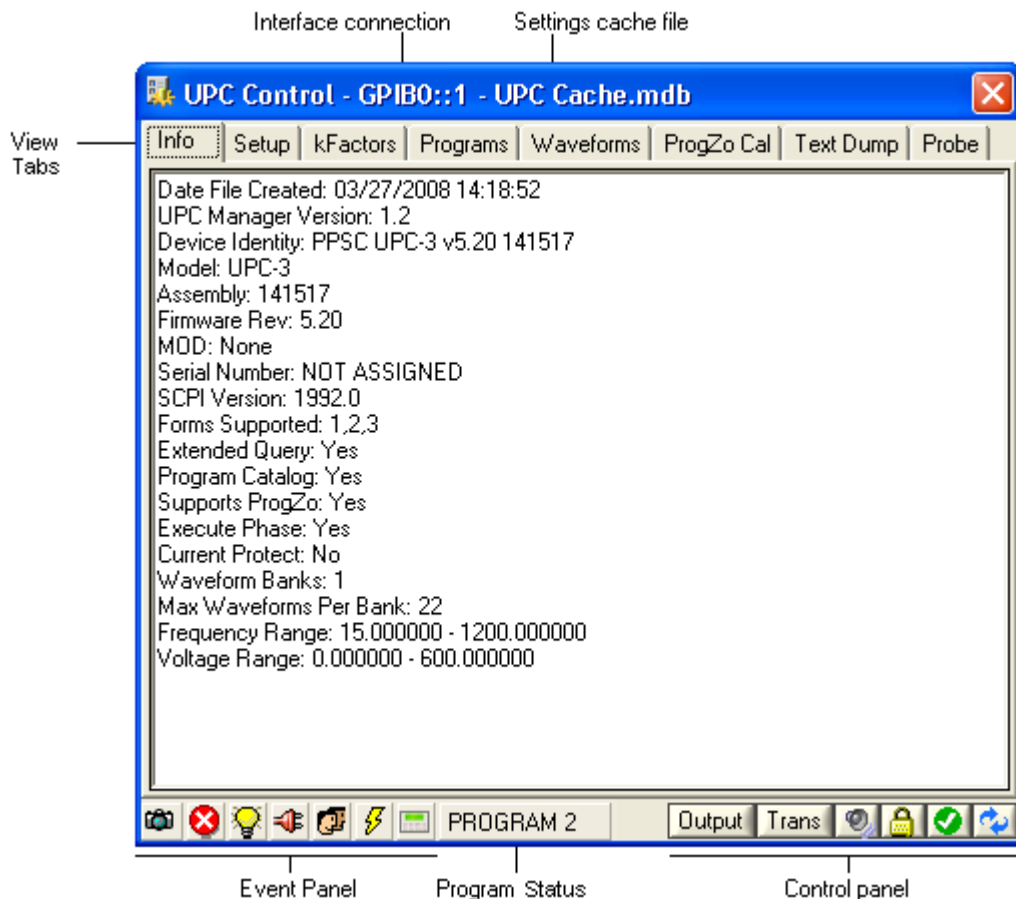

Refer to the Control and Event Panels section for more information on these items.

### 6.3.3 Setup Panel

The window below shows the UPC Control window with the Setup tab selected. If certain items are grayed, it means your UPC does not support that feature. Items shown in red indicate the firmware in your UPC does not support querying that value. Refer to the Firmware Versions section for information about the defaults UPC Manager Substitutes for these values.

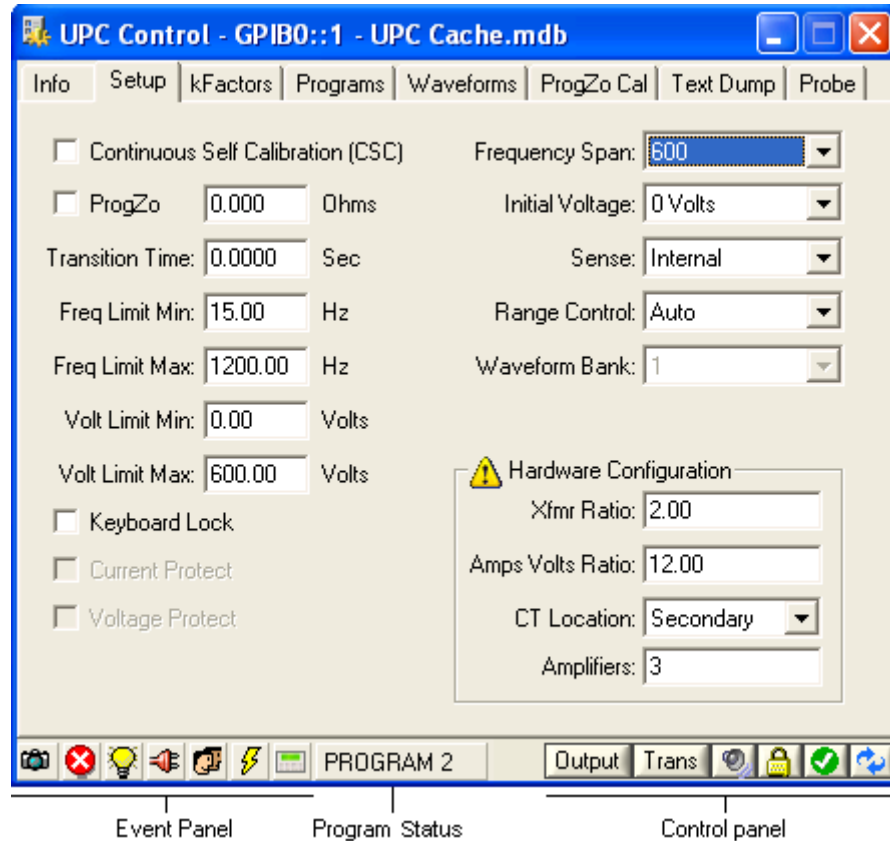

Refer to the Control and Event Panels section for more information on these items.

### 6.3.4 kFactors Panel

The window below shows the UPC Control window with the kFactors tab selected. kFactors are the calibration values stored in your UPC that affect voltage and current sensing accuracy used for metering. The items shown in this panel vary depending on the UPC model. In the example below, UPC-1/3 has separate kFactor columns for each Form. In order to enable entering kFactors for a particular Form, you must first change the Manual Mode program (in the Programs panel) to that Form.

**WARNING: Changing these values will affect the accuracy of your power source and may damage the load. Refer to the UPC User's Manual for information on calibrating your UPC.**

The screenshot shows the 'UPC Control - GPIB0::1 - UPC Cache.mdb' window. The 'kFactors' tab is active, displaying a table with the following data:

Name	Form 1	Form 2	Form 3
Vint A	1.059862	1.000000	1.001455
Vint B	NaN	NaN	1.002349
Vint C	NaN	NaN	1.001987
Vext A	1.052249	1.000000	1.003245
Vext B	NaN	NaN	1.008954
Vext C	NaN	NaN	0.998970
I A	0.997823	1.000000	1.006887
I B	NaN	NaN	1.005687
I C	NaN	NaN	1.003987
Vosc A	0.991023	1.000000	0.998000
Vosc B	NaN	NaN	0.956000
Vosc C	NaN	NaN	1.000321

The interface also includes a menu bar (Info, Setup, kFactors, Programs, Waveforms, ProgZo Cal, Text Dump, Probe), a toolbar with icons for Event Panel, Program Status, and Control panel, and a status bar showing 'PROGRAM 2' and 'Output Trans'.

Refer to the Control (7.1) and Event (7.2) Panels section for more information on these items.

### 6.3.5 Programs Panel

The Programs panel in the UPC Control window allows you to view or change any program stored in your UPC including the Manual Mode values. Select one of the programs in the list to view the steady state and transient values. If a particular program is not stored, the steady state and transient items do not appear when that program is selected. Stored programs are typically shown in black text and gray text means no program is stored at that location. With older versions the firmware, UPC Control cannot determine in advance which programs are stored until you select it. Clicking the **Execute** button executes the selected program.

You can right-click a program in the list to display the **Program Context Menu**. This menu allows you to create or delete a program, import or

export a program from a file, print text values of the program to your printer or add a transient.

When you right-click a transient segment, the program context menu also allows you to delete the selected segment or add a new one. The transient button in the Control panel at the bottom right of the window will trigger the transient. Note that you must first execute a program before triggering its transient. Also, the Manual Mode program cannot contain a transient.

The **Link/Unlink** icon is available for certain columns in the tables. This allows you to set the values for all phases independently or as a group. To change **Link/Unlink**, click in the column header. You can also selectively link items using the row checkboxes.

The **Program Preview** button is described in the Program Preview section.

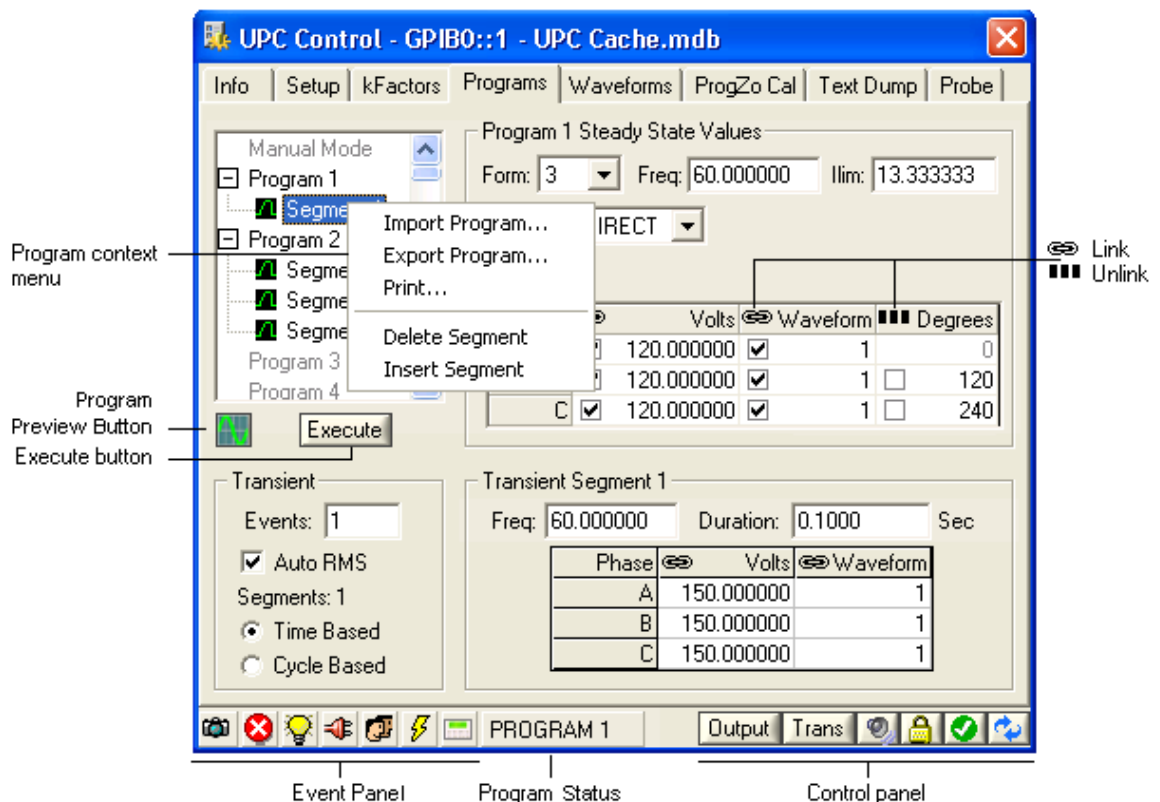

Refer to the Control (7.1) and Event (7.2) Panels section for more information on these items.

### 6.3.6 Waveforms Panel

This Waveforms panel in the UPC Control window allows you to view or change waveforms in your UPC. The thumbnail buttons on the left of the window select which waveform is displayed. If you right-click a button, a menu appears that allows you to import or export that waveform from a file or print the waveform. Note that the selected waveform is overwritten when you import a waveform. Also, waveform 1 (sine wave) is reserved so you cannot **Import** it.

If you right-click on the waveform graph, a menu appears that allows you to select the cursor and pan or zoom options. When **Cursor** is checked, a vertical line appears in the graph that tracks the mouse movement with annotation text showing the phase angle (degrees) and amplitude in percent.

The pan and zoom options control the mouse behavior when you click and drag the mouse over the waveform. The **Default** item restores the **Pan** and **Zoom** state to their normal values (100%, centered).



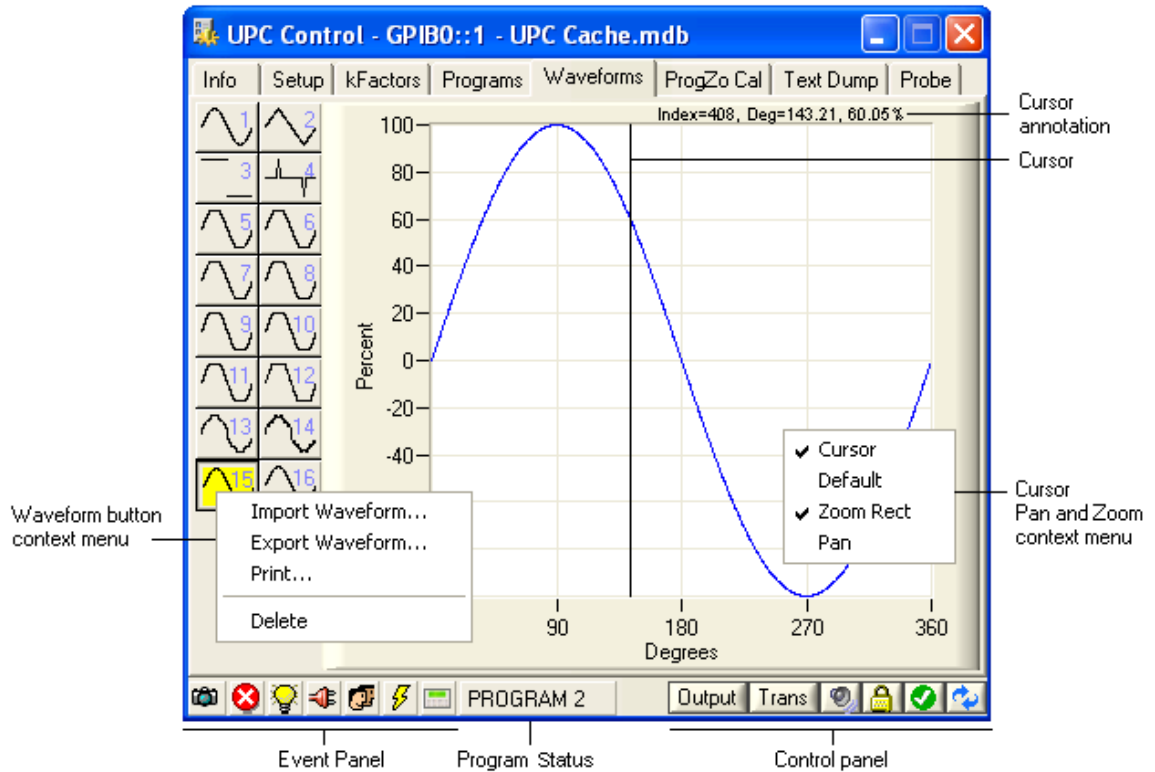

Refer to the Control (7.1) and Event (7.2) Panels section for more information on these items.

### 6.3.7 Prog-Zo Cal Panel

This panel is only available if your UPC is equipped with the programmable output impedance option. This option is installed at the factory. The window below shows the UPC Control window with the Prog-Zo Cal panel selected.

These calibration values "null" the output impedance of your power source to 0 ohms for various output Forms and coupling and affect the output voltage accuracy of your power source. They also allow you to compensate for the cable impedance used to connect the power source to the load. Items shown in red indicate the firmware in your UPC does not support querying that value. Refer to the Firmware Versions section for information about the defaults UPC Manager Substitutes for these values.

**WARNING: Changing these values will affect the accuracy of your power source and may damage the load. Refer to the UPC User's Manual for information on calibrating your UPC.**

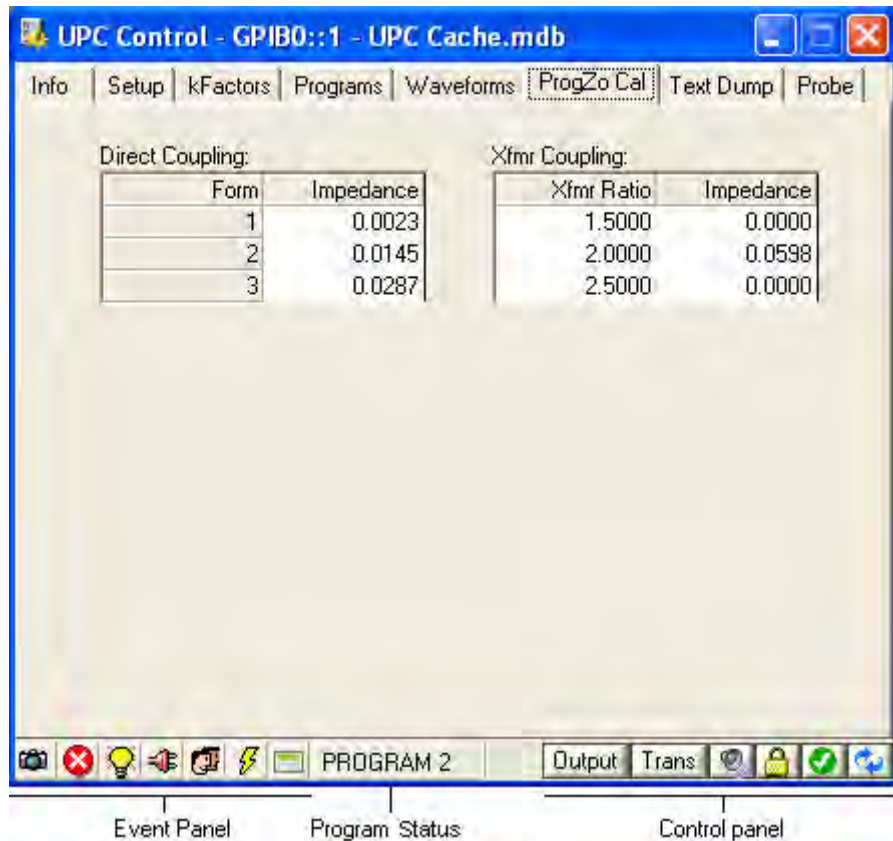

Refer to the Control (7.1) and Event (7.2) Panels section for more information on these items.

### 6.3.8 Text Dump Panel

The file format of the UPC Control cache file is Microsoft Access Database (\*.mdb). The Text Dump panel allows you to view the entire contents of the cache file in text format. Since you are viewing the contents of the cache file, only those items that have been refreshed will be shown.

The **Save** icon in the toolbar allows you to save the cache file to a text file (\*.rtf). You can then open it in a word processor. Use the **Print** icon in the toolbar to print the contents of the Text Dump panel.

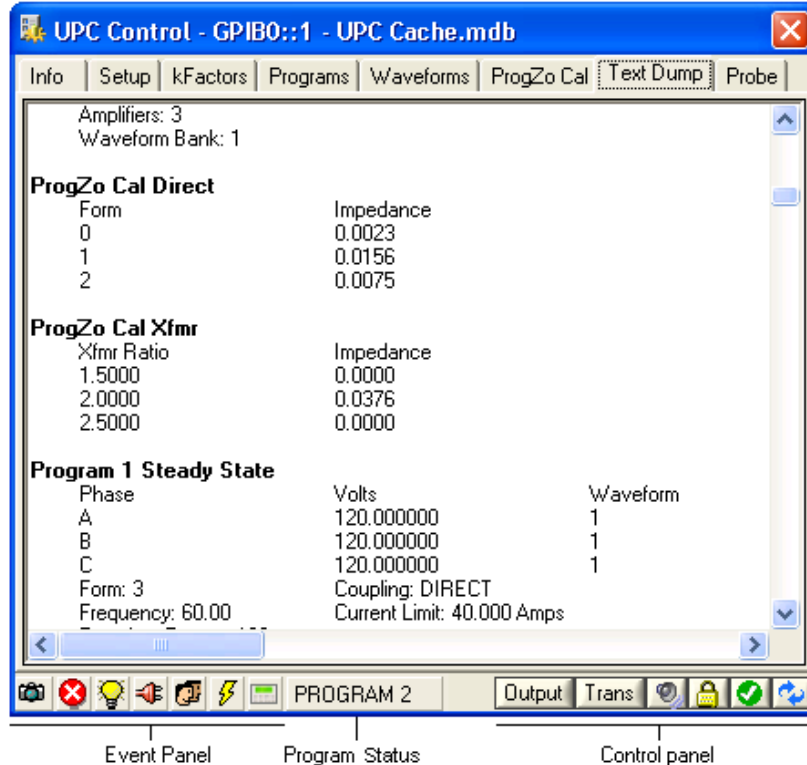

Refer to the Control (7.1) and Event (7.2) Panels section for more information on these items.

### 6.3.9 Probe and Capture Panel

The **Probe** tab in the UPC Control window allows you to send commands and queries to your UPC. To probe your UPC:

1. Click on the **Probe** tab in the UPC Control window.
2. The **Probe panel** appears as shown below.
3. Select an existing command or query from the **Command/Query Strings** drop-down control. You can add a new item to the list by typing in the string and pressing <Enter>. To remove a string, select that item the press the <Delete> key. Refer to the UPC Operation Manual for a complete list of all commands and queries.
4. Once you have selected or entered the desired command or query string, press the **Command** or **Query** button. Make sure you press the correct button based on whether the string is a command or query otherwise you will get an error (most likely a timeout).

- The results of a query are saved in **Received String**. The elapsed time the command or query took is also shown.

## Command/Query Capture

You can also use the Probe panel to capture commands and queries sent by UPC Manager as you activate the various controls and buttons in the other panels (like **Programs** or **Setup**). Simply click the **Capture Control** to activate capturing. A small capture icon appears in the lower left of the event panel. You can then select other panels to access controls and enter values. These commands and queries are saved in the Probe panel and are stored in the **Capture Results** section. The **Red** text is the command/query and the **Blue** text is the response.

## Results Context Menu

When you right-click on the Query or Capture Results, a menu appears allowing you to clear the results or save it to a text file.

## Import/Export Context Menu

When you right-click on "Send String:" an Import/Export menu appears. Use this to load or store the command query strings to or from a file.

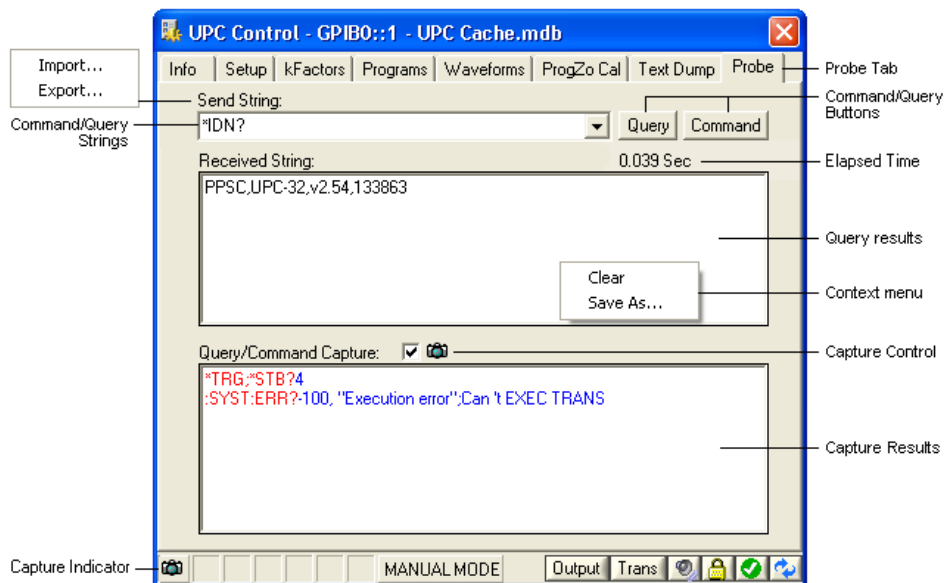

## 7 Control and Event Panels

The Control and Event panels are located at the bottom of the UPC Control window as shown below:

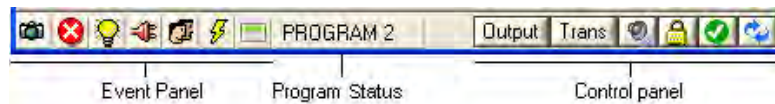



### 7.1 Control Panel

The **Control Panel** is at the bottom right of the UPC Control window. The purpose of each button is described below:

 This shows that the output power is OFF. Pressing this button turns the output power ON.

 This shows that the output power is ON. Pressing this button turns the output power OFF.

 This shows that the steady state program values are executing. Pressing this button triggers the transient portion of the program currently executing. If the program does not contain a transient, pressing this button will cause an error.

 This shows a transient is executing. Pressing this button stops the transient and resumes steady state operation.

 This shows a Ramp is executing. Pressing this button stops the Ramp and resumes steady state operation.

 Pressing this button beeps the built-in UPC speaker.

 This shows that **Local Lockout** is in **Lockout** mode. This prevents you from using the UPC keyboard or viewing V/I meter data on the LCD. Pressing this button changes the state to **Local** mode as described below.

 This shows that **Local Lockout** is in **Local** mode. This allows you to use the UPC keyboard and LCD. Note that if you change values using the UPC keyboard, you should refresh the view in the UPC Control window that contains that setting. Pressing this button changes the state to **Lockout** mode as described above.

 Pressing this button queries your UPC and updates the event panel status and state of the buttons in the Control panel.

 Pressing this button queries your UPC and refreshes the items in the current panel. If the current panel is **Programs** or **Waveforms**, then the selected program or waveform is queried and the view updated.

## 7.2 Event Panel

The **Event Panel** is at the bottom left of the UPC Control window. Except for the **Capture** icon, these icons are normally updated as you change settings or after you execute a program or you press the **Status** button in the Control panel. Later versions of UPC firmware poll the status of your UPC and automatically update these icons. These icons indicate a particular event occurred and they remain latched until you clear them by clicking on that icon.



This icon means that Command/Query capture mode is on. Click this icon or press the "Probe" tab to view the commands and queries that have been sent to the UPC or to turn Capture mode off.



This icon means an error occurred. A message box also appears describing the error. This event is automatically cleared when you close the message box.



This icon means a power-on event has occurred with your UPC. You should normally disconnect (close) UPC Manager first before turning on/off you UPC. This event can alert you that one or more settings may have been changed and that you should refresh the affected views.



This icon means the power source has shut down due to an output overload condition.



This icon means the UPC was operating in the **Local** mode and someone pressed the Local/Remote key on the UPC front panel. This event can alert you that one or more settings may have been changed and that you should refresh the affected views.



This icon means the UPC output was turned off because the output current or voltage exceeded the programmed threshold.



This icon means the remote interface is unavailable because your UPC is not in the V/I Display mode. Press the "Clear" or "Display" buttons on your UPC keyboard to return to the V/I Display screen.



This icon means the remote interface is not responding. This can be because your UPC is turned off or the interface cable is disconnected.

## 7.3 Program Status

The currently executing program is shown at the bottom of the window. This information is normally updated after you execute a program in the Programs panel.

**Note:** Program status is not supported by older versions of the firmware.

## 8 Printing

Once you connect to your UPC, you can press the **Print** icon in the toolbar to print the contents of the UPC Control window. The entire contents of the cache file will be printed including graphs for the waveforms. Since you are printing the contents of the cache file, only those items that have been refreshed will be printed. The Programs and Waveforms panels also allow you to print a selected program or waveform.

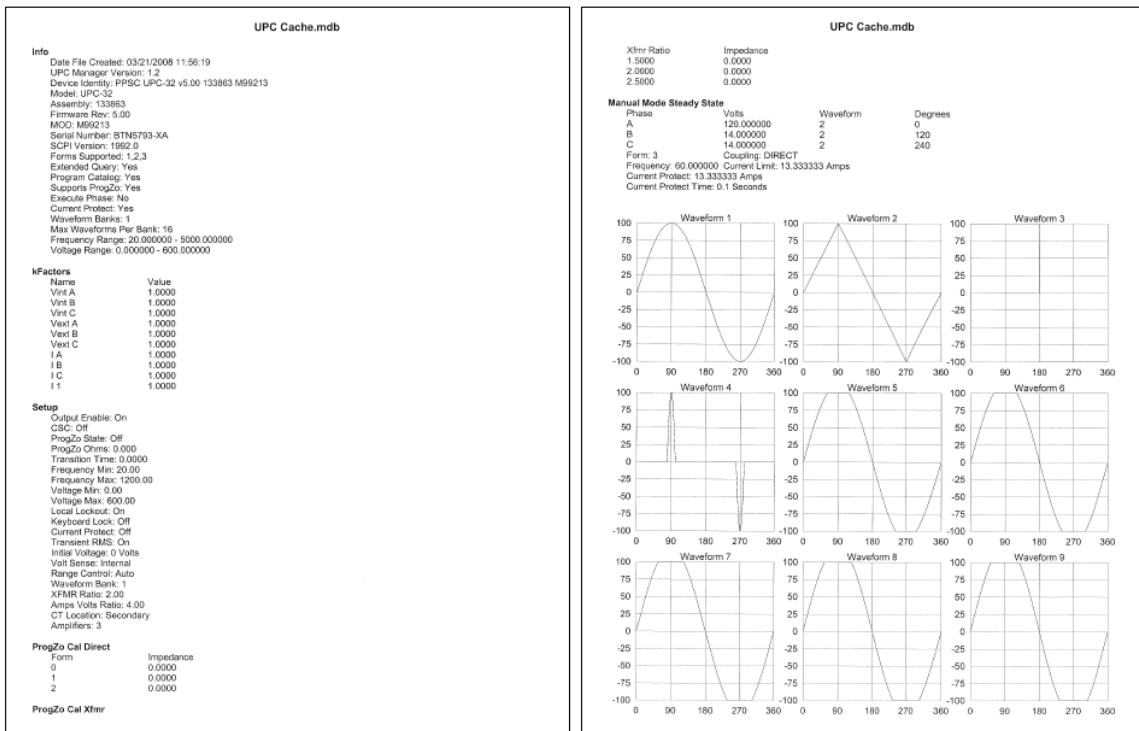

## 9 Saving

The file format of the UPC Control cache file is Microsoft Access Database (\*.mdb). The **Save** icon in the toolbar allows you to save the cache file to a text file (\*.rtf). You can then open it in a word processor. The Programs and Waveforms panels also allow you to save (export) a selected program or waveform.

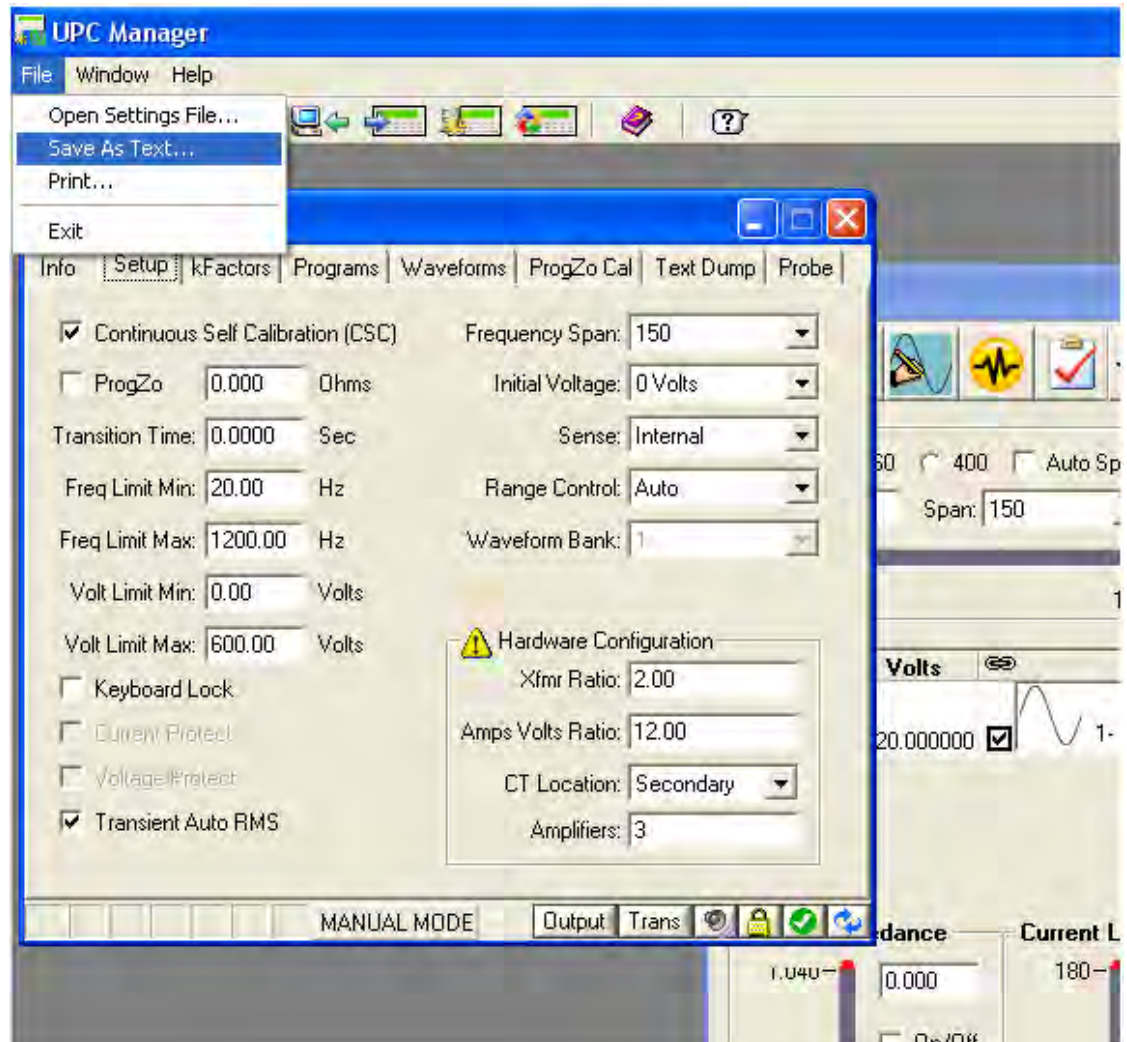



## 10 Program Preview

The **Program Preview** window allows you to view a simulation of the actual waveforms generated by your UPC. To preview a program:

1. Open a setting file or connect to your UPC using UPC Control or UPC Studio.
2. Click on the Programs panel to view the available programs then select the program you want to view. For UPC Studio, open an output sequence or program in the Output Sequence Browser.
3. Press the **Program Preview** button . For UPC Studio, click the **Details** button in the Output Sequence window.
4. The **Program Preview** window will appear as shown below:

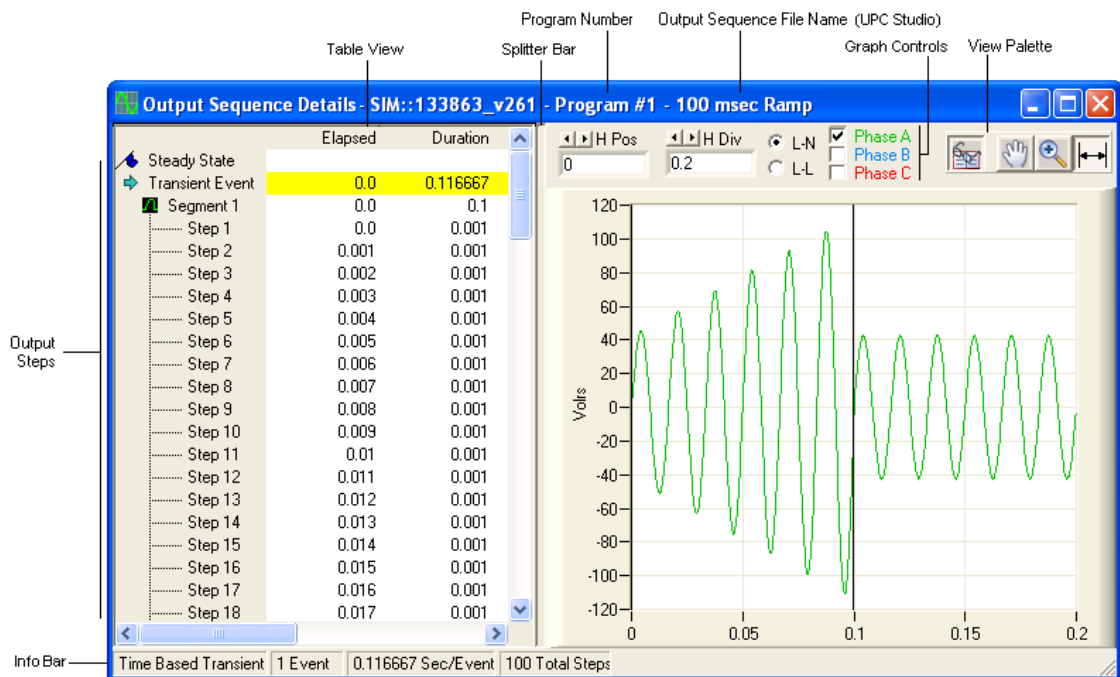

## 10.1 View Palette



This button turns the Table View On or Off



When this button is depressed, the graph pans horizontally when you click and drag the mouse in the graph view.



When this button is depressed, the graph zooms-in horizontally (magnifies) when you click in the graph view. If you press and hold the shift key, the graph zooms-out (reduces) when you click the mouse in the graph view.



When this button is depressed, the cursors are positioned to that step or segment. The corresponding row in the table view is also highlighted.

## 10.2 Splitter Bar

The Splitter Bar allows you to adjust the relative sizes of the table and graph views. To use the Splitter Bar, position the mouse anywhere on the bar and click and drag the bar to the desired position. The splitter bar is not available if the table view is turned off.

## 10.3 Table View

The table view is displayed when the Table View icon is pressed in the View Palette. The left half of the window shows a table containing the items related to that program. The table columns show the elapsed time (running time), the duration of that item, and the output waveform frequency and voltage.

### Steady State

The Steady State program values in the table are always shown in the first row of the table view. Steady state values always begin and end with the Phase A positive zero crossing. If the program does not contain a transient then the next row again shows the steady state values. This provides a cursor reference point in the graph at the Phase A zero crossing.

### Transient Event

If the program contains a transient, then the next row in the table summarizes a single transient event. Note that programs can contain an infinite number of transient events. Since multiple transient events are

simply repeats, only the first event is shown. The "Transient Pedestal" output signal from your UPC (J5-3) is active for the duration shown by the **Transient Event** row.

### Segments

Segments describe the program transient. The segments listed in the table are the same segments show in the Programs panel.

### Steps

In order to smoothly perform the desired voltage or frequency change specified in a segment, the UPC firmware breaks each segment into discrete steps. There can be up to 100 steps in a segment. The detailed voltage and frequency values the UPC firmware calculates for each step is shown in separate rows in the table.

## 10.4 Graph View and Controls

The right half of the window shows a graphical representation of the **Output Steps**. The graph is a simulation of the actual UPC waveforms created by the selected program.

### Graph Cursors

Each time you click on a row in the table view, the cursors are automatically positioned in the graph relating to the start and end time of that row. Similarly, when you click on an arbitrary place in the graph, the row relating to that item is automatically highlighted in the table view.

### Graph HPos and HDiv

These controls allow you to pan and zoom the time axis of the graph. The values are in seconds. The **HPos** (Horizontal Position) can be positive or negative. Negative time values always refer to the steady state portion of the program.

### L-N and L-L

These controls allow you to view the waveforms as Line-Neutral or Line-Line.

## Navigation

In addition to using the mouse, you can use the arrow keys to navigate through the table rows. The arrow keys also change the cursors in the graph and scroll the graph view as necessary.

## Phase Checkboxes

These checkboxes allow you to show or hide a particular phase.

## 10.5 Info Bar

The **Info Bar** shown at the bottom of the **Program Preview** window shows details related to the selection.

## 10.6 Printing and Exporting

You can print the graph or export the output steps to a file. Right click the mouse in the table or graph and a context menu appears.

## 10.7 Updating Values

Anytime you change values in the Programs panel or Output Sequence window, the **Program Preview** window is automatically updated.

## 11 UPC Meter V/I Display

The **UPC Meter** window is shown below. This window is automatically displayed after connecting to your UPC using either UPC Studio or UPC Control. The type of information displayed in the UPC Meter window depends on the Toolbar Display button selected. The date and time the last measurement was completed is shown in the title bar of the window.

### 11.1 V/I Display

The first time the UPC Meter window is opened, the default view is the V/I Display and metered values are automatically updated. Subsequently, you must click the **Refresh** button to update the values. The format of the V/I Display Table depends on the power source output Form currently executing.

Labels in the image:

- V/I Display Button
- V/I Display Menu
- Measurement date and time
- Refresh button
- Measurement Templates
- V/I Display Table

	Phase A	Phase B	Phase C
Vrms(L-L)	204.171	204.171	204.171
Irms	6.468	6.468	6.468
Ipeak	9.173	11.187	6.480
Icrest	1.416	1.727	1.002
KW	0.780	0.779	0.777
KVA	0.780	0.779	0.777
PF	1.000	1.000	1.000
Frequency	60.000	60.000	60.000

## 11.2 Refresh and Toolbar Display Buttons

The various buttons in the toolbar are described below:



This queries your UPC for the meter values specified by the selected toolbar button as described below. It then updates the values shown in the window.



This button selects the volt/amp metered values shown above. These values also include the output power, power factor and frequency.



This button selects the waveform metered values.



This button selects the voltage harmonics metered values. This button is only available if your UPC firmware contains the Harmonics Analysis and Synthesis option.



This button selects the amp harmonics metered values. This button is only available if your UPC firmware contains the Harmonics Analysis and Synthesis option.

## 11.3 V/I Display Menu and Measurement Templates

The V/I Display button must be pressed before you can access the V/I Display Menu. This menu allows you to start/stop data logging and select **measurement templates**. Measurement templates are files that define which measurements are made during data logging or when refreshing the V/I Display Table. These files are located in the Templates folder (typically "C:\Pacific Power Source\UPC Manager\Meter Data\Templates"). You can edit or create these files. Shown below is a sample template file opened in Microsoft Excel:

	A	B	C	D
1	# Pacific Power Source VI Meter Template			
2	# "1" = Measure 0 = Skip"			
3				
4	Function	Phase A	Phase B	Phase C
5	Vrms (L - N)	1	1	1
6	Vrms (L - L)	0	0	0
7	Irms	1	1	1
8	Ipeak	0	0	0
9	Icrest	0	0	0
10	KW	0	0	0
11	KVA	0	0	0
12	PF	0	0	0
13	Frequency	0	0	0
14	Degrees	0	0	0

Rows 4-13 correspond to the rows and columns in the V/I Display Table. Only cells with a "1" will be measured as shown below:

Function	Phase A	Phase B	Phase C
Vrms(L-N)	120.603	120.465	120.219
Vrms(L-L)			
Irms	6.484	6.482	6.472
Ipeak			
Icrest			
KW			
KVA			
PF			
Frequency			

### Measurement Template Notes:

- Template file names must use a \*.csv extension. Only template files stored in the ...\\Meter Data\\Templates folder appear in the menu. The name shown is the file name without the extension. Files you copy or create automatically appear in the menu the next time you click it.
- The actual rows and columns displayed in the V/I Display Table depend on the output Form.
- The Phase B and C columns in the template file are ignored (not measured) for Form 1 and 2.
- For Form 1, the Vrms (L-L) row is not displayed. The Vrms (L-N) template file row controls the Form 1 V/I Display Table Vrms value.
- For Form 2, the Vrms (L-N) row is not displayed. The Vrms (L-L) template file row controls the Form 2 V/I Display Table Vrms value.
- The fewer the measured values, the faster the measurement speed (this mostly affects data logging).
- For the **Frequency** row, the Phase A template file cell controls all phases shown in the V/I Display Table.

## 11.4 File Menu

The **File** menu allows you to export, import or print measurements in the **UPC Meter** window.

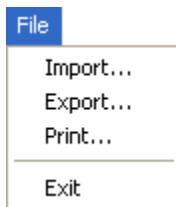

**Export** allows you to save the measured values presently shown in the window. **Import** allows you to view a previously saved (exported) measurement. The data format of the file is \*.csv (Microsoft Excel). The date and time shown in the title bar of the window is the time the measurement was originally taken



## 12 UPC Meter Waveform Display

When you press the **Waveform** button in the UPC Meter toolbar, the window appears as shown below:

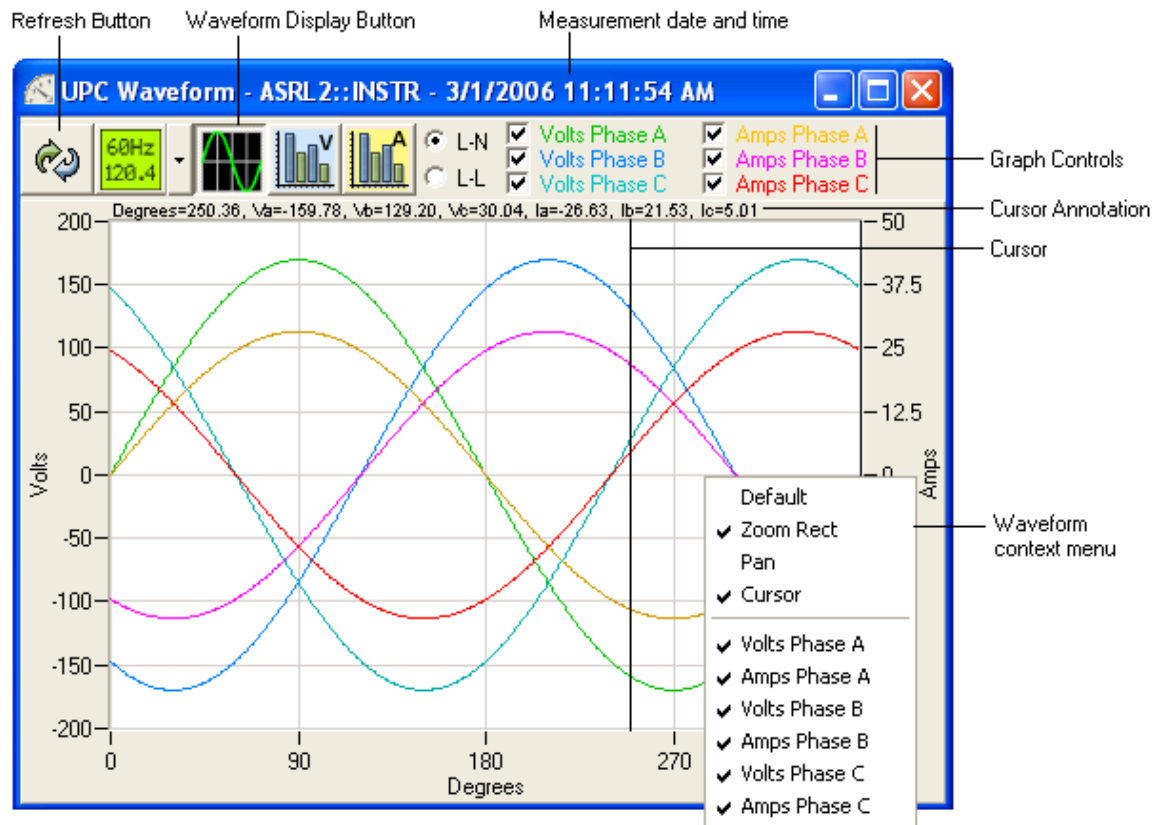

When you select the Waveform Display button for the first time, the display is automatically updated. Subsequently, you must click the Refresh button to update the waveforms. If you right-click on the waveform graph, a context menu appears that allows you to select the **Pan** or **Zoom** option. These options control the mouse behavior when you click and drag the mouse over the waveform. The **Default** item restores the **Pan** and **Zoom** state to the normal values (centered, 100%). The **Cursor** item displays a vertical line in the graph that tracks the mouse movement and text annotation appears above the graph showing the values at the cursor location. The remaining items in the menu control which waveform is visible.

## 13 UPC Meter Harmonics Display

The Harmonics display is only available if that firmware option was installed in your UPC at the factory. The Harmonics display is accessed by pressing either the **Volts Harmonic** or **Amps Harmonic** buttons in the UPC Meter toolbar. The default harmonics view is a bar chart as shown below.

### 13.1 Bar View

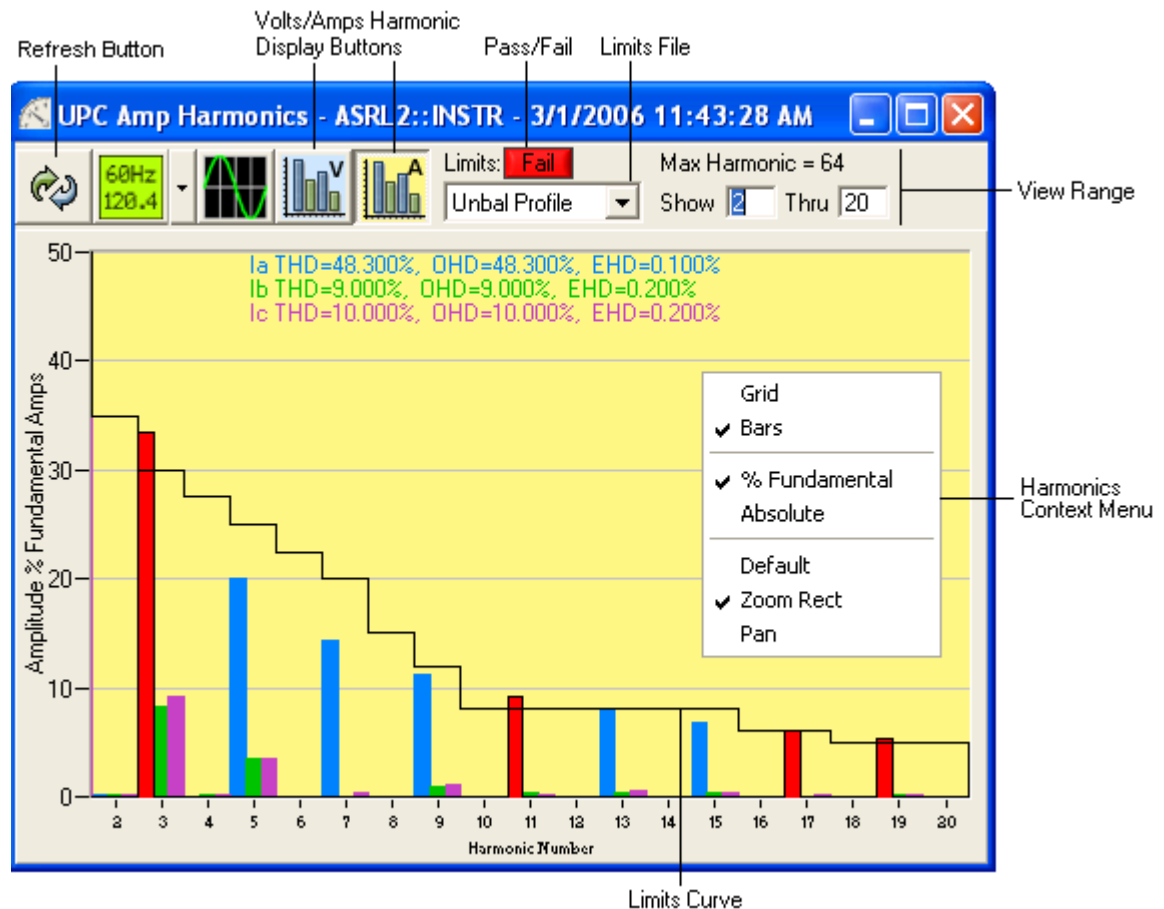

When you select the Volts or Amps Harmonic Display buttons for the first time, the display is automatically updated. Subsequently, you must click the **Refresh** button to update the measured values. You can specify the range of harmonics to be displayed and if the amplitude should be expressed as a percentage of the fundamental or as absolute values by

using **Harmonics Context menu**. Different phases (Form 3) are shown using different colors. If a particular bar is **red**, it means the amplitude of that harmonic and phase exceeds a predefined limit. For more information on limits and the Limits Curve, refer to the Limits File section below.

## 13.2 Grid View

The Grid view is accessed using the Harmonics Context menu and appears as shown below:

Harmonic	Ia Mag%Fund	Ia Phase	Ib Mag%Fund	Ib Phase	Ic Mag%Fund	Ic Phase	Amps Limit
THD	48.3		9.0		10.0		14
OHD	48.3		9.0		10.0		7.65
EHD	0.1		0.2		0.2		3.28
1	100.0	0.0000	100.0	0.0000	100.0	0.0000	
2	0.1	211.9	0.1	179.9	0.1	180.8	35
3	33.4	0.0	8.2	0.0	9.2	0.1	30
4	0.0	267.5	0.1	180.1	0.1	175.0	27.5
5	20.0	0.0	3.5	179.9	3.5	179.9	25
6	0.0	270.4	0.0	141.8	0.0	146.8	22.5
7	14.3	0.1	0.0	142.8	0.4	182.7	20
8	0.0	338.2	0.0	225.5	0.0	143.9	15
9	11.2	0.0	1.0	0.5	1.1	0.8	12
10	0.0		0.0	162.7	0.0	158.5	8
11	9.2		0.4	178.2	0.2	176.6	8
12	0.0		0.0	199.6	0.0	153.3	8
13	7.9		0.3	177.3	0.5	177.9	8
14	0.0		0.0	311.3	0.0	240.0	8
15	6.8	0.1	0.4	0.0	0.3	2.5	8

The harmonics grid view shows both the amplitude and phase angle for all phases in one table. It also shows the Total Harmonic Distortion (THD), Odd Harmonic Distortion (OHD) and Even Harmonic Distortion (EHD).

## 13.3 Pass/Fail

This indicator is **red** if any measured harmonic amplitude or distortion is above the specified limit. This indicator is not shown if no limits are selected ("None"). Pressing this button causes all harmonics to be displayed in the **Bar View**.

## 13.4 Limits File

The Limits File drop down menu allows you to specify a file containing limit values to check the measured values of THD, OHD, EHD and harmonic amplitude. The drop down menu also allows selecting "None" so no limits checking are performed. When a limits file is specified, items with a **red** background in the Bar or Grid view mean the measured value exceeds (fails) the limit test. For the Grid view, items with a **green** background mean the measured value is equal to or less than (passes) the limit test. A white background in the Grid view means a limit value was not defined for that value so no limit testing was performed.

Limits files are stored in the Harmonics Limits folder located in the same directory as the UPC Manager application (typically "C:\Pacific Power Source\UPC Manager\Harmonics Limits"). Limits files are text files with a \*.csv extension and contain rows of comma separated values. Shown below is a sample limits file opened in Microsoft Excel:

	A	B	C	D	E
1	[Column Header	VOLTS % FUND	AMPS % FUND	VOLTS ABSOLUTE	AMPS ABSOLUTE]
2	Desc		Amps Limit		
3					
4	[% DISTORTION	VOLTS % FUND	AMPS % FUND	VOLTS ABSOLUTE	AMPS ABSOLUTE]
5	THD		14		
6	OHD		7.65		
7	EHD		3.28		
8					
9	[HARM #	VOLTS % FUND	AMPS % FUND	VOLTS ABSOLUTE	AMPS ABSOLUTE]
10	1				
11	2		35		
12	3		30		
13	4		27.5		
14	5		25		
15	6		22.5		
16	7		20		
17	8		15		
18	9		12		
19	10		8		
20	11		8		
21	12		8		
22	13		8		

Columns B, C, D and E correspond to the 4 types of harmonics data that can be displayed in the Bar or Grid views. In the above bar and grid examples, "Amps % Fundamental" was selected by using the Toolbar

buttons and Harmonics context menu. This corresponds to column "C" in the Excel file. This means these values will be used to check the measured values. The Grid view also shows these values in the far right column. The Bar view shows these values in the Limits Curve.

Only items in the Limits File that contain values are used to check the measured values. If the corresponding entry in the limits file is blank, then the measured value is not checked. In the above example, all the limits values for columns B, D and E are blank so none of the measured values for "Volts % Fundamental", "Volts Absolute" or "Amps Absolute" will be checked. Also, you don't have to specify every harmonic (row) in the limits file. The measured values for skipped rows are not checked. In the above Excel example, row 10 (Harmonics #1) could have been deleted since columns B, C, D and E were blank.

## 14 Data Log

The UPC Meter window allows you to log measurement results to a file. To start data logging:

- 1) Open the UPC Meter window and click on the V/I Display button menu as shown below. Note that the V/I Display button must be pressed before you can access the menu.

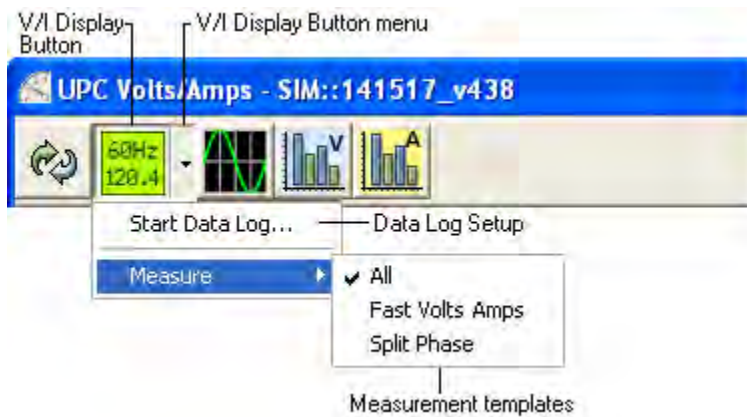

- 2) Specify the desired measurement template then select **Start Data Log...** Refer to the measurement templates section for more information.
- 3) The **Data Log Setup** window appears as shown below:

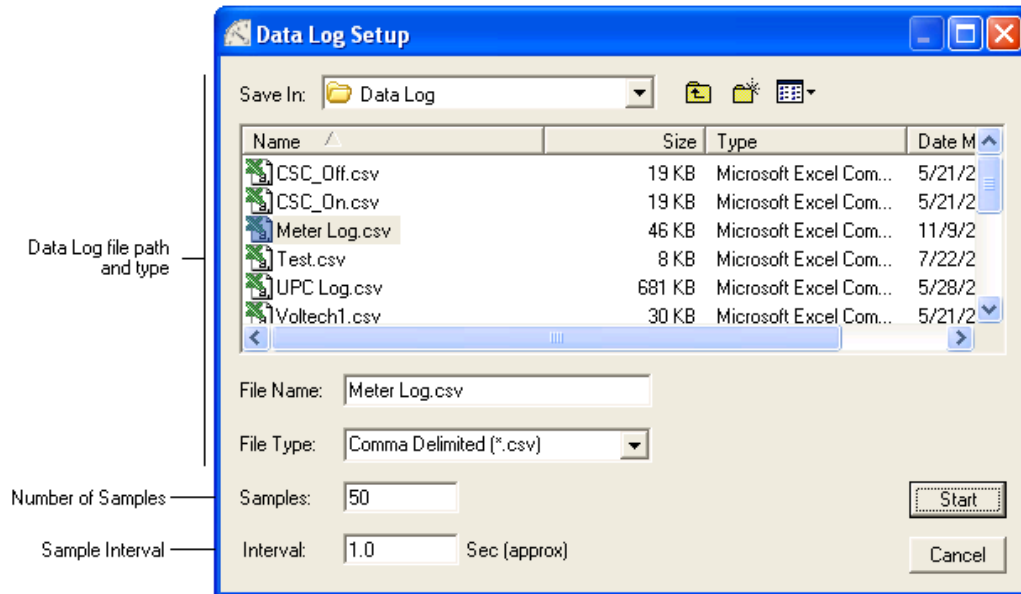

Specify the file name, number of samples and sample interval. For \*.csv files, keep in mind the maximum number of samples supported by Excel is 65532. A warning icon is displayed if the value you enter is greater. Sample intervals below 1 second default to "MIN". The minimum time is based on your UPC configuration, template file, and remote interface communication speed. After you enter the desired values, press **Start**.

- 4) During data logging, the V/I Meter window updates as each sample is taken. The display also shows the entry number, elapsed time and progress of the data log as shown below:

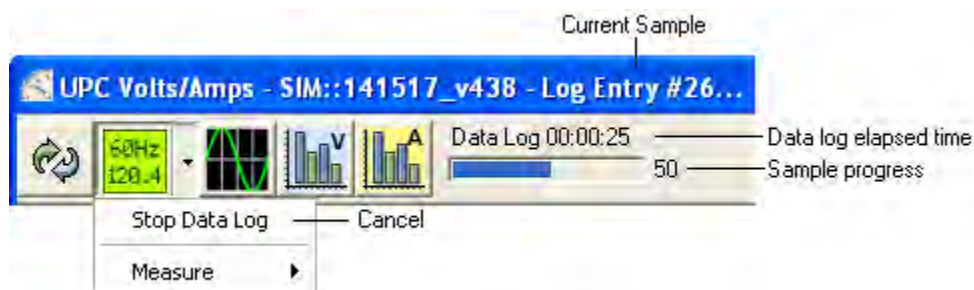

You can cancel data logging by choosing **Stop Data Log** from the V/I Display button menu.

**Notes:**

- The data log file includes a date time stamp and the precise elapsed time for each sample.
- The measurement template file determines which values are measured and stored in the data log file.
- The time accuracy of the data log interval is approximate and depends on the Windows operating system and other running applications.
- Data logging pauses when another UPC Manager window is activated and resumes when the UPC Meter window is reactivated.
- The maximum number of samples is 2,147,483,647 but may be less depending on available disk space. Each entry in the data log file takes around 200 bytes.



## 15 Reading UPC Settings

The Read UPC Settings window stores all the values in your UPC to a file on your PC. This is a convenient way to "back up" your UPC. The settings file you create can also be used to update other UPCs.

**Note:** If you intend to create settings files to be used with other UPCs, you should **uncheck** the "Read kFactors" check box. That way, these values will not be saved in the file so they can't then accidentally be sent when writing the file to another UPC.

To read settings from your UPC and save them to a file on your PC, perform the following steps:

1. Press the **Read Settings From UPC** icon in the toolbar
2. A dialog box will appear asking you for the name of the file you want to create. The default name is "UPC Settings" but it helps to enter a name that better describes your particular UPC. After you specify the name of the file, press **Save**.
3. The **Read UPC Settings** window appears as shown below. The name of the settings file you specified is shown in the title bar of the window.
4. Press the **Change** button. The UPC Interface Connection window will appear. Enter the interface (Serial or GPIB) and settings used by your UPC then press **OK**. You can view the communication settings of your UPC on the built-in LCD display by pressing Fn 3, 3.
5. The **Read UPC Settings** window shows a list of items with checkboxes that show the various settings categories that will be read. You should normally check all items, but un-checking an item may assist troubleshooting a particular problem. Some items are checked and dimmed meaning that item is mandatory.
6. Press the **Start** button. The progress of reading UPC settings is shown in the window.
7. When all items have completed, you will be asked if you want to view the settings that were just created. You can choose **Yes** to view it now (read-only) or you can later use the **Open** icon in the toolbar to open the file in Edit mode so you can make changes.

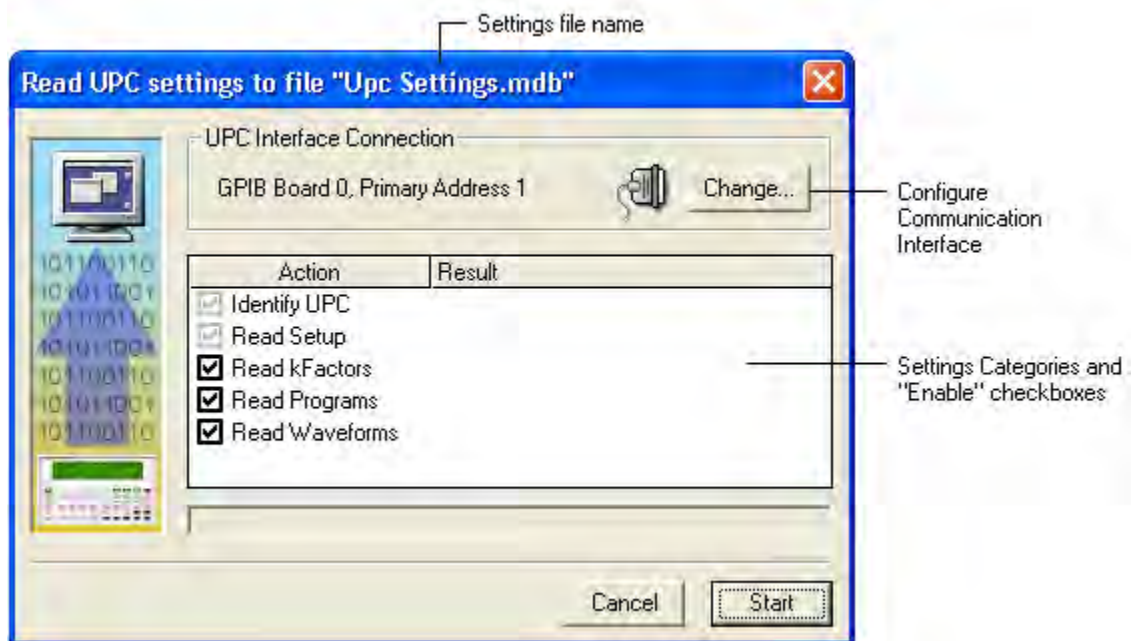

## 16 Writing UPC Settings

**Warning:** This operation overwrites settings stored in your UPC.

The Write UPC Settings window sends values from a settings file on your PC to your UPC. This is a convenient way to "restore" your UPC or update other UPCs.

**Note:** If the settings file you intend to write was created by a different UPC, you should **uncheck** the "Write kFactors" check box. Otherwise, the calibration of your UPC will be affected.

To write a settings file to your UPC, perform the following steps:

1. Press the **Write Settings To UPC** icon in the toolbar
2. A dialog box will appear asking you for the name of the file you want to write. Select the desired file then press **Open**.
3. The Write **UPC Settings window** appears as shown below. The name of the settings file you selected is shown in the title bar of the window.
4. Press the **Change** button. The UPC Interface Connection window will appear. Enter the interface (Serial or GPIB) and settings used by your UPC then press **OK**. You can view the communication settings of your UPC on the built-in LCD display by pressing Fn 3, 3.
5. The **Write UPC Settings** window shows a list of items with checkboxes that show the various settings categories that will be written. You can optionally uncheck one or more items to skip writing those settings. If the kFactors category is checked, calibration values in your UPC will be updated. Make sure the kFactors in this settings file are correct for this UPC. Otherwise you will be forced to recalibrate your UPC. Refer to the UPC Programmable Controller Operation Manual for instructions on calibration. (**Note:** The Hardware Configuration row sends the Transformer Ratio, Amps Volts Ratio, Current Transformer Location (Primary/Secondary) and Number of Amplifiers. These values define the hardware configuration of your power source. Carefully check your power source documentation and hardware to verify that these values are correct.)

6. Press the **Start** button. The progress of writing UPC settings is shown in the window.

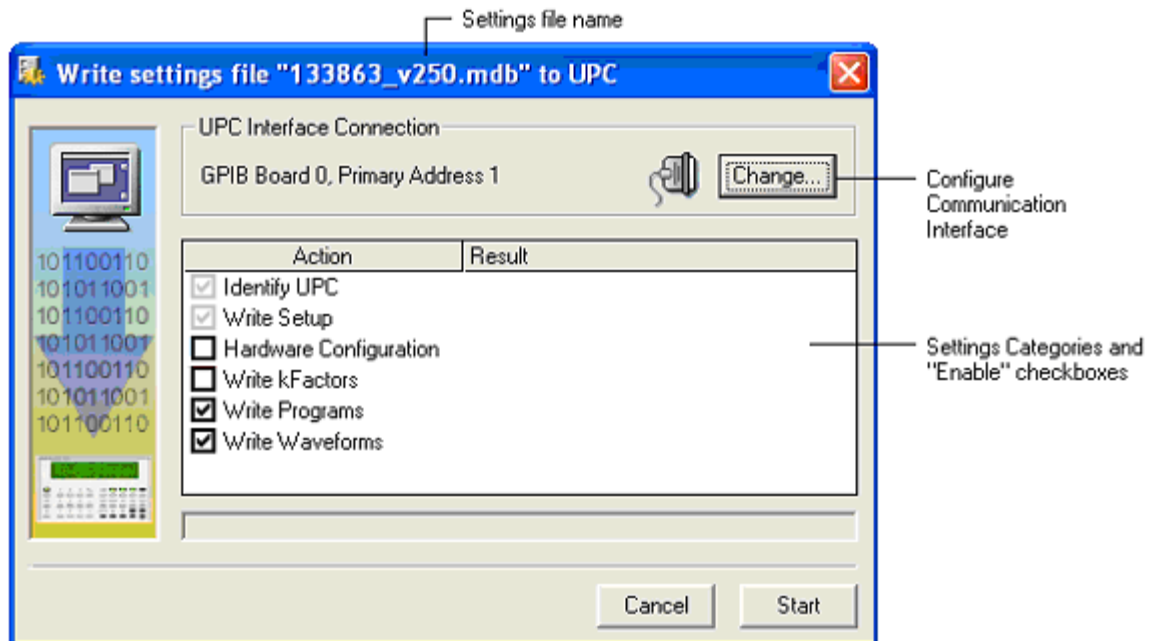

## 17 UPC Settings Interface Connection

You access the **UPC Interface Connection** window from either the **Write UPC Settings** or **Read UPC Settings** windows. If your UPC is connected to a serial port, press the **Serial** tab and the window appears as shown below:

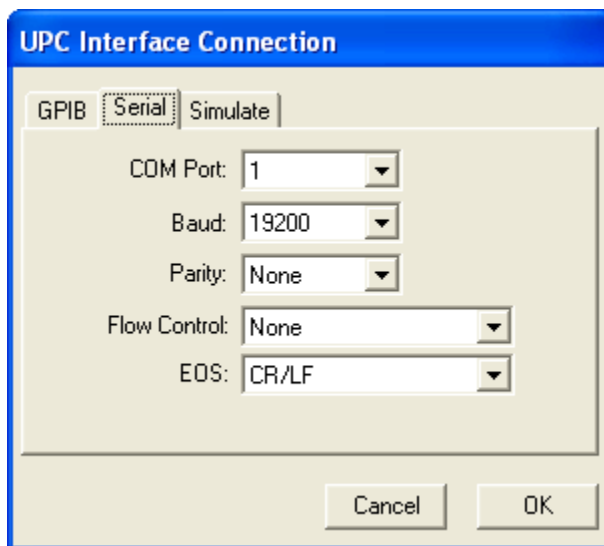

The Baud Rate, Parity and EOS should match the values in your UPC. Press Fn 3, 3 on the UPC front panel to view these UPC communication settings. The **Flow Control** item shown above should be set to "None". Once you have entered the desired values, press **OK**. The tab (Serial or GPIB) you last selected prior to pressing OK is the interface that UPC Manager will use.

If your UPC is connected to a GPIB port, press the **GPIB** tab and the window appears as shown below:

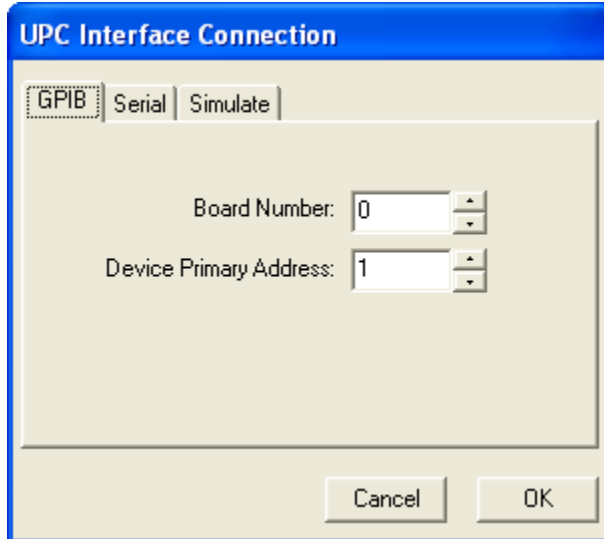

The Board Number is assigned by your system to the GPIB card installed in your PC. The Device Primary Address is the GPIB address of your UPC. You can view the GPIB address by pressing Fn 3, 3 on the UPC front panel. Enter the desired values in the window above then press **OK**. The tab (Serial or GPIB) you last selected prior to pressing OK is the interface that UPC Manager will use.

You can also connect to a simulated UPC. The simulation mode allows you to operate a virtual UPC. The simulation mode is also a convenient way edit/view UPC settings offline. Press the **Simulate** tab and the window appears as shown below.

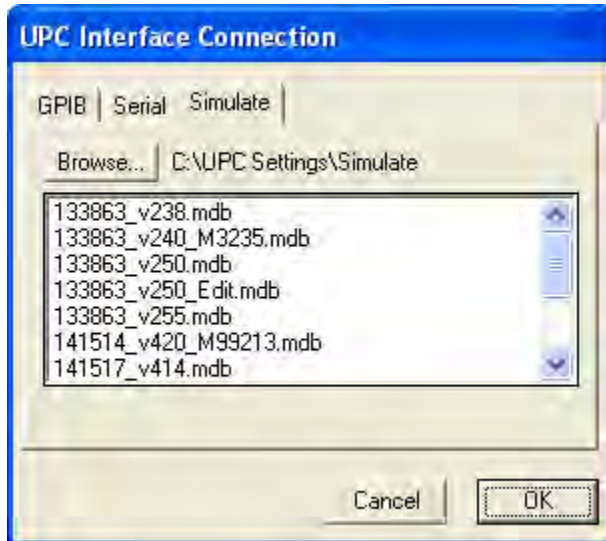

The list shows the available simulation files located in the folder path shown next to **Browse...** Simulation files are actually settings files that are created when using Read Settings from UPC.

You can verify the available system resources (serial ports and GPIB interfaces) installed on your PC by pressing the **About** icon in the toolbar.

## 18 Troubleshooting Guidelines

- Make sure the necessary software is installed on your PC
- Make sure your UPC is in the "V/I METER:" display mode. The "V/I METER:" display mode allows your UPC to communicate with your PC.
- Verify system resources.
- If you are having problems running the UPC Manager Installer, try updating your operating system with the latest service pack.
- When reading or writing settings, check that the communication settings match your UPC settings
- If UPC Manager Preferences become corrupted, press and hold the <Shift> key when opening UPC Manager. UPC Manager Preferences include window position and sizes, communication settings, file paths and saved commands in the Probe window.
- If the RAM in your UPC becomes corrupted, you may have difficulty writing a settings file. First reset the UPC RAM (FN 1, 3) then try sending the settings file. **WARNING: FN 1, 3 will delete all RAM settings including calibration values (kFactors). Do not use FN 1, 3 unless you previously saved a settings file of this UPC or you are willing to re-enter all values and calibrate the unit.**

## 19 Firmware Versions

The View/Edit UPC Settings or UPC Control window shows the firmware version in the **Info** panel. UPC Studio also shows the firmware version in the status bar at the bottom of the window. You can also view the firmware version on the UPC built-in LCD display by pressing Fn 3, 3. The paragraphs below show which items are unavailable with older versions of the UPC firmware. If you want your UPC to support these features, contact Pacific Power Source for information on upgrading your firmware.

### 19.1 UPC-12/32 Firmware

UPC-12/32 firmware prior to version 5.0 does not support the following operations through the remote interface:



- Determine if the firmware contains a MOD (customer specific option) and the MOD number.
- Query "Volt Limit Min/Max", "Range Control", "Amps Volt Ratio", "CT Location" or "Amplifiers". Also, if the firmware assembly supports ProgZo, you can't query the "ProgZo Cal Xfrm Ratio" values. When UPC Manager attempts to read these settings, it sets the values to the defaults shown in the table below.
- Query program catalog. The program catalog allows the remote interface to quickly determine which programs are stored.
- Query the currently executing program name.

UPC-12/32 Setting	Default Value
Volt Limit Min	0
Volt Limit Max	600
Range Control	0 - Auto
Amps Volt Ratio	4
CT Location	Secondary
Amplifiers	3
ProgZo Cal Xfrm Ratio 1	1.5
ProgZo Cal Xfrm Ratio 2	2
ProgZo Cal Xfrm Ratio 3	2.5

When reading settings from your UPC-12/32, it's important to note that the above default values will be substituted for the values presently stored in your UPC-12/32. When writing this settings file, the default values for "Volt Limit Min/Max", "Range Control" and "ProgZo Cal Xfrm Ratios" will be written to your UPC. "Amps Volts Ratio", "CT Location" and "Amplifiers" are not important because they are not written to the UPC-12/32 but are configured by DIP switches inside the UPC-12/32.

## 19.2 UPC-1/3 Firmware

UPC-1/3 firmware prior to version 5.0 does not support the following operations through the remote interface:

- Query program catalog. The program catalog allows the remote interface to quickly determine which programs are stored.
- Set the CT Location.
- Query "Range Control" and "CT Location".
- Query or set "Transient Auto RMS".
- Query the currently executing program name.

<b>UPC-1/3 Setting</b>	<b>Default Value</b>
Range Control	0 - Auto
Transient Auto RMS	On
CT Location	Secondary

When reading settings from your UPC-1/3, it's important to note that the above default values will be substituted for the values presently stored in your UPC-1/3. When writing this settings file, the default value for "Range Control" will be written to your UPC. As mentioned earlier, the value for "CT Location" is not sent to your UPC because this command is not supported by the older firmware.

## 20 System Resources

The **About** window allows you to view the system resources like the available serial or GPIB interfaces. To view the About window, press the **About** icon in the toolbar.



The **About** window shows a list of system resources that are described below:

Resource Name	Description
Visa	Required software driver
ASRLn::INSTR	Serial COM port n
GPIBn::INTFC	GPIB interface board number = n
GPIBn:INSTR GPIB	GPIB Instrument device primary address = n



If no interfaces are listed, make sure NI-VISA and NI-488.2 software are installed.

You can also use Measurement & Automation Explorer (MAX) available from National Instruments to view the installed hardware and software on your PC. The **Devices and Interfaces** section will show the installed interface hardware and instruments and the **Software** section will show drivers and versions.

# upc studio

## Appendix A

### Program Map

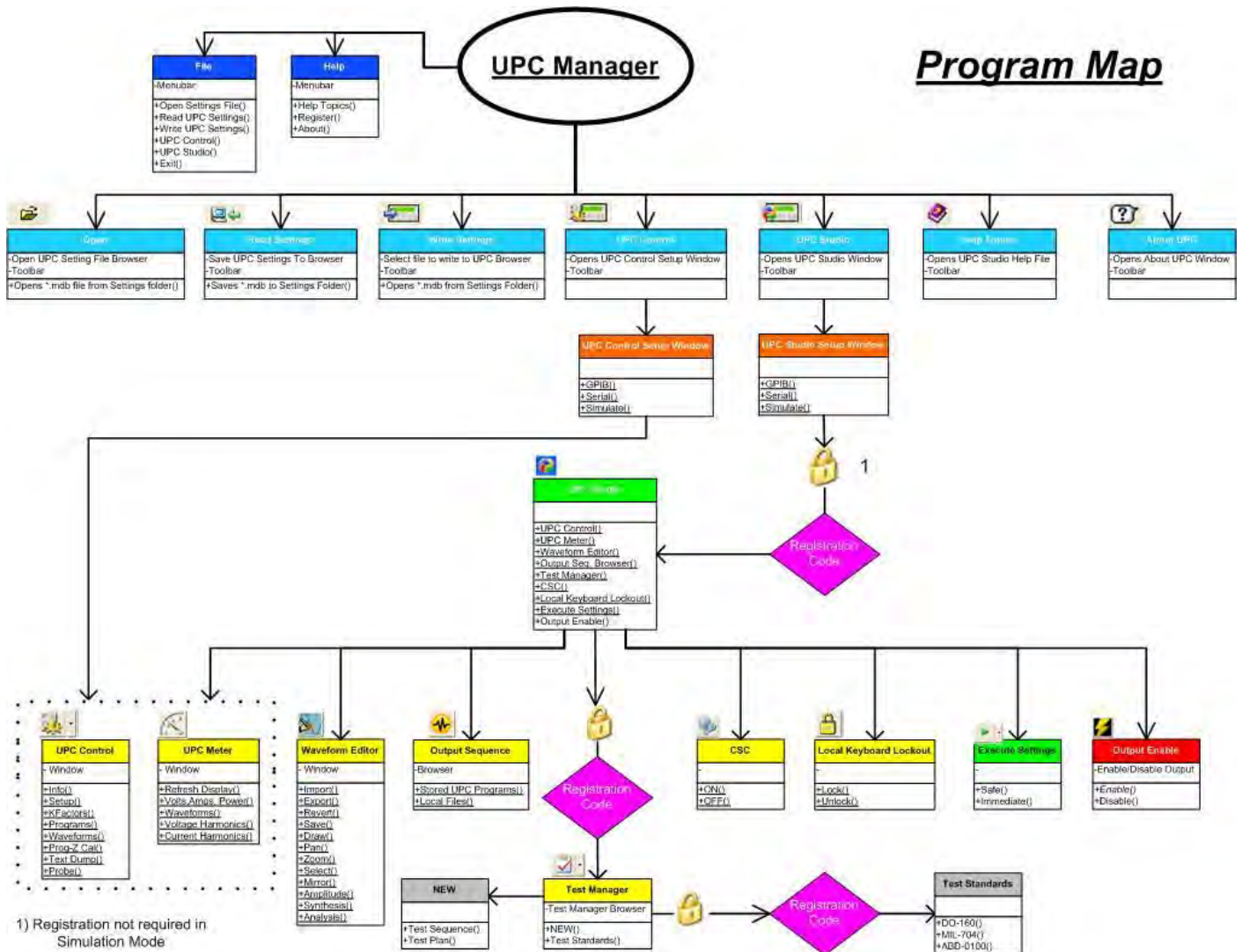

1) Registration not required in Simulation Mode

# upcstudio

## Help Topics Map

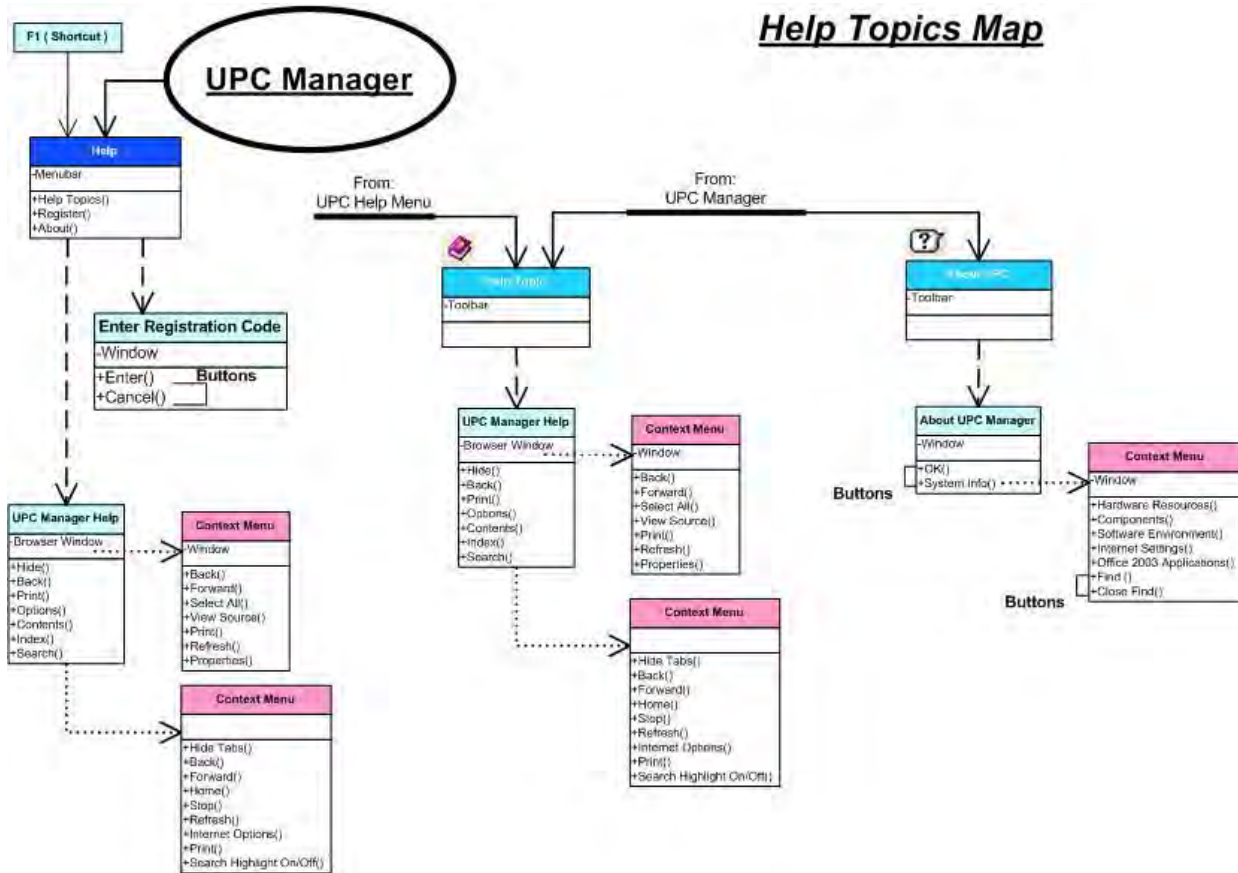

# upc studio

## UPC Settings File Map

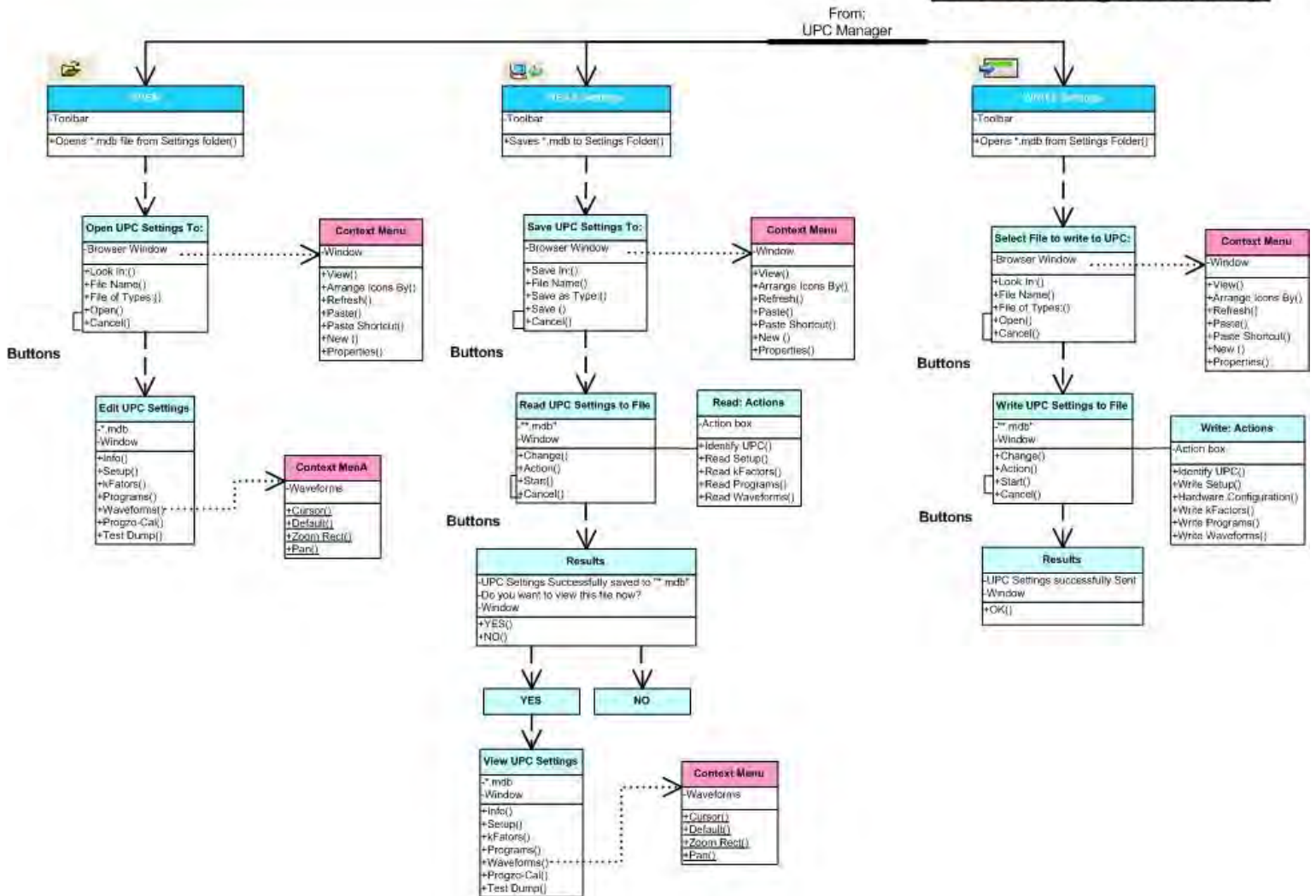

# upc studio

## UPC Interface Setup Map

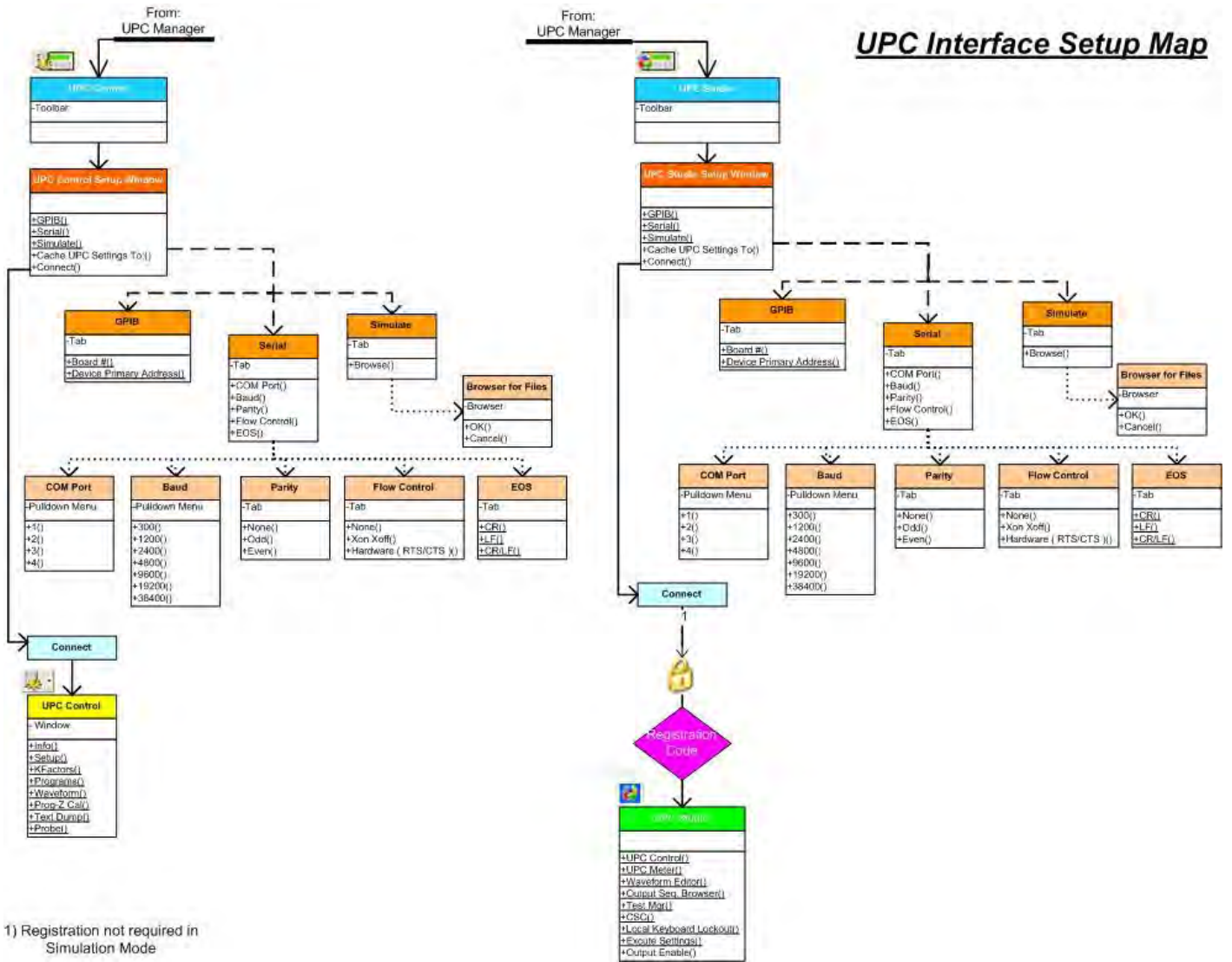

1) Registration not required in Simulation Mode



# upc studio

## UPC Studio Map

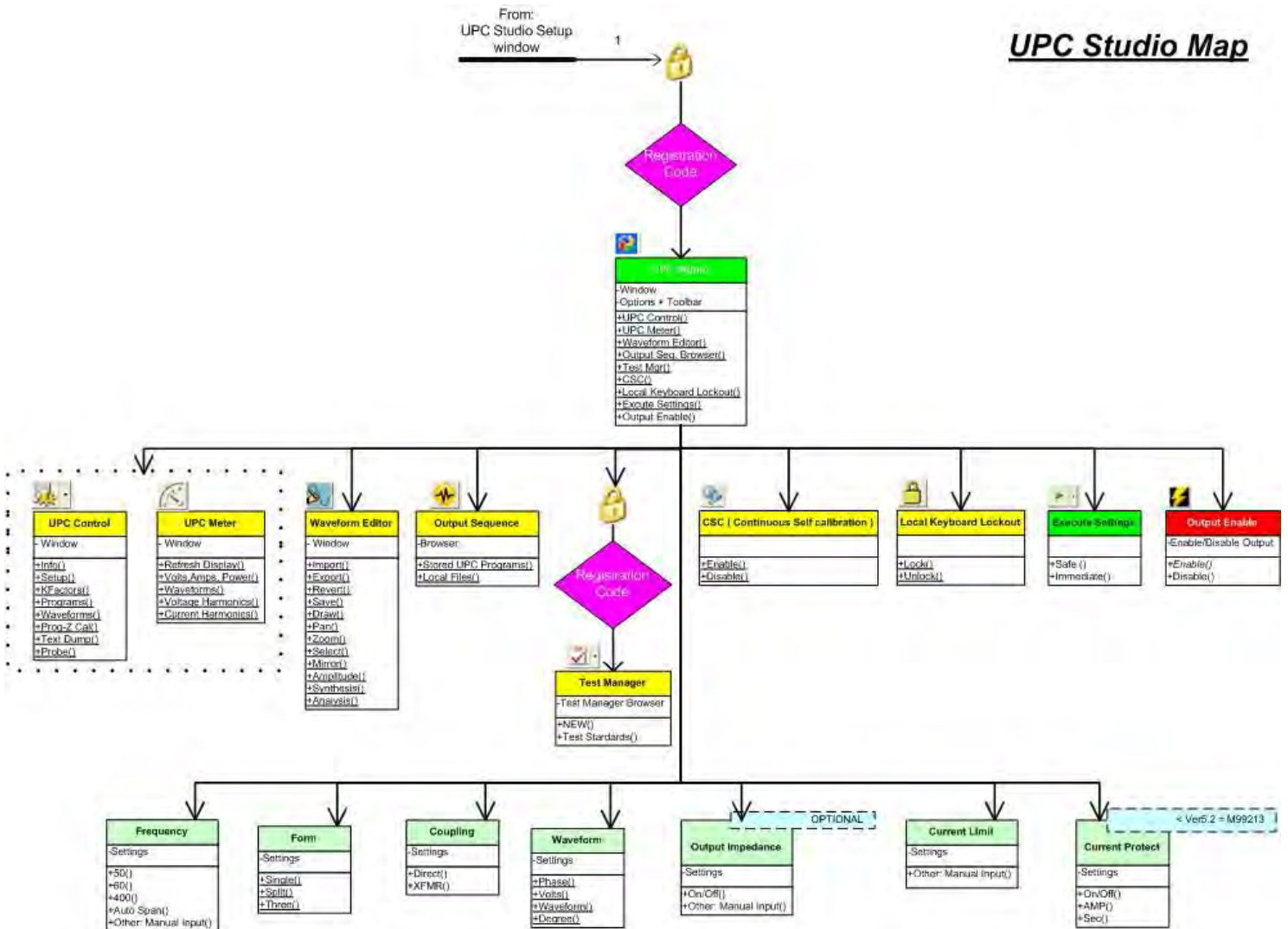

1) Registration not required in Simulation Mode

## UPC Control & Meter Map

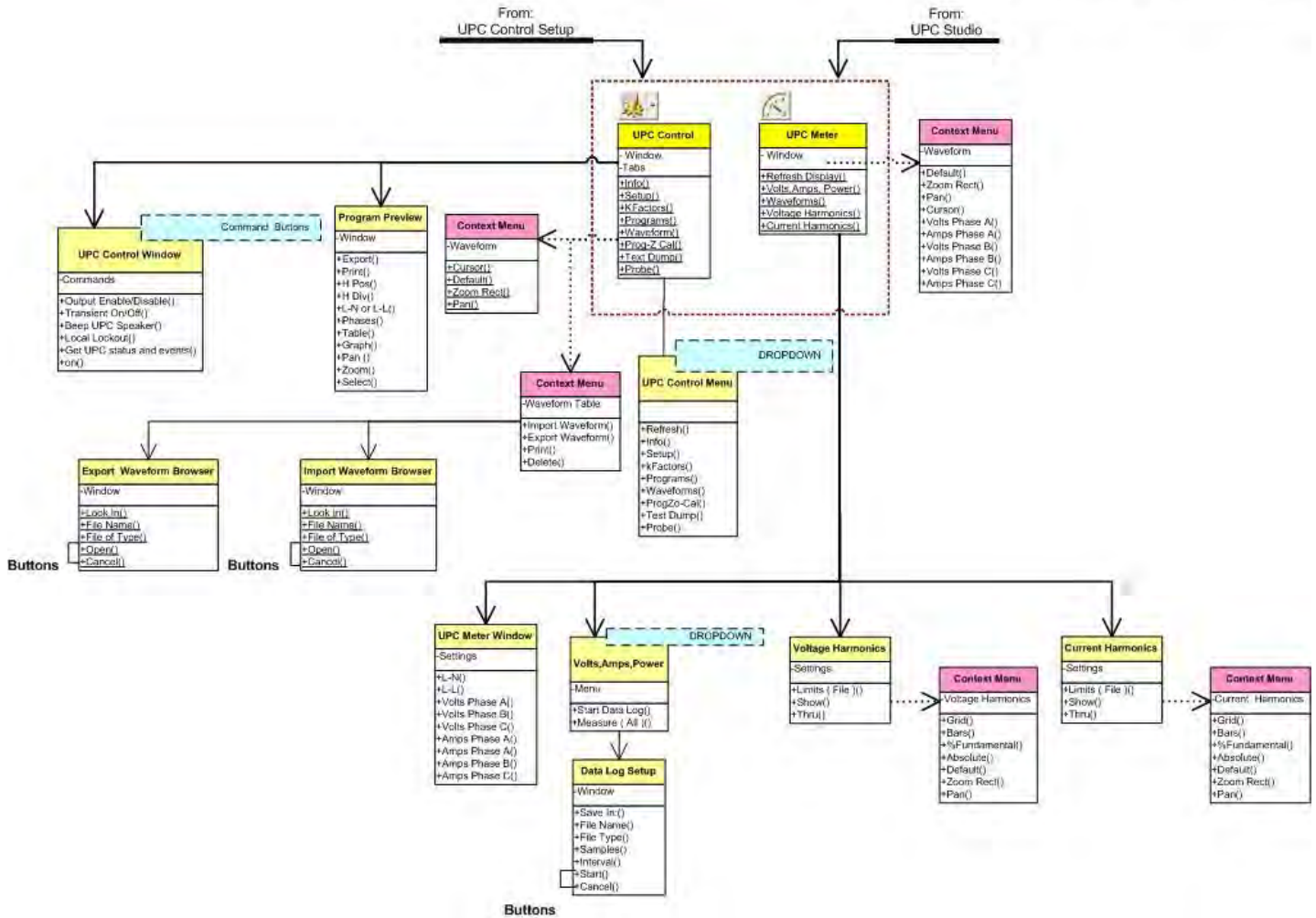

## UPC Waveform Editor Map

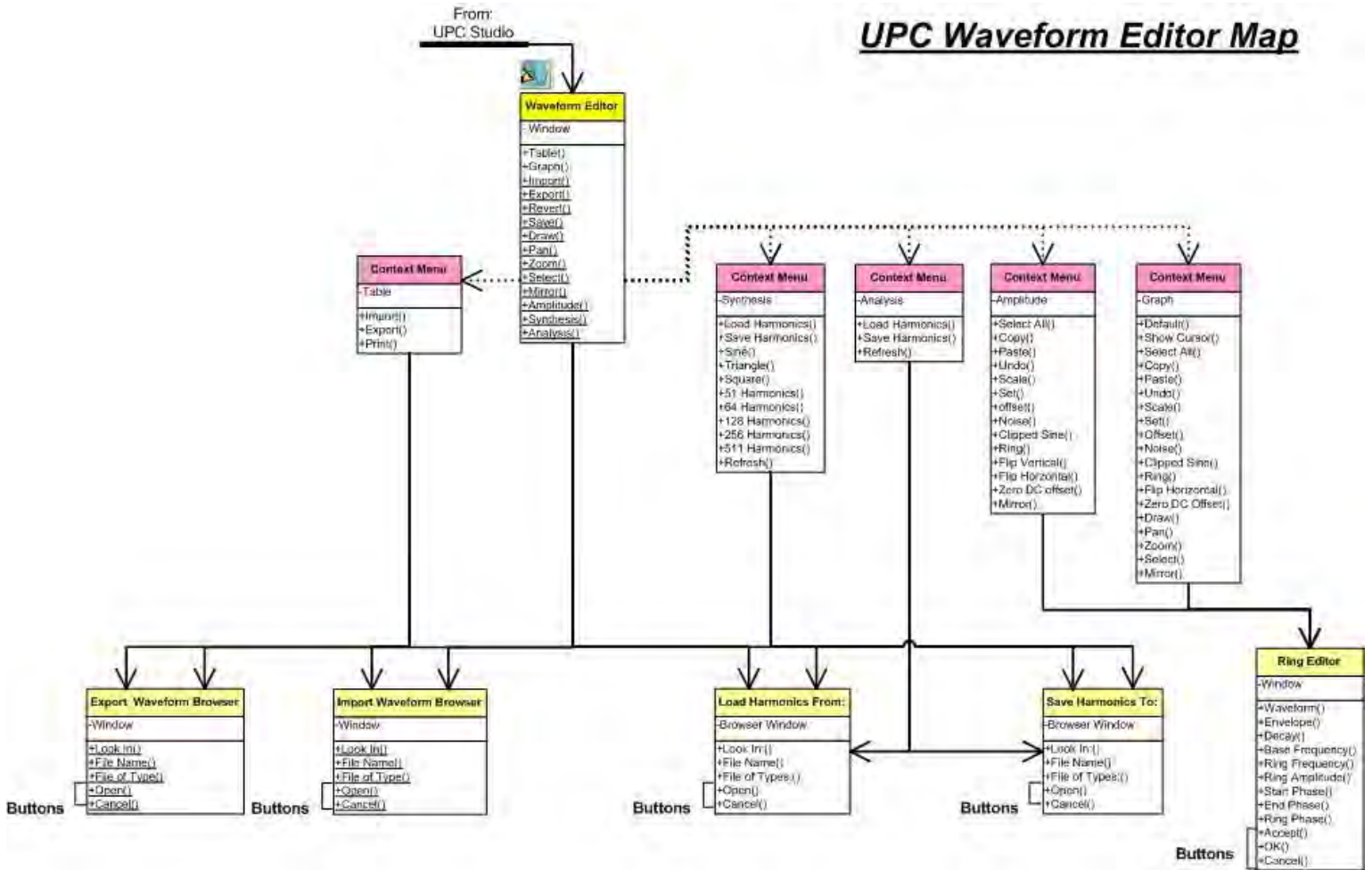

## Output Sequence Browser Map

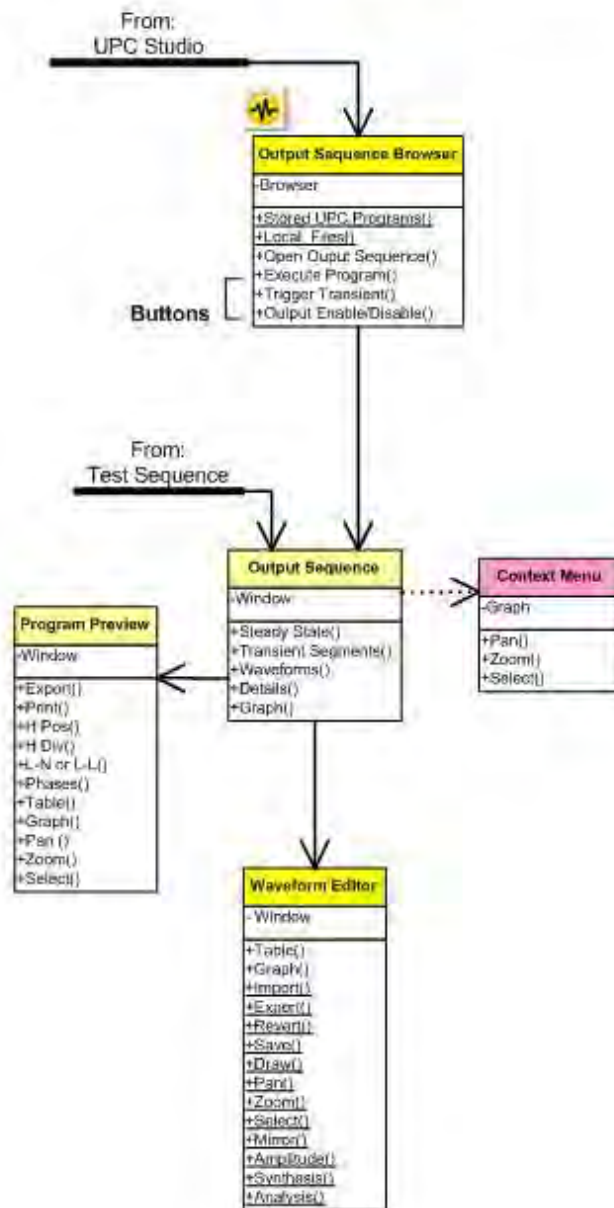

## Test Manager Map

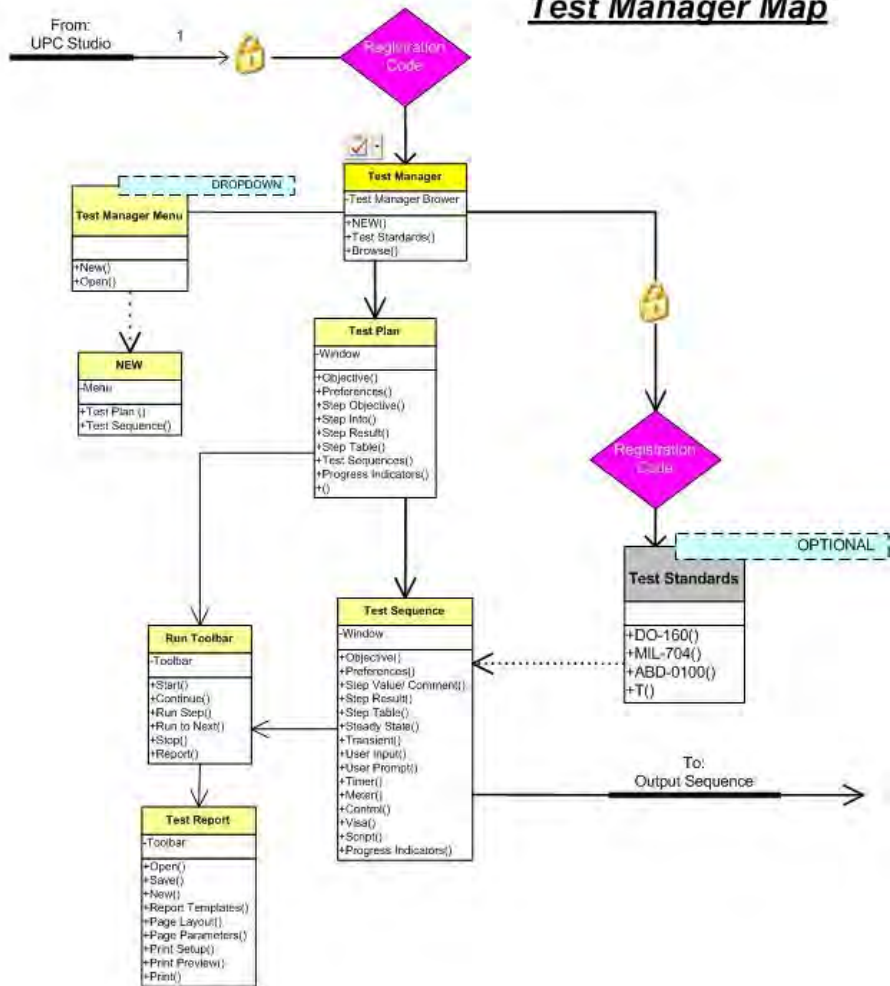

1) Registration not required in Simulation Mode

## INDEX

---

### **A**

accuracy · 49, 105, 109, 110, 134  
 Amplitude · 15, 24  
 Amps · 56, 58, 128, 131, 137, 143  
 Analysis · 123  
 Auto RMS · 36, 144

---

### **B**

Beep · 56

---

### **C**

Calibration · 11  
 Clear · 43, 53, 96, 115  
 Command · 43, 89, 112, 114  
 Configuration · 137  
 Continue · 50, 59, 93  
 Control · 4, 11, 12, 42, 45, 52, 54, 65, 100, 101, 102, 103, 104, 105, 106, 107, 108, 109, 110, 111, 112, 113, 114, 116, 117, 118, 122, 139, 142, 143, 144  
 Copy · 17, 33, 52, 95  
 Coupling · 41, 76  
 CRC · 14, 26, 35, 74  
 CSC · 9, 11, 54, 60  
 Current · 12, 103, 137  
 Cursor · 17, 20, 35, 108, 126  
 Cut · 33, 52, 95

---

### **D**

Data · 19, 58, 60, 99, 123, 125, 132, 134  
 DC offset · 15, 18  
 Default · 15, 17, 35, 109, 126, 143, 144  
 Degree · 9  
 Delete · 33, 53, 55, 56, 59, 83, 84, 96, 112  
 Device · 140

Display · 34, 43, 115, 122, 123, 124, 125, 126, 128, 132, 134  
 Done · 49, 67, 93  
 Draw · 18

---

### **E**

Edit · 23, 24, 48, 91, 102, 135, 142  
 Editor · 11, 13, 19, 23, 31, 41, 75  
 EHD · 58, 129, 130  
 Enable · 9, 31, 32, 54, 55  
 EOS · 139  
 Execute · 9, 28, 31, 37, 39, 41, 42, 103, 107  
 Export · 1, 4, 6, 18, 52, 112, 113, 125

---

### **F**

Failed · 49, 56, 59, 67, 69, 85, 92  
 Firmware · 1, 6, 103, 104, 110, 142, 144  
 Frequency · 9, 24, 40, 41, 49, 125

---

### **G**

GPIB · 1, 2, 6, 8, 100, 101, 135, 137, 139, 140, 141, 145, 146

---

### **H**

Help · 5

---

### **I**

IDN · 12, 74  
 Import · 4, 18, 19, 52, 76, 108, 112, 113, 125  
 Input · 45, 49, 52, 64, 82, 83, 85, 92, 98  
 Interface · 4, 88, 135, 137, 139

---

## **K**

Keyboard · 60  
kFactor · 105

---

## **L**

LCD · 11, 114, 135, 137, 142  
Limits · 48, 58, 129, 130, 131  
Local · 43, 60, 114, 115  
Lock · 9, 11, 49, 60  
Lockout · 114

---

## **M**

Manual Mode · 28, 31, 44, 63, 74, 105, 106, 107  
Measurement · 88, 123, 125, 146  
Message · 82  
Meter · 7, 9, 11, 52, 56, 58, 60, 72, 73, 76, 79, 101,  
122, 123, 125, 126, 128, 132, 133, 134  
Mirror · 18

---

## **N**

New · 52, 78, 83, 94, 95, 98

---

## **O**

Objective · 47, 90, 98  
Output · 9, 11, 12, 13, 25, 26, 27, 30, 31, 32, 35, 36,  
37, 40, 41, 42, 44, 45, 52, 54, 55, 76, 78, 118, 120,  
121

---

## **P**

Pan · 18, 20, 35, 109, 126  
Pass · 53, 82, 85, 96  
Paste · 17, 33, 52, 95  
PON · 76  
Power · 4, 5, 19, 45, 46, 48, 58, 63, 91, 94, 98, 102,  
123, 130, 142  
Preview · 1, 6, 107, 118, 121

Probe · 43, 112, 114, 142  
Program · 26, 44, 107, 115, 118, 121

---

## **Q**

Query · 43, 112, 114, 143, 144

---

## **R**

Ramp · 28, 32, 40, 44, 114  
Refresh · 11, 27, 103, 122, 123, 126, 128

---

## **S**

Sample · 133  
Script · 52, 62, 63, 100  
Select · 16, 17, 18, 35, 53, 96, 106, 112, 137  
Select all · 17  
Selection · 16  
Sense · 12  
Show · 17, 50, 93  
Single · 45, 64, 68  
Start · 4, 24, 46, 50, 70, 93, 98, 132, 133, 135, 138  
Stop · 45, 49, 50, 56, 78, 79, 85, 92, 93, 134  
Synthesis · 123

---

## **T**

THD · 17, 58, 129, 130  
Transformer · 12, 56, 137  
Transient · 31, 32, 33, 34, 36, 37, 45, 49, 52, 53, 55,  
75, 76, 77, 78, 79, 80, 81, 82, 92, 119, 120, 144

---

## **U**

User · 45, 49, 52, 64, 79, 82, 83, 85, 86, 87, 92, 98,  
106, 110

---

## **V**

Visa · 65, 145

Volts · 9, 33, 40, 56, 58, 128, 131, 137, 143  
Vrms · 13, 14, 33, 41, 58, 125

---

## W

Waveform · 11, 13, 15, 16, 18, 19, 23, 24, 31, 41, 58,  
60, 75, 126

---

## Z

zoom · 15, 17, 18, 108, 109, 120