

Operation Manual

ADF Series™ – Rev 1.1.5

P/N 160670-10

ADF Series® Programmable AC Power Source

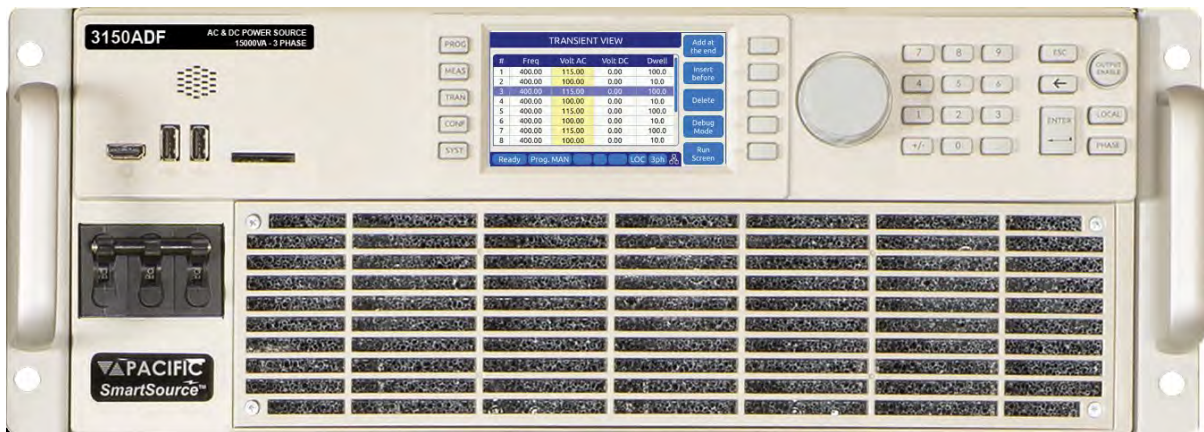

PACIFIC POWER SOURCE **PACIFIC POWER SOURCE**

Worldwide Supplier of Precision Programmable Power

Copyright © 2024, Pacific Power Source, Inc. (PPS) • All Rights Reserved • No reproduction without written authorization from PPS.

GENERAL DISCLAIMER

Pacific Power Source, Inc. reserves the right to revise this documentation and to make changes in content from time to time without obligation on the part of Pacific Power Source, Inc. to provide notification of such revision or change. This publication may include technical or other inaccuracies or typographical errors. Furthermore, changes are periodically added to the information herein; these changes will be incorporated in new editions of the publication. Pacific Power Source, Inc. may make improvements and/or changes in the operation, features, functions and/or technical specifications described in this publication at any time.

Table of Contents

1	Contact Information	12
2	Safety & Warranty Information	13
2.1	Limited Warranty	13
2.2	Service and Spare Parts Limited Warranty	13
2.3	Safety Information.....	13
2.4	Safety Notices	15
3	Product Overview	20
3.1	General Description.....	20
3.2	Product Features	20
3.3	Block Diagram	21
3.4	Controller Description	22
3.5	Measurement Read-back	22
3.6	Accessories Included (Ship Kit)	22
3.7	Remote Control Interfaces.....	22
3.8	Available Options.....	23
4	Technical Specifications	24
4.1	Single Chassis Models.....	24
4.2	Multiple Chassis Models	24
4.3	AC Output Mode	25
4.3.1	Temporary Current Overload	27
4.3.2	AC Voltage and Current Output Charts.....	28
4.3.3	Option V - Extended AC Voltage Ranges – Supplemental specs.....	29
4.4	DC Output Mode (Requires Option D)	31
4.5	Protection Modes.....	31
4.6	Metering	32
4.7	AC Input	33
4.8	Dimensions & Weight	33
4.9	Environmental	34
4.10	Safety & Regulatory.....	34
4.11	Digital Interfaces.....	35
4.12	Auxiliary I/O	36
4.13	Transformer Output Voltage Range (T Option)	38
4.13.1	Available T Option Rating Versions.....	38
4.13.2	Technical Specifications 400V Range	39
5	Unpacking and Installation	40
5.1	Inspection	40
5.2	Lifting and Carrying Instructions.....	40
5.3	Verify Correct AC Input Line Voltage.....	42
5.4	AC Input Connections.....	43
5.5	Grounding Requirements	46
5.5.1	Chassis Ground Connection Required.....	46
5.5.2	Output Neutral Grounding.....	47
5.6	AC Input Circuit Breaker	47
5.7	Bench Use	48
5.8	Rack Mounting.....	48
5.9	Airflow	48
5.10	Sound Levels	49
5.11	Cleaning.....	50
5.12	Air Intake Filter Removal and Cleaning	50
5.12.1	Air Filter Removal	51

5.12.2	Filter Cleaning	51
5.12.3	Air Filter Installation	51
5.13	Liquids	51
5.14	Load Connections	52
5.14.1	Output Wiring and Recommended Wire Sizing	52
5.14.2	Three Phase Wye or Split Phase Load Output Connection – 3150ADF	53
5.14.3	Three Phase Delta Load Output Connection – 3150ADF Only	56
5.14.4	Single Phase Load Output Connection – 1150ADF Only	59
5.14.5	External Voltage Sense Connections	61
5.14.6	Powering Up	63
5.14.7	In Case of Malfunction	63
5.15	Cabinet Systems Installation	64
5.15.1	Standard Cabinet Sizes	64
5.15.2	Tools Required	64
5.15.3	Dimensions	65
5.15.4	Cabinet System AC Input Connections	68
5.15.5	Recommended AC Input Wire Strip Lengths	69
5.15.6	Cabinet System AC Input Neutral	69
5.15.7	Cabinet System Grounding	70
5.15.8	Recommended AC Output Wire Strip Lengths	71
5.15.9	Cabinet Load Connections	71
5.16	ADF Cabinet Systems Turn ON and turn OFF Procedures	72
5.16.1	Cabinet Power Turn ON using Circuit Breakers	72
5.16.2	Cabinet Power Turn OFF using Circuit Breakers	72
5.17	Cabinet System Options	74
5.17.1	-OCS: Output Control Switch Option	74
5.18	Interface Options	74
5.18.1	Rear Panel Connector Locations	74
5.18.2	USB Device Interface	75
5.18.3	GPIB Device Interface	75
5.18.4	LAN Interface	75
5.18.5	System Interface Bus Connectors	77
5.19	Multi-Unit Parallel Operation	77
5.19.1	Load Connections on Parallel Systems	77
5.19.2	Parallel System Bus Connection	78
5.19.3	Master / Master Paralleling	79
5.20	Multi-Cabinet Parallel Operation Guidelines	80
5.20.1	Output Wiring	80
5.20.2	System Grounding	80
6	Front Panel Operation	82
6.1	Front Panel Layout	82
6.1.1	Keyboard Buttons	83
6.1.2	Shuttle Knob	84
6.1.3	PC Monitor Output	84
6.1.4	USB Host Ports	84
6.1.5	SD Card Memory Slot	84
6.2	OUTPUT ENABLE Button	85
6.2.1	OUTPUT State Indication	85
6.2.2	Energy Savings Modes	85
6.2.3	Output On Response Times	85
6.3	Menu Keys	86
6.4	PROG – PROGRAM & MEASUREMENTS Screen	87
6.4.1	Power On Settings	88
6.4.2	PROGRAM Output Parameters	89
6.4.3	Three Phase Models – Phase Linked or Unlinked Data Entry	89
6.4.4	Phase Rotation / Phase Sequence	90

6.4.5	Direct Data Entry - Presets	91
6.4.6	Customizing Output Programming Preset Soft Key Values	92
6.4.7	Changing Shuttle Programming Resolution	92
6.4.8	PROGRAM & MEASUREMENTS Soft Keys.....	93
6.4.9	Peak Current Protection Minimum Setting.....	95
6.4.10	Sine Waveform	96
6.4.11	AUTO RMS Function – Steady State	97
6.4.12	Option V - Extended AC Voltage Range Operation.....	98
6.5	MEAS – MEASUREMENTS Screens	101
6.5.1	Measurements Screen by Phase	101
6.5.2	Three Phase Measurement Screen Soft Keys	102
6.5.3	Individual Phase Measurement Screen Soft Keys	104
6.5.4	Measurement Screen Soft Keys	105
6.5.5	Measurement Data Logging	106
6.6	TRAN- TRANSIENTS Screens	107
6.7	CONF – CONFIGURATION Screens	108
6.7.1	UNIT CONFIGURATION Screens	110
6.7.2	USER LIMITS SETTINGS Screen	113
6.7.3	RAMP TIME & SLEW RATE SETTINGS Screen.....	114
6.7.4	PROGRAM MEMORY Screen	116
6.7.5	CSC CONFIGURATION Screen	117
6.7.6	USER PRESETS Screen.....	118
6.8	SYST – SYSTEM Screens.....	120
6.8.1	SYSTEM MENU 1	121
6.8.2	SYSTEM MENU 2	121
6.8.3	ERROR / EVENT QUEUE Screen	122
6.8.4	FAULT INFORMATION Screen.....	122
6.8.5	INTERFACE Screen	123
6.8.6	UNIT INFORMATION Screen	136
6.8.7	CONNECTED UNITS Screen	137
6.8.8	SCPI CONSOLE.....	138
6.8.9	SYSTEM SETTINGS Screen.....	139
6.8.10	MEMORY MANAGEMENT Screen.....	140
6.8.11	CALIBRATION MENU Screen.....	145
6.8.12	FIRMWARE UPDATE Screen	146
6.8.13	REMOTE SUPPORT Screen.....	147
7	Rear Panel, Connectors and Protection	148
7.1	OUTPUT Terminals	148
7.1.1	Output Power Connector Rating and Isolation.....	148
7.1.2	Wire Size	149
7.1.3	Connecting a UUT.....	149
7.2	External Voltage Sense Input Terminals	150
7.2.1	External Voltage Sense Connector Rating and Isolation	151
7.2.2	Load Connection without External Voltage Sense	151
7.2.3	Load Connection with External Voltage Sense	151
7.3	Auxiliary I/O	152
7.3.1	Auxiliary I/O Functions	152
7.3.2	DB25 Connector AUX I/O Pin locations.....	153
7.3.3	I/O Signal Table by pin number	154
7.3.4	I/O Signal Table by Function	155
7.3.5	Dedicated Function Digital Inputs	156
7.3.6	External or Line Sync Input.....	159
7.3.7	Digital Output control signals.....	162
7.3.8	User Programmable Digital signals.....	165
7.3.9	Analog I/O Descriptions	167
7.3.10	12 DC Power Supply	169

7.3.11	RS232 Description	169
7.3.12	Front Panel Operation of AUX I/O Functions	170
7.4	System Interface Bus Connectors	177
8	Remote Control Programming.....	178
8.1	Overview	178
8.1.1	Programming Conventions and Notations	178
8.1.2	Command Terminators	179
8.2	Remote Control Command Descriptions by Subsystem	180
8.3	Calibration Commands.....	181
8.3.1	ADF Calibration Commands.....	181
8.3.2	UPC Specific commands.....	183
8.3.3	AUX I/O Interface Calibration Commands	183
8.4	Measurement Commands.....	184
8.4.1	Voltage Measurement Commands	184
8.4.2	Frequency Measurement Commands	185
8.4.3	Current Measurement Commands	185
8.4.4	Power Measurement Commands	186
8.4.5	Other Measurement Commands	188
8.4.6	Measurement Data Logging Commands	189
8.4.7	Measurement Resolution Setting Commands	192
8.5	Output Control Commands	194
8.6	Program Commands	199
8.6.1	Program Control Commands	199
8.6.2	Execution Commands	207
8.6.3	Memory Management Commands	208
8.7	Source Commands	211
8.7.1	Source Configuration Programming Commands.....	211
8.7.2	Voltage Programming Commands	215
8.7.3	Frequency Programming Commands	222
8.7.4	Current Programming Commands	223
8.7.5	Phase Programming Commands.....	226
8.7.6	Voltage Protection Programming Commands.....	227
8.7.7	Current Protection Programming Commands.....	229
8.7.8	Power Protection Programming Commands.....	231
8.7.9	Frequency Protection Programming Commands.....	237
8.8	Status Commands	237
8.9	System Commands.....	239
8.9.1	System Error Commands	239
8.9.2	System Information Commands.....	241
8.9.3	System Interface Soft Key Preset Commands.....	245
8.9.4	System Configuration Commands.....	249
8.9.5	Parallel System Commands	251
8.9.6	System Sanitization Commands	252
8.9.7	Communication LAN Commands	252
8.9.8	Communication Serial Port Commands	256
8.9.9	Communication USB Commands	257
8.9.10	Communication GPIB Commands	259
8.9.11	System Firmware Commands.....	260
8.9.12	System Remote Access Commands	261
8.9.13	Miscellaneous System Commands.....	264
8.9.14	System Import / Export Commands.....	265
8.9.15	System Regional Setting Commands.....	266
8.9.16	Miscellaneous Remote Restart Commands.....	266
8.10	Auxiliary I/O System Commands	268
8.10.1	System Analog & Digital IO Commands	268
8.10.2	SOURce:SYNChronize Commands.....	282

8.10.3	PROGram:TRANSient Triggers Commands	285
8.10.4	AUX I/O Calibration Commands	287
8.11	IEEE488.2 Common Commands	291
8.12	Status and Events Registers	295
8.12.1	Status Byte Register (STB)	295
8.12.2	Status Event Register (ESR)	297
8.12.3	SCPI Status Registers	298
9	USB Driver Installation.....	300
9.1	Overview	300
9.2	Installation	300
10	LAN Interface Configuration	302
10.1	Overview	302
10.2	Web Browser Interface	302
10.3	Access Control	304
10.3.1	Browser Access Control	305
10.3.2	Front Panel Access Control	309
10.4	Web Browser Interface	310
10.5	Available Web Interface Menu Tree	310
10.6	Home Screen	311
10.6.1	SCPI Console Command Line Interface	311
10.6.2	Status Byte Display	312
10.6.3	Browser Status Bar	312
10.6.4	Operation Manual PDF.....	312
10.7	Source Control Screens	313
10.7.1	Program	314
10.7.2	Protections.....	315
10.7.3	Program Memory.....	316
10.7.4	SCPI Script	317
10.8	Measurement Screens	319
10.8.1	Monitor	320
10.8.2	Real-Time Plot.....	321
10.8.3	V/I Plot.....	322
10.8.4	Data Logger.....	323
10.9	Configuration Screens	324
10.9.1	Unit Settings.....	325
10.9.2	User Limits & Presets	326
10.9.3	Ramp Time & Slew Rate.....	327
10.10	System Screens.....	328
10.10.1	Error/Event Queue	329
10.10.2	Fault List	330
10.10.3	Error/Event List.....	331
10.10.4	Interface Setup	332
10.10.5	Access Control	333
10.10.6	Digital & Analog IO's.....	334
10.10.7	Remote Interface (Virtual Front Panel)	337
10.10.8	Unit Information.....	338
10.10.9	Connected Units	339
10.10.10	Memory Browser	340
10.10.11	Calibration.....	341
10.10.12	Remote Support	342
10.10.13	Import / Export	342
10.10.14	Firmware Update	343
10.10.15	Sanitize and Reboot.....	344
10.11	Additional Functions.....	344
10.11.1	Sharing Options – FTP & SAMBA	344

11 Calibration	345
11.1 Calibration Interval	345
11.2 Closed Case User Calibration	345
11.3 Equipment Required	345
11.4 Calibration Procedures.....	346
11.4.1 Voltage Calibration - Offset.....	346
11.4.2 Current Calibration - Offset.....	347
11.4.3 Voltage Calibration - Gain	348
11.4.4 Current Gain Calibration Setup Diagrams	349
11.4.1 Current Calibration Load Values.....	350
11.4.2 Current Calibration - Gain	351
11.4.3 Exit Calibration Mode.....	351
12 Warnings & Error Messages	352
12.1 Preface	352
12.2 Errors & Warnings Messages in Numeric Order.....	352
13 Service and Maintenance	375
13.1 Warnings.....	375
13.2 Authorized Service Centers.....	376
14 ModBus TCP Server / Slave Interface.....	377
14.1 TCP ModBus TCP Interface	377
14.2 Modbus TCP Register Tables	377
14.3 ModBus Control Example using Python.....	391
15 CE MARK Declaration of Conformity.....	392
Index	393

Table of Tables

Table 3-1: Included Accessories	22
Table 3-2: Remote Control Interfaces	22
Table 3-3: Available ADF Options	23
Table 5-1: AC Input Wire Size Table	44
Table 5-2: Remote Control Interface Connector Locations on Rear Panel (A Versions w GPIB)	74
Table 5-3: GPIB Interface Connector Pin Assignments	75
Table 6-1: Available Menu Keys.....	86
Table 6-2: Available Output Parameters on PROGRAM screen.....	89
Table 6-3: Changing Programming Resolution	92
Table 6-4: PROGRAM screen soft keys	94
Table 6-5: ADF Series® Sine Waveform	96
Table 6-6: Three Phase Measurement Screen Soft Keys	103
Table 6-7: Individual Phase Measurement Screen Soft Keys	104
Table 6-6: Measurement Screen Soft Keys.....	105
Table 6-8: Available UNIT CONFIGURATION 1 screen soft keys	111
Table 6-9: Available UNIT CONFIGURATION 2 screen soft keys	112
Table 6-10: Available USER LIMITS SETTINGS screen soft keys	113
Table 6-11: Available RAMP TIME & SLEW RATE SETTINGS screen soft keys	115
Table 6-12: Available SLEW RATE SETTINGS screen soft keys	117
Table 6-13: Available CSC CONFIGURATION screen soft keys	117
Table 6-14: Available USER INTERFACE screen soft keys.....	125
Table 6-15: Available USER INTERFACE screen soft keys.....	128
Table 6-16: Available ETHERNET INTERFACE SETUP screen soft keys	130
Table 6-17: Available SERIAL INTERFACE SETUP screen soft keys	131
Table 6-18: Available USB INTERFACE SETUP screen soft keys	132
Table 6-19: Available GPIB INTERFACE SETUP screen soft keys	133
Table 6-20: Available UNIT INFORMATION screen soft keys.....	136
Table 6-21: Available PARALLEL UNITS screen soft keys	137
Table 6-22: Available SYSTEM SETTINGS screen soft keys	140
Table 6-23: Available CALIBRATION MENU screen soft keys.....	146
Table 6-24: Available FIRMWARE UPDATE screen soft keys	146
Table 6-25: Available LOGGING TOOL screen soft keys.....	147
Table 7-1: Auxiliary I/O DB25 Connector Pin numbers and Signals by DB25 pin number.....	154
Table 7-2: Auxiliary I/O DB25 Connector Pin numbers and Signals by Signal Name	155
Table 7-3: Default Analog Output Functions	168
Table 7-4: AUX I/O Analog Input assignable Commands.....	171
Table 7-5: AUX I/O Digital Output assignable Events or Conditions.....	174
Table 8-1: Available SCPI Command Subsystems	180
Table 8-2: Mandatory IEEE488.2 Common Commands	291
Table 8-3: Status Byte Register (STB)	295
Table 8-4: Status Event Register (ESR).....	297
Table 10-1: Supported Script Entries.....	317
Table 11-1: Required Calibration Equipment	345
Table 11-2: Setup for Voltage Offset Calibration	346
Table 11-3: Calibration Load Values by Model and Phase Mode	350
Table 12-1: Warnings and Error Messages Listing.....	374

Table of Figures

Figure 2-1: EMI AC Input Filter Residual Voltage Check after disconnecting AC Mains power	18
Figure 3-1: ADF Series® Basic Block Diagram	21
Figure 4-1: Output Voltage distortion into full R Load as a function of Frequency.....	26
Figure 4-2: Current Overload vs. Time.....	27
Figure 4-3: AC Mode Voltage/Current range, 1150ADF Model.....	28
Figure 4-4: AC Mode Voltage/Current range, 3150ADF Model per Phase	28
Figure 4-5: Extended AC Voltage/Current Range, 1150ADF Model	30
Figure 4-6: Extended AC Voltage/Current Range, 3150ADF Model per phase.....	30
Figure 4-7: Dimension Drawing ADF Series® 15KW Model	34
Figure 4-8: Rack Mount Chassis for 15kVA Transformer Option.....	38
Figure 4-1: Model 5L18-36 VI Curve	40
Figure 5-2: Exploded view of ADF unit packaging	41
Figure 5-3: Rear Panel Layout.....	45
Figure 5-4: AC Input Terminal Block - Rear Panel.....	45
Figure 5-5: Grounding Floating Neutral Output	47
Figure 5-6: Air Intake Filter Removal.....	50
Figure 5-7: Air Intake Filter and Filter Panel.....	51
Figure 5-8: Three phase Wye or Split phase Load Output Connections – Internal Voltage Sense.....	54
Figure 5-9: Three phase Wye or Split phase Load Output Connections – External Voltage Sense	55
Figure 5-10: Three phase Delta Load Output Connections – Internal Voltage Sense	57
Figure 5-11: Three phase Delta Load Output Connections – External Voltage Sense.....	58
Figure 5-12: 1150 ADF Single Phase Shorting Adaptor assembly.....	59
Figure 5-13: Single phase Load Output Connections.....	60
Figure 5-14: ADF A Version External Voltage Sense Connector	62
Figure 5-15: ADF Cabinet Dimensions	65
Figure 5-16: Dimension Drawing 18 U Cabinet	65
Figure 5-17: Dimension Drawing 28 U Cabinet	66
Figure 5-18: Dimension Drawing 36 U Cabinet	67
Figure 5-19: ADF Cabinet AC Input Connection Terminal Block TB1	69
Figure 5-20: Output Power Terminal Block TB2	71
Figure 5-21: ADF Cabinet System Power ON and OFF Sequences.....	73
Figure 5-22: ADF Series® Rear Panel Layout.....	76
Figure 5-23: Parallel Mode Bus Connections using parallel bus cable	79
Figure 5-24: Multi-Cabinet Parallel Configuration Output Wiring - 3 Phase	81
Figure 6-1: ADF Series® Front Panel View	82
Figure 6-2: PROGRAM Screen.....	89
Figure 6-3: Three Phase AC mode Default Phase Rotation	90
Figure 6-4: Three Phase AC mode Reversed Phase Rotation	91
Figure 6-5: Enable Vac extended operating range to 312Vac	99
Figure 6-6: Three Phase Measurement Screens.....	101
Figure 6-7: Single Phase Measurement Screens for Phase A and B	101
Figure 6-8: USER LIMIT SETTINGS Screen	113
Figure 6-9: RAMP TIME & SLEW RATE SETTINGS Screen.....	114
Figure 6-10: PROGRAM MEMORY screen.....	116
Figure 6-11: CSC CONFIGURATION screen	117
Figure 6-12: SYSTEM MAIN MENU 1	120

Figure 6-13: SYSTEM MAIN MENU 2	120
Figure 6-14: ERROR & EVENT QUEUE Screen	122
Figure 6-15: FAULT INFORMATION screen	122
Figure 6-16: INTERFACE SETUP Screen	123
Figure 6-17: ETHERNET INTERFACE SETUP Screen	129
Figure 6-18: SERIAL INTERFCE SETUP Screen	131
Figure 6-19: USB INTERFACE SETUP Screen	132
Figure 6-20: USB INTERFACE SETUP Screen	133
Figure 6-21: REMOTE INHIBIT Setup Screen.....	134
Figure 6-22: UNIT INFORMATION Screen	136
Figure 6-23: PARALLEL UNITS Screen	137
Figure 6-24: SYSTEM SETTINGS Screen.....	139
Figure 6-36: MEMORY MANAGMENT Screen.....	140
Figure 6-26: CALIBRATION MENU Screen.....	145
Figure 6-27: FIRMWARE UPDATE Screen	146
Figure 6-28: REMOTE SUPPORT Screen.....	147
Figure 6-29: Remote Support REPORT Screen.....	147
Figure 7-1: Rear Panel AUX I/O DB25 Connector Location.....	152
Figure 7-2: DB25 Connector AUX I/O Pin Locations	153
Figure 7-3: External Trigger Input Timing	158
Figure 7-4: External Sync Input Pulses.....	160
Figure 7-5: External Sync Input Sync Status Indication	161
Figure 7-6: External Sync Input Sync Lost Status Indication.....	161
Figure 7-7: Transient Trigger Output Pulse	163
Figure 7-8: Function Strobe Output Pulse	163
Figure 7-9: Phase A Zero Phase Sync Output Pulse	164
Figure 8-1: Energy Saving Modes and Output Commands State Diagram	194
Figure 8-2: OUTP:ZERO Command Ramp and Dwell settings.....	198
Figure 8-3: Status Byte Logical Model	296
Figure 8-4: Standard Event Register (ESR) Model	297
Figure 8-5: SCPI Status Registers Model.....	299
Figure 9-1: PPST USB Drivers visible in Windows Device Manager	301
Figure 10-1: LXI Web Server Home Screen	303
Figure 10-2: ACCESS CONTROL Dialog Screen	305
Figure 10-3: Remote Access Control Request Dialog	306
Figure 10-4: Remote Access Control IP Filter screen.....	307
Figure 11-1: Voltage Calibration Equipment Setup – 1 or 3 Phase Mode – Phase A.....	348
Figure 11-2: Current Calibration Equipment Setup – 3 Phase Mode – Phase A.....	349
Figure 11-3: Current Calibration Equipment Setup – 1 Phase Mode	350

1 Contact Information

AMERICA / CANADA

Pacific Power Source

2802 Kelvin Avenue, Suite 100

Irvine, CA 92614

USA

Phone: +1(949) 251-1800

Fax: +1 (949) 756-0756

Email: support@pacificpower.com

EUROPE

Pacific Power Source Europe, GmbH.

Binzigstraße 21

D-77876 Kappelrodeck

Germany

Phone: +49(0)7842-99722-20

Fax: +49(0)7842-99722-29

Email: info@pacificepower.eu

CHINA

PPST Shanghai Co. Ltd.

4 floors , building 2, No. 2185 Lai Fang Road

Jiu Ting Town, Song Jiang District

Shanghai 201615

Phone: +86-21-6763-9223

Fax: +86-21-5763-8240

Email: support@pacificepower.comWeb: <http://pacificpower.com>

2 Safety & Warranty Information

2.1 Limited Warranty

Pacific Power Source, Inc. (PPS) warrants each unit to be free from defects in material and workmanship. For the period of two (2) years from the date of shipment to the purchaser, PPS will either repair or replace, at its sole discretion, any unit returned to the PPS factory in Irvine, California or one of its designated service facilities. It does not cover damage arising from misuse of the unit or attempted field modifications or repairs. This warranty specifically excludes damage to other equipment connected to this unit.

Upon notice from the purchaser within (30) days of shipment of units found to be defective in material or workmanship, PPS will pay all shipping charges for the repair or replacement. If notice is received more than thirty (30) days from shipment, all shipping charges shall be paid by the purchaser. Units returned on debit memos will not be accepted and will be returned without repair.

This warranty is exclusive of all other warranties, expressed or implied.

2.2 Service and Spare Parts Limited Warranty

PPS warrants repair work to be free from defects in material and workmanship for the period of ninety (90) days from the invoice date. This Service and Spare Parts Limited Warranty applies to replacement parts or to subassemblies only. All shipping and packaging charges are the sole responsibility of the buyer. PPS will not accept debit memos for returned power sources or for subassemblies. Debit memos will cause return of power sources or assemblies without repair.

This warranty is exclusive of all other warranties, expressed or implied.

2.3 Safety Information

This chapter contains important information you should read BEFORE attempting to install and power-up PPS Equipment. The information in this chapter is provided for use by experienced operators. Experienced operators understand the necessity of becoming familiar with, and then observing, life-critical safety and installation issues. Topics in this chapter include:

- Safety Notices
- Warnings
- Cautions
- Preparation for Installation
- Installation Instructions

Make sure to familiarize yourself with the **SAFETY SYMBOLS** shown on the next page. These symbols are used throughout this manual and relate to important safety information and issues affecting the end user or operator.

SAFETY SYMBOLS



Direct current (DC)



Alternating current (AC)



Both direct and alternating current



Three-phase alternating current



Protective Earth (ground) terminal



On (Supply)



Off (Supply)



Fuse



Caution: Always consult this manual when you see this warning symbol marking in order to familiarize yourself with the nature of the potential hazard and actions to be taken to avoid them.



Caution, risk of electric shock

2.4 Safety Notices

SAFETY SUMMARY

The following general safety precautions must be observed during all phases of operation, service, and repair of this instrument. Failure to comply with these precautions or with specific warnings elsewhere in this manual violates safety standards of design, manufacture, and intended use of the instrument. Pacific Power Source assumes no liability for the customer's failure to comply with these requirements.



WARNING: CLASS 1 INSTRUMENT

This product is a Safety Class 1 instrument (provided with a protective earth terminal). The protective features of this product may be impaired if it is used in a manner not specified in the operation instructions.



AVERTISSEMENT: APPAREIL CLASSE 1

Cet produit est un appareil Classe 1 (avec terre de protection). Les dispositifs de sécurité de ce produit peuvent être altérés si le produit est utilisé d'une manière non spécifiée dans le manuel d'utilisation.



WARNING: ENVIRONMENTAL CONDITIONS

This instrument is intended for indoor use in an installation category II, pollution degree 2 environments only. It is designed to operate at a maximum relative humidity of 80% for temperatures up to 31 °C, decreasing linearly to 50 % relative humidity at 40 °C and at altitudes of up to 2000 meters. Refer to the specifications tables for the ac mains voltage requirements and ambient operating temperature range.



AVERTISSEMENT: CONDITIONS ENVIRONNEMENTALES

Cet appareil est destiné à une utilisation intérieure dans une installation de catégorie II, degré de pollution 2. Il est conçu pour fonctionner sous humidité relative maximale de 80%, pour des températures allant jusqu'à 31°C, diminuant linéairement jusqu'à 50% d'humidité relative à 40°C et à des altitudes allant jusqu'à 2000 m. Se reporter aux tableaux de spécifications pour les exigences en terme de tension secteur et plage de température ambiante de fonctionnement.

**CAUTION: BEFORE APPLYING POWER**

Verify that the product AC input specifications noted on the model tag matches the available utility line voltage and frequency.

**ATTENTION: AVANT DE METTRE SOUS TENSION**

Vérifier que les spécifications de tension d'alimentation de l'équipement notées sur l'étiquette sont bien compatibles avec la tension et fréquence secteur disponibles.

**SAFETY NOTICE: GROUNDING**

This product is a Safety Class 1 instrument (provided with a protective earth terminal). To minimize shock hazard, the instrument chassis or cabinet must be connected to an electrical safety ground. The instrument must be connected to the AC power supply mains through a properly rated three phase power cable with protective earth (L1-L2-L3-E). Any interruption of the protective (grounding) conductor or disconnection of the protective earth terminal will cause a potential shock hazard that could result in personal injury.

This instrument may be equipped with a line filter to reduce electromagnetic interference and must be properly grounded to minimize electric shock hazard. Operation at line voltages or frequencies in excess of those stated on the model type plate may cause leakage currents in excess of 5.0 mA peak.

**REGLE DE SECURITE: MISE A LA TERRE**

Ce produit est un équipement de Classe 1 (muni d'une borne de mise à la terre). Pour minimiser le risque de choc électrique, le châssis de l'appareil ou de l'armoire/rack doit impérativement être relié à une terre de sécurité électrique. L'appareil doit être branché sur le secteur d'alimentation électrique à courant alternatif par un câble d'alimentation triphasé approprié avec terre de protection (L1-L2-L3-PE). Toute interruption de la mise à la terre de protection ou de déconnexion de la borne de terre causera un risque de choc électrique qui pourrait entraîner des blessures.

Cet appareil peut être équipé d'un filtre secteur pour réduire les interférences électromagnétiques et doit être correctement mis à la terre afin de minimiser le risque de choc électrique. Le fonctionnement sous tensions et fréquences supérieures à celles indiquées sur l'étiquette peut provoquer des courants de fuite de plus de 5,0 mA peak.

**WARNING: DO NOT OPERATE IN AN EXPLOSIVE ATMOSPHERE**

Do not operate the instrument in the presence of flammable gases or fumes.

**AVERTISSEMENT: NE PAS UTILISER SOUS ATMOSPHERE
EXPLOSIVE**

Ne pas faire fonctionner l'appareil en présence de gaz ou vapeurs inflammables.

**WARNING: KEEP AWAY FROM LIVE CIRCUITS**

Operating personnel must not remove instrument covers. Component replacement and internal adjustments must be made by qualified service personnel. Do not replace components with power cable connected. Under certain conditions, dangerous voltages may exist even with the power cable removed. This includes the AC Input terminals which may have residual voltage due to internal charged capacitors that have no discharge path. To avoid injuries, always disconnect power, discharge circuits and remove external voltage sources before touching components.

After disconnecting grid power, ALWAYS wait at least 1 minute, then use a Digital Voltmeter (DMM) in VDC Mode to check for any residual DC voltage from each Line terminal to the Chassis ground stud to check for safe voltage levels (< 5 Vdc) before touching the unit or any terminal blocks or pins.

**AVERTISSEMENT: TENIR A L'ECART DE CIRCUITS SOUS TENSION**

Les utilisateurs ne doivent pas retirer les capots de l'appareil. Le remplacement des composants et les ajustements internes doivent être et ne peuvent être effectués que par un personnel qualifié. Ne pas remplacer les composants avec câble d'alimentation connecté sur le secteur. Sous certaines conditions, des tensions dangereuses peuvent exister même avec le câble d'alimentation retiré. Ceci inclut les bornes d'entrée CA qui peuvent avoir une tension résiduelle due aux condensateurs chargés internes. Pour éviter les blessures, toujours débrancher le câble d'alimentation, décharger les circuits électriques et débrancher les sources de tension externes avant de toucher les composants.

Après avoir débranché l'alimentation du réseau, attendez TOUJOURS au moins 1 minute, puis utilisez un voltmètre numérique (DMM) en mode VDC pour vérifier toute tension CC résiduelle de chaque borne de ligne sur le plot de masse du châssis pour vérifier les niveaux de tension sécurisés (<5 Vcc) avant de toucher l'unité ou des borniers ou des broches.

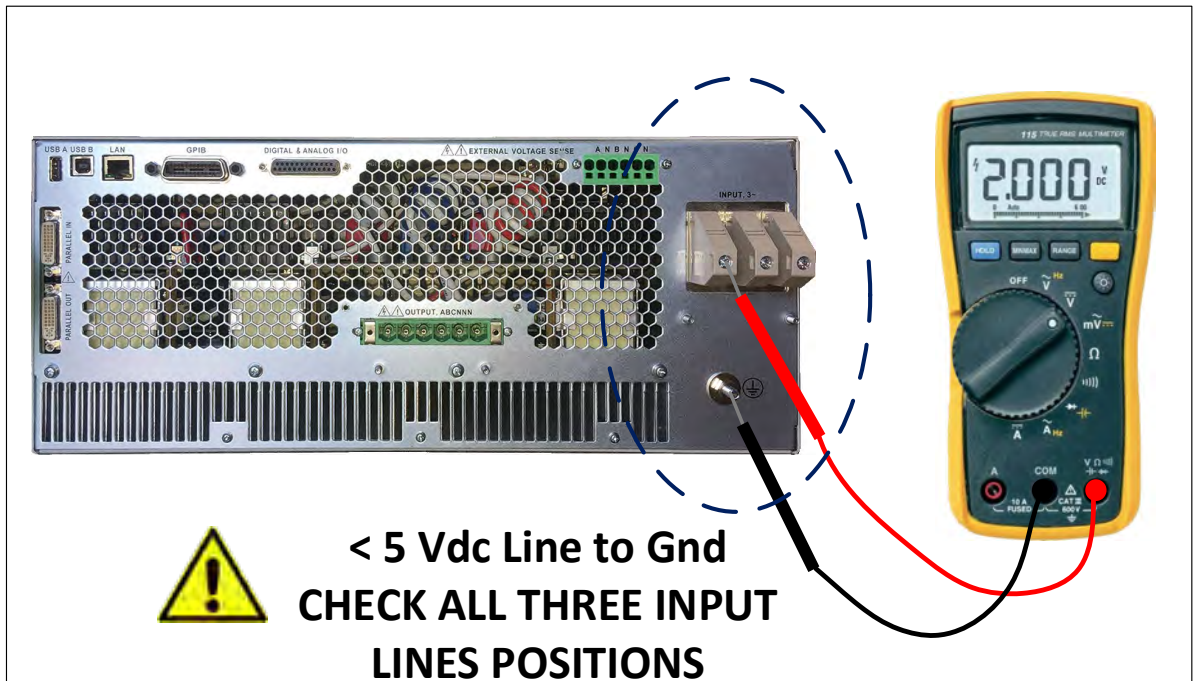

Figure 2-1: EMI AC Input Filter Residual Voltage Check after disconnecting AC Mains power

**WARNING: DO NOT SUBSTITUTE PARTS OR MODIFY INSTRUMENT**

Because of the danger of introducing additional hazards, do not install substitute parts or perform any unauthorized modification to the instrument. Return the instrument to a Pacific Power Source Sales and Service Office for service and repair to ensure that safety features are maintained.

Instruments that appear damaged or defective should be made inoperative and secured against unintended operation until they can be repaired by qualified service personnel.

**AVERTISSEMENT: NE PAS REMPLACER DE PIÈCES ET DE COMPOSANTS – NE PAS MODIFIER L'ÉQUIPEMENT**

En raison d'introduction de dangers supplémentaires, ne pas installer des pièces de rechange et ne pas effectuer de modification de l'équipement non autorisés. Retourner l'appareil à un bureau de ventes et services Pacific Power Source pour le service et la réparation afin d'assurer le maintien des caractéristiques de sécurité. Les appareils qui semblent endommagés ou défectueux doivent être rendus inopérants et protégés contre le fonctionnement involontaire jusqu'à ce qu'ils puissent être réparés par un personnel qualifié.

**CAUTION: INSTRUMENT LOCATION**

Do not position this instrument in such a way as to block easy access to any mains disconnect device or in any way that makes it difficult to operate the mains disconnect device.

**ATTENTION: EMPLACEMENT DE L'APPAREIL**

Ne pas placer cet appareil de manière à bloquer l'accès facile à tout débranchement du réseau électrique ou d'une façon qui rende difficile l'opération de débranchement du réseau électrique.

3 Product Overview

This chapter provides an overview of the PPS ADF Series® programmable power sources. It introduces the reader to general operating characteristics of these power supplies.

3.1 General Description

The Pacific Power Source (PPS) ADF Series® power source is designed to provide accurate, stable and clean AC power to a unit under test. The PPS ADF Series® power supply can be operated from the front panel (manual mode) or using RS232, USB, LAN (Ethernet) or GPIB remote control.

The performance of the ADF Series® power source models is detailed in section 4, “Technical Specifications”. Maximum voltage, current and power capability depends on the specific model. This manual covers standard ADF Series® models. Modified units are generally shipped with a manual addendum as a supplement to this manual. The manual addendum covers specific modifications from the standard model(s).

3.2 Product Features

The following key characteristics apply to all ADF Series® models;

- Programmable electronic power source.
- AC output mode
- Single or Three / Split phase output models available.
- Fully remote control of all settings and metering read back.
- Constant power mode single-voltage range eliminates the need to switch between high and low voltage ranges.
- Over voltage, over current and over power protection.
- External voltage sense.
- Auxiliary I/O – Analog and Digital.
- Digital Interfaces for Remote Control

3.3 Block Diagram

The block diagram of the fully digital power source is shown in Figure 3-1 below. It shows the key functional blocks for the three phase 3150ADF models. The 1150ADF uses a similar architecture but has a single higher power DC/AC inverter output stage.

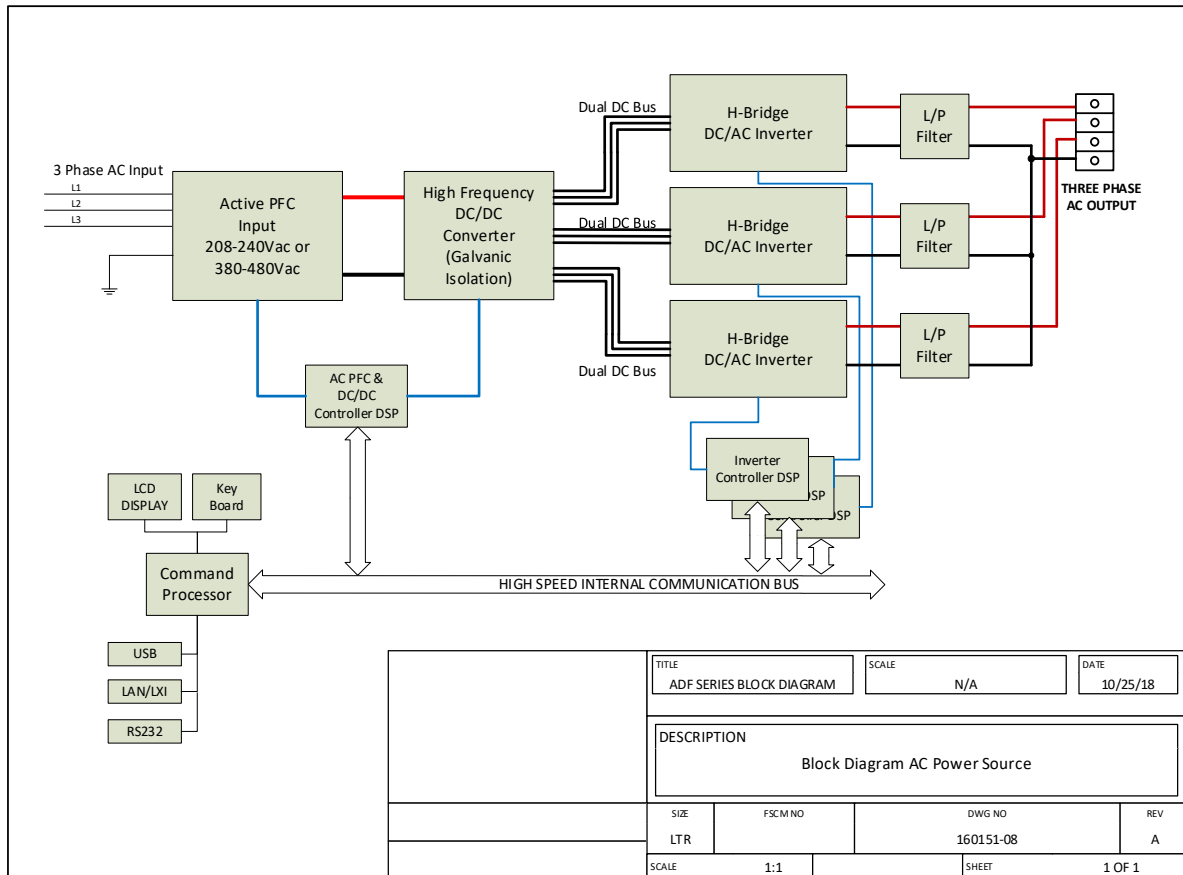

Figure 3-1: ADF Series® Basic Block Diagram

3.4 Controller Description

The ADF Series® power supplies use an advanced command processor that communicates with the internal power stages using several high speed communication buses and with the outside world through a variety of interfaces. One of these interfaces is the front panel keyboard and LCD display which supports manual operation of the AC power source.

The command processor handles all user inputs as well as any analog or digital input provided to the unit. All power stages are operated autonomously and take input from the main command processor. For larger power configurations consisting for multiple chassis, the master unit command processor communicates to all chassis that are connected on the master/auxiliary interconnect bus.

3.5 Measurement Read-back

The voltage, frequency and current limit settings of the AC power source can be set from the front panel or over any of the available digital remote control interfaces. During operation, the AC source output voltage, frequency, current and power can be read back for each of the available output phases.

3.6 Accessories Included (Ship Kit)

The following accessories are included with each ADF Series® AC power source. If one or more of these is missing upon incoming inspection of the product, please contact Pacific Power Source customer service.

Item	Quantity
Operation Manual in PDF Format	Available from PPS website
Mating Output Connector	1 per unit
Certificate of Conformance	1
Output Shorting Adaptor (Single Phase ADF units only)	1 per unit

Table 3-1: Included Accessories

3.7 Remote Control Interfaces

Following remote control interfaces are supported.

Remote Control Interfaces	
USB Interface	Standard
RS-232 Interface	Standard
LAN Interface	Standard
AUX I/O	Standard
GPIB	Standard

Table 3-2: Remote Control Interfaces

3.8 Available Options

The following options can be ordered at the time of original purchase to the ADF Series Power Sources.

Option Designation	Description	Notes
D	DC Output Mode Option	
F	Extended Frequency Range Option	
M	Single Phase Output Mode	Requires 3 Phase ADF
O	Output Control Switch	
T	Output Transformer for 400Vac Range	External Chassis
V	Extended AC Voltage Range	

Table 3-3: Available ADF Options

ADF Model Number Encoder:

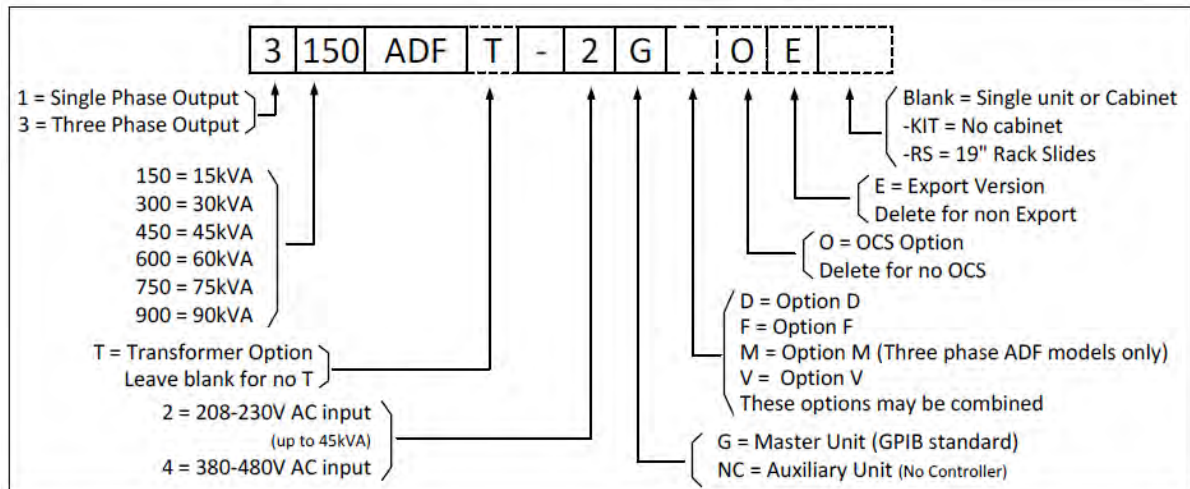

Note: For field upgrades of certain options, contact factory for details. This may require returning your unit to an authorized service center for retrofit. Some options may not be retrofittable.

4 Technical Specifications

Technical specifications shown here apply at an ambient temperature of 25° C ± 5° C.

4.1 Single Chassis Models

Single Phase Models

MODEL	No. Outputs	Rated Power	Voltage Range AC	Current	No. Chassis
190ADF ¹	1 Phase	9 kW	300 V rms	75.0 A rms	1
1150ADF	1 Phase	15 kW	300 V rms	125.0 A rms	1

Note 1: 9KVA models not available in all markets

Three Phase Models

MODEL	No. Outputs	Rated Power	Voltage Range AC	Current / Phs	No. Chassis
390ADF ¹	3 Phase, Split Phase	9 kW	300 V rms	25 A rms	1
3150ADF	3 Phase, Split Phase	15 kW	300 V rms	41.7 A rms	1

Note 1: 9KVA models not available in all markets

4.2 Multiple Chassis Models

Multi chassis model configurations consist of a single master unit and one or more slave units connected through a high-speed parallel bus. Each unit requires its own three-phase AC input and must be turned on at the front panel using its individual circuit breaker. This avoids massive inrush current at power up of the system as each unit can be turned on one at a time. Multi chassis systems are installed in a suitable 19" cabinet from the factory with a common AC input terminal block and a single phase or three phase common output terminal block. The same model is also available as a kit (-KIT post-fix) for installation into an end-user provided cabinet. No input or output wiring is provided with these kits.

Single Phase Models

MODEL	No. Outputs	Rated Power	Voltage Range AC	Current	No. Chassis
1300ADF (-KIT)	1 Phase	30 kW	300 V rms	250 A rms	2
1450ADF (-KIT)	1 Phase	45 kW	300 V rms	375 A rms	2

Three Phase Models

MODEL	No. Outputs	Rated Power	Voltage Range AC	Current / Phs	No. Chassis
3300ADF (-KIT)	3 Phase, Split Phase	30 kW	300 V rms	83.3 A rms	2
3450ADF (-KIT)	3 Phase, Split Phase	45 kW	300 V rms	125.0 A rms	3
3600ADF (-KIT)	3 Phase, Split Phase	60 kW	300 V rms	166.7 A rms	4
3750ADF (-KIT)	3 Phase, Split Phase	75 kW	300 V rms	208.3 A rms	5
3900ADF (-KIT)	3 Phase, Split Phase	90 kW	300 V rms	250.0 A rms	6

4.3 AC Output Mode

AC OUTPUT	
Voltage	
AC Range	0 - 300 V L-N rms / 0 - 520V L-L rms
Extended Voltage Range ¹ (Option V)	0 - 333 V L-N rms / 0 – 576 V L-L rms, see Note 1
Programming Resolution	0.01 V
Accuracy	± 0.25% F.S.
Waveform	Sine wave
DC Offset	< 20 mV
Harmonic Distortion ² (Vthd) (Full, Resistive Load)	< 100 Hz < 0.3% 100 Hz to 500Hz < 0.5% Option F: 500 to 1000 Hz < 1.0% > 1000 Hz < 1.5% See V THD Chart at bottom of next page
Output Noise (DC – 300 kHz)	< 150 mV rms
Load Regulation	± 0.02% (CSC Mode on)
Line Regulation	± 0.1% for 10% Line Change
External Voltage Sense	External Sense, max. voltage drop 5% FS.
Voltage Slew Rate	At least 1.0 V/us
Isolation	550 Vrms
Frequency	
Range	45.00 – 500.0 Hz
Extended Frequency Range (Option F)	15.00 – 1200.0 Hz
Programming Resolution ³	0.01 Hz
Accuracy	± 0.01%
Current Limit	
Range ⁴	See model tables, Figure 4-3 and Figure 4-4. Values shown are supported for any period of time.
Current Overload	Available 30% Current overload for up to 2.0 seconds when enabled. See Figure 4-2.
Crest Factor	2.5:1 @ 41.67 to 6.3:1 @ 16.67 (104Apk / phase for 3150ADF, 312Apk for 1150ADF)
Programming Resolution	0.01 A rms
Accuracy	± 0.5% F.S.
Modes	Constant Current Mode or Output Trip
Phase Angles (3 Phase Models)	
Phase Offsets ⁵	A = 0°, B = 240°, C = 120
Accuracy	± 0.35°

Note 1: Extended operation to 333V L-N / 576V L-L supported in Three and Split Phase mode up to 3.3kVA per phase for frequency range 45Hz ~ 800Hz with Option F. Some specifications exceptions apply. Requires Option V.

Note 2: Refer to Figure 4-1, "Output Voltage distortion into full R Load as a function of Frequency" on next page.

AC OUTPUT

Note 4: FREQUENCY PROGRAM RESOLUTION FOR EXPORT MODELS WITH OPTION E (-4GE, -2GE):

Per U.S.A. Bureau of Industry and Security, ECCN 3A225, frequency control is limited to no better than 0.2% at frequencies of 600 Hz. or more for unrestricted export products. To meet that requirement, frequency programming in all -2GE and -4GE ADF models has three resolution ranges, which round the frequency to the nearest increment, as defined in the table below.

Frequency Resolution for Export Models

<u>Range</u>	<u>Resolution</u>
1.00 - 99.99 Hz	0.01 Hz
100-599.9 Hz	0.1 Hz
600 - 999 Hz	2.0 Hz
1000 - 1200 Hz	5.0 Hz

Note 5: Refer to Voltage / Current ratings tables.

Note 6: Actual output phase angles may be slightly different from programmed values for highly unbalanced three phase load conditions, in particular at high frequency due to amplifier phase shift differences.

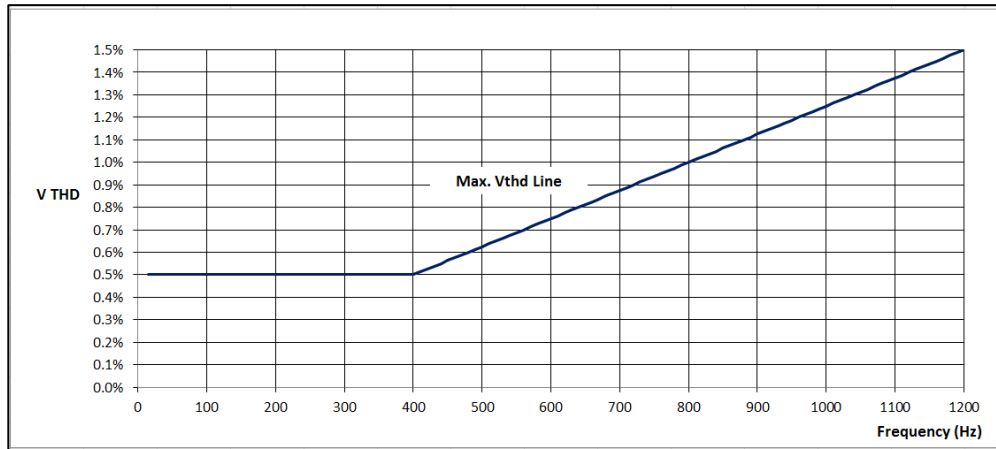
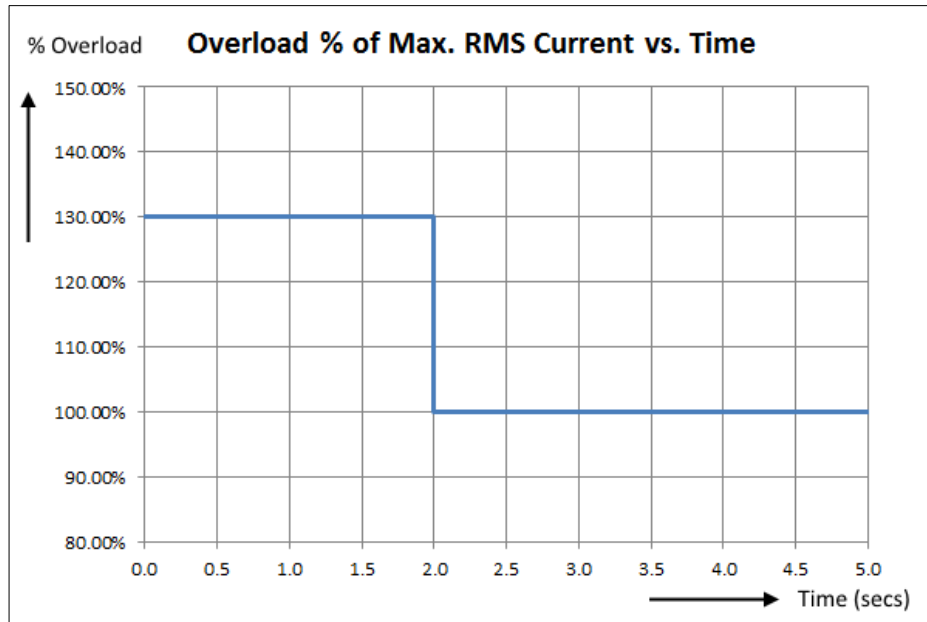

Figure 4-1: Output Voltage distortion into full R Load as a function of Frequency

4.3.1 Temporary Current Overload



4.3.2 AC Voltage and Current Output Charts

AC VOLTAGE RANGES

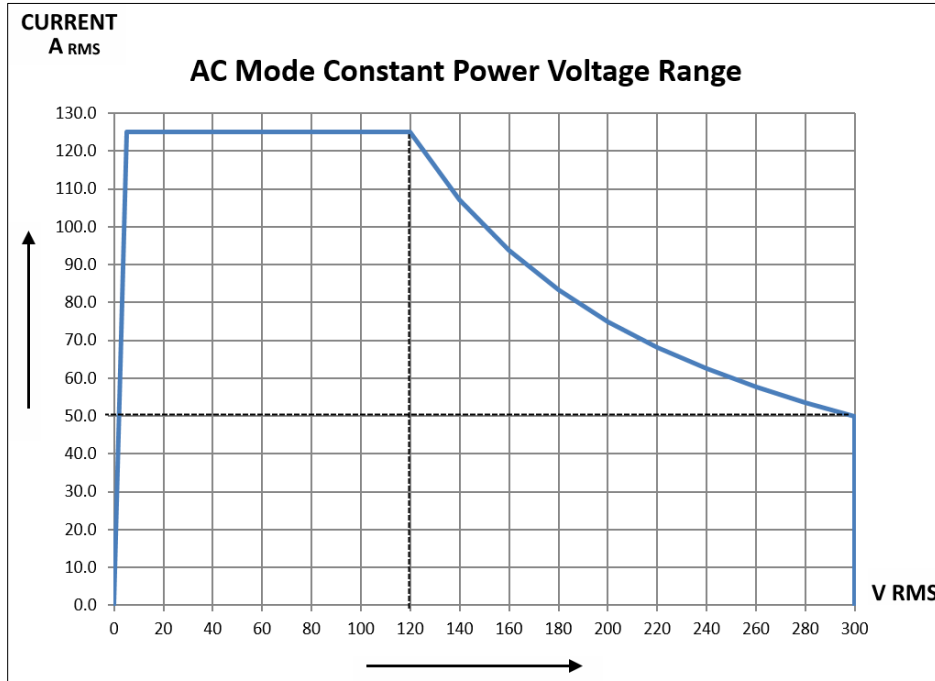

Figure 4-3: AC Mode Voltage/Current range, 1150ADF Model

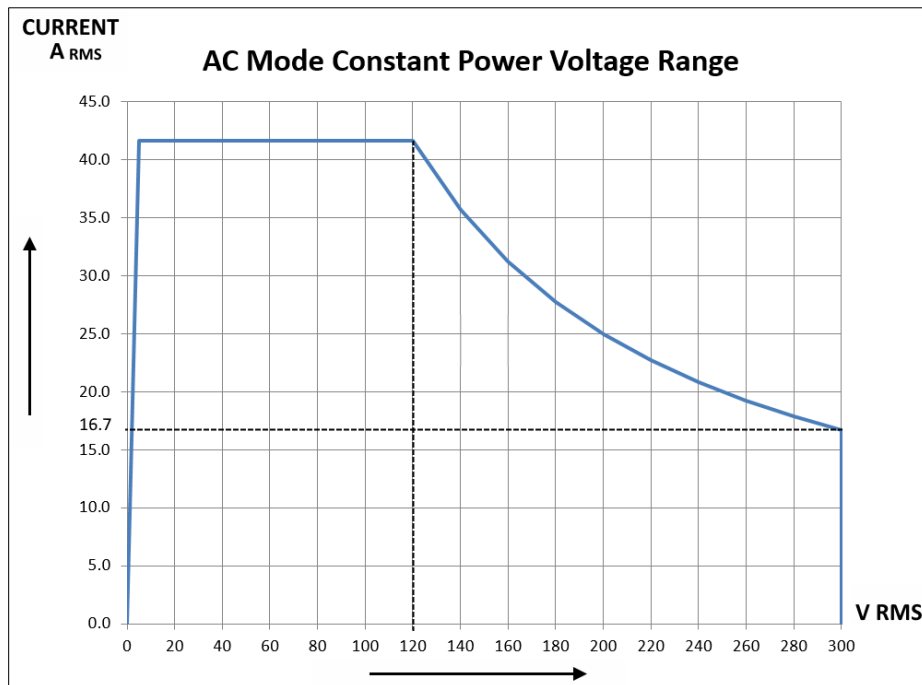

Figure 4-4: AC Mode Voltage/Current range, 3150ADF Model per Phase

4.3.3 Option V - Extended AC Voltage Ranges – Supplemental specs

The ADF-2V / ADF-4V provides three extended voltage ranges, 0 through 2. The maximum programmable Vrms AC limits for each of these extended ranges are:

- Range 0 312V_{LN}
- Range 1 320 V_{LN}
- Range 2 333 V_{LN}

Range 0 is activated by setting the AC voltage user limit to a value between 300 and 312. More details on extended range 0 are provided in section 6.4.11, page 98.

Range 1 and 2 must be enabled using a bus command before they can be activated in a similar way. Refer to

Note: For voltage limits higher than 312V L-N, this mode must be enabled first. See “[SOURCE:]VOLTage:EXTend” command in section 8.7.2 on page 215.

The following specification adjustments apply for each extended range mode.

Range 0: up to 312V

- Standard THD specs apply only from 45-100Hz
- Only supported in three phase mode
- Maximum output power is 3kW per phase

Range 1: up to 320V

- Max. current limited to 35Arms/phase
- Limits maximum frequency set point to 800Hz
- Does not guarantee THD specification but designed to have THD < 1.0% at Pout<9kW

Range 2: up to 333V

- Max. current limited to 35Arms/phase
- Limits maximum frequency set point to 800Hz
- Does not guarantee THD. Control loop may saturate at V > 320, giving a THD of 2-3% at 333V/9kW

These power and current restrictions are reflected in the charts below for reference.

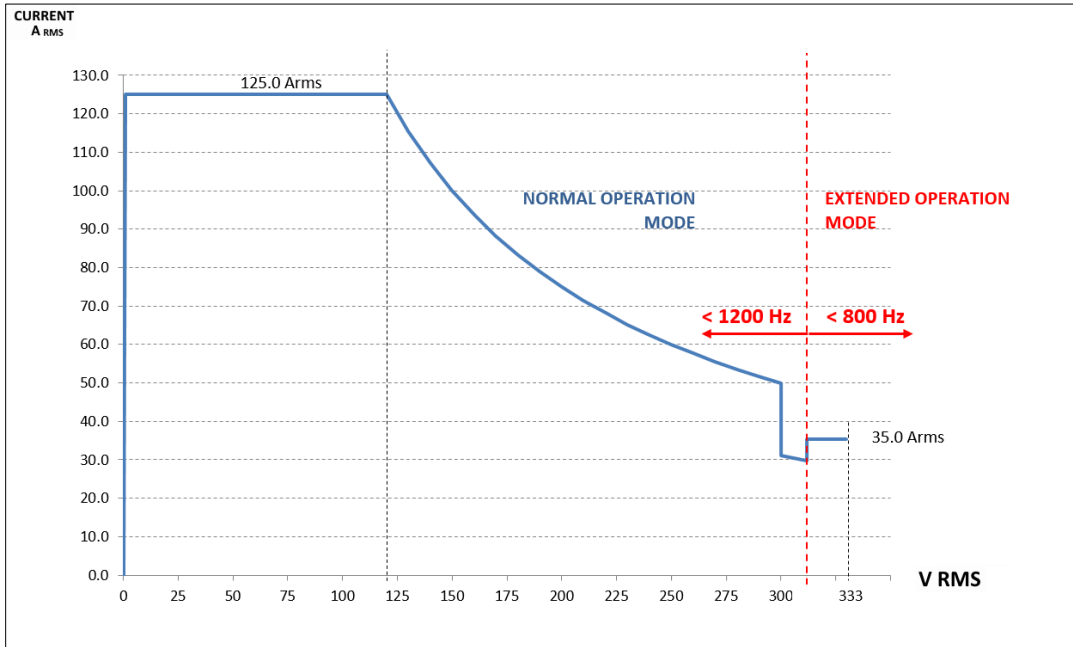

Figure 4-5: Extended AC Voltage/Current Range, 1150ADF Model

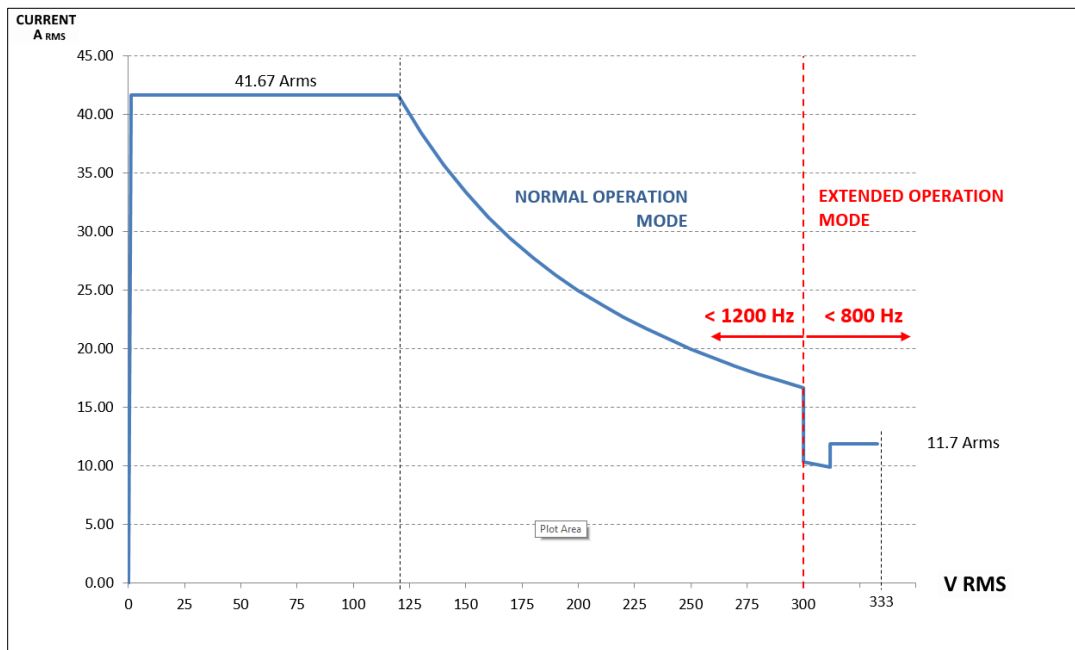

Figure 4-6: Extended AC Voltage/Current Range, 3150ADF Model per phase

4.4 DC Output Mode (Requires Option D)

DC OUTPUT	
Voltage	
Range	0 – 425 Vdc
Programming Resolution	0.01 V
Accuracy	± 0.25% F.S.
Noise & Ripple	< 150 mV rms
Load Regulation	± 0.02%
Line Regulation	± 0.1% for 10% Line Change
External Voltage Sense	External Sense, max. voltage drop 5% FS.
Voltage Slew Rate	At least 3.0 V/us (DC Mode)
Current Limit	
Programming Resolution	0.01 Adc
Accuracy	± 0.5 Adc
Modes	Constant Current Mode or Output Trip

MODEL	Phase Mode	Rated Power	DC Voltage Range	Max. DC Current 3/2 Phase Mode	Max. DC Current 1 Phase Mode	Form Factor
1150ADF-xGD	1 Phase	15 kVA	0 ~ ±425 Vdc	n/a	62.5 Adc	4U Chassis, Rackmount
3150ADF-xGD	3 / 2 Phase	15 / 10 kVA		21.0 Adc	n/a	
1300ADF-xGD	1 Phase	30 kVA		n/a	125.0 Adc	Fully wired 28U Cabinet power system
3300ADF-xGD	3 / 2 Phase	30 / 20 kVA		41.7 Adc	n/a	
1450ADF-xGD	1 Phase	45 kVA		n/a	187.5 Adc	
3450ADF-xGD	3 / 2 Phase	45 / 30 kVA		62.5 Adc	n/a	Fully wired 36U Cabinet power system
3600ADF-xGD	3 / 2 Phase	60 / 45 kVA		83.5 Adc	n/a	

4.5 Protection Modes

PROTECTION	
Protection Modes	Over Current fold-back or trip
	Progr. Peak Current Limit
	Power fold-back or trip
	Apparent Power fold-back or trip
	Over Voltage trip
	Over Temperature
OVP Range	0 - 105% Vmax
AC Input Voltage	Over and Under Voltage

4.6 Metering

MEASUREMENTS	
Voltage AC ⁽¹⁾	
Range	L-N: 0 – 350 V rms; L-L: 0 – 600 V rms
Resolution	0.01 V
Accuracy	± 0.25% F.S.
Frequency (AC Mode Only)	
Range	15 – 1200Hz
Resolution	0.01 Hz
Accuracy	± 0.1% Reading
Current AC ⁽²⁾	
Range	See model table in section 4.1 or 0
Resolution	0.01 A
Accuracy	± 0.5% F.S.
Peak Current	
Range	4 x RMS current
Resolution	0.01 A
Accuracy	± 1.5% F.S.
Crest Factor	
Range	1.00 – 5.00
Resolution	0.01
Accuracy	± 2.0% F.S.
True Power ^(2,)	
Range	See model table in section 4.1 or 0
Resolution	0.01 W
Accuracy	± 1.5% F.S.
Apparent Power ⁽²⁾	
Range	See model table in section 4.1 or 0
Resolution	0.01 VA
Accuracy	± 1.5% F.S.
Power Factor ⁽³⁾	
Range	0.00 – 1.00
Resolution	0.01
Accuracy	± 0.5% F.S.
Voltage DC (Requires Option D)	
Range	0- 440 Vdc
Resolution	0.1 V
Accuracy	± 0.25% F.S.
Current DC (Requires Option D)	
Range	See model table in section 4.1 or 0
Resolution	0.01 A
Accuracy	± 0.5% F.S.

Note 1: AC Voltage measurement accuracy shown for Line to Neutral measurements. Line to Line voltage measurements are calculated based on VLN and phase angles and are < 0.5% F.S. and valid only for sinusoidal voltage waveforms with low levels of distortion and under balanced three phase load conditions.

Note 2: Measurement Accuracies for Current and Power apply for load currents of 2.0 A or more.

Note 3: For Power level above 100 W

4.7 AC Input

AC INPUT		9kVA	15kVA
Frequency Range			
AC Input Frequency	47 - 63 Hz		
Connection	4 Wire, (L1, L2, L3 and PE)		
-208 Input Version (-2)			
Input Voltage Range	208 Vac – 240 Vac ± 10%		
Nominal Phase Current @ 208V 3 ϕ	33 A rms	51 A rms	
Max. Rated Phase Current, 3 ϕ	37 A rms	55 A rms	
Peak Inrush Current ¹	< 1.5 x I _{rms}		
Input Power Factor	> 0.9		
Efficiency	> 85 %		
Internal Line Fuses -2 NOT USER SERVICEABLE			
Type	FUSE, SEMICONDUCTOR,22X58MM		
Rating	80A,600VAC		
-400 / -480 Input Version (-4)			
Input Voltage Range	380 Vac – 480 Vac ± 10%		
Nominal Phase Current @ 380V 3 ϕ	18 A rms	27 A rms	
Max. Rated Phase Current	20 A rms	30 A rms	
Nominal Phase Current @ 480V 3 ϕ	14 A rms	23 A rms	
Max. Rated Phase Current	16 A rms	28 A rms	
Peak Inrush Current ²	< 1.5 x I _{rms}		
Input Power Factor	> 0.9		
Efficiency	> 85 %		
Internal Line Fuses -4 NOT USER SERVICEABLE			
Type	FUSE, SEMICONDUCTOR,22X58MM		
Rating	63A,600VAC		

NOTE: For models consisting of multiple chassis, power input ratings apply to each chassis.

4.8 Dimensions & Weight

DIMENSIONS & WEIGHT		9 kVA	15 kVA
Dimensions			
Height	7.0" / 178 mm / 4U		
Width	17.0" / 432 mm – w/o rack handles 19.0" / 483 mm - with attached rack handles		
Depth	25.0" / 635 mm		
Weight			
Net	111.2lbs. / 50.4 kg		
Shipping	130 lbs. / 59 kg		

NOTE: For models consisting of multiple chassis, multiply weight and height by the number of chassis.

See dimension drawing. 3D Step Models Available on request.

¹ For nominal line input voltage

² For nominal line input voltage

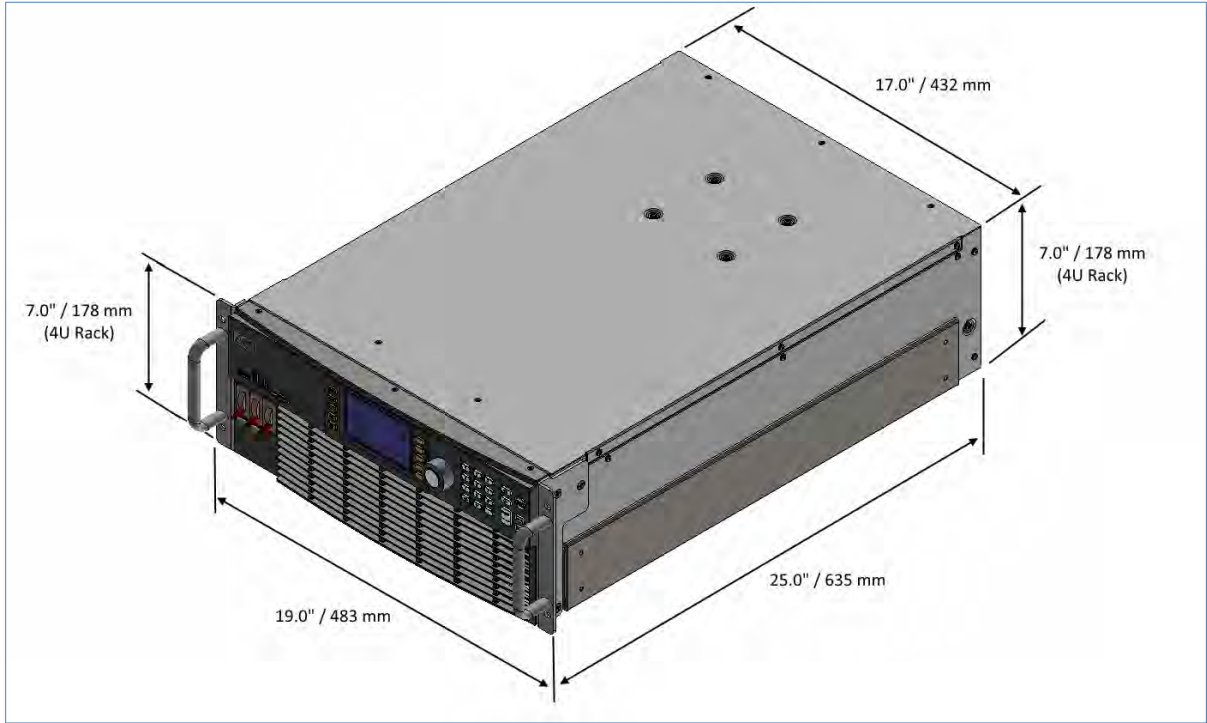

Figure 4-7: Dimension Drawing ADF Series® 15KW Model

4.9 Environmental

ENVIRONMENTAL	
Cooling	Fan Cooled
Audible Noise (at 1 meter)	Standby: 46 dBA Full power: 85 dBA typical
Operating Temperature	0 to 40 °C / 32 to 104 °F
Storage Temperature	-20 to 70 °C / -4 to 158 °F
Humidity	< 80%, non-condensing for temperatures up to 31 °C decreasing linearly to 50 % relative humidity at 40 °C
Altitude (max.)	2000 m / 6560 feet

4.10 Safety & Regulatory

SAFETY & REGULATORY	
Safety Standard	EN 61010-1:2010 (Edition 3)
EMC Emissions	EN 55011:2009+A1:2010
EMC Immunity	EN 6100-4-2, -3, -4, -5, -6, -8, -11
Product Category	EN61326-1:2010 (Measurement, Laboratory and Control Equipment)
Approvals	CE Mark, NTRL Nemko US/Canada

4.11 Digital Interfaces

USB	
USB Standard	USB 2
USB Class	
Front Panel	Type A USB Host (2)
Connector	Type A, standard
Rear Panel	Type A USB Host (1) Type B USB Device (1)
Connector Types	

RS232	
Baud rate:	9600, 14400, 19200, 38400, 57600, 62500, 115200
Parity:	O = Odd = uneven parity E = Even = even parity N = None = no parity bit
Number of data bits:	7 or 8
Number of stop bits:	1 or 2
Handshake:	Xon/Xoff
Signal Levels:	
Inputs (RxD)	Maximum input voltage: ± 25 V Input Impedance: 5 k Ω typical Switching thresholds: $V_H < -3$ V, $V_L > +3$ V
Outputs (TxD)	Output voltage (at $R_{LOAD} > 3$ k Ω): min ± 5 V, typical ± 5.4 V Output Impedance: < 300 Ω min., 10 M Ω typical in power off state Short circuit current: Typ. ± 35 mA typical

Ethernet	
Protocol	Ethernet TCP/IP, 100Mb/1000Mb
Connector	RJ45
Webserver	Built-in
LXI Compliance	Core, version 1.4

GPIB	
IEEE Standard	IEEE488.1, IEEE488.2 (2003 incl., NI HS488) IEC 60488-1, IEC 60488-2 (2004)
IEEE Functions Supported	SH1, AH1, T6, L3, SR1, RL1, DC1, DT1
Connector	Amphenol 24 pin, Micro ribbon connector. Rear Panel Set screws: M3.5x0.6 metric threads.

4.12 Auxiliary I/O

The Auxiliary I/O functions are only available on all ADF Series power source models.

The following technical specifications apply to the Auxiliary I/O functions.

AUX I/O SIGNAL SPECIFICATIONS	
Digital Inputs	
Input Signals	Remote Inhibit, External Trigger Input, Phase Sync, User Inputs (3)
Voltage Levels	Logic low: $V_{in} < 0.4\text{ V}$ Logic High: $V_{in} > 2.0\text{ V}$
Input Impedance	10 k Ω
Absolute max. voltage	12V
Digital Outputs	
Output Signals	<i>Open Collector (0.5A max. protection):</i> FORM Relay Control, Transformer Relay Control Note: DO1 and DO2 are TTL outputs with 5.2V output and 200 Ω output impedance. Into a 5k Ω load, the output voltage is ~5V. Note: DO3 and DO4 are open-drain outputs with internal pull-up of 1k to 5.5V with a diode protection. At no load, these outputs will measure 5.5V. With a 5k Ω impedance, these outputs will measure ~4.6V. <i>TTL Level:</i> Relay State/Function Strobe / Trigger Out Phase Reference (sync output) User programmable outputs (2)
Voltage Levels @ 0.4 mA	Logic low: $V_{in} < 0.4\text{ V}$ Logic High: $V_{in} > 4.6\text{ V}$
Output impedance	200 Ω
Analog Inputs	
Signals	Analog Inputs (4)
Voltage Range	-10V – 10V
Accuracy	$\pm 0.1\%$ F.S.
Sampling Rate	10 Hz or 10 times/sec
Open Circuit Level	2 ~ 3 % of F.S. if analog input is left floating (no connection)
Input Impedance	5 k Ω
Absolute max. voltage	12V
Analog Outputs	
Signals	Analog Outputs (4)
Voltage Range	0V – 10V
Accuracy	$\pm 0.1\%$ F.S. (with 5 k Ω load or higher)
Update Rate	10 Hz or 10 times/sec
Output Impedance	5 k Ω
Power	
Output	12.0 Vdc
Accuracy	$\pm 0.1\%$ Vdc
Max. Current	0.5 Adc
RS232	
Signals	Tx, Rx
Handshake	Xon/ Xoff
Baud rates	9600 – 460800 bps

Auxiliary I/O Signal Protection Information and Recommendations

- All the signals on the auxiliary I/O DB25 port have double insulation with respect to high voltage. They are safe to touch (SELV) and safe to connect to any other equipment.
- These signals are referenced to earth, so any data acquisition card or equipment used to control the power source should be referenced to the same earth as the power source. For the power source unit, earth is its chassis.
- If the controlling computer connected to the power source is connected to an earth with different potential - this can happen when using different outlets or AC utility circuits - , that voltage difference can damage low-signal circuits.
- Analog outputs cannot be negative and cannot be higher than 5V. Any DAQ card or instrument used to monitor/read these outputs must have a sufficient input voltage range.
- In general, it is recommended to limit signal input voltages with series resistors and clamping diodes in case the “source” can generate a voltage higher than the maximum allowed by the analog inputs of the power source. See relevant specification on the previous page.

4.13 Transformer Output Voltage Range (T Option)

If more than 332Vac L-N is required in three-phase mode, the 400V Transformer option may be added to an ADF power source. This option provides an additional 400Vac L-N AC only voltage range. The standard 300Vac L-N voltage range remains available as the output transformer for this option is bypassed when not in use.



Figure 4-8: Rack Mount Chassis for 15kVA Transformer Option

4.13.1 Available T Option Rating Versions

The Transformer option is available in several power levels to match the power source configuration. The following transformer option ratings are available. Note that ADF models configured for a Transformer option are designated by an “ADFT” model designation.

ADFT Models	Transformer Rating
3150ADFT	Rack Mount 19” Chassis, 4U (7”) height. Rated for 15kVA max. ,0 -400Vac _{LN} / 0 – 692Vac _{LL}
3300ADFT	Transformers are installed in 19” Cabinet Systems along with ADF power sources Rated to 30kVA max ,0 -400Vac _{LN} / 0 – 692Vac _{LL}
3450ADFT	Transformers are installed in 19” Cabinet Systems along with ADF power sources Rated to 45kVA max, 0 -400Vac _{LN} / 0 – 692Vac _{LL}
3600ADFT	Transformers are installed in 19” Cabinet Systems along with ADF power sources Rated to 60kVA max, 0 -400Vac _{LN} / 0 – 692Vac _{LL}
For higher power configurations, contact factory	

4.13.2 Technical Specifications 400V Range

AC OUTPUT											
Voltage											
AC Only Range	0 - 400 V L-N rms / 0 - 692V L-L rms										
Programming Resolution	0.01 V										
Accuracy	± (0.25% + 0.25* f (kHz)) F.S.										
Constant Power Range	From 40% to 100% of Voltage Range: 160Vac L-N to 400Vac L-N										
External Voltage Sense	Automatically scaled for 400Vac Range										
Frequency											
Range	45.00 – 1000.0 Hz For models with –F Option: <ul style="list-style-type: none"> • Linear voltage derating from 45Hz to 15Hz • Linear current derating from 1000Hz to 1200Hz. 										
Programming Resolution ¹	0.01 Hz										
Accuracy	± 0.01%										
Current²											
Range	Available RMS Current per phase is scaled by transformer ratio. E.g. for 3150ADF, max current at 400Vac L-N is $(41.7 * \frac{1}{3}) = 31.27\text{Arms}$ in 3 Phase mode										
Current Overload	Available 30% Current overload for up to 2.0 seconds when enabled.										
<p>Note 1: FREQUENCY PROGRAM RESOLUTION FOR EXPORT MODELS (-4FE, -2FE): <i>Per U.S.A. Bureau of Industry and Security, ECCN 3A225, frequency control is limited to no better than 0.2% at frequencies of 600 Hz. or more for unrestricted export products. To meet that requirement, frequency programming in all ADF-xFE models has three resolution ranges, which round the frequency to the nearest increment, as defined in the table below.</i></p> <p>Frequency Resolution for Export Models</p> <table border="1"> <thead> <tr> <th>Range</th> <th>Resolution</th> </tr> </thead> <tbody> <tr> <td>15.00 - 99.99 Hz</td> <td>0.01 Hz</td> </tr> <tr> <td>100-599.9 Hz</td> <td>0.1 Hz</td> </tr> <tr> <td>600 - 999 Hz</td> <td>2.0 Hz</td> </tr> <tr> <td>1000 - 1200 Hz</td> <td>5.0 Hz</td> </tr> </tbody> </table>		Range	Resolution	15.00 - 99.99 Hz	0.01 Hz	100-599.9 Hz	0.1 Hz	600 - 999 Hz	2.0 Hz	1000 - 1200 Hz	5.0 Hz
Range	Resolution										
15.00 - 99.99 Hz	0.01 Hz										
100-599.9 Hz	0.1 Hz										
600 - 999 Hz	2.0 Hz										
1000 - 1200 Hz	5.0 Hz										
<p>Note 2: Refer to AC Mode Voltage / Current rating charts <i>Error! Reference source not found.</i> and <i>Error! Reference source not found.</i> on following pages.</p>											

MODEL	Phase Mode	Rated Power	T Voltage Range Vac L-N	Max. AC Current 3 Phase Mode	Max. AC Current 1 Phase Mode	Form Factor
1150ADFT	1 Phase	15 kVA	0-400 V	n/a	93.8 Arms	2x 4U Chassis, Rackmount
3150ADFT	3 Phase	15 kVA		31.3 Arms	n/a	
1300ADFT	1 Phase	30 kVA		n/a	187.6 Arms	Fully wired 28U Cabinet power system
3300ADFT	3 Phase	30 kVA		62.5 Arms	n/a	
1450ADFT	1 Phase	45 kVA		n/a	281 Arms	
3450ADFT	3 Phase	45 kVA		93.8 Arms	n/a	
3600ADFT	3 Phase	60 kVA		125.0 Arms	n/a	Fully wired 36U Cabinet power system

5 Unpacking and Installation

5.1 Inspection

The ADF Series® of AC power sources are carefully inspected before shipment. If instrument damage has occurred during transport, please inform Pacific Power Source' nearest sales and service office or representative.

All ADF models require three-phase AC input and are furnished with a compression terminal block for AC input. A suitable line cord and power disconnect is required (but not included) to connect these power supplies to the mains.

Refer to "check line voltage" to check the line voltage selection and fuse type.

Note: For input and output connections to ADF cabinet systems, refer to Section 5.15, "Cabinet Systems" starting on page 64.

5.2 Lifting and Carrying Instructions



WARNING

THIS UNIT IS HEAVY. Two persons are required to lift or carry this unit. DO NOT attempt to lift alone. DO NOT use the front panel rack handles alone to lift this unit. The unit must be supported in front and back when carrying.



AVERTISSEMENT

CET EQUIPEMENT EST LOURD. Deux personnes sont requises pour transporter ou soulever cet équipement. NE PAS tenter de soulever ou déplacer seul. NE PAS utiliser les poignées en face avant pour soulever l'appareil. L'équipement doit être pris en charge à l'avant et à l'arrière pour le transport.

This equipment weighs over 100 lbs. / 50 Kg and requires two persons to lift or carry. To remove the equipment from its packaging, use the provided handgrip openings on either side of the unit to lift the unit from its packaging and place it on a suitable surface that is rated to support the weight of the unit. Two persons are required to remove the ADF unit from its packaging, one on each long side of the box. Refer to Figure 5-2 for reference.

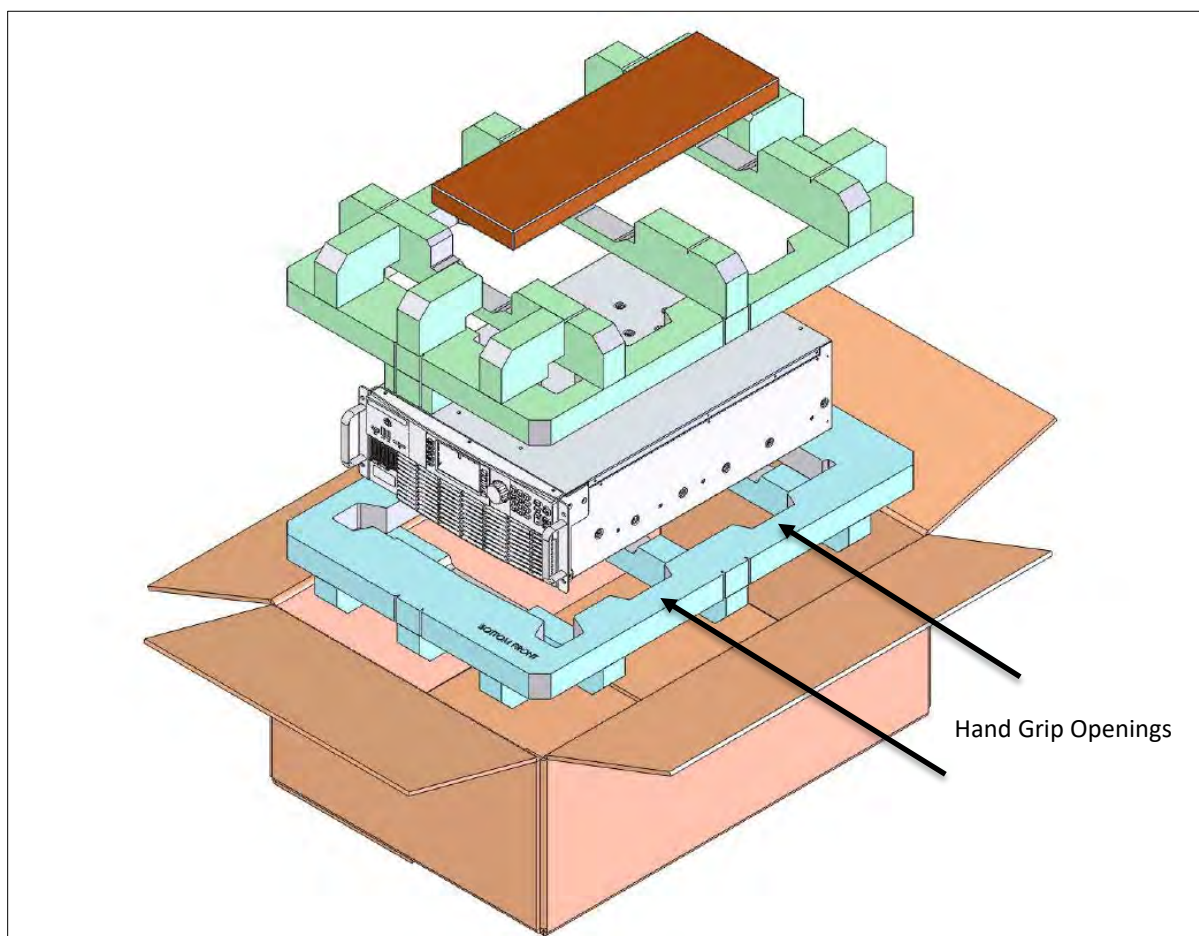

Figure 5-2: Exploded view of ADF unit packaging

If the unit is to be installed in an instrument rack, the straps may be removed. In that case, a suitable lift must be used to position the unit at the desired rack height and pushed in place using either rack slides or L-brackets (not included with the unit). The front panel handles may be used to pull or push the unit in or out of a rack space only.

Note: The front panel handles are not designed to carry the entire unit. It must be supported on front and back or both sides by two persons when being handled.

5.3 Verify Correct AC Input Line Voltage

The ADF Series® power supply can be ordered with a range of 3 phase AC input voltage configurations. Prior to connecting the AC power source to the local mains, it is important to check the type label on the unit to verify that its AC input configuration matches the local utility power.

Do not connect the power supply to the mains if the AC input voltage, phasing and frequency does not match.



WARNING

DO NOT CONNECT A 208 – 240 V AC INPUT ADF MODEL TO A 380V, 400V OR 480V OR HIGHER THREE PHASE UTILITY LINE VOLTAGE AS DAMAGE TO THE UNIT MAY OCCUR.

DO NOT CONNECT A 380 – 480 V AC INPUT ADF MODEL TO A 208V TO 240V THREE PHASE UTILITY LINE VOLTAGE AS THE UNIT WILL NOT OPERATE.



AVERTISSEMENT

NE PAS CONNECTER UNE 208-240 V AC ENTRÉE ADF MODÈLE À UN 380V, 400V OU 480V OU PLUS DE TROIS PHASES UTILITAIRE TENSION EN PANNE QUI PEUT SE PRODUIRE.

NE PAS CONNECTER UNE 380 - 480 V AC ENTRÉE ADF MODÈLE À UN 208V TO 240V TRIPHASE UTILITAIRE TENSION QUE L'APPAREIL NE FONCTIONNE PAS.

5.4 AC Input Connections



WARNING

The AC input connections must include a disconnect device (an external switch or circuit-breaker) as part of the installation. The disconnect device must be suitably located and easily reached and must be marked as the disconnecting device for the equipment. The disconnect device must disconnect all line conductors simultaneously.

An external overcurrent protection device must be provided (by, e.g., fuses or circuit breaker). The breaking capacity of the overcurrent protection device should be compatible with the current rating of the installation.

A minimum of basic insulation is required between mains-connected parts of opposite polarity on the supply side of the overcurrent protection device.

Overcurrent protection devices shall not be fitted in the protective conductor. Fuses or single pole circuit-breakers shall not be fitted in the neutral conductor of multi-phase equipment.

Installation should be in accordance with ANSI/NFPA 70, NEC.

After disconnecting grid power, ALWAYS wait at least 1 minute, then use a Digital Voltmeter (DMM) in VDC Mode to check for any residual DC voltage from each Line terminal to the Chassis ground stud to check for safe voltage levels (< 5 Vdc) before touching the unit or any terminal blocks or pins.



AVERTISSEMENT

Les connexions d'entrée AC doivent inclure un dispositif de déconnexion (un commutateur externe ou disjoncteur) dans le cadre de l'installation. Le dispositif de déconnexion doit être convenablement situé et facilement accessible et doit être marqué comme le dispositif de déconnexion de l'équipement. Le dispositif de déconnexion doit déconnecter tous les conducteurs de ligne simultanément.

Un dispositif de protection de surintensité externe doit être fourni (par exemple, par des fusibles ou coupe-circuit). Le pouvoir de coupure du dispositif de protection contre les surintensités doit être compatible avec le courant nominal de l'installation.

Un minimum d'isolation de base est nécessaire entre les parties de réseau connecté de polarité opposée sur le côté d'alimentation du dispositif de protection contre les surintensités.

Les dispositifs de protection contre les surintensités ne doivent pas être installés dans le conducteur de protection. Fusibles ou simples disjoncteurs ne doivent pas être installés dans le conducteur neutre des équipements multi-phasés.

L'installation doit être conforme à la norme ANSI / NFPA 70, NEC.

Après avoir débranché l'alimentation du réseau, attendez TOUJOURS au moins 1 minute, puis utilisez un voltmètre numérique (DMM) en mode VDC pour vérifier toute tension CC résiduelle de chaque borne de ligne sur le plot de masse du châssis pour vérifier les niveaux de tension sécurisés (<5 Vcc) avant de toucher l'unité ou des borniers ou des broches.

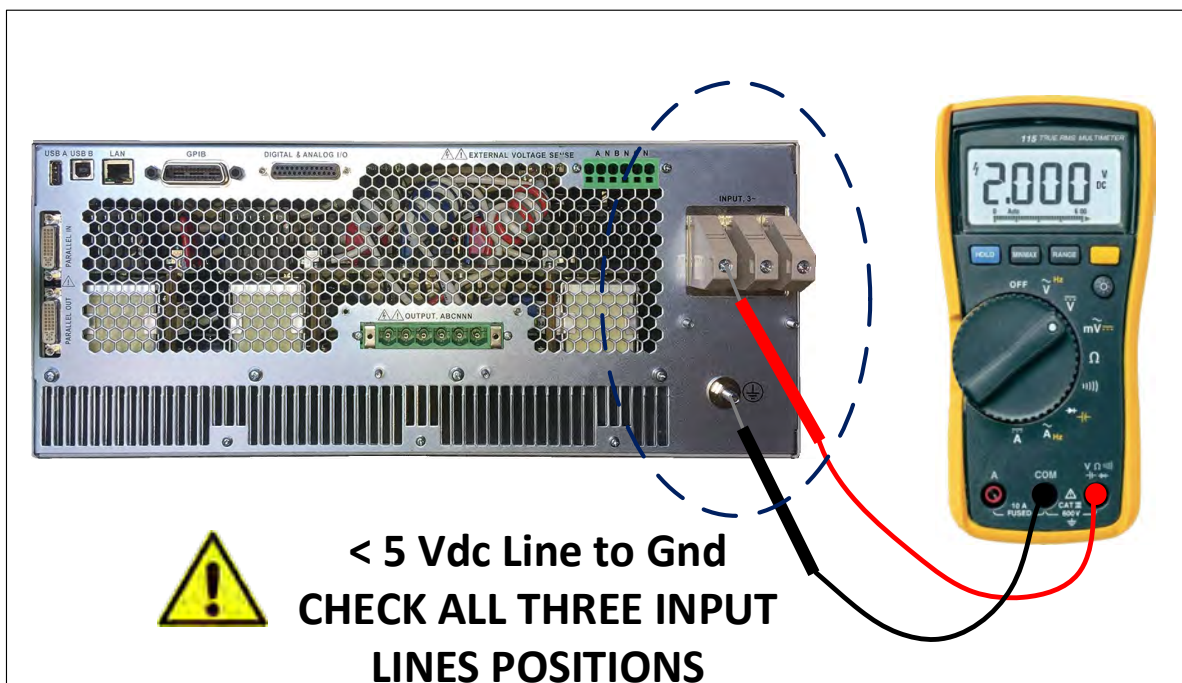

Consult the table below for recommended wire size by model number and AC input rating.

MODEL	INPUT VOLTAGE	INPUT CURRENT	RECOMMENDED INPUT SERVICE	MINIMUM COPPER WIRE SIZE, 75°C RATED
190ADF-2	208 V ac, 3~	37 A rms, max	40 A rms	10 mm ² (AWG 8)
1150ADF-2	208 V ac, 3~	55 A rms, max	60 A rms	21 mm ² (AWG 4)
3150ADF-2	208 V ac, 3~	55 A rms, max	60 A rms	21 mm ² (AWG 4)
190ADF-4	380/400 V ac, 3~ 480 V ac, 3~	20 A rms, max 16 A rms, max	25 A rms 20 A rms	6 mm ² (AWG 10) 4 mm ² (AWG 12)
1150ADF-4	380/400 V ac, 3~ 480 V ac, 3~	30 A rms, max 24 A rms, max	35 A rms 30 A rms	10 mm ² (AWG 8) 6 mm ² (AWG 10)
3150ADF-4	380/400 V ac, 3~ 480 V ac, 3~	30 A rms, max 24 A rms, max	35 A rms 30 A rms	10 mm ² (AWG 8) 6 mm ² (AWG 10)

Table 5-1: AC Input Wire Size Table

Note: Maximum wire size that will fit the AC Input terminal block is AWG 4.

AWG	Diameter		Turns of wire, without insulation		Area	
	(in)	(mm)	(per in)	(per cm)	(kcmil)	(mm ²)
4	0.2043	5.189	4.89	1.93	41.7	21.2

The AC input connections must be made at the rear panel AC terminal block. This input block has a removable safety cover that must be installed when the instrument is used on a bench or is otherwise accessible at the rear. If mounted in a cabinet with a locked door or screen, the AC input safety cover may be omitted if needed.



Figure 5-3: Rear Panel Layout

EARTH GROUND

The AC input terminal phasing is marked on the rear panel and shown in the illustration below. A four wire mains connection is required. (L1, L2, L3 and Earth Ground). Ground connection is located directly below the AC Line input terminal block as shown in Figure 5-3 above.

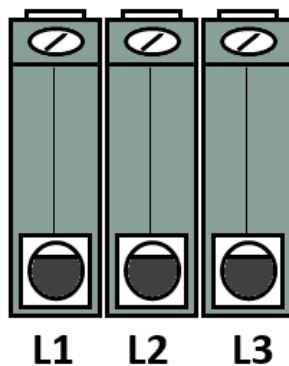

Figure 5-4: AC Input Terminal Block - Rear Panel

5.5 Grounding Requirements

5.5.1 Chassis Ground Connection Required



WARNING

SHOCK HAZARD: Equipment must be grounded.



AVERTISSEMENT

RISQUE DE CHOC: l'équipement doit être mis à la terre.

The unit **MUST** be grounded via the AC Input. A line cord with proper Earth Ground must be used at all times. Correct grounding of your electrical system infrastructure according to applicable national standards must also be observed.

5.5.2 Output Neutral Grounding

The output neutral terminals of the power source are **NOT** connected to earth ground but rather floating. This allows the output of the power source to float with respect to ground. Some loads will have their neutral input grounded, which will result in the power source neutral being grounded through the load. Alternatively, the user may ground the output neutral terminals himself by running a suitable wire size from one of the output neutral terminals to the ground stud on the rear panel of the power source as shown in Figure 5-5.

Grounding the output neutral can help reduce common mode noise at the output of the power source.

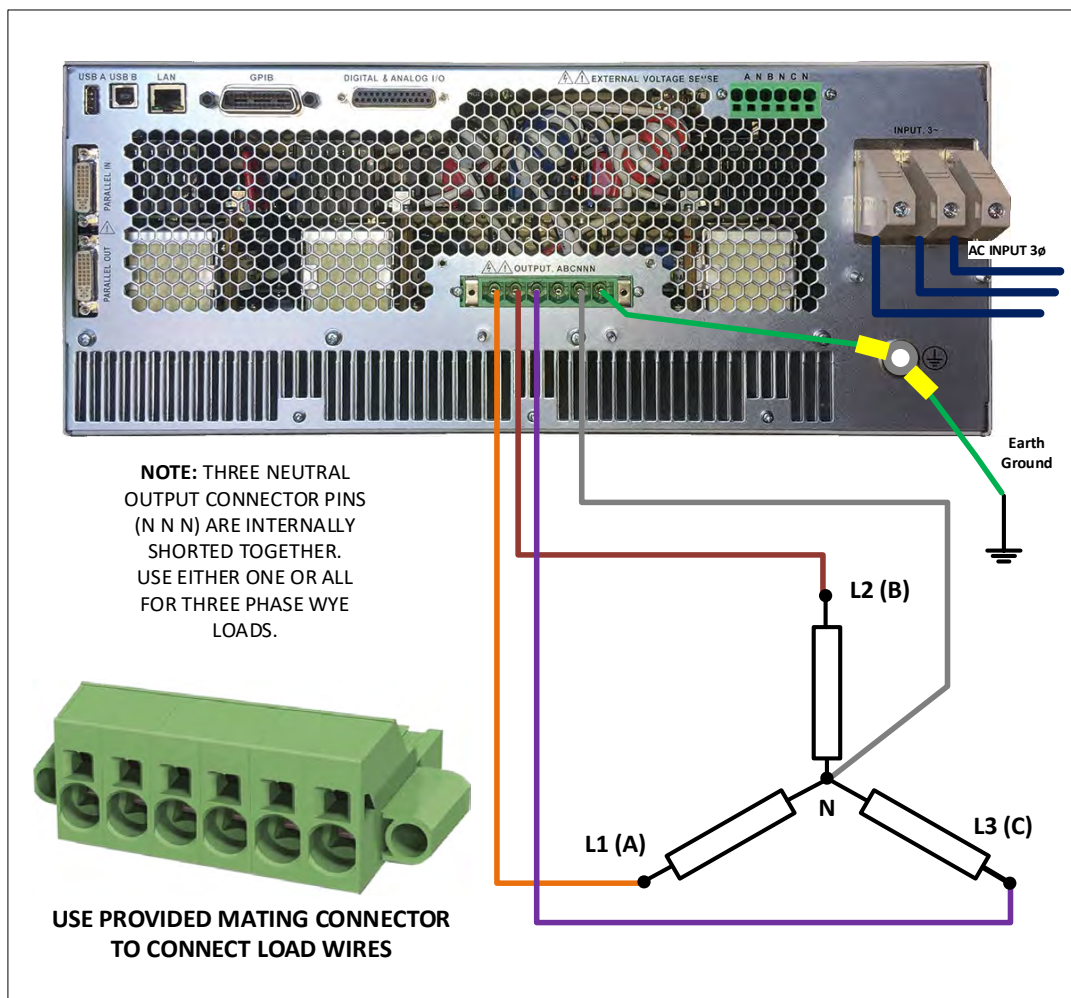

Figure 5-5: Grounding Floating Neutral Output

5.6 AC Input Circuit Breaker

This product is fitted with a mains input circuit breaker on the left hand side of the front panel. The power off position of the circuit breaker handle is marked “O”. The power on position of the circuit breaker is marked “I”.

5.7 Bench Use



CAUTION

When placing this instrument on a workbench or table, ensure the maximum weight rating of the bench/table exceeds the actual weight of the unit.



ATTENTION

Lorsque l'appareil est placé sur un banc de travail ou une table, s'assurer que la capacité de charge maximale du banc / table dépasse le poids réel de l'appareil.

The ADF Series® chassis is not equipped with surface protection feet as it is intended primarily for 19" rack mount use. When used on a bench, use care not to damage bench surface by sliding ADF unit.

5.8 Rack Mounting

The ADF Series® chassis is designed to be rack mounted in a standard 19-inch rack for system applications. Zero stacking with other units or test equipment is possible. The weight of the unit **MUST** be supported properly. Either use rack slides or L brackets of sufficient weight rating that are compatible with the dimensions of the cabinet used.

ADF Series® models with an output power rating above 15KVA are available as factory installed 19" instrument cabinet systems including input and output wiring to connection terminal blocks at the bottom rear of the cabinet.

Customers (i.e. System Integrators) preferring to install one or more ADF units in their own cabinet systems can order Master and multiple Auxiliary parallel systems as a **KIT** with no 19" cabinet or wiring included.

5.9 Airflow

The ADF Series® of AC power sources are cooled by drawing in air through the front and out at the back of each unit. Do not ADF units install in a manner that blocks the free flow of air such as in a cabinet with a solid rear door. Allow a minimum of 6" (15 cm) free of obstructions behind the unit to prevent overheating.

5.10 Sound Levels



WARNING

Sound pressure level from power source may exceed 85 dBA.

Sound pressure level should be measured both at the operator's position in normal use and at whatever point 1 meter from the power source enclosure that has the highest sound pressure level.

The installer shall provide measures to reduce the sound pressure level at the operator's point of use to a safe level. These measures may include the fitting of noise-reducing baffles or hoods or provision of protective earpieces.



AVERTISSEMENT

Le niveau sonore de l'appareil peut dépasser 85 dBA.

Le niveau sonore doit être mesuré à la fois à la position de l'opérateur en utilisation normale et quelque soit le point à 1 mètre de l'enceinte de l'appareil qui a le niveau sonore le plus élevé.

L'installateur doit prendre des mesures visant à réduire le niveau sonore au point d'utilisation de l'opérateur. Ces mesures peuvent inclure la mise en place de hottes antibruit, ou la fourniture d'oreillettes de protection.



When the equipment is operated at or near full rated output power, fan speed will be at its highest and corresponding noise levels will be higher. Operators should wear ear protection while exposed to these levels of sound.

5.11 Cleaning



CAUTION

BEFORE you clean the unit, switch the unit off at the front panel breaker AND remove all mains power using the mains disconnect.

- Please do NOT use any organic solvent capable of changing the nature of the plastic such as benzene or acetone.
- Please ensure that no liquid is allowed to penetrate this product.



ATTENTION

AVANT de nettoyer l'appareil, mettez l'appareil hors tension au niveau du disjoncteur de face avant ET retirez tout câble d'alimentation secteur.

- Ne pas utiliser **de** solvant organique capable de changer la nature de la matière plastique tel que le benzène ou l'acétone.
- Veiller à ce qu'aucun liquide ne pénètre à l'intérieur de l'appareil

To clean this product, use a soft or slightly damp cloth.

5.12 Air Intake Filter Removal and Cleaning

Units equipped with a removable air intake filter must have their filter material cleaned on a regular basis. A six-month cleaning interval is recommended. For units deployed in particularly dirty environments, this cleaning interval should be shortened to three months or less to prevent the air filter from clogging up with dirt. This applies to both Master units and Auxiliary units.



Figure 5-6: Air Intake Filter Removal

5.12.1 Air Filter Removal

To remove the air filter, proceed as follows:

1. Turn the unit off first. Using a small Philips screwdriver
2. Remove the four M3 Philips screws from each corner of the filter panel on the front of the unit.
3. Pull the filter panel toward you carefully and remove the filter material.

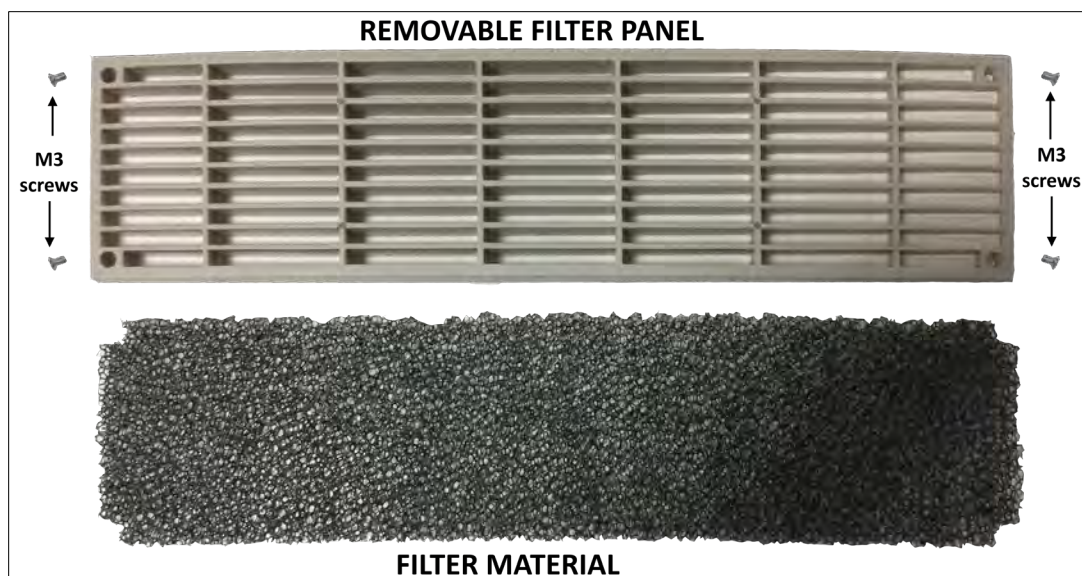

Figure 5-7: Air Intake Filter and Filter Panel

5.12.2 Filter Cleaning

Use warm water and some mild detergent to rinse all dirt out of the filter material. Allow the filter to dry for 2 hours or more till fully dry before re-installing. If the filter material is too dirty to clean, replace with a new filter. Contact customer service for replacement filters.

5.12.3 Air Filter Installation

To reinstall the filter material, proceed as follows:

1. Place the cleaned filter material against the lower part of the units front panel.
2. Line up the filter materials so the corner cut-outs align with the four corners
3. Install the removable filter panel using the four M3 Philips screws.

5.13 Liquids

The ADF Series® of AC power sources are not protected against liquid spills. Do not install where chemicals are used or where liquids could be spilled into the unit.

5.14 Load Connections



WARNING

HAZARDOUS OUTPUT: The power source output may be set to hazardous voltage levels. It provides basic isolation from the AC input mains. Therefore, the output must always be considered hazardous. Connections must be inaccessible to the operator in all situations when AC input mains voltage is applied.

Always disconnect power supply from the mains before connecting or disconnecting to the hazardous output terminals.



AVERTISSEMENT

SORTIE DANGEREUSE: La sortie de l'appareil peut être réglée à des niveaux de tension dangereux. L'appareil fournit une isolation de base du réseau d'entrée AC. Par conséquent, la sortie doit toujours être considérée comme dangereuse. Les connexions doivent être inaccessibles à l'opérateur dans toutes les situations où la tension d'entrée secteur est appliquée.

Toujours débrancher l'alimentation secteur avant de connecter ou déconnecter les bornes de sortie dangereuses.

The AC power source can be configured for either single-phase output or three-phase output.

Note: The External Voltage Sense connector always has three phase and three neutral connections but in single-phase mode of operation, only the A phase and one neutral connection are required.

5.14.1 Output Wiring and Recommended Wire Sizing

Connections from the AC source output terminal to the load should be made using the provided mating output connector. This connector is safety rated and does not require an output cover. It **MUST** be used when connecting load wires.

Load current is a function of the load so care must be taken by the end user to select appropriately sized output wires in accordance with local electrical codes.

Maximum output voltage and current ratings of the available power source models are shown in section 4, "Technical Specifications" and should be consulted when determining correct wire size. Also consider the voltage insulation rating of the load wires and External voltage sense wires used.

5.14.2 Three Phase Wye or Split Phase Load Output Connection – 3150ADF

Connection of a three-phase load requires the mating connector provided in the 3150ADF ship kit. This six-pole connector uses a spring loaded wire attachment system. To unlock a position, use a small screwdriver or pin to push down in the square hole located directly above each connection. Once you push in, you will feel to spring unlatch. Now push the stripped wire end into the connector and pull out the small screwdriver or pin. This will release the spring locking down the wire. Use a pull test to make sure the wire is clamped down securely.



Note: The output terminal diameter is 16 mm² so largest wire gauge that can be used is AWG6.

AWG	Diameter		Turns of wire, without insulation		Area	
	(in)	(mm)	(per in)	(per cm)	(kcmil)	(mm ²)
6	0.1620	4.115	6.17	2.43	26.3	13.3

Repeat for the three (3 Phase load) or two phase (Split phase load) wires and the neutral wire. Note that the three neutral positions on the rear panel output power connector are all shorted together inside the ADF. Thus, there is only one neutral, which is common for all output phases. For balanced three phase Wye loads, only one of these three neutral output positions has to be connected to the load’s neutral position.

For split phase load applications, the A and B phases are connected to the load. The C phase load and C phase Voltage sense connections are not used.

The requisite WYE load output wiring is shown in Figure 5-8 using internal voltage sense and Figure 5-9 when using external voltage sense.

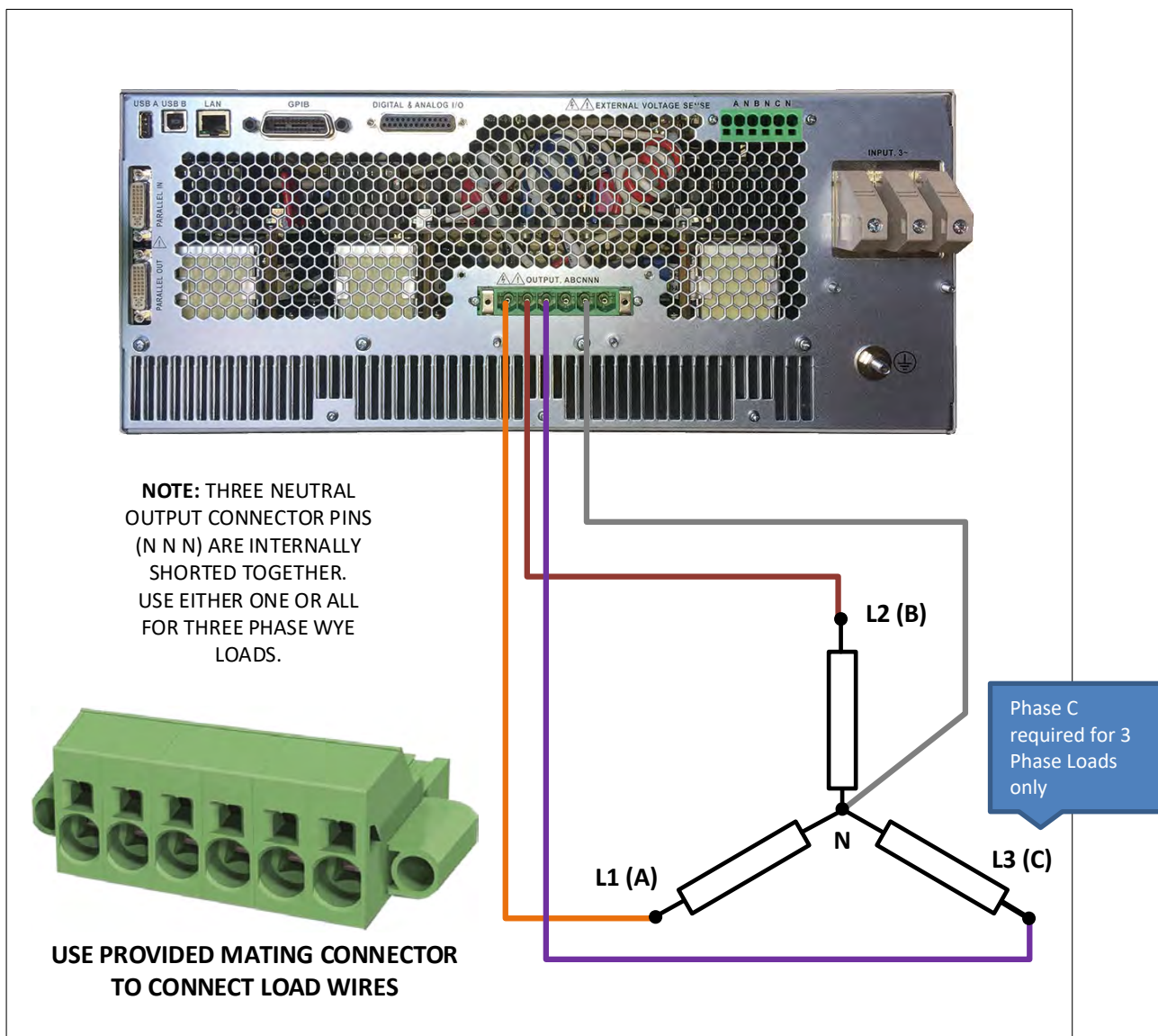

Figure 5-8: Three phase Wye or Split phase Load Output Connections – Internal Voltage Sense

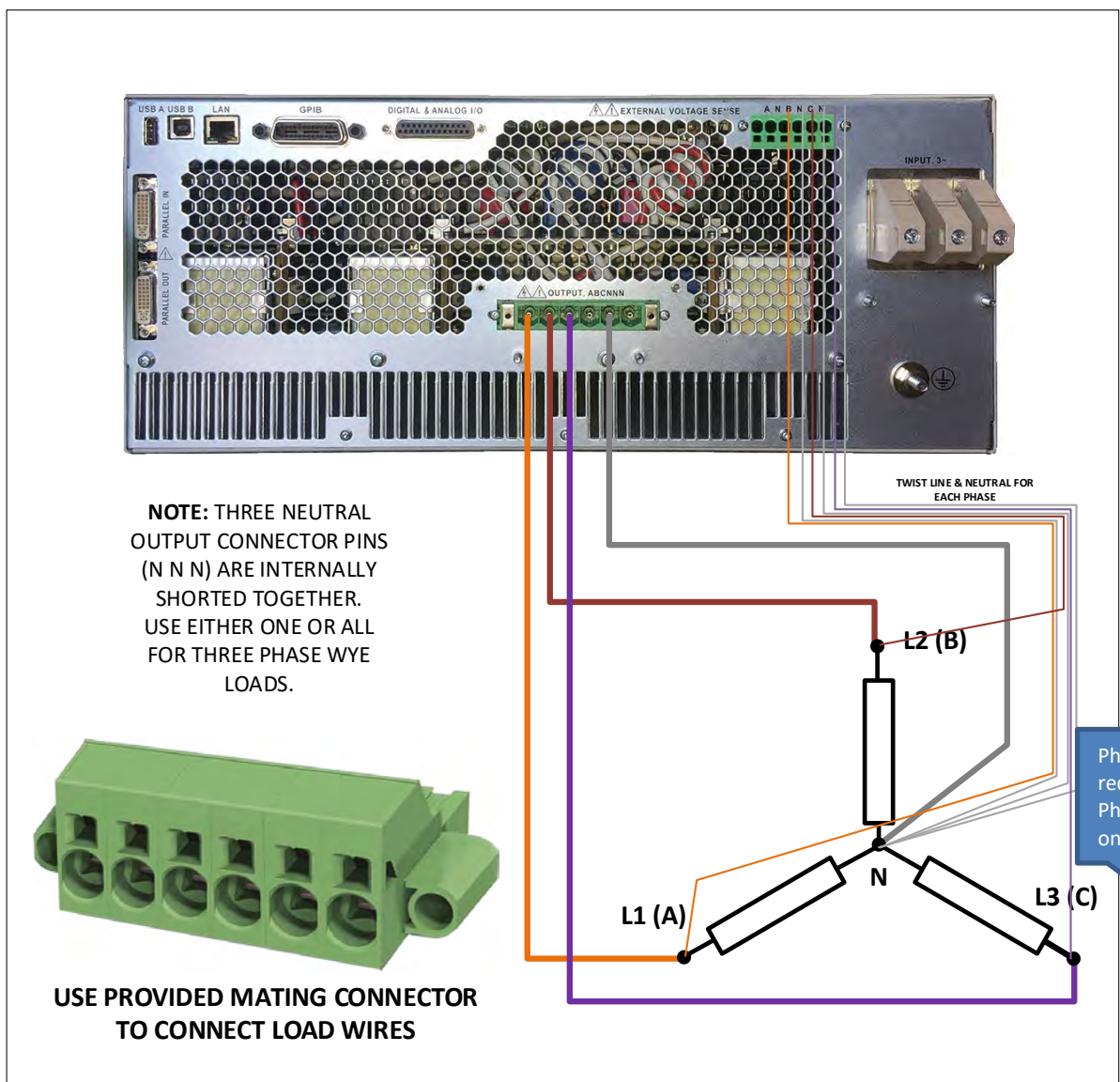

Figure 5-9: Three phase Wye or Split phase Load Output Connections – External Voltage Sense

5.14.3 Three Phase Delta Load Output Connection – 3150ADF Only

Connection of a three-phase load requires the mating connector provided in the ADF Series® ship kit. This six-pole connector uses a spring loaded wire attachment system. To unlock a position, use a small screwdriver or pin to push down in the square hole located directly above each connection. Once you push in, you will feel to spring unlatch. Now push the stripped wire end into the connector and pull out the small screwdriver or pin. This will release the spring locking down the wire. Use a pull test to make sure the wire is clamped down securely.



Repeat for the three phase wires. For Delta loads, there is no neutral connection.

Note: The output terminal diameter is 16 mm² so largest wire gauge that can be used is AWG6.

AWG	Diameter		Turns of wire, without insulation		Area	
	(in)	(mm)	(per in)	(per cm)	(kcmil)	(mm ²)
6	0.1620	4.115	6.17	2.43	26.3	13.3

Repeat for the three phase wires. For Delta loads, there is no neutral connection.

The requisite DELTA load output wiring is shown in Figure 5-10 using internal voltage sense and Figure 5-11 when using external voltage sense.

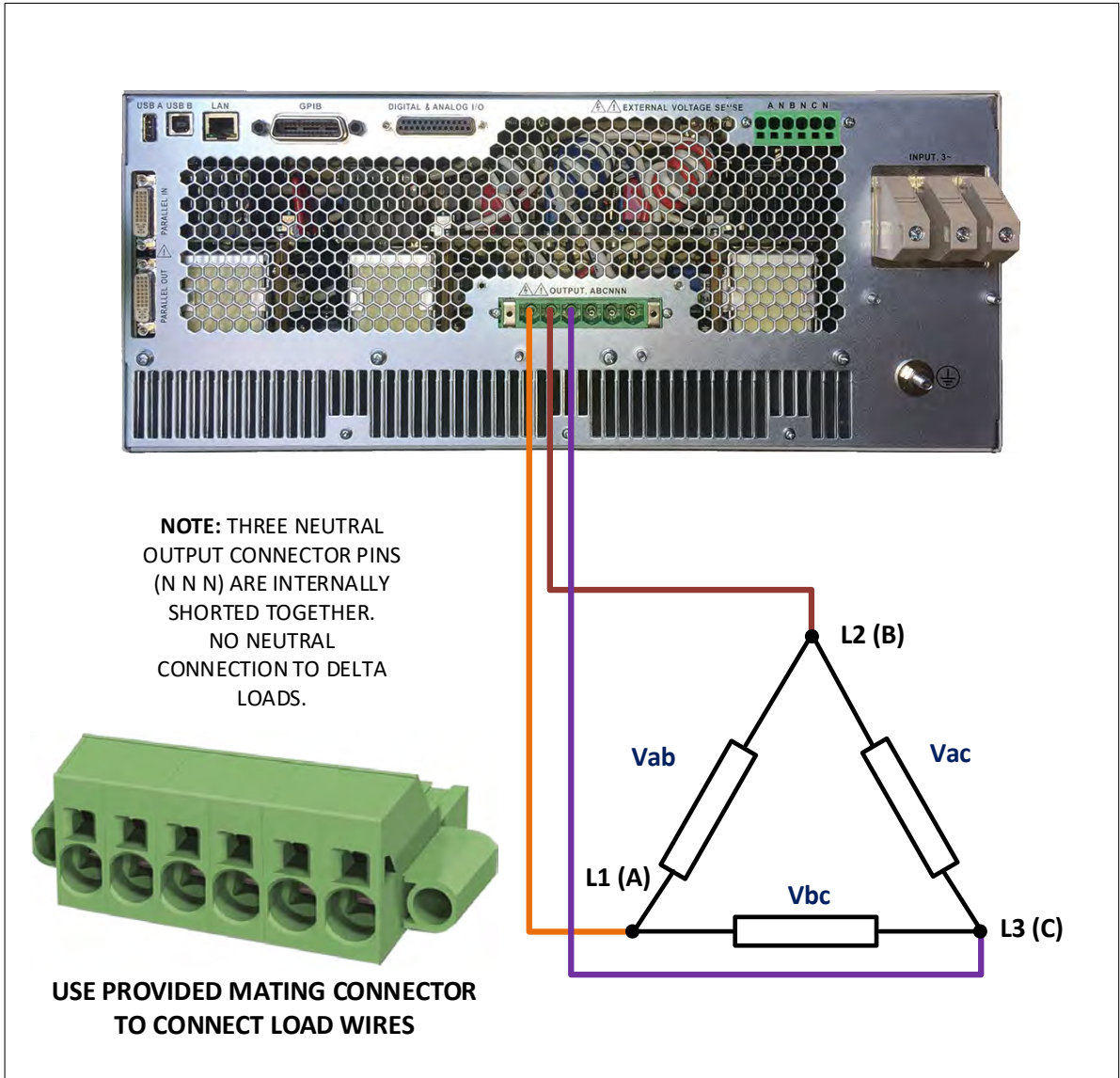

Figure 5-10: Three phase Delta Load Output Connections – Internal Voltage Sense

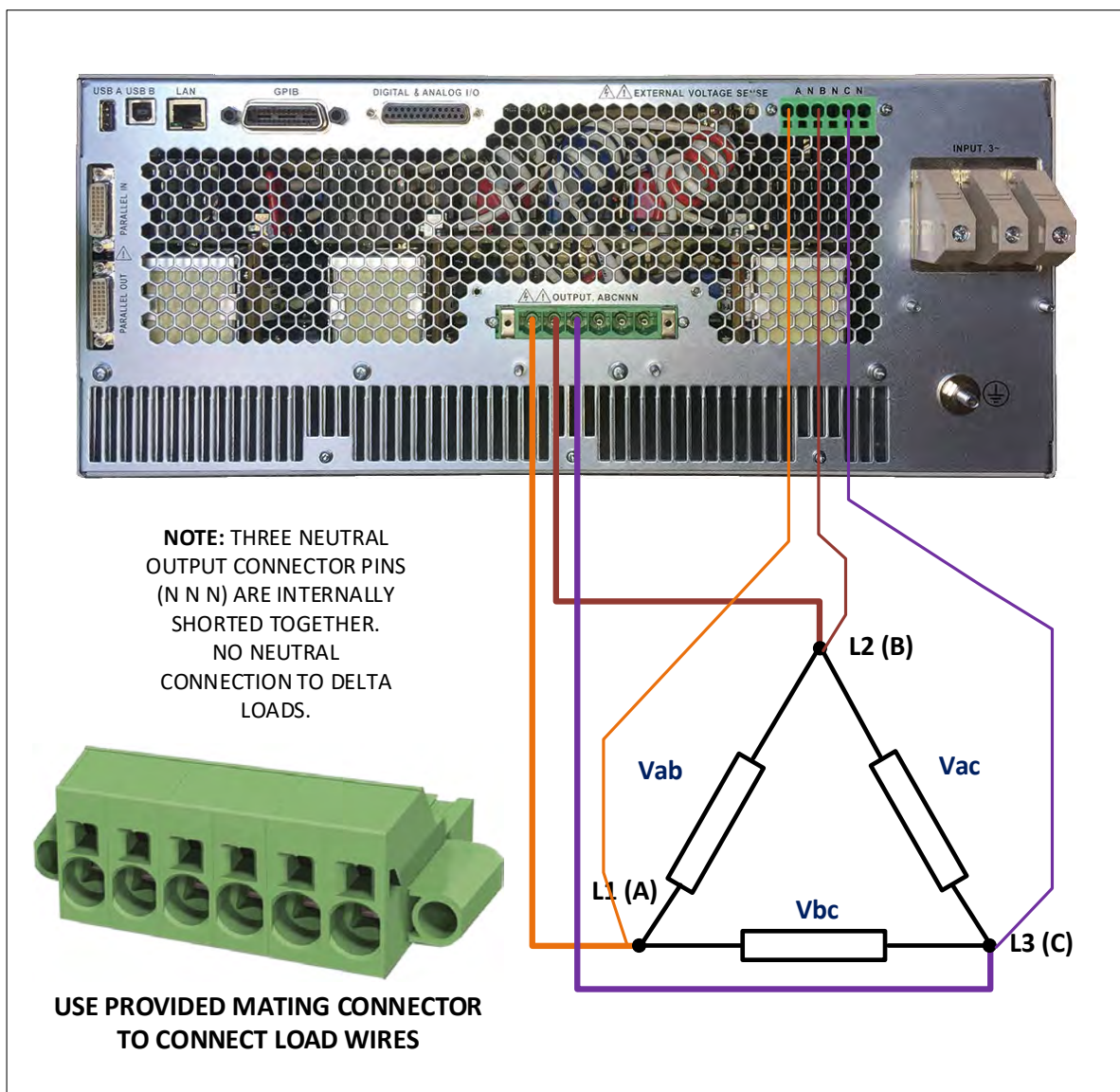

Figure 5-11: Three phase Delta Load Output Connections – External Voltage Sense

5.14.4 Single Phase Load Output Connection – 1150ADF Only

Connection of a single phase load can be accomplished by using the single phase shorting connector . (Part number 160086) provided in the 1150ADF ship kit. This requires shorting of the three phase outputs.



Figure 5-12: 1150 ADF Single Phase Shorting Adaptor assembly

Connect phase A output to the Line connection of the AC load. Connect the neutral output to the Neutral connection of the AC load. Refer to Figure 5-13 for single-phase load connection diagram.

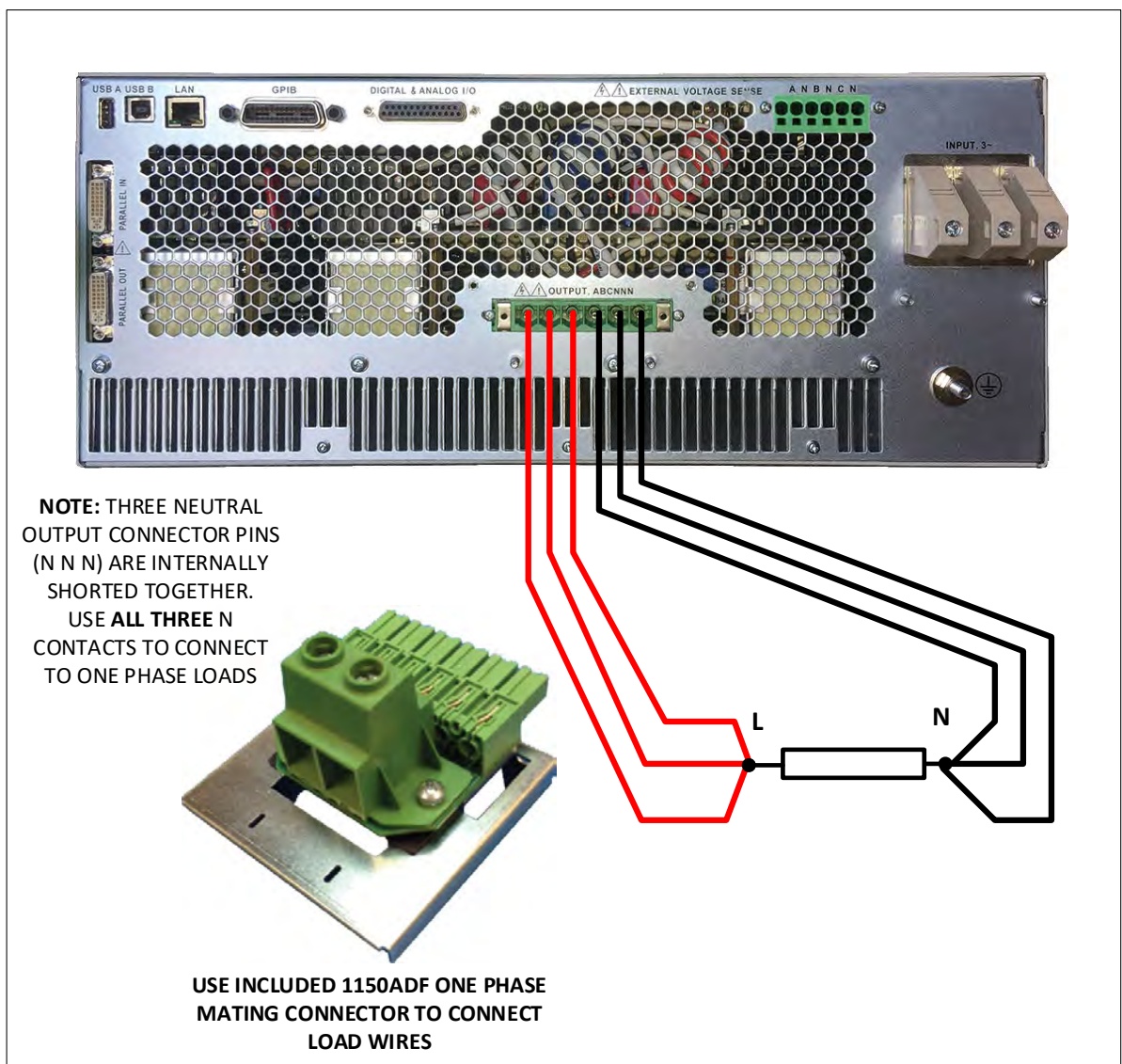

Figure 5-13: Single phase Load Output Connections

5.14.5 External Voltage Sense Connections

**WARNING**

HAZARDOUS OUTPUT: The power source output may be set to hazardous voltage levels. It provides basic isolation from the ac input mains. Therefore, the external voltage sense must also always be considered hazardous. Connections must be inaccessible to operator in all situations when ac input mains voltage is applied.

Always disconnect power supply from the mains before connecting or disconnecting to the hazardous external voltage sense terminals.

**AVERTISSEMENT**

SORTIE DANGEREUSE: La sortie de l'appareil peut être réglée à des niveaux de tension dangereux. L'appareil fournit une isolation de base du réseau d'entrée AC. Par conséquent, les connexions de sense externes doivent toujours être considérées comme dangereuses. Les connexions doivent être inaccessibles à l'opérateur dans toutes les situations où la tension d'entrée secteur est appliquée.

Toujours débrancher l'alimentation secteur avant de connecter ou déconnecter les bornes de connexions de sense externes.

When using external voltage sense, sense wires must be connected between the rear panel External voltage sense terminal and the load. These wires do not carry any load current so can be sized accordingly.

Note: ADF-2 and ADF-4 Model units use a Push-in spring connection type external voltage sense terminal that requires no mating connector. Use a small screwdriver³ to push in the locking mechanism, push in the stripped sense wire ends and pull out the screwdriver to lock the wire in place. See for reference.

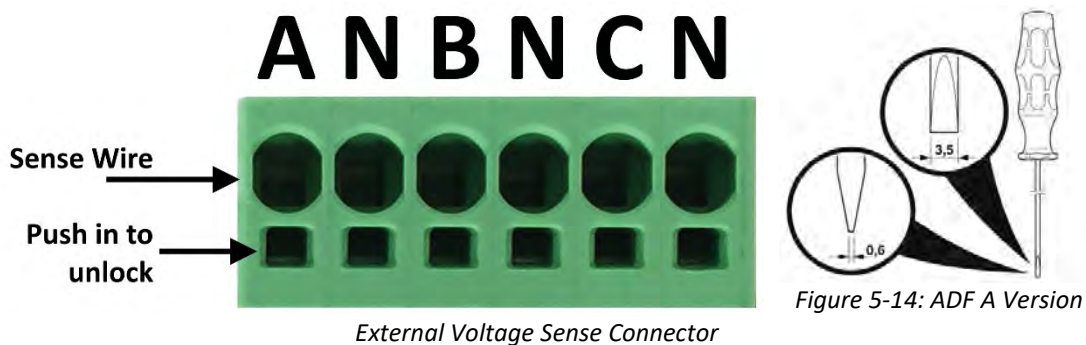

Figure 5-14: ADF A Version

Note: For three-phase sense connection wiring (model 3150ADF), refer to Figure 5-9 for 3 phase WYE load connections and Figure 5-11 for three phase DELTA load connections.

Note: For single-phase sense connection wiring (model 1150ADF), only A and Neutral sense positions have to be connected.

³ Actuation tool, bladed screwdriver, size: 0.6 x 3.5 x 100 mm

5.14.6 Powering Up

The following procedure should be followed before applying mains power:

1. Check that the front panel circuit breaker is in the OFF (O) position.
2. Verify that the model nameplate AC input specification match the local utility power.
3. Make sure that nothing is connected to any of the OUTPUT terminals on the rear panel.
4. Connect the correct AC mains line to the ADF Series® AC input terminal using a suitable three phase AC mains disconnect switch.
5. Close the AC mains disconnect to apply utility power.
6. Turn on the front panel circuit breaker by pulling the lever upward to the “I” position.

Note: Allow about 3 to 5 seconds for the ADF unit to fully initialize.

7. If the instrument does not turn on for some reason, turn OFF the front panel circuit breaker and verify the presence of the correct AC line input voltage using appropriate safety measures.

Note: For information on turning on ADF cabinet systems, refer to Section 5.16, “ADF Cabinet Systems Turn ON and turn OFF Procedures” instead.

5.14.7 In Case of Malfunction

In the unlikely event of an instrument malfunction or if the instrument does not turn on despite the presence of the correct AC line voltage, please attach a warning tag to the instrument to identify the owner and indicate that service or repair is required. Contact Pacific Power Source or its authorized representative to arrange for service.

5.15 Cabinet Systems Installation

ADF Series® power sources above 15kVA output are available pre-installed and pre-wired in a 19-inch cabinet. These cabinet systems include all internal AC input and AC output wiring. Several options can be added to these ADF cabinet systems as well.

5.15.1 Standard Cabinet Sizes

All standard ADF cabinet systems feature the same depth and width but height may vary by power level to accommodate more or less ADF units.

The following two sizes are offered:

- 18U For power levels of 30kVA or 45kVA
- 28U For power levels of 60kVA to 90kVA
- 36U For power levels higher than 90kVA

Note that alternative cabinet sizes and power levels may be supported for special requirements so this information applies to catalog models only.

Refer to cabinet dimension drawings shown below for the two available cabinet dimensions.

5.15.2 Tools Required

Installing AC Input and AC Output cable connections to the terminal blocks furnished with ADF cabinet systems requires the use of a Phillips screwdriver to remove the rear panel screen and some Allen (Hex) wrenches for the terminal blocks.



#2 x 6 Phillips Screw driver. Not included in ADF Cabinet ship kit.

5.15.3 Dimensions

Cab Size	Height incl. Casters	Width	Depth
18U	1036 mm	600 mm	900 mm
	40.8	23.6"	35.4"
28U	1480 mm	600 mm	900 mm
	58.3"	23.6"	35.4"
36U	1836 mm	600 mm	900 mm
	73.5"	23.6"	35.4"

Figure 5-15: ADF Cabinet Dimensions

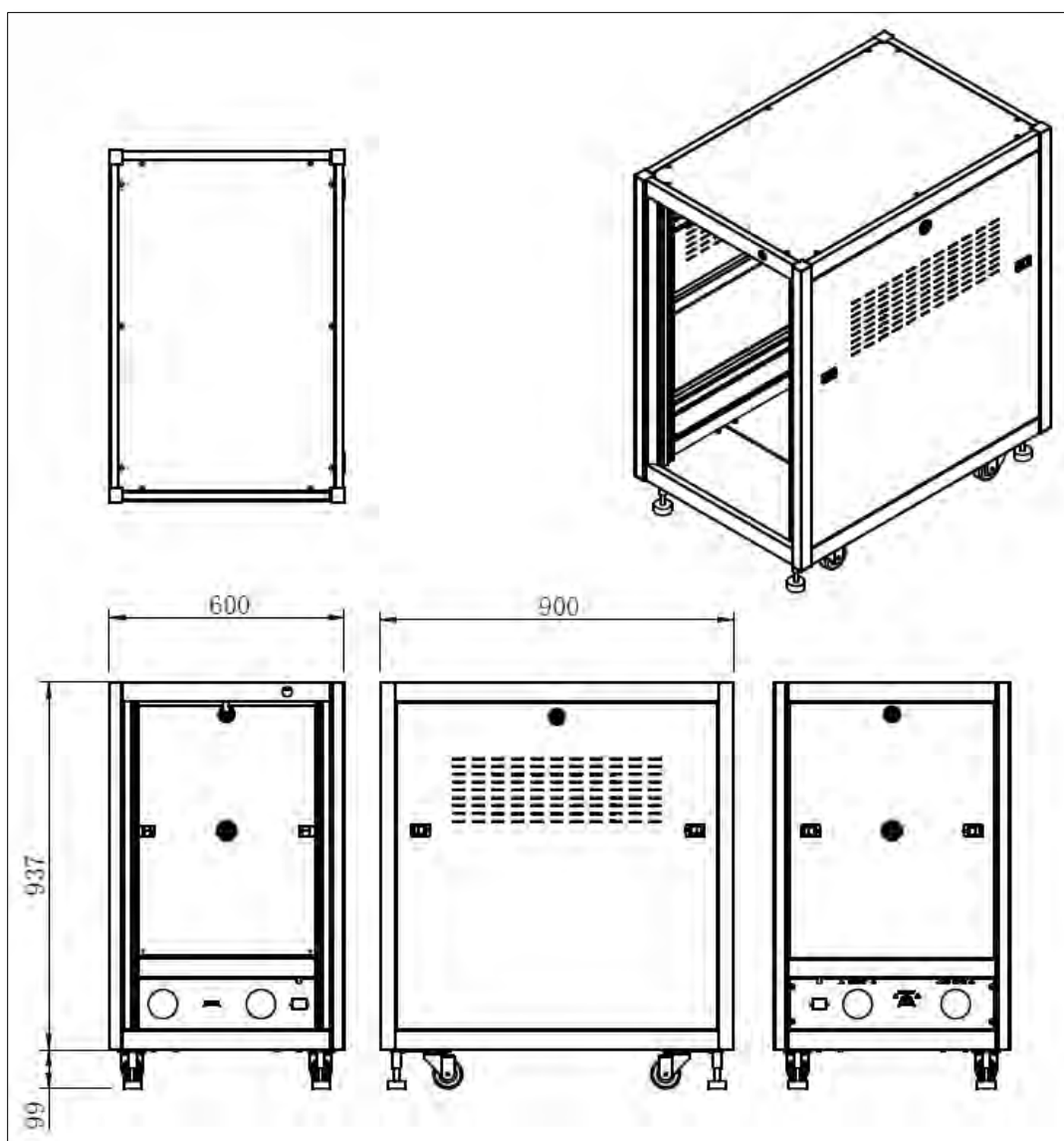

Figure 5-16: Dimension Drawing 18 U Cabinet

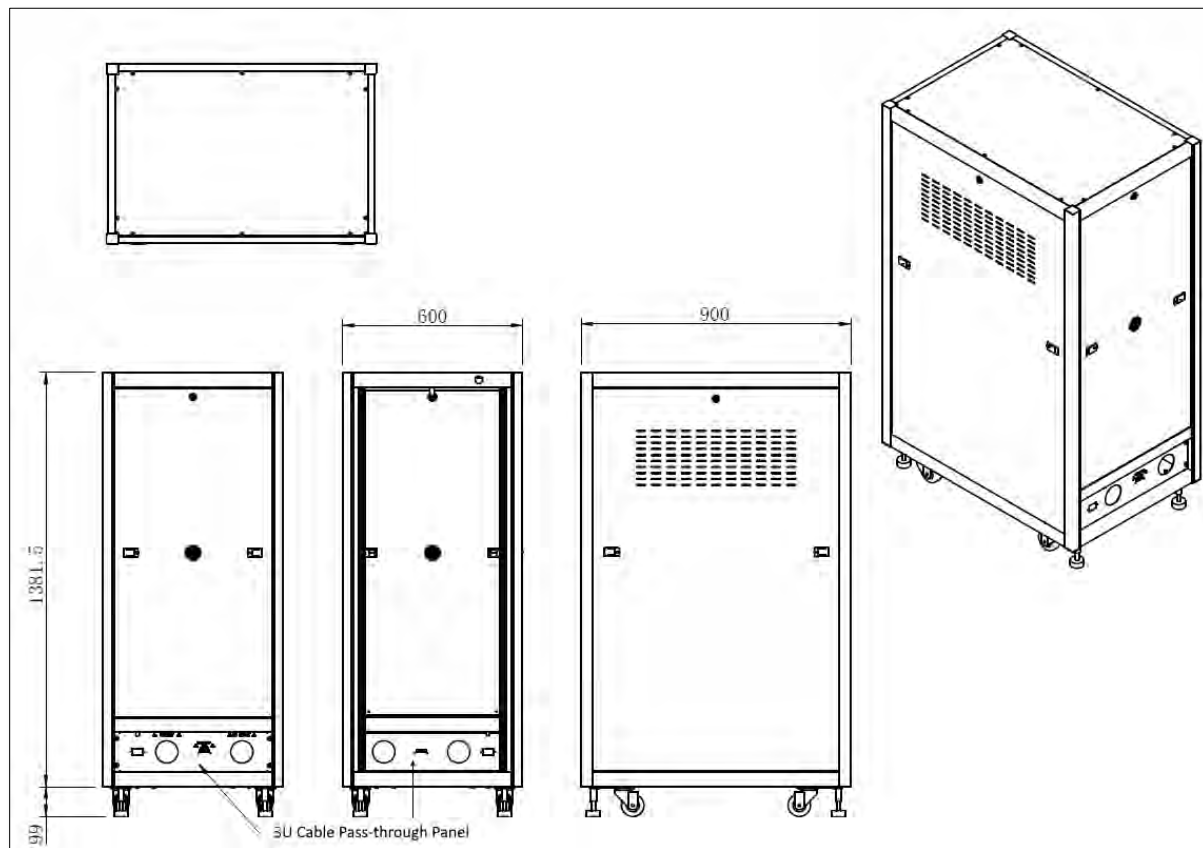

Figure 5-17: Dimension Drawing 28 U Cabinet

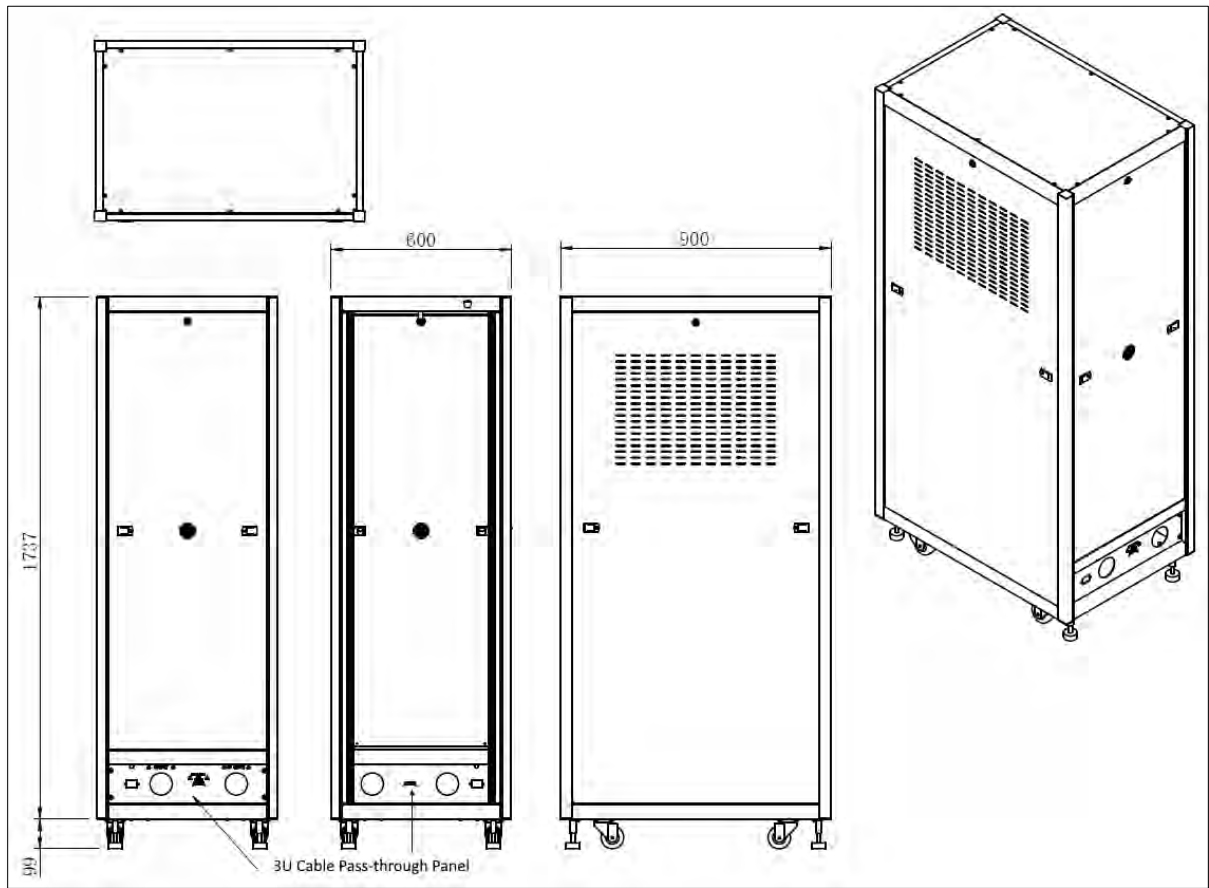

Figure 5-18: Dimension Drawing 36 U Cabinet

5.15.4 Cabinet System AC Input Connections

All input and output connections are located at the lower rear of the back of the cabinet. To access the internal terminal blocks, the rear panel grid must be removed temporarily by removing the screws that hold it to the cabinet's rear. Strain reliefs for both input and output cables are provided on the lower rear filler panel.





Note: Input and /or Output cables for grid power and load connections are NOT included with ADF cabinets.

AC input ratings for Cabinet systems are the same as for individual ADF units. The AC input rating is listed on the cabinet serial tag, which is located on the side of the cabinet. As sample ADF Cabinet System label is shown below. Maximum AC input current rating is shown per phase for the entire cabinet at low line conditions.

Note: The grid panel **MUST** be re-installed after all input and output wiring is installed.

INPUT VOLTAGE RATING ON SYSTEM LABEL

ADF SERIES CABINET SYSTEM DATA				AC INPUT VOLTAGE	
MODEL	3450ADF-4	P/N	_____	VOLTAGE	380 Vac-480 Vac, 3~
S/N	_____	CABINET	1 OF 1	AMPS MAX	90 A FREQ 47 - 63 Hz
IWA	_____	W/O	_____		
MOD	_____	CAB SIZE	28U		
ITEMS	MODEL	TYPE	S/N		
1	3150ADF-4E	MASTER	_____		
2	3150ADF-4NC	AUX	_____		
3	3150ADF-4NC	AUX	_____		
4	_____	_____	_____		

PACIFIC POWER SOURCE, INC., CA



CAUTION: GRID DISCONNECT REQUIRED

Note that a suitable grid power disconnect switch must be provided between the grid connection and the ADF Cabinet AC input terminal block. Consult an electrician to ensure proper local electrical codes are used at all times.

5.15.5 Recommended AC Input Wire Strip Lengths

The following wire strip lengths are required for the AC input wires listed.

L1, L2, L3 Wires:	11/16", 17 mm
Neutral, Ground Wires:	3/4", 19 mm

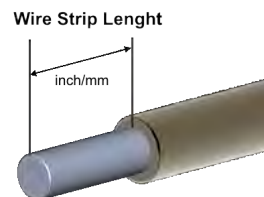

Connect AC input power three phase with correct Voltage to terminal block TB1 as shown in the figure below.

The AC i phase terminals are oriented as shown below when facing the back of the cabinet.



CAUTION: Connect the Chassis Ground Stud to earth ground to ground the cabinet. Cabinet must be grounded for safety purposes at all times.

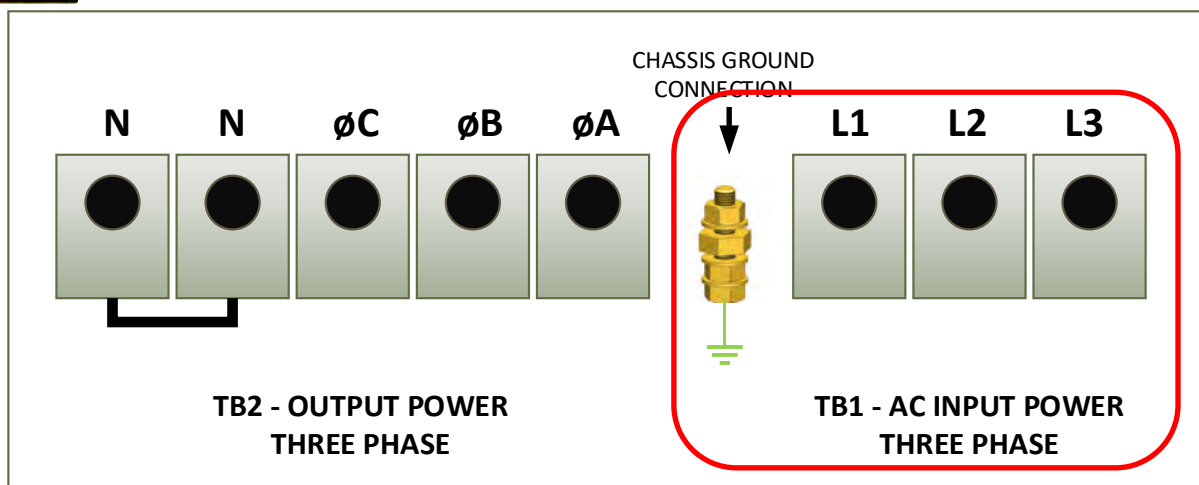

Figure 5-19: ADF Cabinet AC Input Connection Terminal Block TB1

5.15.6 Cabinet System AC Input Neutral

The ADF power sources DO NOT require a neutral connection as they operate from a Delta AC input of either 208V L-L or 380 to 480V L-L. However, some available cabinet options may operate from Line to Neutral input voltage only. If so, a neutral connection will be present at the AC input side of the cabinet and this Neutral must be brought into the cabinet (Wye). Refer to Section 5.17, "Cabinet System Options" for more details.

5.15.7 Cabinet System Grounding

All ADF cabinet systems **MUST** be properly grounded using the provided GROUND terminal on the AC Input terminal block located inside the cabinet.



SAFETY NOTICE: GROUNDING

This product is a Safety Class 1 instrument (provided with a protective earth terminal). To minimize shock hazard, the instrument chassis or cabinet must be connected to an electrical safety ground. The instrument must be connected to the AC power supply mains through a properly rated three-phase power cable with protective earth (L1-L2-L3-E). Any interruption of the protective (grounding) conductor or disconnection of the protective earth terminal will cause a potential shock hazard that could result in personal injury.

This instrument may be equipped with a line filter to reduce electromagnetic interference and must be properly grounded to minimize electric shock hazard. Operation at line voltages or frequencies in excess of those stated on the model type plate may cause leakage currents in excess of 5.0 mA peak.



REGLE DE SECURITE: MISE A LA TERRE

Ce produit est un équipement de Classe 1 (muni d'une borne de mise à la terre). Pour minimiser le risque de choc électrique, le châssis de l'appareil ou de l'armoire/rack doit impérativement être relié à une terre de sécurité électrique. L'appareil doit être branché sur le secteur d'alimentation électrique à courant alternatif par un câble d'alimentation triphasé approprié avec terre de protection (L1-L2-L3-PE). Toute interruption de la mise à la terre de protection ou de déconnexion de la borne de terre causera un risque de choc électrique qui pourrait entraîner des blessures.

Cet appareil peut être équipé d'un filtre secteur pour réduire les interférences électromagnétiques et doit être correctement mis à la terre afin de minimiser le risque de choc électrique. Le fonctionnement sous tensions et fréquences supérieures à celles indiquées sur l'étiquette peut provoquer des courants de fuite de plus de 5,0 mA peak.

5.15.8 Recommended AC Output Wire Strip Lengths

The following wire strip lengths are required for the output wires listed.

Phase A, B & C Wires: 11/16", 17 mm

Neutral Wire: 1 9/16", 40 mm

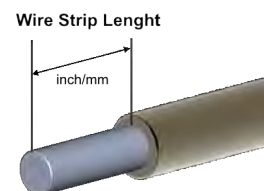

Note that there are two Neutral terminals on TB2 to support Single phase mode operation. Both Neutral terminals are shorted together.



NOTE: When operating in single phase mode, the user is responsible for shorting the A, B and C output terminal together.

5.15.9 Cabinet Load Connections

The output terminal Neutral and phase terminals are oriented as shown below when facing the back of the cabinet.

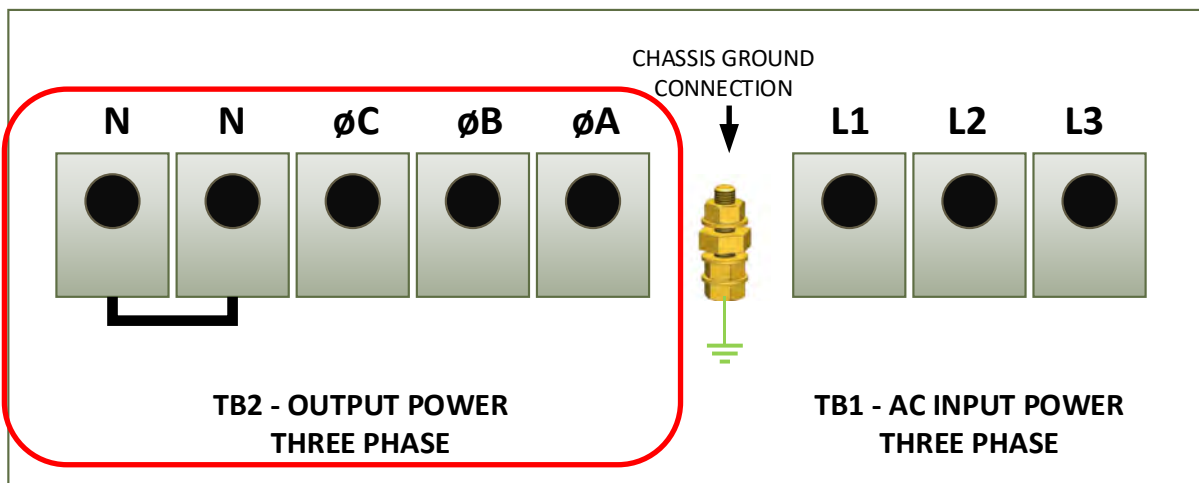

Figure 5-20: Output Power Terminal Block TB2

5.16 ADF Cabinet Systems Turn ON and turn OFF Procedures

ADF Cabinet systems can be turned on or off using the front panel mounted circuit breakers on the master and auxiliary units. Turn on and turn off sequence recommendations are listed below and illustrated in Figure 5-21. The sequence is not critical as long as units are turned on within 15 seconds of each other. If more time elapses, an error may be displayed and the master/aux discovery process should be restarted from the PARALLEL UNITS screen in the SYSTEM menu. Refer to section 6.8.7, “PARALLEL UNITS Screen”.

Alternatively, the master grid power disconnect switch that is required for cabinet installation can be used to connect or disconnect all units from grid power at the same time.

5.16.1 Cabinet Power Turn ON using Circuit Breakers

The following turn on sequence is recommended:

1. Turn **ON** bottom auxiliary unit **first** by pulling its front panel circuit lever to the upward (ON) position.
2. Turn **ON** any additional auxiliary units between the bottom auxiliary unit and the top Master unit by pulling each front panel circuit lever to the upward (ON) position.
3. Turn **ON** the Master unit **last** by pulling its front panel circuit lever to the upward (ON) position.

This will ensure all auxiliary units are up and will be found when the master starts the discovery process.

5.16.2 Cabinet Power Turn OFF using Circuit Breakers

The turn off procedures is the reverse of the turn on one as follows:

1. First, turn of ADF System output using the OUTPUT button on the Master unit front panel first to make sure any load is powered down first.
2. Then, turn **OFF** the Master unit **first** by flipping its front panel circuit lever to the down (OFF) position.
3. Turn **OFF** the first auxiliary unit located below the master unit by flipping the front panel circuit lever to the down (OFF) position.
4. Turn **OFF** the bottom auxiliary unit **last** by flipping its front panel circuit lever to the down (OFF) position.

Note: Turning off all ADF units in a cabinet DOES NOT remove MAINS power from it. If any service is to be performed on the cabinet, make sure the MAINS power (grid power) is disconnected first.

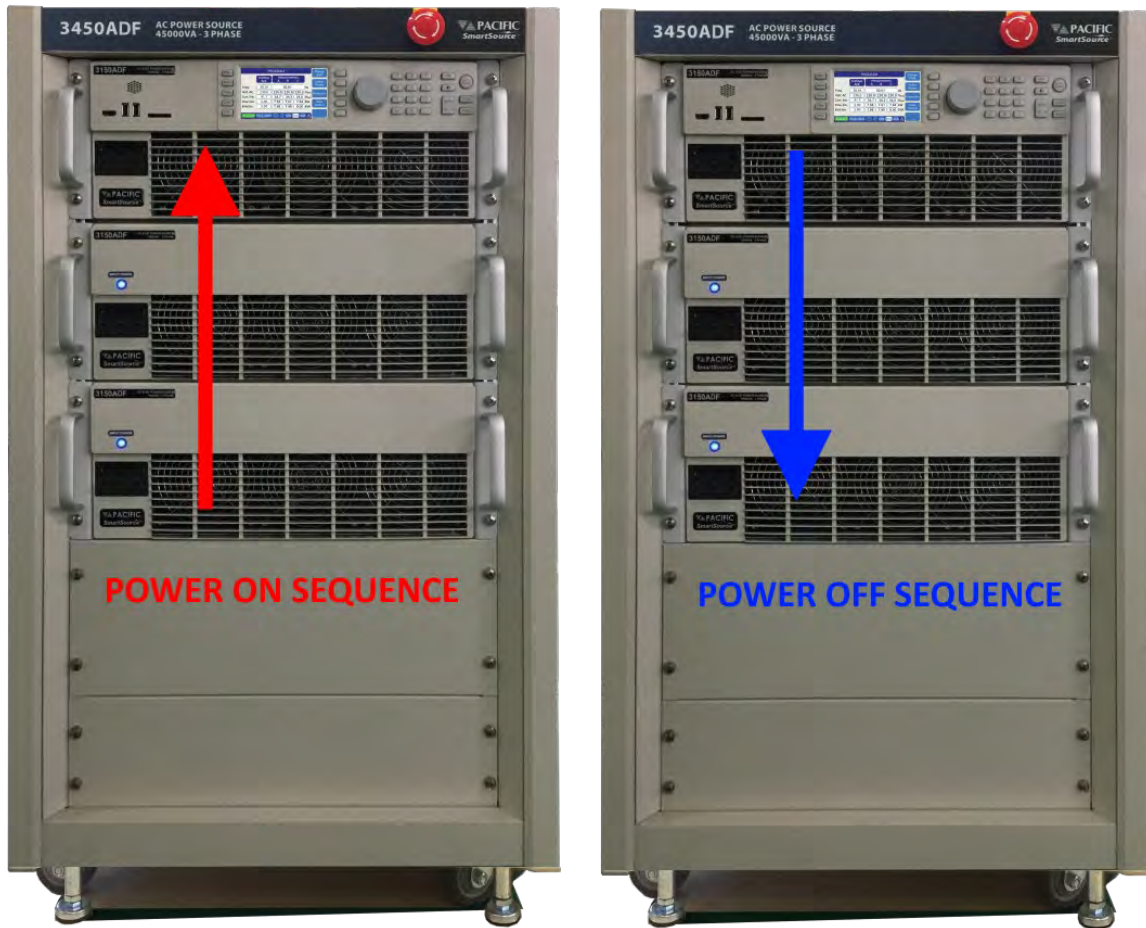

Figure 5-21: ADF Cabinet System Power ON and OFF Sequences

5.17 Cabinet System Options

The following cabinet option is available. If your cabinet was not furnished with this option, you can skip to Section 5.18, “Interface Options”.

5.17.1 -OCS: Output Control Switch Option

The output control switch option adds an output control selector switch on a 1U filler panel located directly above the master ADF unit of the cabinet. It also provides a terminal block located in the rear of the ADF cabinet that allows the user to wire in one or more series SPST switches as part of a text fixture safety interlock. Opening the front panel mounted switch will disable the output of the power source. The ON and OFF position of the OCS switch is silkscreened on the panel.



With this option installed, the Remote Inhibit function of the ADF master unit is permanently set to **REMOTE INHIBIT**. (Refer to Section 5.18.3).

5.18 Interface Options

All ADF Series® models support four different remote control interface options; USB, LAN , RS232 and GPIB. All remote control interface connectors are located at the rear panel as shown in the illustration below.



WARNING



Do NOT connect the RJ45 LAN (Ethernet) connector of the power source to a PoE (Power over Ethernet) port, as the DC voltage will damage the LAN interface.

5.18.1 Rear Panel Connector Locations

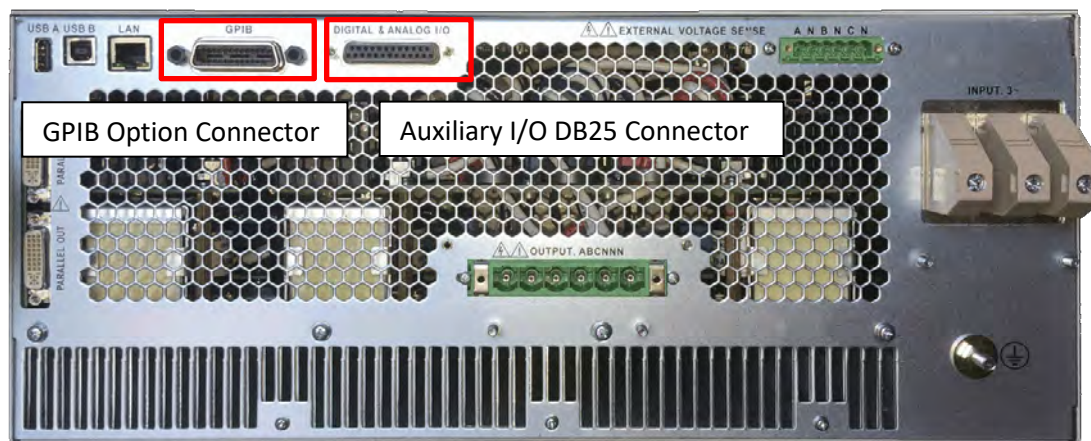

Table 5-2: Remote Control Interface Connector Locations on Rear Panel (A Versions w GPIB)

5.18.2 USB Device Interface

The USB DEVICE interface (USB Type B connector on the rear panel) provides a virtual COM port for the PC. Via this port, the unit can be controlled as a normal RS232 interface, e. g. with a terminal program or user application program. Refer to the section 9, “USB Driver Installation” for further setup and configuration information.

Refer to the section 9, “USB Driver Installation” for further setup and configuration information.

5.18.3 GPIB Device Interface

The GPIB interface uses the IEEE488.1 standard 24-pin D-Shell Amphenol micro ribbon connector. Using a standard GPIB cable, the cable will break out to the left of the unit when facing the rear. This will typically obstruct USB and LAN interface connector access. Reverse GPIB cables are available but using these will obstruct the Auxiliary I/O connector.

The GPIB pin assignments are per the IEEE488.1 standard and listed in the table below.

PIN	Signal	Description
Pin 1	DIO1	Data input/output bit.
Pin 2	DIO2	Data input/output bit.
Pin 3	DIO3	Data input/output bit.
Pin 4	DIO4	Data input/output bit.
Pin 5	EOI	End-or-identify.
Pin 6	DAV	Data valid.
Pin 7	NRFD	Not ready for data.
Pin 8	NDAC	Not data accepted.
Pin 9	IFC	Interface clear.
Pin 10	SRQ	Service request.
Pin 11	ATN	Attention.
Pin 12	SHIELD	
Pin 13	DIO5	Data input/output bit.
Pin 14	DIO6	Data input/output bit.
Pin 15	DIO7	Data input/output bit.
Pin 16	DIO8	Data input/output bit.
Pin 17	REN	Remote enable.
Pin 18	GND	(wire twisted with DAV)
Pin 19	GND	(wire twisted with NRFD)
Pin 20	GND	(wire twisted with NDAC)
Pin 21	GND	(wire twisted with IFC)
Pin 22	GND	(wire twisted with SRQ)
Pin 23	GND	(wire twisted with ATN)
Pin 24	Logic ground	

Table 5-3: GPIB Interface Connector Pin Assignments

5.18.4 LAN Interface

The LAN interface connector is installed on the rear panel. The MAC address of the unit can be found near the LAN connector.



WARNING



Do **NOT** connect the RJ45 LAN (Ethernet) connector of the power source to a PoE (Power over Ethernet) port as the DC voltage will damage the LAN interface.

No special device drivers are required to use the LAN interface as it uses TCP/IP protocol but the IP address needs to be configured to operate on the user's local area network or private network.



MAC Address

Figure 5-22: ADF Series® Rear Panel Layout

5.18.5 System Interface Bus Connectors



WARNING

SHOCK HAZARD: DO NOT remove safety covers from the two System Interface DVI Connectors.



AVERTISSEMENT

RISQUE DE CHOC: NE PAS retirer les capots de sécurité des deux connecteurs d'interface DVI

The system interface bus is not user-accessible. It consists of two Digital Visual Interface (DVI-I dual link) connectors that are covered by a protective cover. There are no user accessible signals on the system interface bus. It is used for system configuration cabinet systems only.

5.19 Multi-Unit Parallel Operation

Two or more ADF units can be configured as a parallel system to create a high power system. This requires at least one Master ADF unit and one or more Auxiliary units or Master units that will be used as Auxiliaries to the first Master.

Note: Auxiliary units or Master units used in an auxiliary position must be of the same power output as the Master unit so each unit delivers the same amount of current /power into the load.

5.19.1 Load Connections on Parallel Systems

Paralleling two or more units requires that their outputs are tied together using equal length load cables from each unit to the load. A common coupling terminal block may be used to combine outputs in combination with larger size load wires to the load. Make sure the appropriate size wiring is used for the higher current levels obtained by paralleling two or more units.

5.19.2 Parallel System Bus Connection

For both units to operate correctly, the system bus connections between the master and auxiliary units **MUST** be made. This is done by daisy chaining the master to the first auxiliary and that auxiliary to the next one.

The system interface connectors are located on the left hand side of the rear panel and marked as follows:

PARALLEL IN On the MASTER unit, this connector is **NOT CONNECTED**. This causes the unit to become a master for other parallel units at power on. On an AUX unit, this connector is connected to a MASTER unit or an AUX unit that precedes this unit in the parallel chain.,

PARALLEL OUT On the MASTER unit, this connector is connected to the first AUX unit. On the last AUX unit in the parallel chain, this connector is **NOT CONNECTED** signifying the end of the parallel chain.

The system bus uses a DVI-I Dual Link Male to Male interconnect cable with noise suppression ferrite beads. Cable length for paralleling units that are stacked in a 19" cabinet with no more than 1U space between units is 1 foot (0.3 m). Use of longer cables than 1 foot /30 cm is not recommended. If units cannot be installed in a cabinet, a longer DVI cable up to 3 feet in length may be used as an exception.

An example of the interconnect between one MASTER and one AUX is shown in the figure below.

Note: Any unused Parallel bus connector must be covered by the included safety covers.

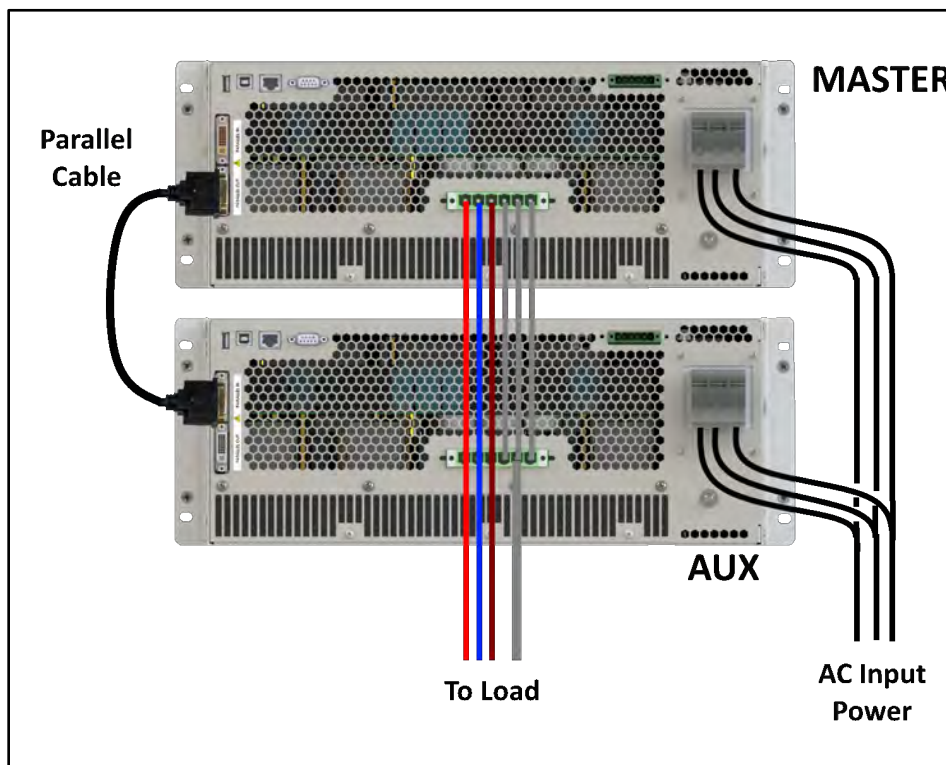

Figure 5-23: Parallel Mode Bus Connections using parallel bus cable

5.19.3 Master / Master Paralleling

Two or more masters can be paralleled as well. This allows ADF units to be used separately or as part of a larger power source system. This operation is the same and when paralleling using auxiliary units but only the first Master on the system bus will have an active front panel. All other Masters will display the fact that they are operating in Auxiliary mode with an inactive front panel. No re-configuration is of a Master unit used in an auxiliary position is required.

5.20 Multi-Cabinet Parallel Operation Guidelines

Please adhere to the following guidelines when paralleling two or more ADF Cabinet Systems. Unless these guidelines are following, optimal current sharing between cabinets cannot be guaranteed.

5.20.1 Output Wiring

1. All output wires (Neutral, Phase A, Phase B and Phase C) from each cabinet must be paralleled. Each individual output wire from each Cabinet to the output load connection **MUST BE THE SAME LENGTH AND WIRE SIZE**.
2. **DO NOT** connect any power wiring between the cabinets. The output wiring from each cabinet must be brought to a common load termination point.
3. Keep all power connections between the ADF cabinet and the load termination point as short as possible.

See diagram on next page for three phase output configuration parallel cabinets.

5.20.2 System Grounding

1. All ADF Cabinet systems **MUST** be properly grounded to the local facility ground using the provided **GROUND** terminal on the AC input terminal block located inside the cabinet.
2. In addition to individual facility ground connections, Multi-Cabinet units must be grounded to each other. This may be accomplished by connecting a ground cable to the rear of the cabinet rack on the designated Master Cabinet, passing the cable through the Input / Output power strain reliefs, and terminating the cable on the rear of the cabinet rack of the designated Auxiliary cabinet.

Refer to diagram above for suggested ground wire routing between two cabinets.

NOTE: Each cabinet should still be ground to facility ground.

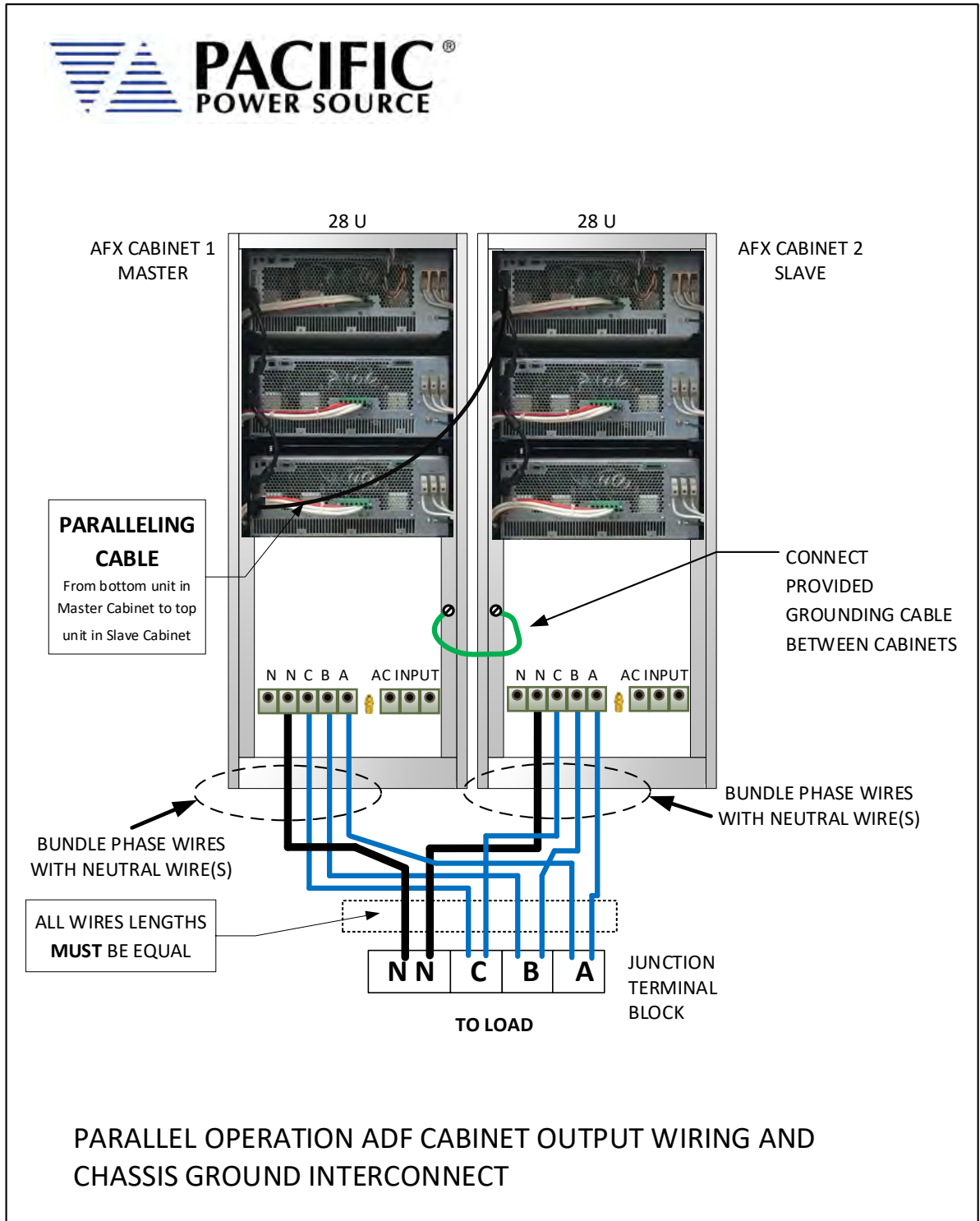

Figure 5-24: Multi-Cabinet Parallel Configuration Output Wiring - 3 Phase

6 Front Panel Operation

This Chapter provides an overview of front panel operation for the ADF Series® AC power sources. For remote control operation, refer to Section 8 “Remote Control Programming” of this manual for an overview of available programming commands.

6.1 Front Panel Layout

The front panel layout is shown in Figure 6-1 below. The number of buttons is kept to a minimum to ensure simple front panel operation for casual and experienced users alike. The shuttle knob is used to slew parameter values and move through menus to make selections.

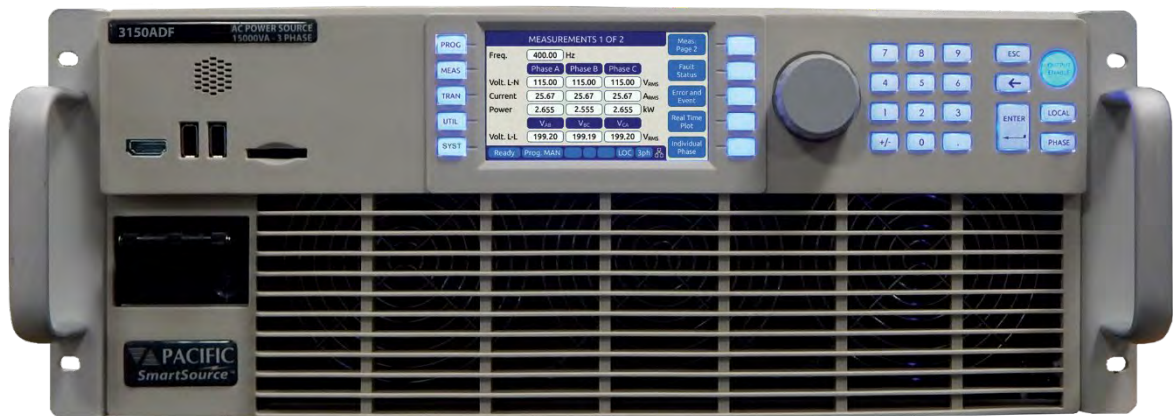
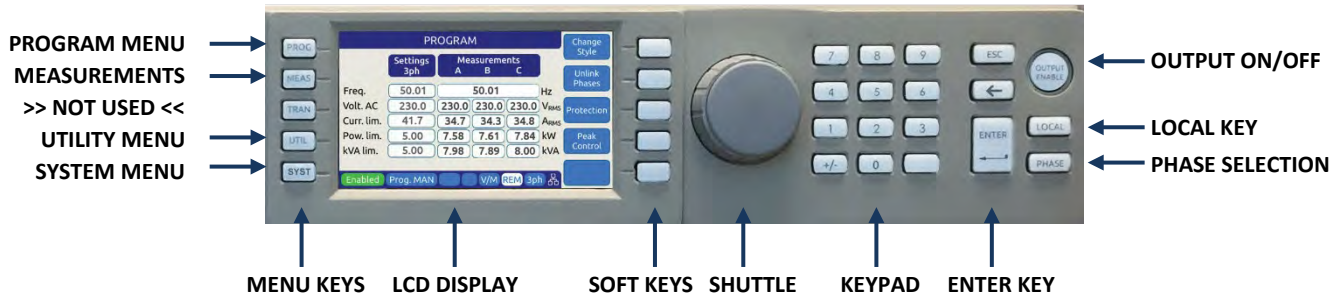

Figure 6-1: ADF Series® Front Panel View

A large backlit LCD display is located in the center. Most user controls are located directly to the right of the display. The power ON/OFF circuit breaker is located in the lower left corner of the front panel.

6.1.1 Keyboard Buttons

There are several groupings of push buttons that make up the front panel. They are grouped as follows:



Group	Function
Menu Selection Keys	These keys select the available top-level menus. Sub menus may be accessible using any of the available soft keys within each top-level menu.
Soft Keys	Soft keys change function as indicated by the decal directly to the left of the soft key on the LCD display.
Shuttle	See next section for details on shuttle operation.
Decimal Key Pad	The decimal key pad is used to enter parameter values directly. Values may also be set using any available soft key or the shuttle.
ENTER Key	The ENTER key confirms a selection or setting made with the decimal key pad. Until confirmed by pressing the ENTER key, selections and values will be shown grayed out on the LCD display to indicate they have been edited/changed but have not yet taken effect. This allows multiple parameters in the same screen to be edited with all new setting values taking effect at once when the ENTER or UPDATE ALL soft key is pressed.
ESC Key	The escape key backs out of a menu or selection and returns to a previous level.
Back Space Key (←)	This key backs up one position erasing the last digit value entered.
OUTPUT ENABLE	The OUTPUT ENABLE key is used to toggle the output on or off. If the output is ON, this key will be lit.
LOCAL	Returns the instrument to local control mode allowing front panel operation. This key may be disabled over one of the remote control interfaces. While in REMOTE, the keyboard is locked out. The LOCAL key can also be used to capture and LCD Image and store it as an .png image file in internal memory. To do so press and hold the LOCAL key, then press the 1 key. Screen images are saved in folder "internal/screenshots".
PHASE	The PHASE key is used to select a specific phase on three phase 3150ADF —models. On single phase 1150ADF models, the selected phase is always A and this key has no function.

6.1.2 Shuttle Knob

The shuttle knob or rotary digital encoder is used to navigate (scroll) through menus and select fields to modify settings. The shuttle knob also includes a SELECT push button function. Pushing in the shuttle knob (SELECT) while on a data field will allow the value to be slewed up or down.

NOTE: Unlike when using the decimal keypad to enter a value, the SELECT shuttle mode will cause the output to change immediately. This allows slewing of the actual output value.

Once the final value is reached, pressing the shuttle again will take it out of slew mode and back into scroll mode.

6.1.3 PC Monitor Output

A PC monitor output connector is located on the front panel's left side. This connector is marked with a monitor icon as shown here. This allows connection of a computer monitor. When connected, the monitor will display the information otherwise shown on the front panel LCD screen and the LCD screen itself will be off.



This feature allows for the connection of a touch enabled LCD monitor to the Video Output the front panel as well. When detected by the ADF, a message will pop-up asking the operator to change to the external screen. If accepted, the front panel LCD will turn off and the ADF screen will be display on the monitor along with a touch panel to operate the unit. The actual front panel keypad will remain active as well. This feature is useful for operator training or in control rooms where being able to read the measurement screen from across the room is required. A USB connection to one of the ADF USB ports is required to use the monitor's touch feature.

To return the display to the LCD screen, unplug the monitor.

6.1.4 USB Host Ports

Two USB host ports are located on the left hand side of the front panel. These ports will accept a USB memory device or a USB peripheral such as a mouse or keyboard. These USB ports are marked with the standard USB symbol as shown here.

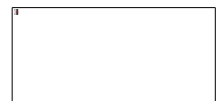

6.1.5 SD Card Memory Slot

A SD Card memory device slot is located on the left hand side of the front panel. This slot will accept a standard SD memory card. The SD Card slot is marked with the symbol shown to the right here.



6.2 OUTPUT ENABLE Button

The circular Output Enable (On/Off) button is located on the right hand side of the front panel keypad. Its unique circular shape makes it easy to find so the output can be turned off quickly if needed.

6.2.1 OUTPUT State Indication

The state of the output is indicated by the back light color of the Output On/Off button. A blue color indicates the output is OFF, a green color indicates the output is ON.

6.2.2 Energy Savings Modes

The ADF Series® was designed to conserve energy when powered on but not in actual use to power a load. This situation is common as adjustments are being made to the setup or the load before any power is applied. This mode is controlled by the state of the Output. If the output is off, the ADF will enter one of two energy savings modes:

1. **SLEEP MODE** In sleep mode, all three inverter stages are switched off. If the internal heatsink is sufficiently cool, all fans are turned off as well. This essentially means the power source draws almost no power at all yet the front panel controls, displays and all digital control interfaces remain operational so any required program changes can be made.
2. **STANDBY MODE** In standby mode, only the output inverter stage for each phase is turned off. This means the first two stages remain on while the output is off. This means the fan will run at its lowest speed setting for quieter operation. This mode is considered a fast startup mode.

The desired energy savings mode can be selected from the front panel or via one of the remote control interfaces using the OUP:FAST command (See section 8.7.1.).

6.2.3 Output On Response Times

Turning the output ON means that any power stage that was disabled for energy conservation purposes will be started and allowed to settle. This includes the output inverters. Once all power stages are up and running, the output relays are closed and whatever programmed output mode, voltage and frequency will be applied to the load. If all stages were off – power source in sleep mode – this process can take up to 2.2 seconds. If the output control mode is set to FAST mode however, only the inverters are ever turned off and output can be applied within 200 msec, which is typical for older design power source with no energy saving features or sleep mode capability.

6.3 Menu Keys

The various menus and settings available to the user from the front panel are detailed in this section of the manual.

All available menus can be accessed using the Menu keys to the left of the LCD display. The following five keys are available.

MENU KEY	MENU SCREEN	Description
PROG	PROGRAM	Programming of output parameters and Measurements read back
MEAS	MEASUREMENTS	Measurements
TRAN	N/A	Not used on ADF Series models
CONF	CONFIGURATION	Configuration Screens
SYST	SYSTEM	System Settings, Interface Configuration and Calibration

Table 6-1: Available Menu Keys

Following sections cover each aspect of the front panel screen and parameters in more detail.

6.4 PROG – PROGRAM & MEASUREMENTS Screen

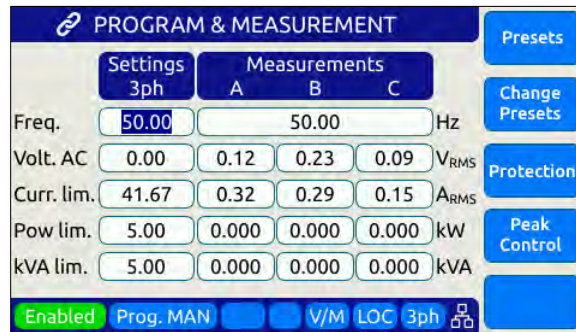

All output parameters can be set from the PROGRAM & MEASUREMENTS screen. This screen has a list of available parameters on the main PROGRAM screen. Each parameter can be changed by highlighting the field and either slewing the value using the shuttle knob or entering a value using the numeric key pad. The difference between these two data entry modes is that slewing causes the output to change as the knob is turned while using the keypad allows one or more parameters to be preset to a new value which won't become active until the "Apply All" soft key or the ENTER key is pressed.

Thus to slew a value, proceed as follows:

1. Use shuttle to move the active field to the parameter you want to slew.
2. Press the shuttle once to enter the slew mode. The selected field will be highlighted.



3. Use the shuttle to increment (*clockwise*) or decrement (*counterclockwise*) the selected parameter. Note that these changes take effect immediately resulting in the active output slewing up or down.
4. To set commonly used standard AC voltage values, the preset value soft keys shown in the screen above may be used as well to directly set a pre-defined value. The settings for these pre-set soft keys can be changed from factory defaults shown here as needed.

Note: This assumes the output is ON. If the output is OFF, the new value will be in effect and apply at the output as soon as the output is turned ON.

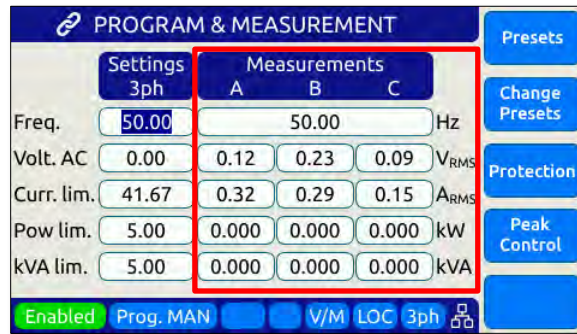

Measurements can be seen on same screen so any changes made to output settings will be reflecting in the measurement read-back portion of this screen.

To change one or more values but not change the actual output till all parameters are preset, proceed as follows:

1. Use shuttle to move the selected field to the parameter you want to change.
2. With the parameter field selected, enter a new value using the numeric keypad. Note that all fields are now shown with a gray background (Edit mode active)
3. Once satisfied with the new value, move to the next parameter you want to change.
4. Once all values are set to the new desired set value, press the ENTER key or the "Apply All" soft key.

6.4.1 Power On Settings

The ADF Series will normally power up with the last settings in effect at turn-off.

This behavior is determined by the the "SOURce:INITial" command. This feature is active by default. This makes the ADF "remember" all the settings after cycling power.

This mode can be disabled by using the remote control command:

SOURce:INITial 0

This setting is retained in non-volatile (FLASH) memory. For set points affected, refer to Section 8.7.1, "Source Configuration Programming Commands" on page 211.

6.4.2 PROGRAM Output Parameters

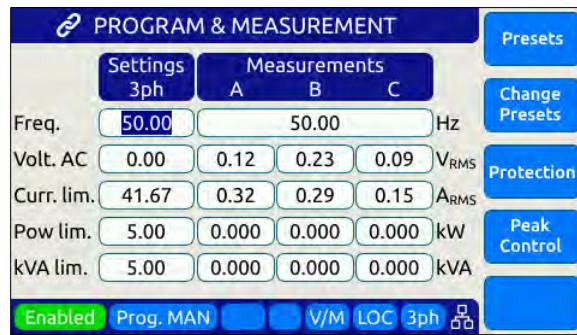

Figure 6-2: PROGRAM Screen

The two data entry methods described apply to the parameters on the PROGRAM & MEASUREMENTS screen. This includes those shown in the table below.

PARAMETER	Range	Unit	Description
Frequency	45 - 500 ¹	Hz	Output frequency
Voltage AC	0 – 300 ²	V rms	AC output
Voltage DC	0 – 425 ³	V dc	DC output (Option D)
Current limit	0 to Max	A rms	RMS Current Limit
Power limit	0 to Max	W	True Power Limit
kVA limit	0 to Max	VA	Apparent Power Limit

Table 6-2: Available Output Parameters on PROGRAM screen

- Note 1:** On ADF Series models with Option F, frequency setting range is 15 -1200 Hz
- Note 2:** On ADF Series models with Option V, max voltage setting can be higher than 300V
- Note 3:** On ADF Series models with Option D, max voltage setting is 425Vdc

Each screen has up to five soft keys on the right hand side of the display. These may change as the selected parameter changes. To move between parameter fields in any screen, use the shuttle knob. To change a parameter, press the shuttle knob and then adjust the value by turning the shuttle. When done, press the shuttle to exit edit mode.

6.4.3 Three Phase Models – Phase Linked or Unlinked Data Entry

On three phase ADF models, the user can choose to enter voltage, current limit or power limit values that are the same for all phases (**LINKED** mode) or set different values for each phase (**UNLINKED** mode). The mode can be selected using the **PHASE** key on the front panel located in the lower right corner of the front panel below the LOCAL key.

A chain link symbol  will be displayed in the upper left corner of the LCD display when in LINKED mode. In LINKED mode, data set for phase A is automatically applied to phases B and C (Except for phase angle settings which are never linked).

In UNLINKED mode, the user needs to set each phase setting separately allowing different values to be set for each phase.

Sample PROGRAM screens using UNLINKED versus UNLINK mode are shown below.



6.4.4 Phase Rotation / Phase Sequence

Phase rotation(aka sequence) in three-phase mode is fixed. The default phase rotation of the ADF is the same as that of legacy PPS UPC controllers.

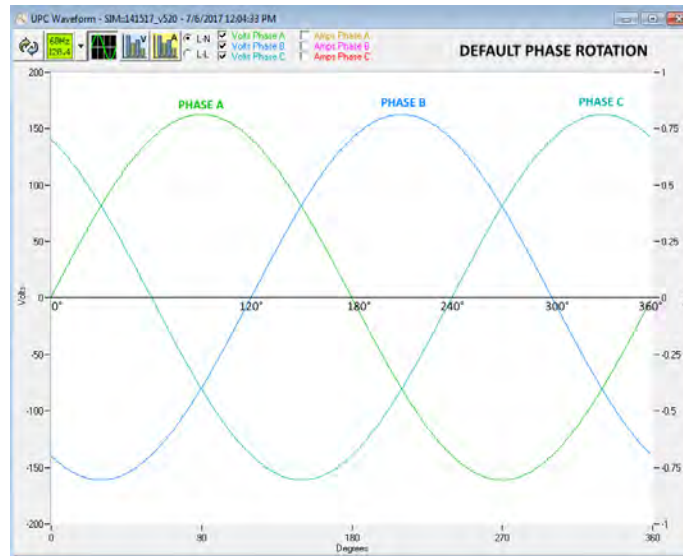

Figure 6-3: Three Phase AC mode Default Phase Rotation

Phase rotation in three-phase mode can be reversed if needed by swapping output connection wires B and C to the load.

The reversed phase rotation is shown in the figure below for reference.

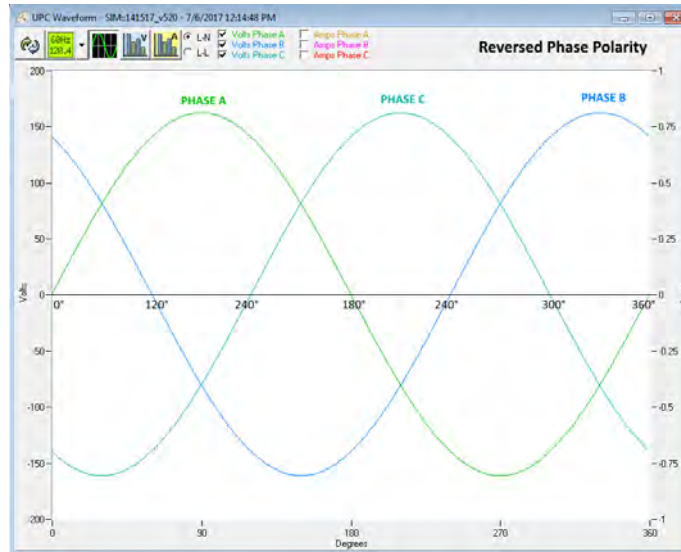

Figure 6-4: Three Phase AC mode Reversed Phase Rotation

6.4.5 Direct Data Entry - Presets

Values for Frequency, Voltage, Current, Phase and Power can be entered directly using the numeric keypad. Position the flashing cursor on the field for which you want to enter a new setting value. Once a field is selected, press the first key of the value you want.

As soon as you enter the first digit, the soft keys will display commonly used values for the parameter you are changing. For example, if you are on the Frequency fields, presets for 50 Hz, 60 Hz and 400 Hz will appear. On ADF Series models with Option F, an additional 800 Hz preset soft key will be available.

If you are on the Voltage AC field, voltage presets for single phase (on single phase ADF models) or LN and LL voltage preset soft keys will appear. A Low Voltage Range selection will be offered as well allowing you to lock in the virtual low range, which limits AC voltage entry to no more than 150 Vac. This is illustrated on the image below.

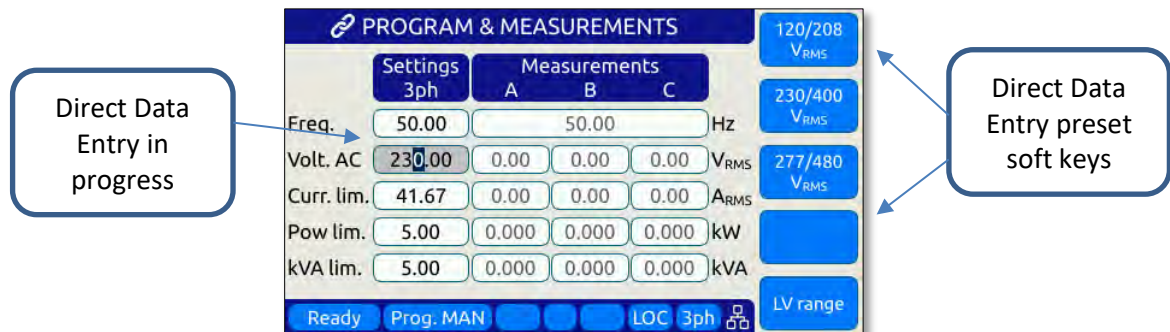

6.4.6 Customizing Output Programming Preset Soft Key Values

The power source allows the user to set up his own preferred or often used output programming values in place of the factory default selections. This can be done from the SYST menu by selecting the UNIT CONFIGURATION 2 OF 2 screen and pressing the “User Presets” soft key.

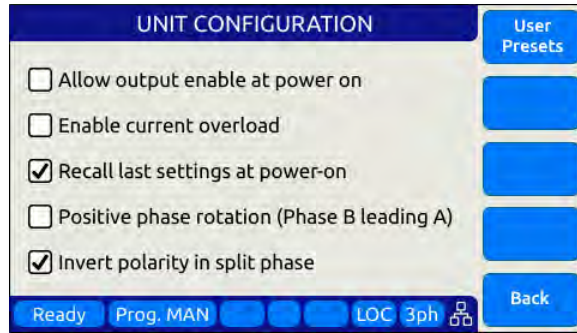

For details on change any available pre-set soft key value, refer to Section 6.7.6, “USER PRESETS Screen” on page 118.

6.4.7 Changing Shuttle Programming Resolution

Once entering EDIT mode on any programmable field – by double clicking the shuttle knob – the parameter value can be slewed by turning the knob. The setting resolution can be changed as needed. If a large value change is needed, a lower resolution will result in a faster change, e.g. changing voltage 10V per click or 1V per click. For a very small change, a 0.1V or 0.01V change per click may be more appropriate.

The selected resolution is reflected by the blinking character when in edit slew mode. To change the position and thus resolution, use the keypad numeric keys. The lowest number keys will select the smallest increment/decrement setting. The higher number keys will select a larger increment/decrement setting.

The table bellows maps the keypad keys to the resolution setting.

Key Pad Key #	Position	Resolution
1 or 2		0.01
3		0.1
4		1
5		10
6, 7, 8 or 9		100
7, 8, 9		1000

Table 6-3: Changing Programming Resolution

6.4.8 PROGRAM & MEASUREMENTS Soft Keys



The following five soft keys are available on the main PROGRAM screen.

SOFT KEY	Description
Presets (SK1)	<p>Changes all soft keys to up to five preset values that may be used to change the selected parameter to any of the preset values shown on the soft key labels. This provides a quick way to set commonly used values. It is also possible to reprogram these presets to user specific values. Refer to Section 6.4.5, “Customizing Output Programming Preset Soft Key Values” on page 92 for details.</p> <p>The following presets are offered for the parameters listed:</p> <p>Frequency 50Hz, 60Hz, 400Hz (800Hz, 1200Hz with Option F)</p> <p>Voltage AC 115V, 230V, 300V</p> <p>Current limit MAX, 15A, 4A, PEAK CURRENT</p> <p>Power limit MAX, 4kW, 2kW, 1kW</p> <p>kVA limit MAX, 4kVA, 2kVA, 1kVA</p>
Change Preset (SK2)	Access UNIT CONFIGURATION screen to change preset values.

SOFT KEY	Description
<p>Protection (SK3)</p>	<p>Displays the POWER AND CURRENT PROTECTIONS screen shown below.</p> <div data-bbox="711 373 1291 703" style="border: 1px solid black; padding: 5px; margin: 10px 0;"> </div> <p>There are two check box options and one data field on this screen that can be set as needed:</p> <p>Enable RMS current protection Activates the programmable current limit function at the value set in the main program screen</p> <p>Enable power protection Activates power protection at W and kVA set points.</p> <p>Trip time: Determines how long the power source will allow the power level setting to be exceeded before tripping off.</p>
<p>Peak Current (SK4)</p>	<p>Displays the Peak Current protection screen. This protection function is separate from the RMS current limit function. By setting the peak current protection mode, the maximum peak current is limited by the power source to the programmed level. This is done on a cycle by cycle basis. Note that a minimum setting applies as described in section 6.4.8, next page.</p> <div data-bbox="711 1354 1291 1684" style="border: 1px solid black; padding: 5px; margin: 10px 0;"> </div> <p>The level can be set using the shuttle or key pad. To enable or disable this function, scroll to the “Enable peak current protection” check box and press the shuttle to toggle on or off.</p>

Table 6-4: PROGRAM screen soft keys

6.4.9 Peak Current Protection Minimum Setting

The programmable peak current protection feature allows the user to limit the peak current that is applied to the EUT. In order to do this, the power source has to clamp the output voltage. The power source will do so when the set limit is exceeded on a switching cycle by switching cycle bases. There are some practical considerations to take into account as some of the current delivered by the power source can be absorbed by the internal output filters.

If the peak current limit value is set too low, it may prevent the power source from delivering the programmed output voltage at higher frequencies. Even if no load is connected to the power source, some reactive power is required to generate the output voltage. This reactive current will be limited by the peak protection level set point so a minimum value applies. The formula that determines the minimum set value for peak current protection is:

$$I_{pk} > 1 A + Vac_setpoint * 0.09 * Freq_setpoint \text{ (in kHz).}$$

This formula applies in three phase mode for ADF models of 15kVA and below. For example, with an output AC voltage setting of 230Vac and a frequency setting of 1000 Hz, the minimum set value would be:

$$I_{pk} \text{ min} = 1 + 230 * 0.09 * 1 = 21.7 A_{peak}$$

If the set value is below this level, the following two conditions will occur:

A) The voltage measured at the output will be less than desired.

Example 1:

- Frequency 400Hz.
- Voltage 120Vac.
- Peak current limit 1A.
- The voltage measured at the output will be limited to 25.6Vrms

Example 2:

- Frequency 400Hz.
- Voltage 120Vac.
- Peak current limit 2A.
- The voltage measured at the output will be 54.6Vrms

Example 3:

- Frequency 400Hz.
- Voltage 120Vac.
- Peak current limit 3A.
- The voltage measured at the output will be 83.22Vrms

The higher the frequency and the AC voltage set points are, the lower the measured voltage at the output will be unless the peak current protection level is set high enough to prevent this condition.

- B) An Error event will be triggered in the error and event queue in order to notify the user. The error message is:

"Peak current limit setting is too low for the desired voltage and frequency."

as shown in the screen capture below.

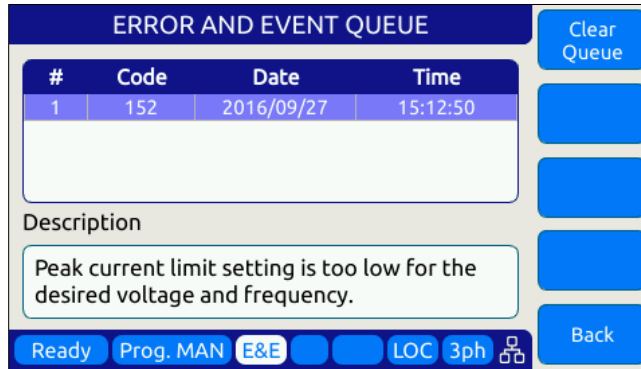

6.4.10 Sine Waveform

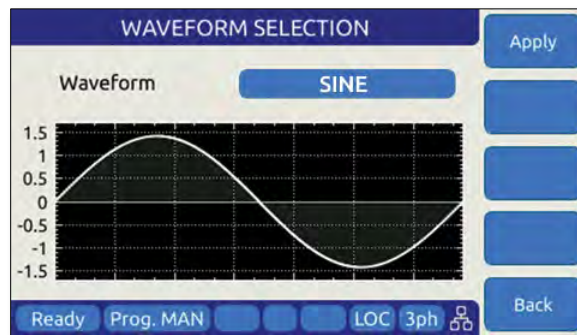

The ADF Series® support only sinewave output.waveforms. Preview of the sinewave is shown on the LCD screen.

Name	Description	Image	Notes
1	SINE		Standard sine wave.

Table 6-5: ADF Series® Sine Waveform

6.4.11 AUTO RMS Function – Steady State

The AUTO RMS mode, if enabled, causes the AC voltage output value to be calculated as a true RMS voltage of the waveform selected. This means the output RMS voltage will remain at the programmed level regardless of a change in waveform shape. This may or may not be what the user intends. For example, adding a transient spike on a sine wave as part of a user defined waveform will cause the overall RMS value to increase so the sinewave portion of this user defined waveform will be attenuated somewhat when used.

When AUTO RMS is disabled, RMS calculation of substituted waveforms does not occur so the output RMS voltage may change from the set value if the waveform selected for output is not a sine wave. This mode is preferred if switching to a user waveform that has a different mathematical RMS value from a sine wave should NOT result in the output voltage amplitude being adjusted to maintain the same RMS level as with a sine wave. As in the previous example, adding a spike or a dip in part of the sinewave will not affect the output amplitude of the sinewave portion.

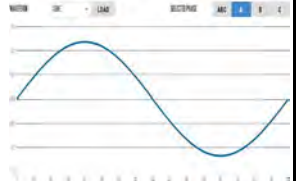
Note: The setting of the AUTO RMS mode is important when CSC mode is used as CSC mode uses the measured output RMS voltage to adjust the output to maintain voltage regulation.

This mode can be set by sending the `[SOURCE:]WAVEFORM:AUTORMS` command over one of the Digital control interfaces.

The following examples illustrate the different behaviors between AUTO RMS mode ON and OFF.

6.4.11.1 AUTO RMS ON Mode:

In the example below a, 100Vrms sine wave is swapped for a half wave rectified ac waveform. The RMS value of this non-sinusoidal waveform is 1.414x that of a sine wave so the peak value is increased to maintain a 100Vrms output voltage with this wave shape. Not that there is a considerable amount of DC offset present as well due to this non-symmetrical waveform.

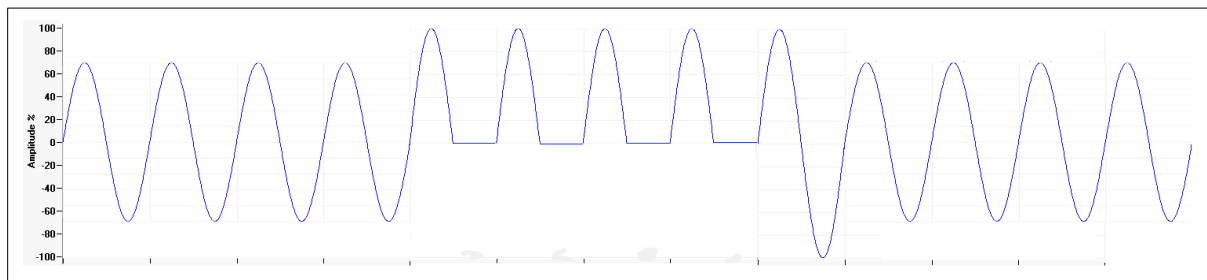

6.4.11.2 AUTO RMS OFF Mode:

Same waveform example but this time with AUTO RMS mode OFF results in no change to output peak voltage but the actual RMS voltage during these four cycles is only 70.7Vrms instead of the 100Vrms programmed setting.

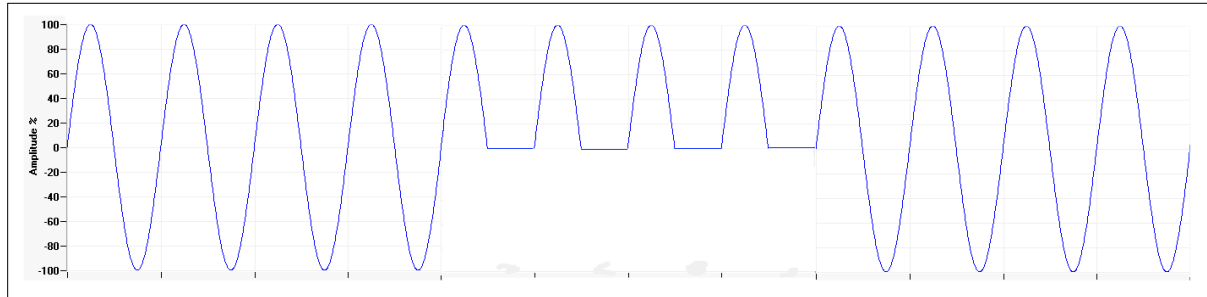

Note: In UPC Compatibility mode, this mode is always enabled.

6.4.12 Option V - Extended AC Voltage Range Operation

The standard AC voltage range maximum setting for line-to-neutral voltage programming is 300Vac rms. This setting is equivalent to 520V line-to-line in three-phase mode.

For ADF Series models configured with the V Option (Option V), extended voltage operation to 320V or even 333V is supported with some restrictions. These restrictions are determined by the maximum voltage setting programmed:

6.4.12.1 300 – 305 V - Max Voltage 305V_{L-N} / 528V_{L-L}

This setting reflects a 10% over voltage for 277V_{L-N} / 480V_{L-N} nominal voltage applications.

Restrictions

- **Frequency Range:** 45.00 – 100.00 Hz.
- **Phase Mode:** Available in single, split and three phase modes.
- **Output Power:**
 - Three phase – Full power (no restriction).
 - Single and Split phase – Maximum power 3kVA/kW per phase per ADF unit.

6.4.12.2 305 – 312 V - Max Voltage 312V_{L-N} / 540V_{L-L}

This setting reflects a 30% over voltage for 240V_{L-N} / 415V_{L-N} nominal voltage applications.

Restrictions

- **Frequency Range:** 45.00 – 100.00 Hz.
- **Phase Mode:** Available in three-phase mode only.
- **Output Power:**
 - Three phase – Maximum power 3kVA/kW per phase per ADF unit.
 - Single and Split phase – Not available.

6.4.12.3 Higher Voltage Settings (Requires Option V)

For applications requiring more than 312V L-N, refer to the “SOURce:VOLTage:EXTend” command in the programming section of this manual. Only available if Option V has been installed.

6.4.12.4 Extended Voltage Range Power Limit Setting

Applicable output power restrictions as stated above will result in adjustment of the programmed kW and kVA power limits in the PROGRAM screen. This occurs automatically when programming an AC voltage value higher than 300 and is based on the value set and the standard available max. power level of the ADF model used. An Event Message is generated to notify the user of this restriction.

6.4.12.5 Accessing Extended Voltage Ranges

To enable higher voltage operation, the user must first set the MAX USER LIMIT for Vac to more than 300.00V. Values from 300.00 to 312.00 will be accepted.



Figure 6-5: Enable Vac extended operating range to 312Vac

Once the Voltage AC MAX user limit has been set to a higher value, the PROGRAM screen will accept a Volt AC setting up to this new value.

When a value above 300 is entered in any of the available Vac setting fields, an Error & Event (E&E) message will be generated in the Error and Event Queue. The E&E field in the bottom status bar will blink to indicate a message is available. Note that the power limit fields will automatically update as needed to indicate the power limit.

For applications requiring more than 312V L-N, refer to the “SOURce:VOLTage:EXTend” command in the programming section of this manual.

6.4.12.6 Power Limit Adjustment Notification Messages

The message queue is accessible from the SYSTEM MENU.

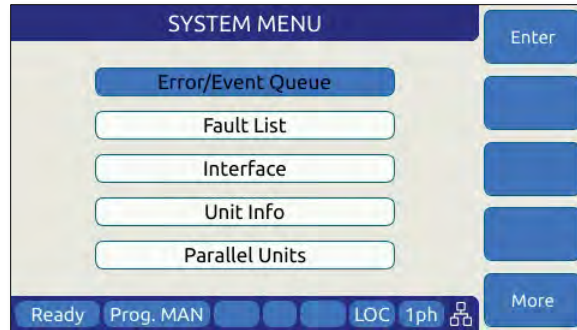

A sample of the relevant Event Message is shown below. The “Webpage interface” indicates the setting change was triggered from a browser connection. Alternative sources are “Front Panel Interface” or “Remote Interface”.

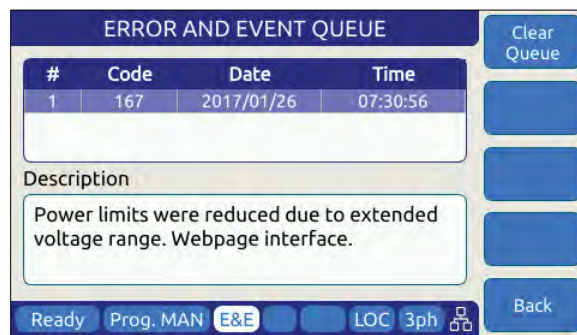

Note: Disable extended AC voltage range access, set the voltage AC MAX user limit setting back to 300.00 in the USER LIMITS screen.

6.5 MEAS – MEASUREMENTS Screens

The MEAS menu key displays the first of two measurement screens. Measurement screens are used to display measurement values taken at the output of the AC power source.

The measurements screen layouts differ between single phase and multiphase mode. If the power source is configured for single-phase mode operation, only the single phase measurement screens are available. When in three phase mode, the user can change screens between all three phases or one phase at a time using the PHASE key located below the Output ON/OFF key or by pressing the “Individual Phase” soft key (SK5).

6.5.1 Measurements Screen by Phase

The different measurement screen layouts are shown below.

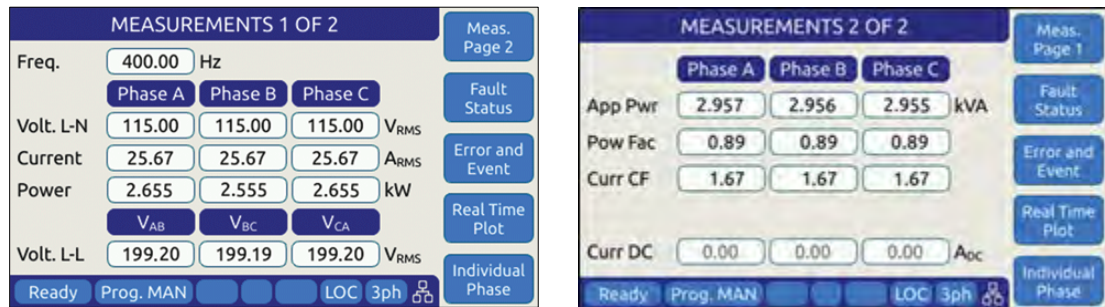

Figure 6-6: Three Phase Measurement Screens

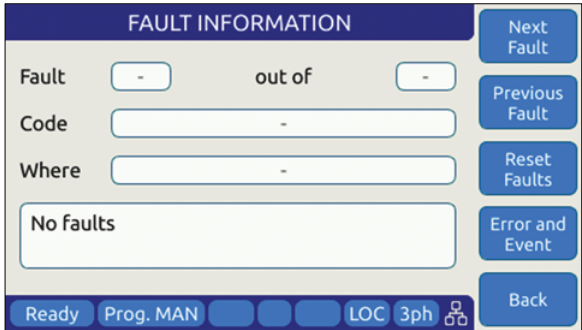

Figure 6-7: Single Phase Measurement Screens for Phase A and B

Note: The individual phase display screens contain all measurement parameters on one screen so there is one screen for each phase.

6.5.2 Three Phase Measurement Screen Soft Keys

The following five soft keys are available on the three-phase measurement screen.

SOFT KEY	Description								
Meas. Page 2 (SK1)	The first soft key allows toggling between the two available measurement screens. The same can be accomplished by pressing the MEAS button on the left hand side of the LCD display.								
Fault Status (SK2)	<p>Pressing this soft key displays the Fault Status screen. The fault status shows a history list of possible error or fault messages that have been recorded by the power source.</p> <div data-bbox="621 642 1198 968" data-label="Image">  </div> <p>The following soft keys are available to review or clear fault messages:</p> <table data-bbox="621 1079 1380 1270"> <tr> <td>Next Fault</td> <td>Scrolls to the next available fault message if any.</td> </tr> <tr> <td>Previous Fault</td> <td>Scrolls to the previous fault message if any.</td> </tr> <tr> <td>Reset Faults</td> <td>Clear Fault Buffer</td> </tr> <tr> <td>Clean and Refresh</td> <td>Clears displayed faults and updates</td> </tr> </table>	Next Fault	Scrolls to the next available fault message if any.	Previous Fault	Scrolls to the previous fault message if any.	Reset Faults	Clear Fault Buffer	Clean and Refresh	Clears displayed faults and updates
Next Fault	Scrolls to the next available fault message if any.								
Previous Fault	Scrolls to the previous fault message if any.								
Reset Faults	Clear Fault Buffer								
Clean and Refresh	Clears displayed faults and updates								
(SK 4)-	N/A								

SOFT KEY	Description										
<p>Real Time Plot (SK3)</p>	<p>Display strip chart of voltage, current or both against time. This provides a trend plot of any available measured parameter.</p>  <p>The following soft keys are available to control the time plot:</p> <table border="0"> <tr> <td>Start</td> <td>Starts time plot.</td> </tr> <tr> <td>Select Meas.</td> <td>Select parameters to display</td> </tr> <tr> <td>Zoom Y</td> <td>Zoom both X and Y axis</td> </tr> <tr> <td>Save</td> <td>Saves plot data to memory device</td> </tr> <tr> <td>Clean and Refresh</td> <td>Auto-scaled Y axis</td> </tr> </table>	Start	Starts time plot.	Select Meas.	Select parameters to display	Zoom Y	Zoom both X and Y axis	Save	Saves plot data to memory device	Clean and Refresh	Auto-scaled Y axis
Start	Starts time plot.										
Select Meas.	Select parameters to display										
Zoom Y	Zoom both X and Y axis										
Save	Saves plot data to memory device										
Clean and Refresh	Auto-scaled Y axis										
<p>Individual Phase (SK5)</p>	<p>Displays the individual phase measurement screen for Phase A. To select other screens, use the PHASE key on the front panel or the first three soft keys on the measurement screen.</p>										

Table 6-6: Three Phase Measurement Screen Soft Keys

6.5.3 Individual Phase Measurement Screen Soft Keys

The following five soft keys are available on the individual phase measurement screens.

SOFT KEY	Description
Phase A (SK1)	Displays individual phase measurement screen for phase A if not already displayed.
Phase B (SK2)	Displays individual phase measurement screen for phase B if not already displayed.
Phase C (SK3)	Displays individual phase measurement screen for phase C if not already displayed.
Real Time Plot (SK4)	<p>Display strip chart of voltage, current or both against time. This provides a trend plot of any available measured parameter.</p>  <p>The following soft keys are available to control the time plot:</p> <ul style="list-style-type: none"> Start Starts time plot. Select Meas. Select parameters to display Zoom Y Zoom both X and Z axis Save Save plot data to memory device Clean and Refresh Auto-scaled Y axis
Phase ABC (SK5)	Displays the three-phase measurement screen.

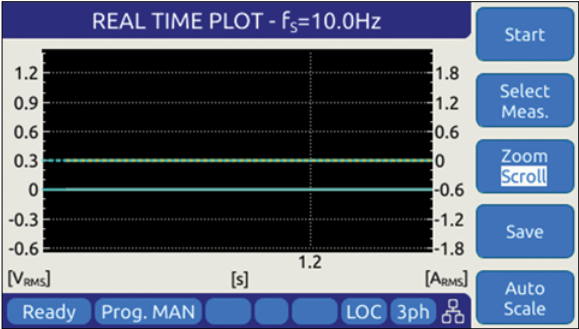
Table 6-7: Individual Phase Measurement Screen Soft Keys

6.5.4 Measurement Screen Soft Keys

The following five soft keys are available on the two three-phase measurement screens.

SOFT KEY	Description										
Datalogger (SK1)	<p>The Datalogger soft key allows setting the measurement data logging memory type to be selected, sample rate and no. of samples to be logged to memory. To use a usb memory stick (32GB max), insert it in one of the two USB ports on the front panel and select either USBA1 or USBA2. Only memory devices found will be selectable in addition to the default internal RAM (volatile) memory.</p> 										
Real Time Plot (SK2)	<p>Display strip chart of voltage, current or both against time. This provides a trend plot of any available measured parameter.</p>  <p>The following soft keys are available to control the time plot:</p> <table border="0"> <tr> <td>Start</td> <td>Starts time plot.</td> </tr> <tr> <td>Select Meas.</td> <td>Select parameters to display</td> </tr> <tr> <td>Zoom or Scroll</td> <td>Zoom both X and Y axis</td> </tr> <tr> <td>Save</td> <td>Saves plot data to memory device</td> </tr> <tr> <td>Auto Scale</td> <td>Auto-scale the Y axis (Amplitude)</td> </tr> </table>	Start	Starts time plot.	Select Meas.	Select parameters to display	Zoom or Scroll	Zoom both X and Y axis	Save	Saves plot data to memory device	Auto Scale	Auto-scale the Y axis (Amplitude)
Start	Starts time plot.										
Select Meas.	Select parameters to display										
Zoom or Scroll	Zoom both X and Y axis										
Save	Saves plot data to memory device										
Auto Scale	Auto-scale the Y axis (Amplitude)										
Next Screen (SK5)	<p>This soft key allows toggling between the two available measurement screens. The same can be accomplished by pressing the MEAS button on the left hand side of the LCD display.</p>										

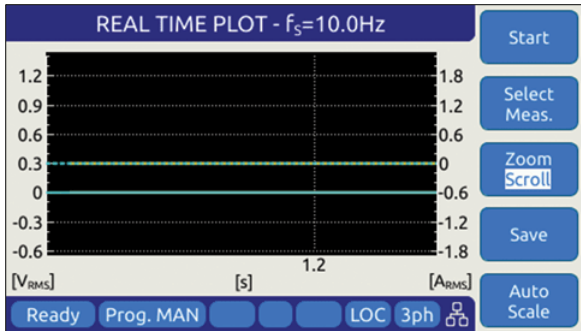
Table 6-8: Measurement Screen Soft Keys

6.5.5 Measurement Data Logging

Logging measurement data is easy to do using the Datalogging function. Files are saved in a comma separated value text file which is easily imported into MS Excel or other programs for analyzer and / or display purposes.

Destination memory defaults to internal RAM allowing log files to be downloaded to browsers or local drives using the web server SYSTEM -> MEMORY BROWSER menu entry.

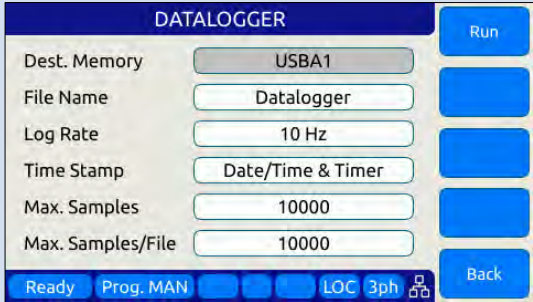
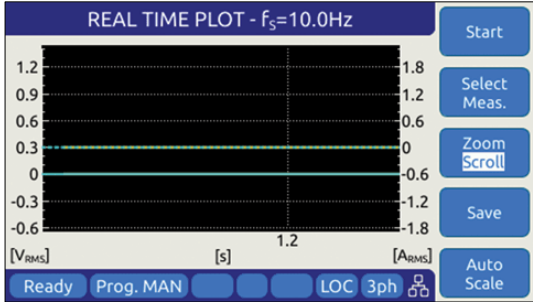
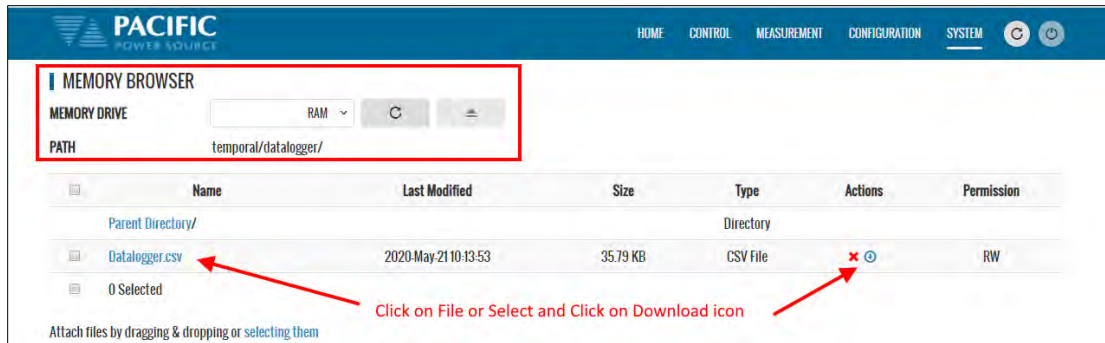

A small datalogging file sample is shown here for reference.

```
Date & Time,Timer,Frequency,Voltage VLL ACDC A-B,B-C,C-A,Voltage VLL AC A-B,B-C,C-A,Voltage VLL DC A-B,B-C,C-A,Voltage LN ACDC A,B,C,Voltage LN AC A,B,C,Voltage LN DC A,B,C,Current RMS A,B,C,Current DC A,B,C,Power A,B,C,App. Power A,B,C,Power Factor A,B,C,Peak Current A,B,C,Crest Factor A,B,C,
21/4/2020 10:13:17.647,0.00,60,207.846,207.845,207.846,207.846,207.845,207.846,0.0015717,0.000892723,0.000678978,120,120,120,120,120,5.74293e-05,0.00162913,0.000736408,0.0961562,0.0658469,0.0389105,0.00917411,0.00100751,-0.00516246,0.00012973,0.000672549,0.00066903,0.0115388,0.00790161,0.00466924,0,0,0,0.249016,0.199247,0.126655,0,0,0,
21/4/2020 10:13:17.748,0.101,60,207.845,207.846,207.847,207.845,207.846,207.847,0.000484911,0.000716525,0.000231614,120,119.999,120.001,120,119.999,120.001,0.000291418,-0.000193493,0.000523032,0.0963041,0.0660525,0.0392375,0.00873799,0.000840356,-0.0050699,0.000142419,0.000692023,0.000528912,0.0115565,0.0079262,0.00470855,0,0,0,0.245361,0.199247,0.126651,0,0,0,
21/4/2020 10:13:17.847,0.200,60,207.845,207.843,207.844,207.845,207.843,207.844,0.00195489,0.000834307,0.0027892,120,119.999,119.998,120,119.999,119.998,0.00201776,6.2867e-05,-0.00077144,0.0957361,0.0658142,0.0392642,0.00805068,0.000924351,-0.00582215,0.000124226,0.000720164,0.000534704,0.0114883,0.00789763,0.00471161,0,0,0,0.249,0.195608,0.128863,0,0,0,
21/4/2020 10:13:17.947,0.300,60,207.844,207.847,207.846,207.844,207.847,207.846,7.05616e-05,0.000486062,0.000556624,119.998,119.999,120.002,119.998,119.999,120.002,0.000496289,0.000425727,-6.03351e-05,0.0967671,0.0652786,0.0393575,0.00906719,0.000913487,-0.0051749,0.000184154,0.00060259,0.00057676,0.0116118,0.00783339,0.00472296,0,0,0,0.252638,0.192,0.126645,0,0,0,
```

Using Excel to select several measurement columns allows for easy plotting of trends. For example VLN for A, B and C (Y-axis) against no of samples (X-axis) as shown below.

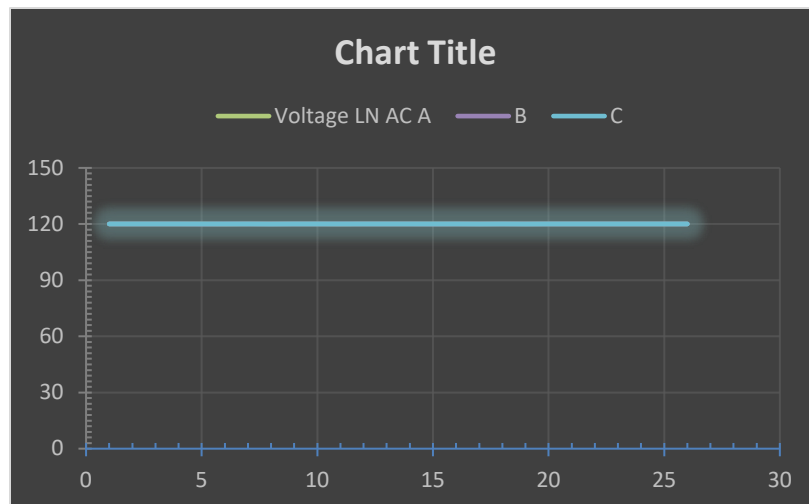

6.6 TRAN- TRANSIENTS Screens

This functionality is not available on ADF Series models.

6.7 CONF – CONFIGURATION Screens

The CONFIGURATION screens 1 & 2 allow setting of secondary parameters functions. These include the following operation aspects:

- Configuration

Pressing the **CONF** key will display the CONFIGURATION screen as shown on the left below.

The configuration screens are as follows:

- UNIT CONFIGURATION 1 OF 2**:
 - Form: Three (ABC)
 - Voltage range: High
 - Mode: AC
 - Update phase: 0.00 Deg
 - Coupling: XFMR (400V)
- USER LIMITS**:
 - Voltage AC: 0.00 to 600.00 V_{RMS}
 - Frequency: 15.00 to 1200.00 Hz
- RAMP TIME & SLEW RATE**:
 - Ramp time: Disabled ms
 - Slew rate control is active.
 - Voltage AC: 10.00 V_{RMS}/ms
 - Frequency: 5.00 Hz/ms
- PROGRAM MEMORY**:
 - Current program register #: MANUAL
 - Manual
 - Recall from register #: 1
 - Save setup to register #: 1
 - Power-on recall register #: Disabled
- CSC CONFIGURATION**:
 - Continuous self calibration
 - Fault on saturation
 - Max CSC gain: 1.15

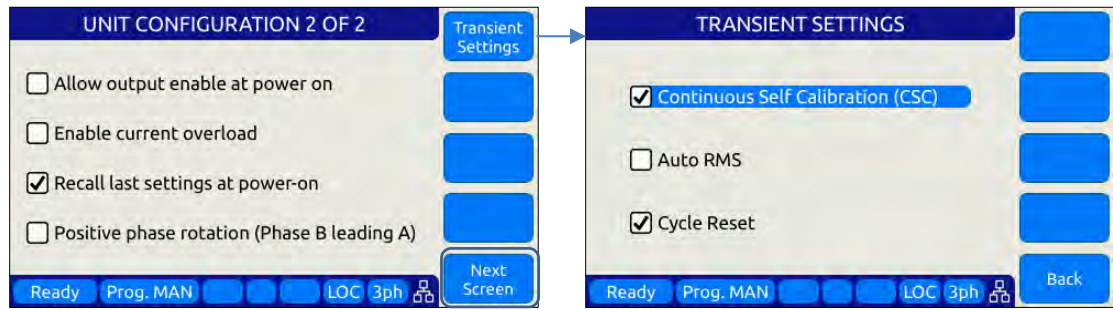

All other system related screens can be accessed using the SYST menu key. (Refer to Section 6.7.6).

6.7.1 UNIT CONFIGURATION Screens

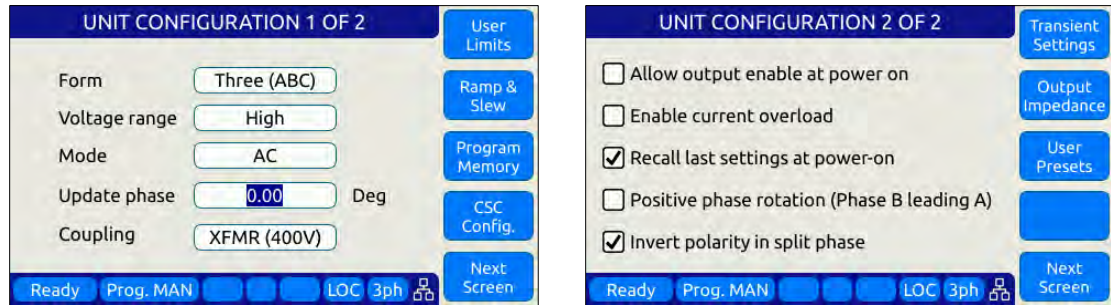

The following settings can be changed from the UNIT CONFIGURATION screens:

UNIT CONFIGURATION 1 OF 2-----

- Form** This field displays the phase mode of operation. On 3150ADF models this is always “Three (ABC)”. On 1150ADF models this is always “Single (A)”
- Voltage Range** Although the power source uses a constant power mode voltage range to allow operation using a single 300Vac voltage range only, the end user can simulate a low voltage range by setting this field to Low. Doing so limits programming of any output voltage to no more than 150Vac or half the available voltage range of the power source. If operation to 300Vac is desired, this field should be set to High. This effectively simulates a conventional dual voltage range model.
- Mode** Displays the output mode (AC).
- Update Phase** Sets the phase angle at which output voltage and frequency changes will take place on phase A. This setting applies to both steady state output changes and to the start of a transient program execution. It also applies to the OUTPUT ENABLE and DISABLE function key on the front panel. Changes on phases B and C will take place at the same moment in time but at phase angles that are shifted from phase A by the phase angles programmed for phase B and C.
- Coupling** This field selects the output coupling mode of the power source. Unless an optional output transformer is installed with the power source (T Option), this field is always fixed to DIRECT. If the optional transformer is installed, the ADF model number will show “ADFT” to indicate the presence of the output transformer. To use the output transformer coupled range, selected XFMR (xxxV) in this field. The voltage indication may vary based on the transformer ration

of the installed output transformers.

Note: In either coupled mode, only **AC** voltage programming is possible.

Access to other utility screens is available from the UNIT CONFIGURATION screen through the soft keys. The table below lists the available soft keys on the UNIT CONFIGURATION screen.

SOFT KEY	Description
User Limits (SK1)	Displays SETUP MENU screen. Refer to section 6.7.2
Ramp & Slew (SK3)	Displays SLEW RATE MENU screen. Refer to section 6.7.3
Program Memory (SK2)	Displays PROGRAM MEMORY screen. Refer to section 6.7.4
CSC Config. (SK4)	Display CSC setting screen
Next Screen (SK5)	Toggle to alternate UNIT CONFIGURATION screen

Table 6-9: Available UNIT CONFIGURATION 1 screen soft keys

UNIT CONFIGURATION 2 OF 2 -----

Allow Output Enable at Power On This mode if set, causes the output to turn on at power up.

Enable Current Overload Current Overload mode allows the power source to provide more than the nominal max. RMS current (around 30 percent more) for a short period (up to 2 seconds). When enabled, the user can set the CURR:LIM 30% higher than what this mode off. For example in a stand-alone 3150ADF unit in three phase mode (FORM 3), RMS output current can be up to 55A when the continuous output limit is 41.7A. A warning message will be display notifying the user this mode is being enabled.

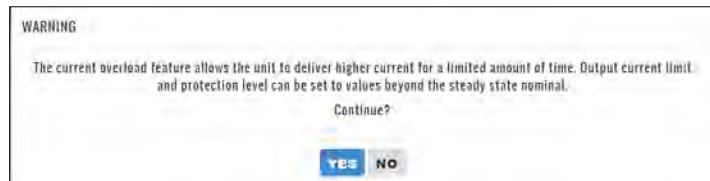

Recall last settings at power-on When checked, this mode will cause the last settings that were in effect when the power source was last turned off to be recalled at power on. This allows a user to resume operation without having to set up again between power on/off events.

Positive phase rotation When checked, the phase rotation in three phase mode will be set to A -> C -> B corresponding to positive phase rotation for three phase AC motors. To select negative phase rotation, uncheck this option.

Access to other utility screens is available from the UNIT CONFIGURATION screen through the soft keys. The table below lists the available soft keys on the UNIT CONFIGURATION screen.

SOFT KEY	Description
Transient Settings (SK1)	Display Transient Configuration Settings
Output Impedance (SK2)	Program Output Impedance R and L values.
User Presets (SK3)	Access to user defined preset value settings for output programming soft keys
Next Screen (SK5)	Toggle to alternate UNIT CONFIGURATION screen

Table 6-10: Available UNIT CONFIGURATION 2 screen soft keys

6.7.2 USER LIMITS SETTINGS Screen

This screen allows programming user defined voltage and frequency upper and lower limits to prevent an operator from accidentally programming output settings that could be damaging to a unit under test.

For example, when testing a 50 Hz transformer, a lower frequency limit setting of 47 would prevent output frequency programming of values that could cause the transformer to saturate.

This applies to voltage where a high voltage value could damage a unit under test that was not designed to handle high AC input voltage.



Figure 6-8: USER LIMIT SETTINGS Screen

The following parameters can be set from this screen:

Voltage AC Lower and Upper Vrms set limits for AC programming.

Frequency Lower and Upper limits for Frequency programming.

The soft keys on the USER LIMITS SETTINGS screen provide access to additional functionality as listed in the table below.

SOFT KEY	Description
Apply (SK1)	Accepts new settings and returns to previous screen.
Cancel (SK2)	Returns to the previous screen.
-	
-	
Back (SK5)	Returns to the previous screen.

Table 6-11: Available USER LIMITS SETTINGS screen soft keys

6.7.3 RAMP TIME & SLEW RATE SETTINGS Screen

This screen allows programming of the update ramp time or individual voltage and frequency slew rates, which are applied when changing output settings. Ramp time and slew rate settings are mutually exclusive so Ramp time must be disabled in order to program individual voltage, frequency and phase update rates. Setting a slew rate other than the maximum value allows voltage and frequency changes to occur at a controlled rate of change. The Ramp time when enabled applies to any setting change equally.



Figure 6-9: RAMP TIME & SLEW RATE SETTINGS Screen

The following parameters can be set from this screen:

- Ramp time** Sets the time (in msec) over which output changes will take place. For the time set, output changes will ramp from their previous set value to the new set value. When **DISABLED**, changes will occur at the programmed slew rate settings in the SLEW RATE SETTING screen, as both cannot be in effect at the same time. Settings Slew Rate settings provide control over individual parameters whereas the RAMP TIME setting applies to all parameters (F, Vac, Vdc and Phase) changes equally.
- Voltage AC** AC Voltage slew rate in Vrms per msec. Available range is 0.01 Vrms/ms through 300 Vrms/ms.
- Frequency** Frequency slew rate in Hz per msec. Available range is 0.01 Hz/ms through 1200 Hz/ms.

NOTE: Programmed Slew Rate settings will only take effect when the RAMP TIME setting is **DISABLED**.

The soft keys on the SLEW RATE SETTINGS screen provide access to additional functionality as listed in the table below.

SOFT KEY	Description
Apply All (SK1)	Applies all changes made (highlighted in grey) and returns to previous screen.

SOFT KEY	Description
Cancel All (SK2)	Cancels all changes (highlighted in grey), sets slew rates back to prior settings and returns to previous screen.
Enable Ramp T.	Enables Ramp time, disables Slew rate settings
Enable Slew R.	Enable Slew Rate settings, disables Ramp time
Back (SK5)	Returns to the previous screen.

Table 6-12: Available RAMP TIME & SLEW RATE SETTINGS screen soft keys

6.7.4 PROGRAM MEMORY Screen

The Program Memory menu allows saving and recalling of instrument setups in non-volatile memory registers. Setups include all steady state parameters, limits, operating modes and transient list if programmed.

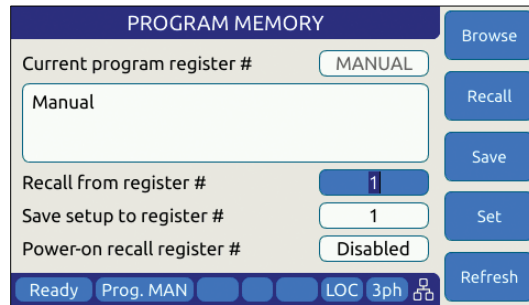

Figure 6-10: PROGRAM MEMORY screen

There are 10 setup registers numbered from 1 through 10. Use the shuttle to select either the Recall or Save field and press the shuttle to enter edit mode. Once the correct number is selected, press ENTER to confirm.

Recall from register #

Recalls setup from selected register. If register is empty, an error message will be displayed and no setting will be recalled.

Note: If a register location is empty, an error message will be displayed.

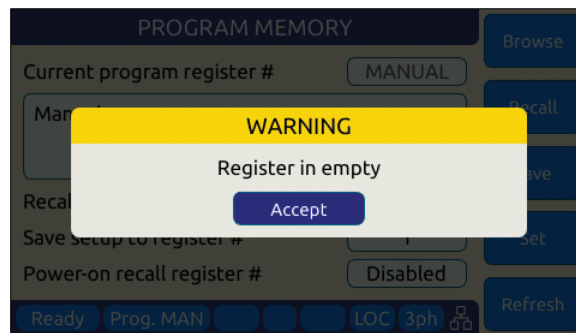

Save setup to register #

Saves setup in effect to selected register number. If this register already contained a saved setup, it will be overwritten.

Power recall register #

Determines which register number setup is recalled at power-up. Using this feature, the user can determine the power-on default settings of the power source.

The soft keys on the PROGRAM MEMORY screen provide access to additional functionality as listed in the table below.

SOFT KEY	Description
Browse(SK1)	Allows browsing for a particular register’s content.
Recall (SK2)	Recalls selected Register setup content
Save (SK3)	Saves setup to selected Register
Set (SK4)	Sets output to selected Register content
Refresh (SK5)	Return to previous screen

Table 6-13: Available SLEW RATE SETTINGS screen soft keys

6.7.5 CSC CONFIGURATION Screen

The CSC CONFIGURATION menu allows the Continuous Self Calibration mode to be enabled. This feature is used to improve load regulation of the power source by continuous measurement of the output phase voltage(s) and adjusting the internal set points as needed to maintain close to zero load regulation. If the CSC is unable to get the output to the set point, an error will be generated. This error can be disabled by unchecking the “Fault on saturation” check box.

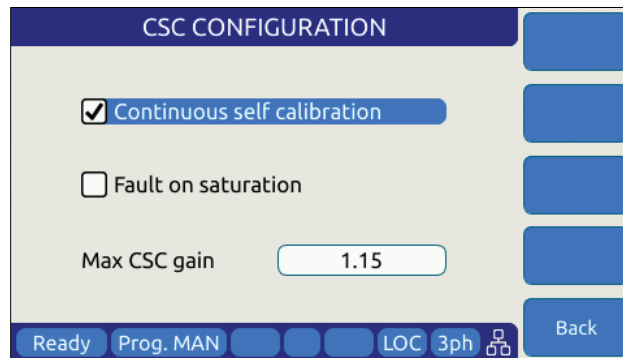

Figure 6-11: CSC CONFIGURATION screen

The soft keys on the CSC CONFIGURATION screen are listed in the table below

SOFT KEY	Description
-	
-	
-	
-	
Back (SK5)	Return to previous screen

Table 6-14: Available CSC CONFIGURATION screen soft keys

6.7.6 USER PRESETS Screen

The USER PRESETS screen allows the soft key set values for output programming that appear in the PROGRAM screen to be changed to setting values preferred by the user.

Presets can be defined for the following output settings:

- VOLTage[:AC]
- FREQuency
- CURRent:LIMit
- POWer:LIMit
- KVA:LIMit

6.7.6.1 AC Voltage Soft keys



6.7.6.2 Frequency Soft keys

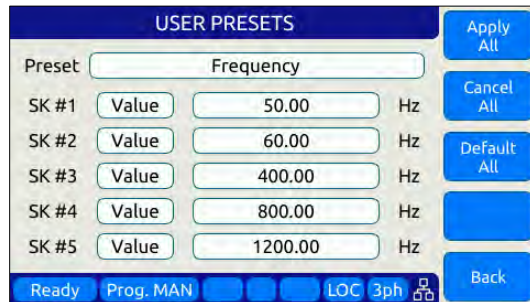

Note: Preset value higher than 500.00 Hz are only available on ADF Models with Option F.

6.7.6.3 Current Limit Soft keys



6.7.6.4 Power and VA Limit Soft keys



For each parameter, the user will be prompted to confirm soft key value setting changes. See dialog to the right. ►

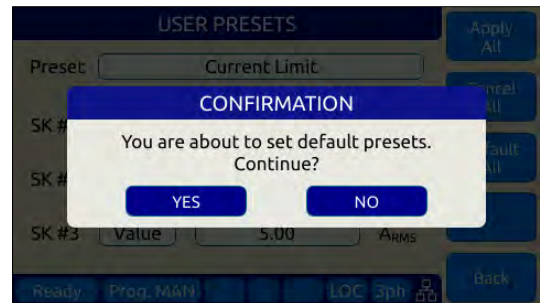

SOFT KEY	Description
Apply All (SK1)	Applies values entered by user.
Cancel All (SK2)	Cancel all changes made.
Default All (SK3)	Sets all soft key settings for selected parameter to factory defaults.
-	
Back (SK5)	Refreshes screen

6.8 SYST – SYSTEM Screens

The System screens allow setting of secondary system level functions that are used less often than the first four screens. This generally involves setting system level operation modes and parameters to tailor the instruments operation to the user’s specific requirements and operating environment. These include the following areas:

- Remote Control Interfaces
- System level settings, logs and firmware updates
- Calibration
- Parallel Operation
- Options if any

Pressing the **SYST** key will display the first of two CONFIGURATION screens as shown below.

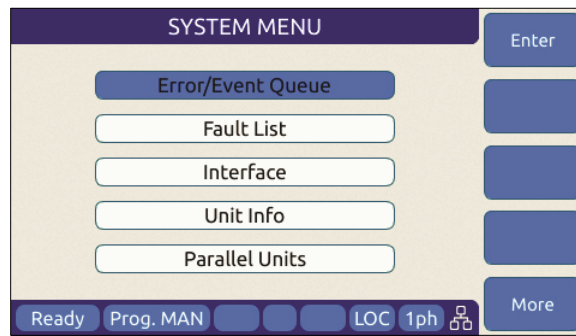

Figure 6-12: SYSTEM MAIN MENU 1

The **More** soft key will allow moving back and forth between the two main SYSTEM screens.

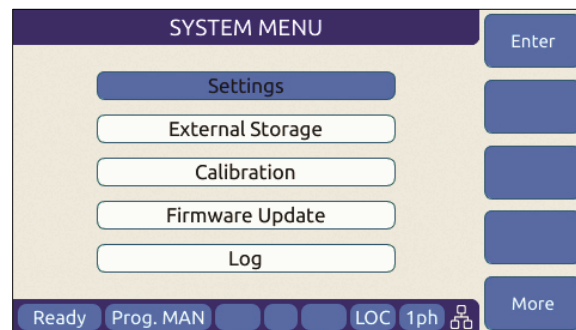

Figure 6-13: SYSTEM MAIN MENU 2

Selections on each screen are made by scrolling through the available entries using the shuttle knob. Pressing the **Enter** soft key, ENTER key or shuttle will display the selected highlighted entry screen.

6.8.1 SYSTEM MENU 1

The first SYSTEM MENU allows for selection of the following functions:

- Error/Event Queue Screen
- Fault Information Screen
- Interface Settings Screen
- Unit Information Screen
- Connected Units Screen
- SCPI Console

Each screen is covered in subsequent sections.



6.8.2 SYSTEM MENU 2

The second SYSTEM MENU allows for selection of the following functions:

- System Settings Screen
- Memory Management Screen
- Calibration Screen
- Firmware Update Screen
- Remote Support Screen

Each screen is covered in subsequent sections.



6.8.3 ERROR / EVENT QUEUE Screen

The Error and Event queue shows the history of any errors or events that have occurred since the last time the error queue was cleared.

The error queue can be cleared using a SCPI command over any of the remote control interfaces or by pressing the “Clear Queue” soft key while on this screen.

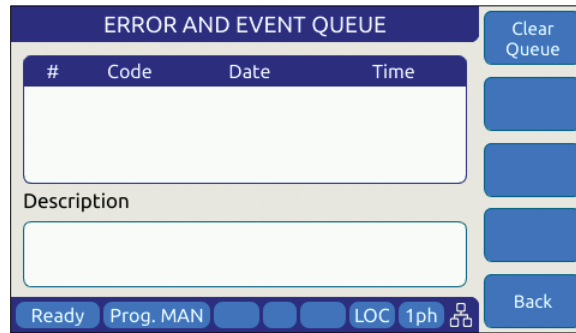

Figure 6-14: ERROR & EVENT QUEUE Screen

6.8.4 FAULT INFORMATION Screen

The fault list shows any logged internal operation faults. This information may be useful when trouble shooting any issues with the power source. In that even, customer service may request this information from the end user or request access to the instrument through the LAN interface for further diagnostics.

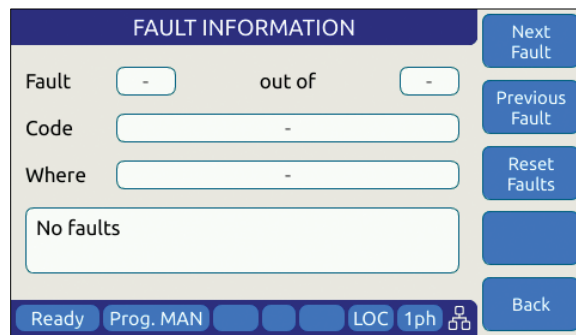

Figure 6-15: FAULT INFORMATION screen

6.8.5 INTERFACE Screen

The INTERFACE SETUP screen allows access to the setup parameter of any of the available remote control interfaces.

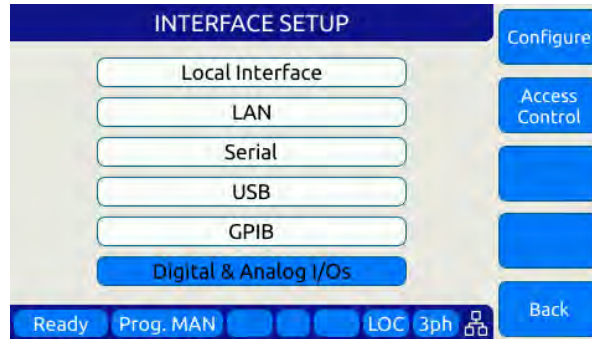

Figure 6-16: INTERFACE SETUP Screen

Available selections are:

- Local Interface (Relates to front panel operation)
- LAN – Ethernet Interface Setup
- Serial – RS232 Serial Interface Setup
- USB – USB Interface Setup
- GPIB – GPIB Interface Setup
- Digital & Analog I/O Setup

Each section is covered in subsequent sections.

6.8.5.1 LOCAL INTERFACE 1 OF 2

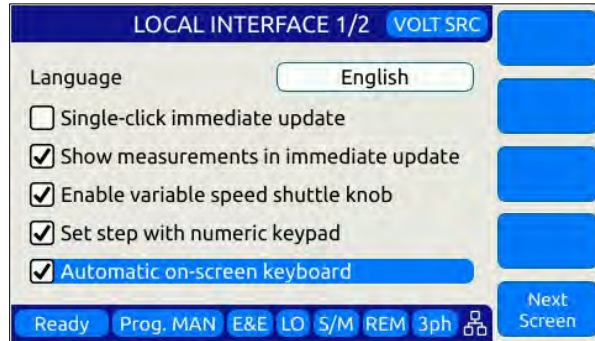

Several aspects of front panel operation can be configured by the user from this screen. This relates primarily to the language selection and operation of the shuttle knob, which has three distinct functions:

1. Scrolling values up or down
2. Single Click push function
3. Double Click push function

Parameters available to set are as follows:

Language

Available language selections are:

- English (default factory setting)
- Chinese.

Language can be switched by pressing the shuttle while on the language field and scrolling between available selections. Press ENTER to confirm selection.

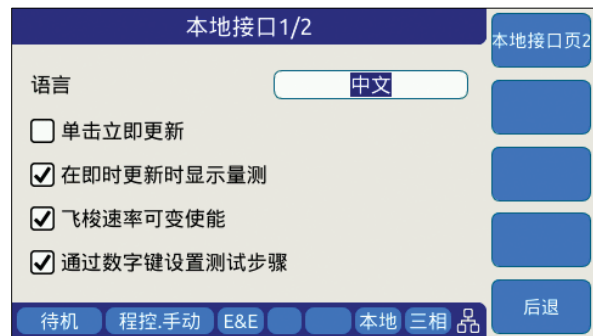

Single-Click Immediate Mode

Enters Immediate Mode upon single depression of shuttle knob. Immediate mode means value changes occur immediately on the output of the power source. When unchecked, a double click of the shuttle knob is required to enter this mode.

- Show Measurements in Immediate Mode** When checked, entering immediate mode will result in the Measurement screen being display with the changing parameter showing in the title bar. This allows monitoring of all output measurements while slewing voltage, current of frequency.
- Enable variable speed shuttle knob** When selected, the speed of rotating the shuttle knob will increase the step size of the parameter being changed. If unchecked, changes occur at a fixed step size (resolution).
- Set step with numeric keypad** When set, the numeric keypad can be used to increment or decrement the step size of the shuttle knob. Digits 9 to 1 our use to change from largest step size (9) to smallest step size (1) and any step size in between.
- Automatic on-screen keyboard** This selection enables the on-screen Qwerty keyboard pop-up when the scroll knob is pressed once. When turned OFF, it is still available but requires double clicking the knob. This touch keyboard allows entering of alpha numeric parameters and also supports number value entries. See next section for details.

The following soft keys are available from the LOCAL INTERFACE setup screen:

SOFT KEY	Description
Local Inter. Page 2. (SK1)	Toggle to LOCAL INTERFACE 2 OF 2 screen
-	
-	
-	
Back (SK5)	Returns to previous screen

Table 6-15: Available USER INTERFACE screen soft keys

6.8.5.2 TOUCHSCREEN KEYBOARD

The on-screen Touchscreen Keyboard features allow entry of alpha numeric values such as names in text entry fields from the front panel. It pops up when the scroll knob is pressed once is set to on or double clicked when set to off in the LOCAL INTERFACE 1 OF 2 Screen.

It is mainly intended for use in text entry fields as the numeric keypad is always available for numeric entries. These are several keyboards available and the default type depends on the data entry field the cursor is on when the shuttle knob is pressed. The number of text characters in each keyboard is limited by the field type.

Key Descriptions

The following keys are supported:



1. Shift: Allows switching between lowercase and uppercase letters, numbers and symbols.
2. 123/ABC: Allows switching from letters to numbers and symbols or vice versa.
3. Return: Places the cursor at the end of the text.
4. Backspace: Deletes the previous character depending on the cursor position
5. Apply: Closes the keyboard and apply text to the field.
6. Clear: Clears all text.
7. Arrows: Allows moving through the text.
8. Cancel: Discards text and close the keyboard

Available Qwerty keyboard Types:

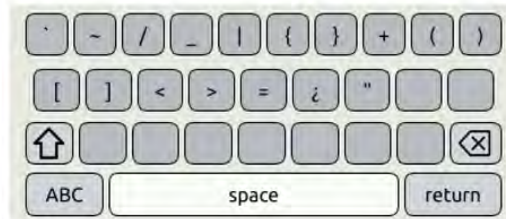
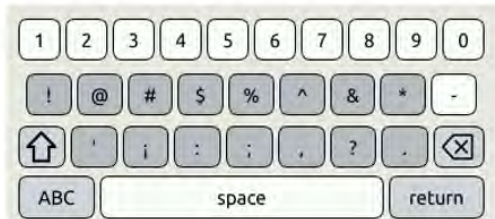
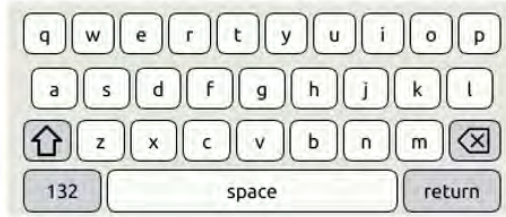
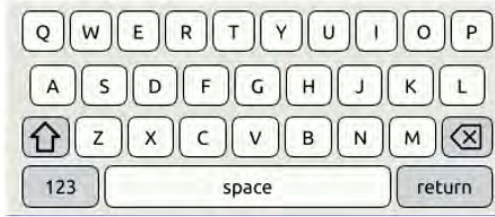

Web Browser Front Panel Mode.

The same on-screen keyboard functions are available from the Web browser interface via LAN or USB as shown below.

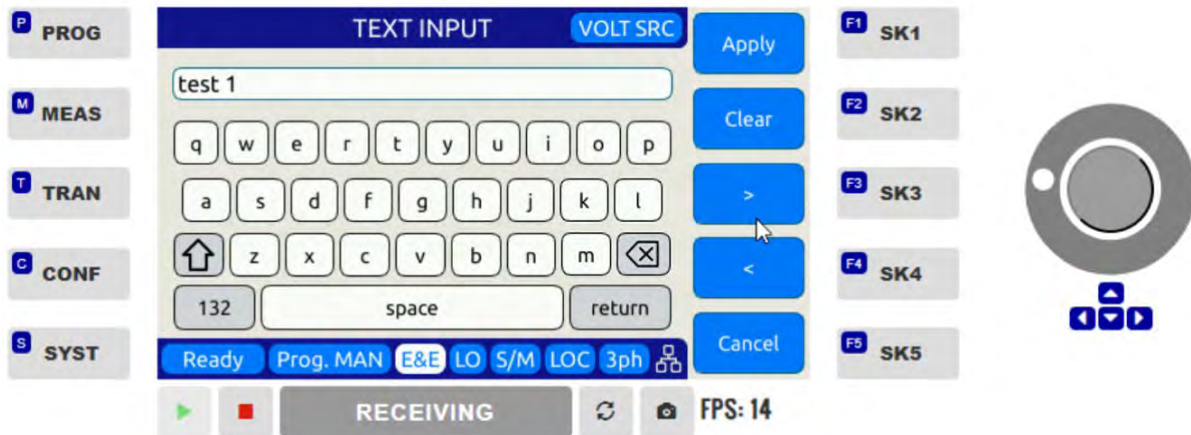

6.8.5.3 LOCAL INTERFACE 2 OF 2

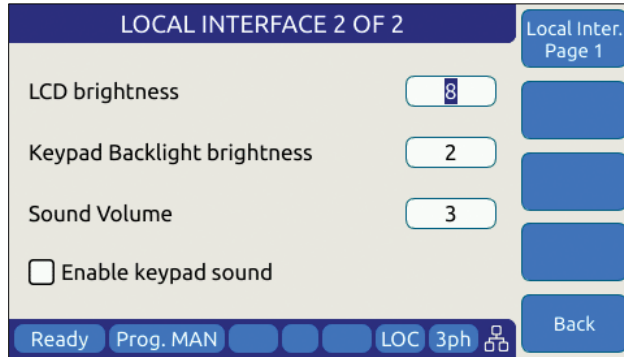

Several aspects of front panel operation can be configured by the user from this screen. These settings relate primarily to visual and audible user interface aspects:

1. LCD brightness
2. Keyboard Backlight
3. Sound Levels

Parameters available to set are as follows:

LCD brightness	Adjusts the LCD display backlight brightness. Range is 0-9.
Keypad Backlight brightness	Adjusts the keyboard backlight brightness. Range is 0-9.
Sound Volume	Adjusts the loudness of the keyboard and message beeps.
Enable keypad sound	Enables or Disables audible beeps when operating the keyboard.

The following soft keys are available from the LOCAL INTERFACE setup screen:

SOFT KEY	Description
Local Inter. Page 1. (SK1)	Toggle to LOCAL INTERFACE 1 OF 2 screen
-	
-	
-	
Back (SK5)	Returns to previous screen

Table 6-16: Available USER INTERFACE screen soft keys

6.8.5.4 LAN (ETHERNET) INTERFACE SETUP Screen

The LAN INTERFACE SETUP screen allows configuring the Ethernet interface for use with your local area network (LAN) and is accessed from the INTERFACE SETUP screen.



WARNING



Do NOT connect the RJ45 LAN (Ethernet) connector of the power source to a PoE (Power over Ethernet) port as the DC voltage will damage the LAN interface.

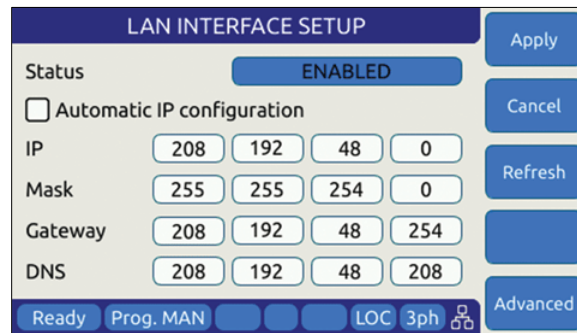

Figure 6-17: ETHERNET INTERFACE SETUP Screen

This screen is used to configure the Ethernet interface for your local area network.

Note: You may need to consult your network administrator to set up this interface correctly.

The following parameters can be set on this screen:

- Automatic IP Configuration** Select this mode if your network has a domain name server running. An IP address will be assigned by the DNS each time the power source is turned on.
- IP** IP address setting. This address must be unique to your network segment. Consult your network administrator if you are not sure about this setting.
- Mask** IP mask setting. This mask must be correct for your network. Consult your network administrator if you are not sure about this setting.
- Gateway** Gateway address setting. Consult your network administrator if you are not sure about this setting.
- DNS** Domain Name Server address setting. Consult your network administrator if you are not sure about this setting.
- Port** Port socket address. For message based instruments like this power source, this setting is typically 5025.

The following soft keys are available from the ETHERNET INTERFACE SETUP screen:

SOFT KEY	Description
Apply (SK1)	Accepts new settings and returns to previous screen.
Cancel (SK2)	Returns to the previous screen.
Refresh (SK3)	
-	
Advanced (SK5)	Access detailed LAN Interface Setting screen

Table 6-17: Available ETHERNET INTERFACE SETUP screen soft keys

6.8.5.5 SERIAL INTERFACE SETUP Screen

The SERIAL INTERFACE SETUP screen allows configuring the RS232 serial interface and is accessed from the “INTERFACE SETUP” screen.

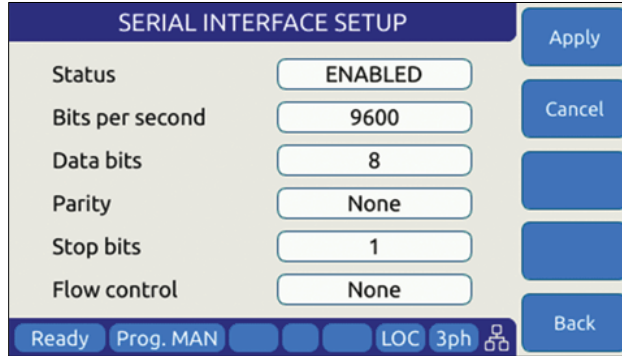

Figure 6-18: SERIAL INTERFCE SETUP Screen

The following parameters can be set on this screen:

- Bits per second** Sets the baud rate. Available settings are 9600, 14400, 19200, 38400, 57600 or 115200.
- Data bits** Sets the number of bits per frame. Available settings are 7 or 8 bits
- Parity** Sets parity check to either odd, even or none.
- Stop bits** Sets the number of stop bits as either 1 or 2.
- Flow control** Sets handshake mode to None or Xon/Xoff

The following soft keys are available from the SERIAL INTERFACE SETUP screen:

SOFT KEY	Description
Apply (SK1)	Accepts new settings and returns to previous screen.
Cancel (SK2)	Returns to the previous screen.
-	
-	
Back (SK5)	Returns to the previous screen.

Table 6-18: Available SERIAL INTERFACE SETUP screen soft keys

6.8.5.6 USB INTERFACE SETUP Screen

The USB INTERFACE SETUP screen allows configuring the USB interface and is accessed from the INTERFACE SETUP screen.

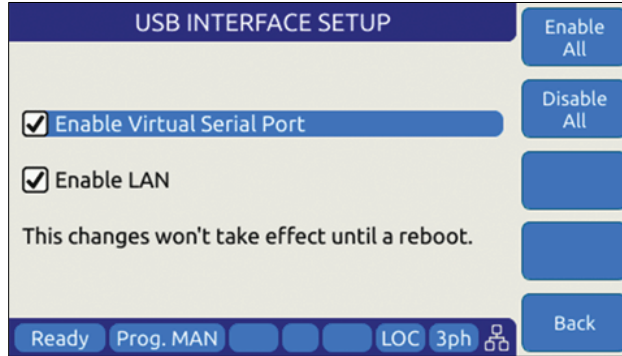

Figure 6-19: USB INTERFACE SETUP Screen

The following settings can be configured on this screen:

- Enable Virtual Serial Port** Enables or disables PC control using a virtual serial port driver.
- Enable LAN** Enables or disables the LAN (Ethernet) Interface IP emulation mode, which supports use of the embedded LXI web server. The virtual IP address of the USB-LAN emulation mode is fixed at 192.168.123.1.

Note: Any changes made to this screen will NOT take effect until the power source has been completely powered off and back on. (Re-boot).

The following soft keys are available from the USB INTERFACE SETUP screen:

SOFT KEY	Description
Enable All (SK1)	Set all check boxes
Disable All (SK2)	Clear all check boxes
-	
-	
Back (SK5)	Returns to the previous screen.

Table 6-19: Available USB INTERFACE SETUP screen soft keys

6.8.5.7 GPIB INTERFACE SETUP Screen

The GPIB INTERFACE SETUP screen allows configuring the GPIB interface and is accessed from the INTERFACE SETUP screen.

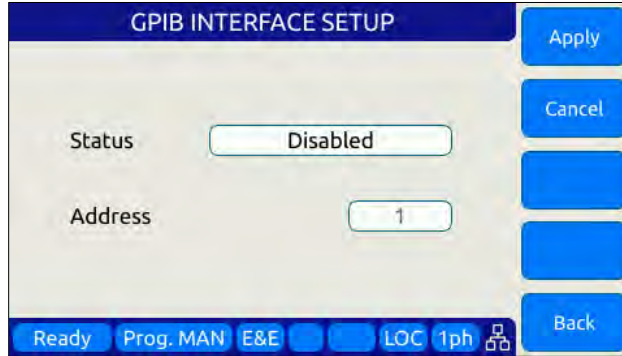

Figure 6-20: USB INTERFACE SETUP Screen

The following settings can be configured on this screen:

- Status** Enables or disables the GPIB interface. Disable when not in use to avoid erroneous interrupts.
- Address** Sets GPIB bus address. Available range is from 1 through 30. Default factory setting is address 1.

The following soft keys are available from the GPIB INTERFACE SETUP screen:

SOFT KEY	Description
Apply (SK1)	Accepts new settings and returns to previous screen.
Cancel (SK2)	Returns to the previous screen.
-	
-	
Back (SK5)	Returns to the previous screen.

Table 6-20: Available GPIB INTERFACE SETUP screen soft keys

6.8.5.8 DIGITAL & ANALOG I/Os SETUP Screen

The Digital & Analog IOs SETUP screen allows configuring the auxiliary I/O interfaces and is accessed from the INTERFACE SETUP screen.

For further details, refer to Section 7.3, “Auxiliary I/O” on page 152.

6.8.5.9 REMOTE INHIBIT SETUP Screen

The REMOTE INHIBIT SETUP screen allows configuring the remote output control input for various modes of operation. Once set, this setting is retained in non-volatile memory so the selection persists between input power cycles.

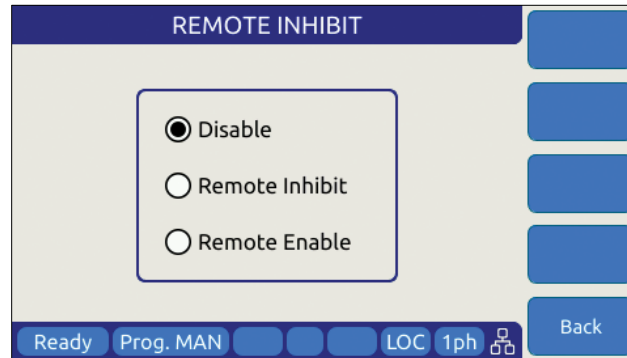

Figure 6-21: REMOTE INHIBIT Setup Screen

There are three modes of operation for this input: remote inhibit and remote enable.

1. **Disable mode:** In this mode, the Remote Inhibit inputs are not active so this function is turned off. No short between the RI pins is required to enable the output in this mode.
2. **Remote Inhibit mode:** The two pins have to be shorted for the output to be enabled from the front panel or remote command. This is a necessary but not a sufficient condition to enable the output. If the output is enabled and the remote inhibit connection is open, a fault is generated. This mode is recommended for interlock safety applications such as safety cages and test fixture interlocks.
3. **Remote Enable mode:** The output can be enabled by shorting these two pins, regardless of the output enable command/button. It is a sufficient condition to enable the output.

6.8.5.10 REMOTE SHARING

Remote sharing of the power source is provided using one of two protocols:

Samba: Samba is a free software re-implementation of the SMB networking protocol. Server Message Block (SMB), also known as Common Internet File System (CIFS) operates as an application-layer network protocol for providing shared access to resources miscellaneous communications between nodes on a network.

FTP: File Transfer Protocol. FTP is built on a client-server model architecture using separate control and data connections between the client and the server.

Note: Either one or both may be chosen. It is strongly recommended to set a custom password to prevent unauthorized access to the power source.

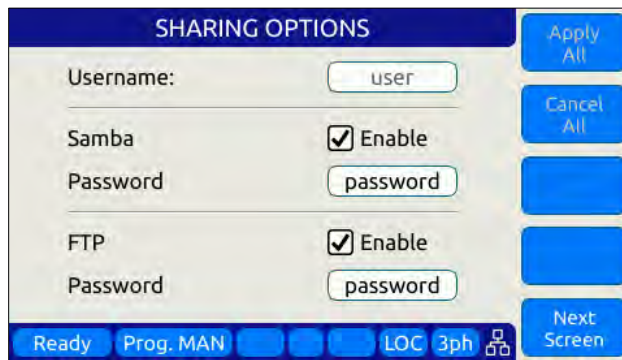

The screenshot shows a 'SHARING OPTIONS' dialog box with the following fields and controls:

- Username:** Input field containing 'user'.
- Samba:** Checkmark is checked, with the label 'Enable'.
- Password:** Input field containing 'password'.
- FTP:** Checkmark is checked, with the label 'Enable'.
- Password:** Input field containing 'password'.

On the right side of the dialog, there are four buttons: 'Apply All', 'Cancel All', an unlabeled blue button, and 'Next Screen'. At the bottom of the screen, there is a status bar with buttons for 'Ready', 'Prog. MAN', 'LOC 3ph', and a 'Next Screen' button.

6.8.6 UNIT INFORMATION Screen

The UNIT INFORMATION screen is an information only screen that contains information about the power source and is accessed from the SYSTEM SETTINGS screen using the “Unit info” soft key (SK3).

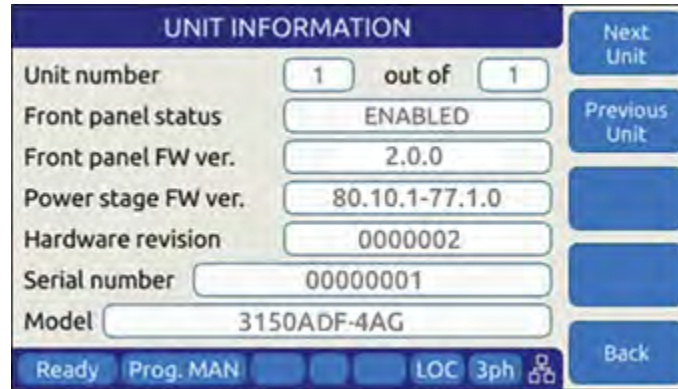

Figure 6-22: UNIT INFORMATION Screen

The following information is provided on this screen:

Unit Number	Shows the position of this unit in a string of paralleled power sources. For a stand-alone power source, the display will show 1 of 1.
Front panel status	Shows the status of the front panel. Only the MASTER unit in a multi-unit system will have its front panel enabled.
Front panel FW ver.	Firmware revision of the front panel control processor.
Power stage FW ver.	Firmware revision of the power stage processors.
Hardware revision	Hardware build revision.
Serial number	Unit Serial number.
Model	Model number, typically 1xxxADX or 3xxxADX where xxx = power rating.

Note: This information is for information purposes only and cannot be changed by the operator.

The following soft keys are available from the UNIT INFORMATION screen:

SOFT KEY	Description
Next Unit (SK1)	If this unit is part of a parallel system, information on the next unit in the chain will be displayed.
Previous Unit (SK2)	If this unit is part of a parallel system, information on the previous unit in the chain will be displayed.
-	
-	
Back (SK5)	Returns to the previous screen.

Table 6-21: Available UNIT INFORMATION screen soft keys

6.8.7 CONNECTED UNITS Screen

The CONNECTED UNITS screen controls the behavior of this power source in a multi-unit parallel or series system where two or more power sources are either paralleled or in series (AFXS models) to provide higher power level systems.

This screen is accessed from the SYSTEM SETTINGS screen using the “Connected Units” entry.

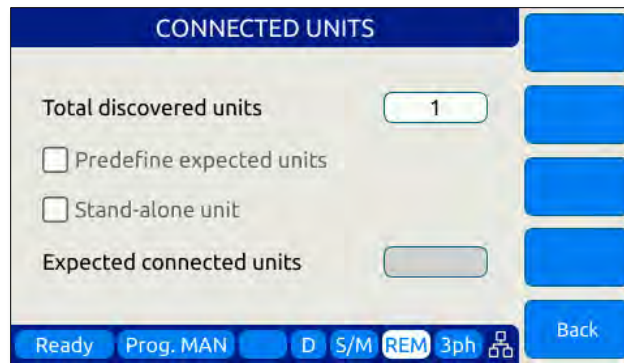

Figure 6-23: PARALLEL UNITS Screen

The first field shows the number of units found at power up on the system bus. A value of 1 means this is a stand-alone unit (not part of a larger system).

The following settings can be configured on this screen:

- Predefine expected units** Tells the power source how many total units to expect to find on the system interface bus at power up. If the number found is less than the number expected as set by the user, one or more units may not be powered up or missing. Leaving this check box off means the system will operate with the number of units found, regardless.
- Stand-alone unit** Set this check box if you want the power supply to operate as a stand-alone unit, even if it is connected to the system interface bus. To do so, you must make sure the outputs of this power source are not connected to any other units’ outputs.
- Expected parallel units** Use this field to enter the number of expected units only if the “Predefine expected units” option is checked.

The following soft keys are available from the PARALLEL UNITS screen:

SOFT KEY	Description
Discover units (SK1)	Re-scan the system interface bus to determine how many units are on the bus. This also happens at power on.
Back (SK5)	Returns to the previous screen.

Table 6-22: Available PARALLEL UNITS screen soft keys

6.8.8 SCPI CONSOLE

The SCPI Console screen allows entry of remote control SCPI command directly from the front panel instead of one of the available remote-control interfaces. This feature is similar to the command line available at the bottom of the Web browser interface Home page.



The following softkeys are available to operate this feature:

Query / Write	Sends the SCPI command shown in the command line on top. The default command is the *IDN? Query which returns the make and mode of the power source. This field will also retain the last command entered by the user.
Clear	Clears the text in the command line and the response area below it.
Scroll Up/Down	Allows scrolling of the text in the response area.
Back	Returns to the System Menu page.

6.8.9 SYSTEM SETTINGS Screen

This screen allows system level settings such date and time to be changed. It also controls the UPC Compatibility mode setting.

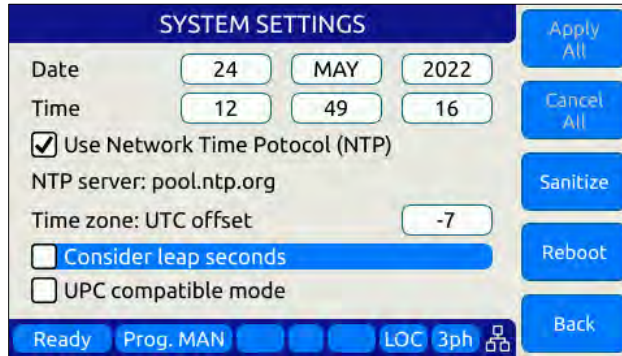

Figure 6-24: SYSTEM SETTINGS Screen

The following parameters can be set from this screen:

Date	Sets the date for the real-time clock.
Time	Sets the time for the real-time clock.
Use Network Time Protocol	When set, the time and date will be adjusted based on the NTP protocol. This requires the unit to be connected to a local area network.
Time zone UTC offset	This parameter sets the number of time zone from UTC where the unit is located to reflect local time. Coordinated Universal Time (UTC) is the primary time standard by which the world regulates clocks and time. It does not observe daylight saving time.
Consider Leap Seconds	When enabled, the time setting incorporated any lead seconds for the current year in the time setting.
UPC compatible mode	When enabled, the controller operates in UPC compatibility mode for back ward compatibility with legacy PPS UPC controllers.

The soft keys on the SYSTEM SETTINGS screen provide access to additional functionality as listed in the table below.

SOFT KEY	Description
Apply All (SK1)	Applies all changes made to this screen.
Cancel All (SK2)	Cancels any changes made and returns to previous screen
Sanitize	Erases all user settings from the unit and returns it to its factory default state.
Reboot	Reboot front panel controller without cycling AC input power.

SOFT KEY	Description
Back (SK5)	Returns to the previous screen.

Table 6-23: Available SYSTEM SETTINGS screen soft keys

6.8.10 MEMORY MANAGEMENT Screen

The ADF Series® is able to use a wide variety of external storage devices such as USB memory sticks and SD-Cards in addition to its internal storage memory. These devices may be used to store or load data, programs (setup + transient) etc.

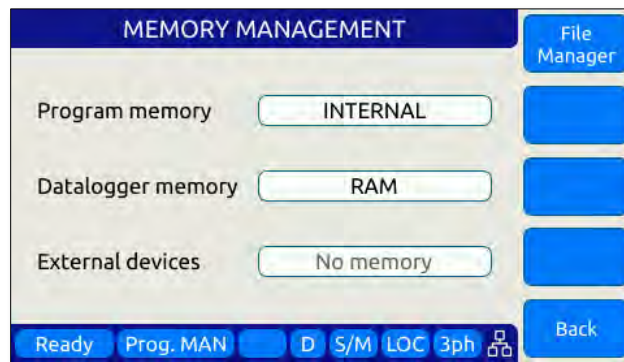

Figure 6-25: MEMORY MANAGMENT Screen

Program storage memory defaults to INTERNAL but can be changed to any available (inserted and mounted) external memory device if needed. The first parameter field is used to make this selection.

If any external memory devices are inserted, they will appear in the “External memories” field at the bottom of this screen.

Note: Maximum supported external memory device storage size is 32 GBytes.

The following files types can be located in each of these directories.

Subdirectory	File type and naming convention
plot	Measurement plots
sequences	Test sequences
screenshots	PNG image files captured from the LCD screen with filename convention screenshot_YYYY-MM-DD_HH-MM-SS.png where YYYY-MM-DD_HH-MM-SS is the time stamp.
waveforms	CSV comma separated waveform data files with filename convention X.csv where X is a number form 2 through 200.
program	Steady state + transient segment files using filename convention program_xx.xml where xx = 00 through 99 indicated program memory location #.

6.8.10.1 Loading Programs from a USB Drive.

Programs stored on a USB drive using the directory structure shown in the previous section can be loaded using the Browser interface – see section 10.7.4 on page **Error! Bookmark not defined.**– or from the front panel.

To load from the front panel USB ports, store the program_xx.xml file in the program subdirectory and insert in one of the two USB A ports on the front panel. After a short period of time, the drive will mount and will be visible in the CONF -> PROGRAM BROWSER screen.



Select the USBA1 drive in the upper right corner Memory field to see the available program files on the USB drive. Scroll down with the shuttle to select the desired program file to load.

Then use the **Recall** Softkey to load the selected program file. The program will now be available in the assigned program memory location as determined by the XML file name.



Note: program_xx.xml files must have a Steady State section to be valid. The Transient section may be empty in which case no transient will be loaded.

6.8.10.2 File Manger Operation

To access the File Manager functions, Press “**SYST**” -> **Memory management**” –(**Sk1**) **File Manager**”. The File Manager allows the user to browse through the directories and files stored on the selected memory type, INTERNAL, RAM or External media. Select the relevant memory type before entering this screen. See sample screens below.

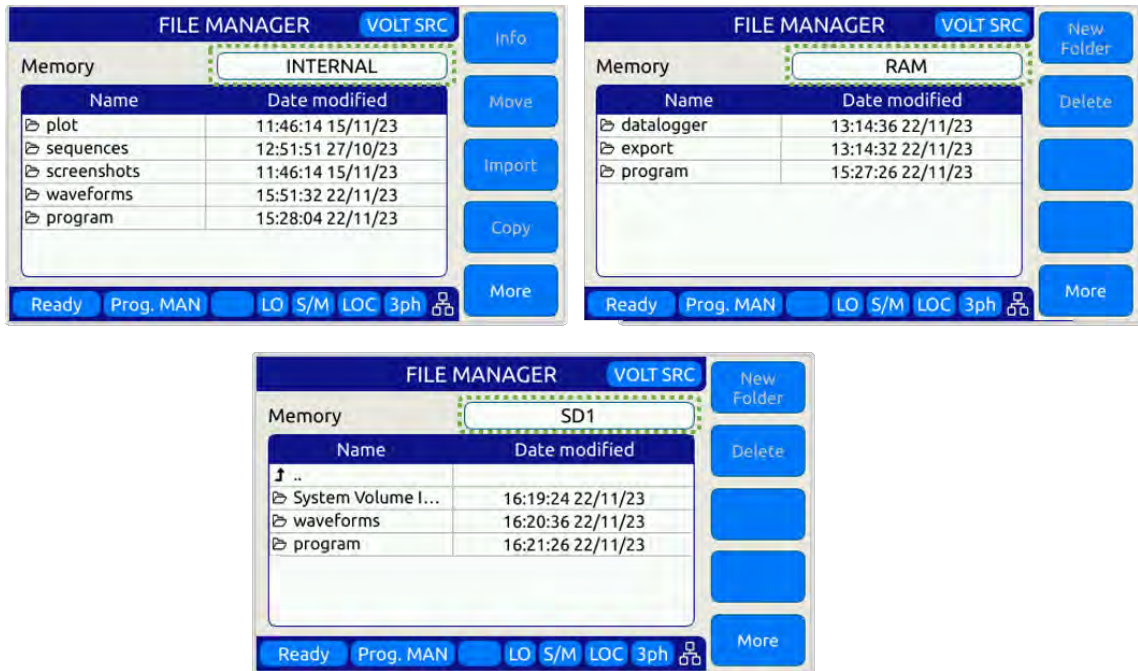

This screen contains file info such as date/time, and supports the following functions:

1. Move, Copy and Delete files.
2. Create new folders.
3. Import Waveforms.
4. Import Programs.

To navigate between files and folders, use the shuttle knob to select a folder and press to enter.

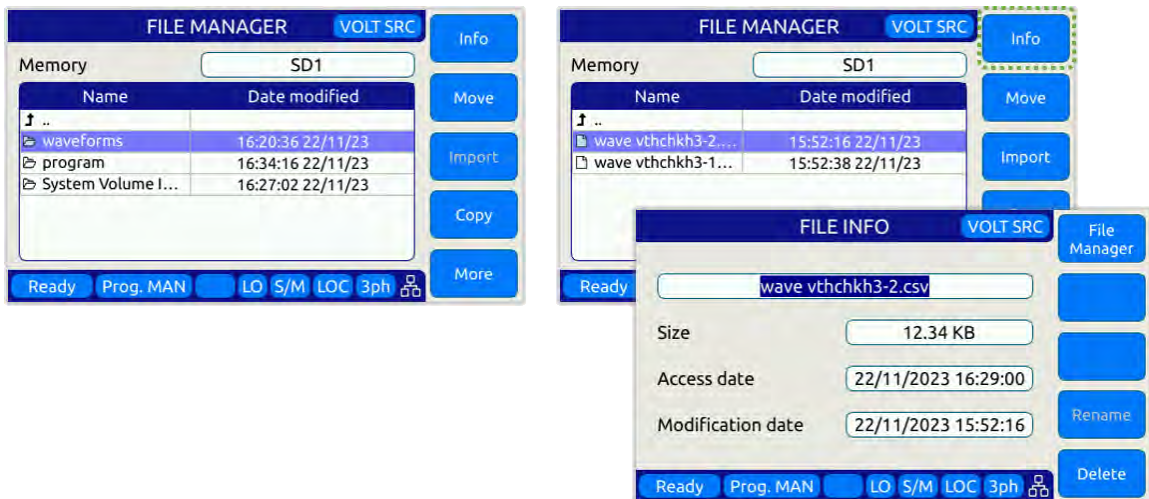

Importing Waveforms

The Import softkey allows importing of CSV format waveforms. Select the location to import the content of the waveform from. Use the +/- softkeys or the shuttle knob to scroll the waveform number. Press the Import (Sk1) softkey and YES to confirm when prompted.

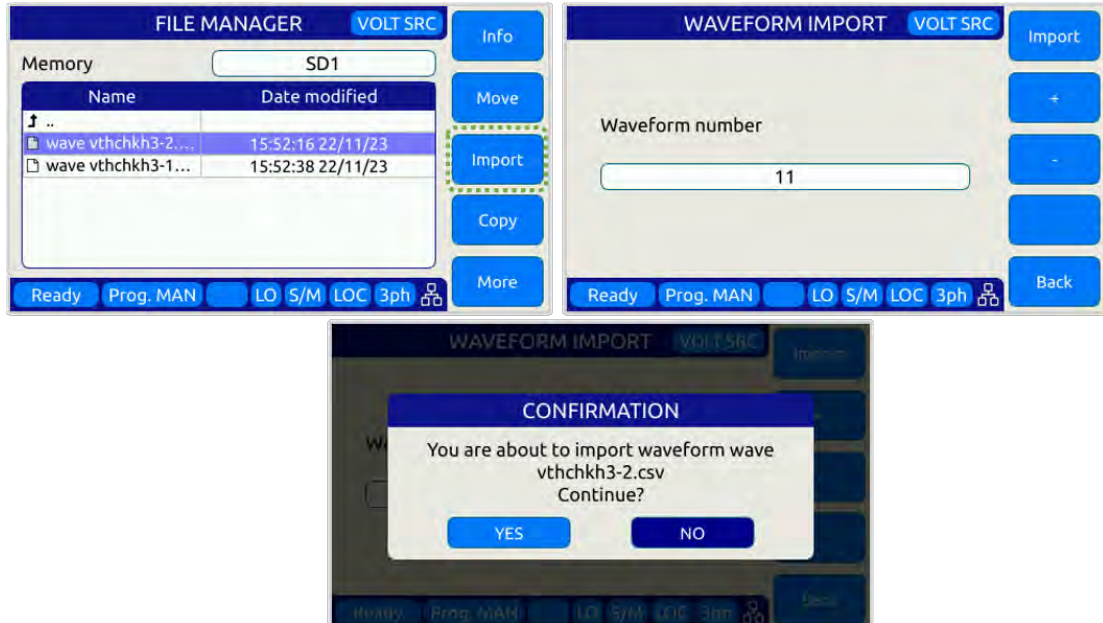

Importing Programs

Importing xml format program files uses a similar process except they are stored in a register location by number. Select the desired program file, select the memory type and register number and press Import (Sk1), the confirm when prompted.

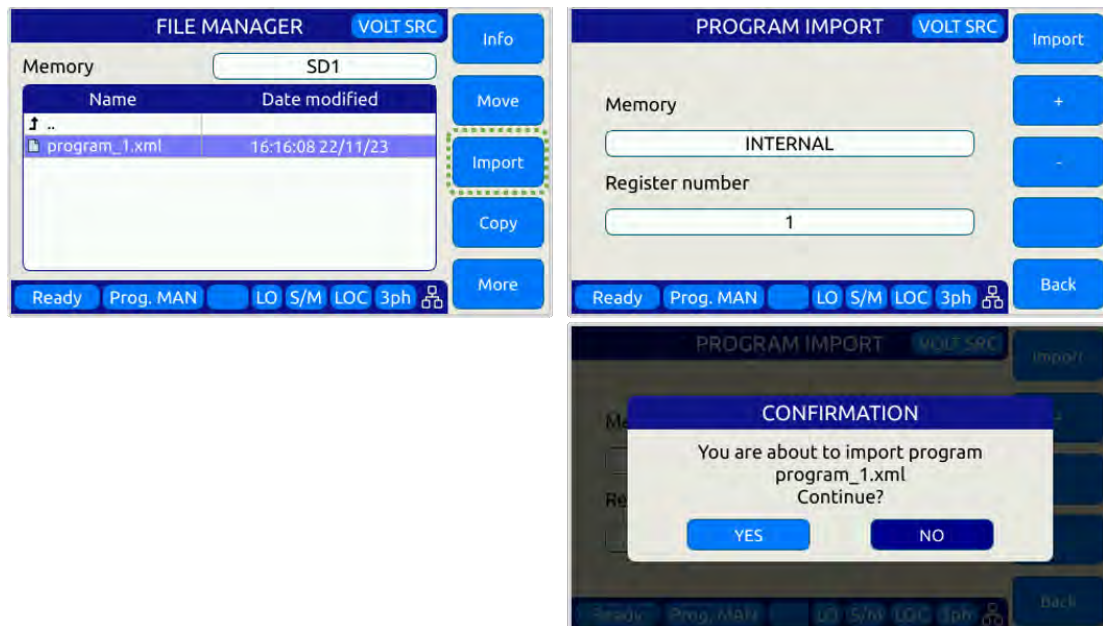

Moving Files

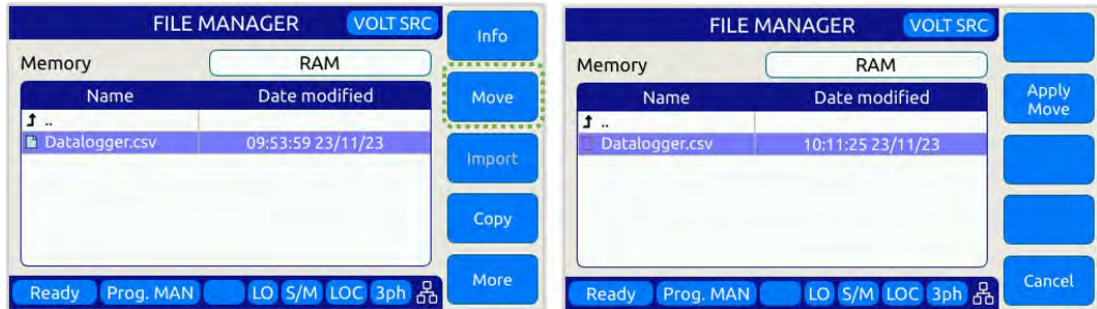

- Changes the directory and then press “Apply Move”

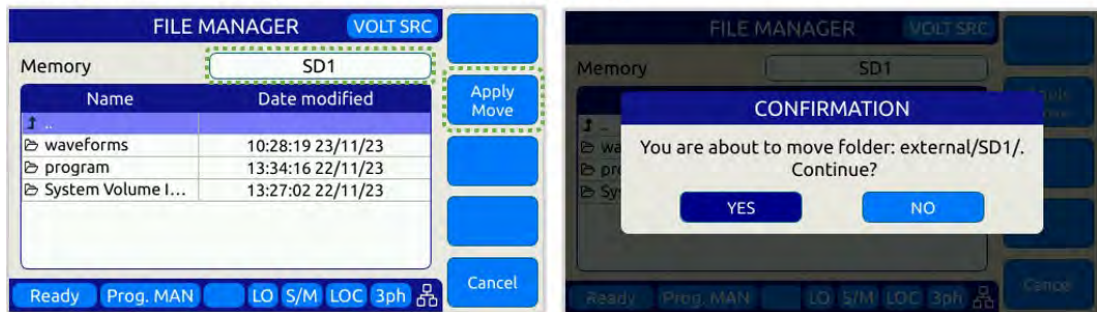

Copy and Pasting Files

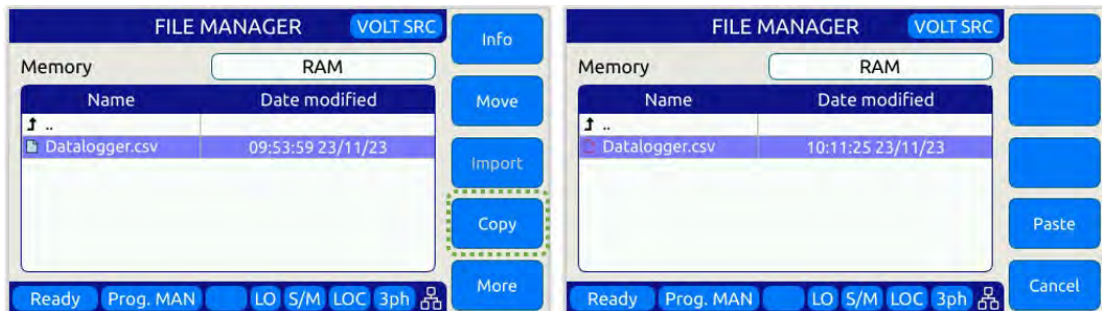

Changes the directory (and/or Memory) and then press “Paste”

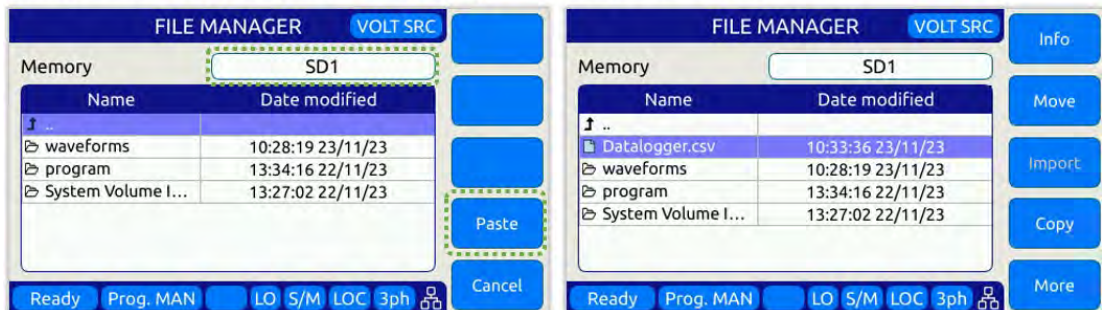

Deleting Files

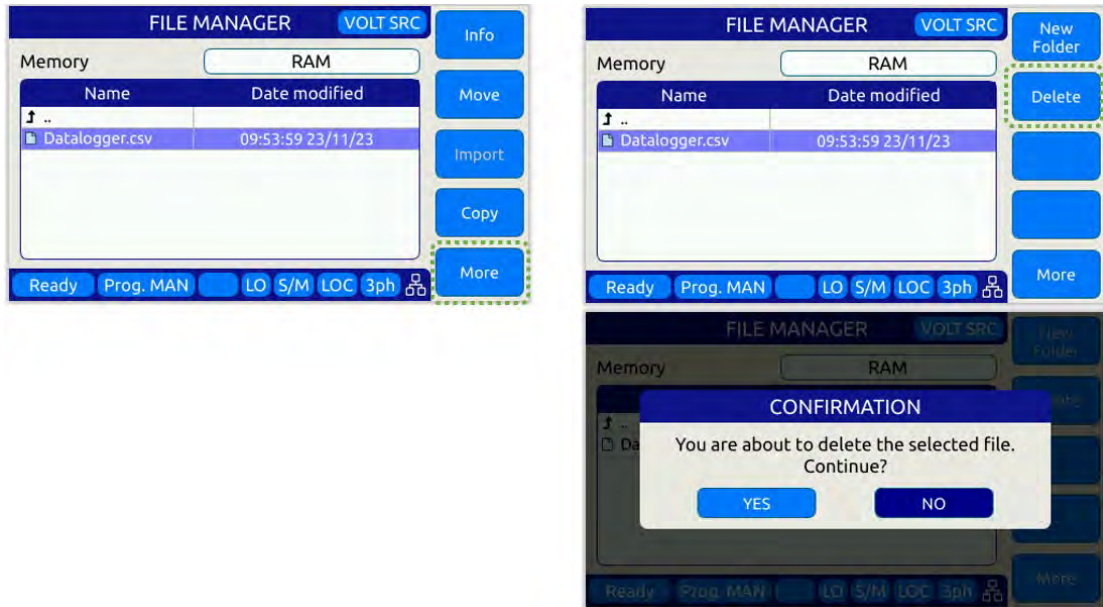

6.8.11 CALIBRATION MENU Screen

All power sources are shipped with a Certificate of Compliance to NIST traceable standards (“CoC”) from the factory. Output and Measurements are calibrated to an external reference DMM at the same time. A suitable current shunt or current transformer and a load will be required to perform calibration.

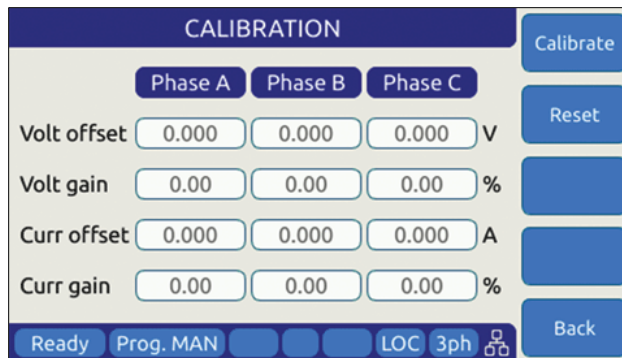

Figure 6-26: CALIBRATION MENU Screen

The following soft keys are available from the CALIBRATION MENU:

SOFT KEY	Description
Calibrate (SK1)	Enters calibration state
Reset (SK2)	Resets all calibration coefficients' previous values.
-	
-	

SOFT KEY	Description
Back (SK5)	Returns to previous screen

Table 6-24: Available CALIBRATION MENU screen soft keys

For details on calibration requirements and procedures, refer to the Calibration section towards the end of this manual. (Section 11, “Calibration”).

6.8.12 FIRMWARE UPDATE Screen

Firmware updates may be distributed via different media such as SD-Card, USB memory stick or on-line through Pacific’s FTP site. The FIRMWARE UPDATE screen provides the means for the end user to perform a firmware update.

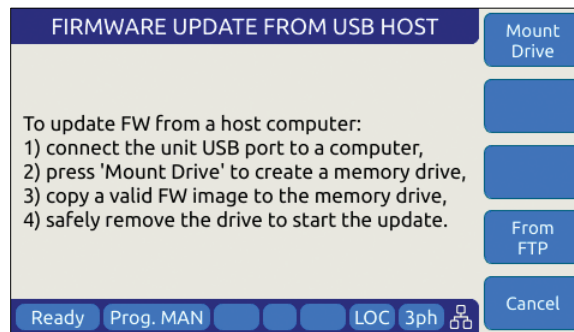

Figure 6-27: FIRMWARE UPDATE Screen

The following soft keys are available from the FIRMWARE UPDATE screen:

SOFT KEY	Description
Mount Drive (SK1)	Mount media that contains new firmware revision.
-	-
-	-
From FTP (SK4)	Install latest firmware from Pacific Power Sources’ FTP server.
Cancel (SK5)	Exit firmware update screen

Table 6-25: Available FIRMWARE UPDATE screen soft keys

6.8.13 REMOTE SUPPORT Screen

The REMOTE SUPPORT feature can be used to send information to customer support in case the user experiences an issue with the unit. It also provides a means to allow Pacific’s technical support team to access the unit remotely assuming it is connected to a network with Internet access.

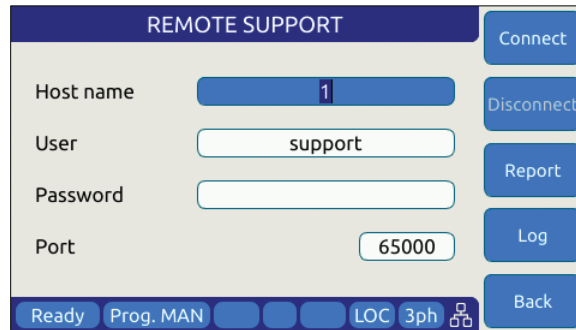

Figure 6-28: REMOTE SUPPORT Screen

The Report soft keys will cause a detailed report to be generated and sent to Pacific Power Source customer support so we can assist in resolving any technical support issues.

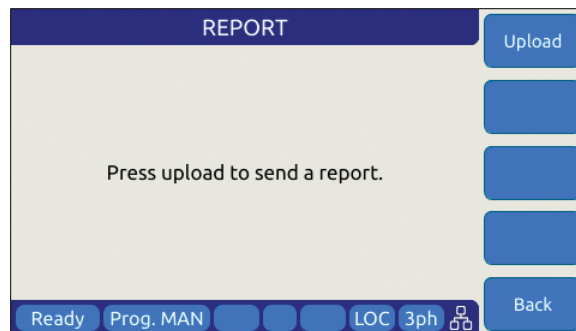

Figure 6-29: Remote Support REPORT Screen

The following soft keys are available from the LOGGING TOOL screen:

SOFT KEY	Description
Connect (SK1)	Connect to Pacific Power Support site
Disconnect (SK2)	Disconnect from Pacific Power Support site
Report (SK3)	Generates a report for Customer Support Department
Log (SK4)	Start Logging
Back (SK5)	Returns to the previous screen.

Table 6-26: Available LOGGING TOOL screen soft keys

7 Rear Panel, Connectors and Protection

This section describes the rear panel layout of the ADF Series® AC power source.

7.1 OUTPUT Terminals



WARNING

HAZARDOUS OUTPUT: The power source output may be set to hazardous voltage levels. It provides basic isolation from the AC input mains. Therefore, the output must always be considered hazardous. Connections must be inaccessible to the operator in all situations when AC input mains voltage is applied.

Always disconnect power supply from the mains before connecting or disconnecting to the hazardous output terminals.



AVERTISSEMENT

SORTIE DANGEREUSE: La sortie de l'appareil peut être réglée à des niveaux de tension dangereux. L'appareil fournit une isolation de base du réseau d'entrée AC. Par conséquent, la sortie doit toujours être considérée comme dangereuse. Les connexions doivent être inaccessibles à l'opérateur dans toutes les situations où la tension d'entrée secteur est appliquée.

Toujours débrancher l'alimentation secteur avant de connecter ou déconnecter les bornes de sortie dangereuses.

The output terminal block for load connections is located near the center of the rear panel.

Note: Always refer to Section 2.3 “Safety Information” before making any load connections.

7.1.1 Output Power Connector Rating and Isolation

Maximum rated output voltage:	300V rms AC, 425Vdc
Maximum Current Rating:	60A
Connector Type:	Phoenix Contact SPC 16/ 6-STF-10, 16 - 1711417
Designated Use:	AC Load Connection
Isolation Rating:	600V
Wire Stripping Length:	18 mm
Nominal Contact Cross Section	16 mm ²

7.1.2 Wire Size

A major consideration in making load connections is the wire size. The minimum wire size is required to prevent overheating and to maintain good regulation. It is recommended that the wires are sized large enough to limit the voltage drop at the maximum current rating of the AC power source to less than 0.5V per lead.

Wire size also depends on ambient temperature and total wires in the cable bundle. For example, for the full 41.7 amp current capability of a single output, at an ambient temperature of 30 °C, in a bundle of not more than three 75 °C rated wires, common electrical codes would recommend AWG 8 size (~10 mm²). However, maximum supported Wire Size for the output connector is AWG 6.

AWG	Diameter		Turns of wire, without insulation		Area	
	(in)	(mm)	(per in)	(per cm)	(kcmil)	(mm ²)
6	0.1620	4.115	6.17	2.43	26.3	13.3

7.1.3 Connecting a UUT

When setting up for a new test and connecting any equipment to the AC power source, proceed as follows:

1. Always make sure the AC power source is turned OFF at the POWER switch when making any wire connections.
2. Check that the output of the equipment under test is **OFF**.
Note: Some power equipment's output may still be energized even if the equipment has been turned off or its output is turned off. This is especially true for AC power sources.

Note: When working with batteries, it is recommended to provide a suitable disconnect relay or switch so the AC power source can be physically disconnected from the battery for handling purposes.

3. Connect one end of the load wires to the output terminals on the rear panel.
4. Check the polarity of the connections and connect the other end of the load wires to the input terminals of the equipment under test.

7.2 External Voltage Sense Input Terminals



WARNING

HAZARDOUS OUTPUT: The power source output may be set to hazardous voltage levels. It provides basic isolation from the ac input mains. Therefore, the external voltage sense must also always be considered hazardous. Connections must be inaccessible to operator in all situations when ac input mains voltage is applied.

Always disconnect power supply from the mains before connecting or disconnecting to the hazardous external voltage sense terminals.



AVERTISSEMENT

SORTIE DANGEREUSE: La sortie de l'appareil peut être réglée à des niveaux de tension dangereux. L'appareil fournit une isolation de base du réseau d'entrée AC. Par conséquent, la sortie doit toujours être considérée comme dangereuse. Les connexions doivent être inaccessibles à l'opérateur dans toutes les situations où la tension d'entrée secteur est appliquée.

Toujours débrancher l'alimentation secteur avant de connecter ou déconnecter les bornes de sortie dangereuses.

This section covers external voltage sensing. This feature improves voltage accuracy at the point of load when used correctly.

Note: External Voltage sense is sometimes referred to as Remote Voltage sense and Internal Voltage sense is sometimes referred to as Local Voltage sense. Both definitions are used in the industry. For consistency, External Voltage Sense and Internal Voltage Sense are used in this manual.

7.2.1 External Voltage Sense Connector Rating and Isolation

Maximum rated voltage:	400V rms AC, 425Vdc
Maximum Current Rating:	1A
Connector Type:	ADF A Version: Phoenix Contact P/N SPT 5 / 6-H-7,5-ZB - 1719231
Designated Use:	AC Load Connection
Isolation Rating:	600V
Wire Stripping Length:	10 mm

7.2.2 Load Connection without External Voltage Sense

ADF Series® power sources can be operated with internal voltage sense. For higher current loads, the voltage at the load will drop due to the load cable impedance. Using the proper wire gauge for the rated current of the AC source is required to minimize load cable impedance.

7.2.3 Load Connection with External Voltage Sense.

The following points must be considered, when existing sense cables are connected directly to the load or to the central load distribution point:

1. Minimize the distance between the AC power source and the load as much as possible to keep load wire length to a minimum.
2. Directly connect **A, B, C** and **N** with **correct phasing** to the load distribution point
3. Twist each phase sense wire with a neutral sense wire to minimize cross talk. Three neutral connection points are provided for this purpose.

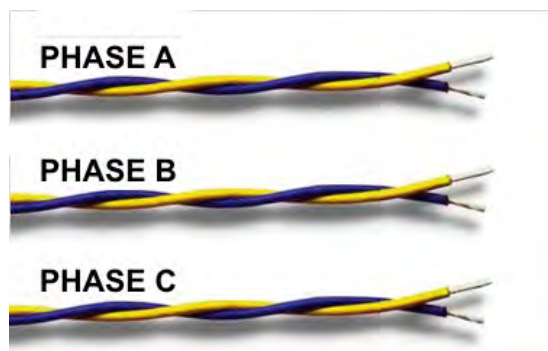

4. Avoid overload of power wires

Note: External voltage sense connections are at the programmed output voltage when the output is on so DO NOT connect or disconnect the external voltage sense lines while the AC power source is in use.

ADF L Version units are shipped with the mating sense connector installed but no wires to prevent contact with the sense connections. ADF A Version units don't require a mating connector.

7.3 Auxiliary I/O

The Auxiliary I/O functions are available on all ADF Series power source models.

7.3.1 Auxiliary I/O Functions

The Auxiliary I/O board when added to an ADF Series power source adds the following functions and features:

- Digital Inputs for trigger functions and control.
- Digital Outputs for status indication and relay control.
- Analog Inputs for control of power source parameters.
- Analog Outputs for measurement monitoring.
- A 12Vdc power output to power external circuits.
- RS232 Serial Interface.
- Optional embedded GPIB Control Interface

The analog, digital and RS232 ports are accessible on a female DB25 connector located on the rear panel of the ADF master unit. This connector is mounted upside down so pin 1 is located in the lower right-hand corner when facing the back of the ADF master unit.

The USB, LAN and optional GPIB connectors are located to the left of the AUX I/O connector on the rear panel when facing the power source from behind.



Figure 7-1: Rear Panel AUX I/O DB25 Connector Location

7.3.2 DB25 Connector AUX I/O Pin locations

The pin locations for the various I/O signals on the DB25 connectors are shown in Figure 7-2 below. Note that the connector is installed “Upside” down due to mounting constraints.

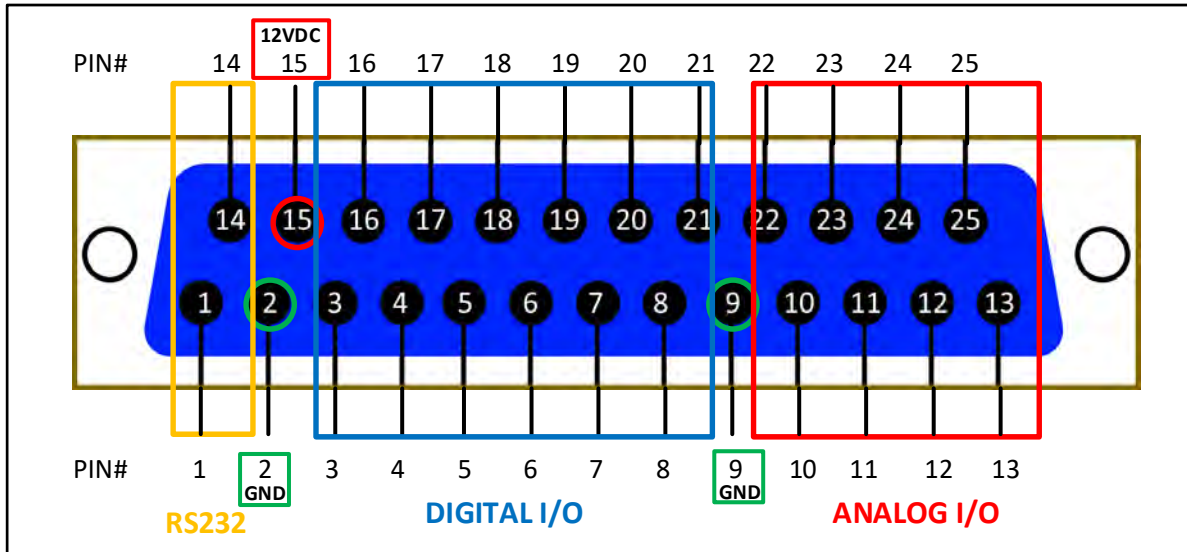

Figure 7-2: DB25 Connector AUX I/O Pin Locations

Functional grouping of pins by I/O function is done as shown in the figure above. The left hand side groups all **Analog I/O** signals on top on bottom row. The middle section is reserved for all **Digital I/O** pins. The **RS232** Transmit (Tx) and Receive (Rx) signals are located on the far right.

7.3.3 I/O Signal Table by pin number

Pin assignments in order of pin number are shown in the table below.

Pin #	Name	Primary Function	Alternate Use / Comment	Type	Direction
1	RxD	RS232 Receive Data (Rx)		RS232	Input
2	GND	Chassis Ground		Ground	n/a
3	DI1	General Purpose Digital Input #1	Programmable	Digital	Input
4	DI2	General Purpose Digital Input #2	Programmable	Digital	Input
5	DI3	General Purpose Digital Input #3	Programmable	Digital	Input
6	RI	Remote Inhibit	Short to +12Vdc Pin 15	Digital	Input
7	TT	Transient Trigger Input		Digital	Input
8	Sync In	Phase Sync Input		Digital	Input
9	GND	Chassis Ground		Ground	n/a
10	AI1	Analog Input – Volt RMS Phase A	Any set point	Analog	Input
11	AI2	Analog Input – Volt RMS Phase B	Any set point	Analog	Input
12	AI3	Analog Input – Volt RMS Phase C	Any set point	Analog	Input
13	AI4	Analog Input – Current Limit RMS all phases	Any set point	Analog	Input
14	TxD	RS232 Transmit Data (Tx)		RS232	Output
15	12V	Output, 12Vdc	0.5 A max, current protected	Power	Output
16	DO3 /RC1	Relay Control #1 – FORM	Programmable, Open Collector, Current protected	Digital	Output
17	DO4 /RC2	Relay Control #2 - TRANSFORMER	Programmable, Open Collector, Current protected	Digital	Output
18	FS	Trigger Output / Function Strobe		Digital	Output
19	Sync Out	Phase Sync Output		Digital	Output
20	DO1	General Purpose Digital Output #1	Programmable	Digital	Output
21	DO2	General Purpose Digital Output #2	Programmable	Digital	Output
22	AO1	Analog output #1 – Volt RMS Measurements Phase A	Any other measurement	Analog	Output
23	AO2	Analog output #2 – Volt RMS Measurements Phase B	Any other measurement	Analog	Output
24	AO3	Analog output #3 – Volt RMS Measurements Phase C	Any other measurement	Analog	Output
25	AO4	Analog output #4 – Total Power (all phases combined)	Any other measurement	Analog	Output

Table 7-1: Auxiliary I/O DB25 Connector Pin numbers and Signals by DB25 pin number

7.3.4 I/O Signal Table by Function

Pin assignments in order of pin number are shown in the table below.

Pin #	Name	Primary Function	Alternate Use / Comment	Type	Direction
10	AI1	Analog Input – Volt RMS Phase A	Any set point	Analog	Input
11	AI2	Analog Input – Volt RMS Phase B	Any set point	Analog	Input
12	AI3	Analog Input – Volt RMS Phase C	Any set point	Analog	Input
13	AI4	Analog Input – Current Limit RMS all phases	Any set point	Analog	Input
22	AO1	Analog output #1 – Volt RMS Measurements Phase A	Any other measurement	Analog	Output
23	AO2	Analog output #2 – Volt RMS Measurements Phase B	Any other measurement	Analog	Output
24	AO3	Analog output #3 – Volt RMS Measurements Phase C	Any other measurement	Analog	Output
25	AO4	Analog output #4 – Total Power (all phases combined)	Any other measurement	Analog	Output
3	DI1	General Purpose Digital Input #1	Programmable	Digital	Input
4	DI2	General Purpose Digital Input #2	Programmable	Digital	Input
5	DI3	General Purpose Digital Input #3	Programmable	Digital	Input
20	DO1	General Purpose Digital Output #1	Programmable	Digital	Output
21	DO2	General Purpose Digital Output #2	Programmable	Digital	Output
18	FS	Trigger Output / Function Strobe		Digital	Output
16	DO3 /RC1	Relay Control #1 – FORM	Programmable, Open Collector, Current protected	Digital	Output
17	DO4 /RC2	Relay Control #2 - TRANSFORMER	Programmable, Open Collector, Current protected	Digital	Output
6	RI	Remote Inhibit	Short to +12Vdc Pin 15	Digital	Input
8	Sync In	Phase Sync Input		Digital	Input
19	Sync Out	Phase Sync Output		Digital	Output
7	TT	Transient Trigger Input		Digital	Input
15	12V	Output, 12Vdc	0.5 A max, current protected	Power	Output
2	GND	Chassis Ground		Ground	n/a
9	GND	Chassis Ground		Ground	n/a
1	RxD	RS232 Receive Data (Rx)		RS232	Input
14	TxD	RS232 Transmit Data (Tx)		RS232	Output

Table 7-2: Auxiliary I/O DB25 Connector Pin numbers and Signals by Signal Name

7.3.5 Dedicated Function Digital Inputs

- Remote Inhibit
- External Trigger Input
- External Phase Sync Input

7.3.5.1 Remote Inhibit

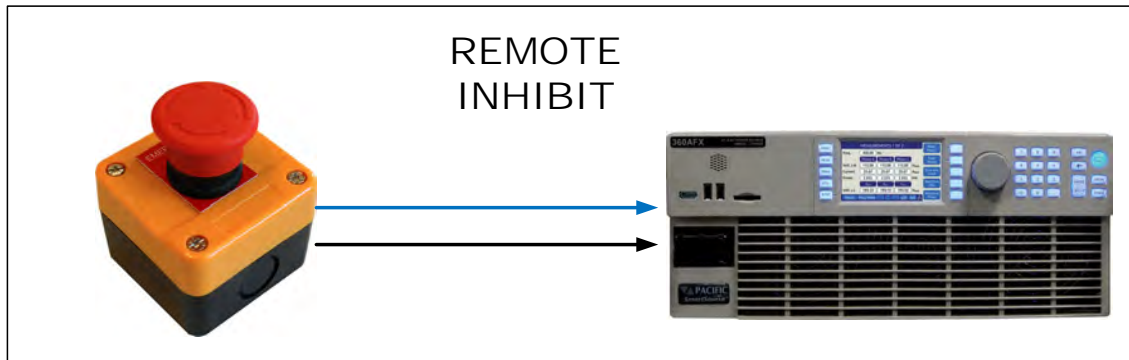

The mode can be selected from the SYST (SYSTEM) menu screen using the Interfaces, Remote Inhibit selection as shown below.

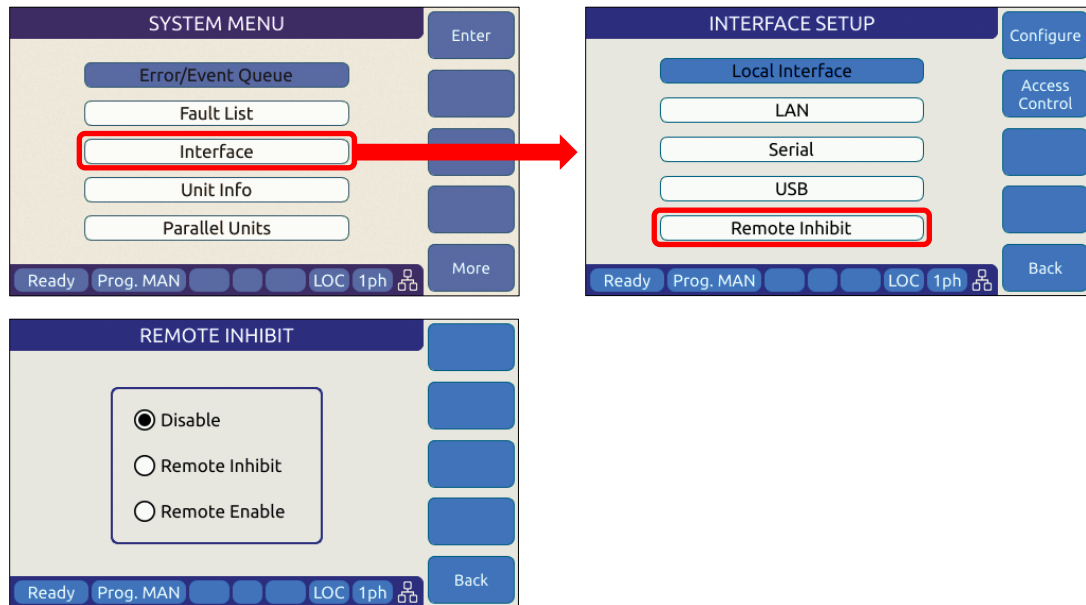

There are three modes of operation for this input:

1. **Disable mode:** In this mode, the Remote Inhibit inputs are not active so this function is turned off. No short between the RI pins is required to enable the output in this mode.

2. **Remote Inhibit mode:** The Remote Input pins 6 and 15 on the rear panel DB25 AUX I/O have to be shorted for the output to be enabled from the front panel or remote command. This is a necessary but not a sufficient condition to enable the output. If the output is enabled and the remote inhibit connection is open, a fault is generated. This mode is recommended for interlock safety applications such as safety cages and test fixture interlocks.

Command: SYSTem:DIO:REMOte:INHibit 0 | 1

3. **Remote Enable mode:** The output can be enabled by shorting pins 6 & 15 on the rear panel DB25 AUX I/O connector, regardless of the output enable command/button. It is a sufficient condition to enable the output.

Command: SYSTem:DIO:REMOte:ENABle 0 | 1

This function can be enabled or disabled at power on using

Command⁴: SYSTem:DIO:REMOte:ENABle:AUTO 0 | 1 (default = 1)

When AUTO is set to 1, output is enabled immediately after power up if the remote enable input is 1. When Auto is set to 0, output is enabled only when a 0 to 1 input level change is detected and disabled on a 1 to 0 level change.

Both settings can be changed by the user. Sending a sanitize command returns both back to 1 and 0 respectively.

Countdown beeping warning before enabling output, like a time boom. The warning pop-ups messages below are shown on LCD and webpage before enabling the output.

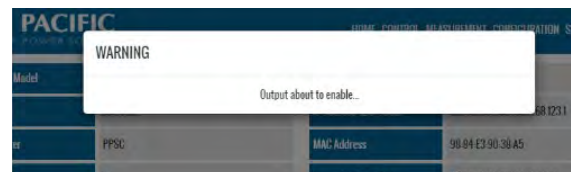
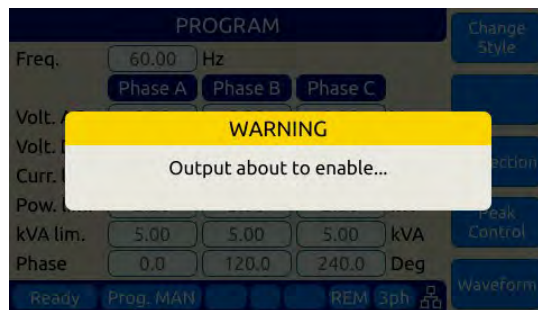

4. Transient Trigger Input

⁴ This command is supported with firmware revision 2.2.48 or higher only.

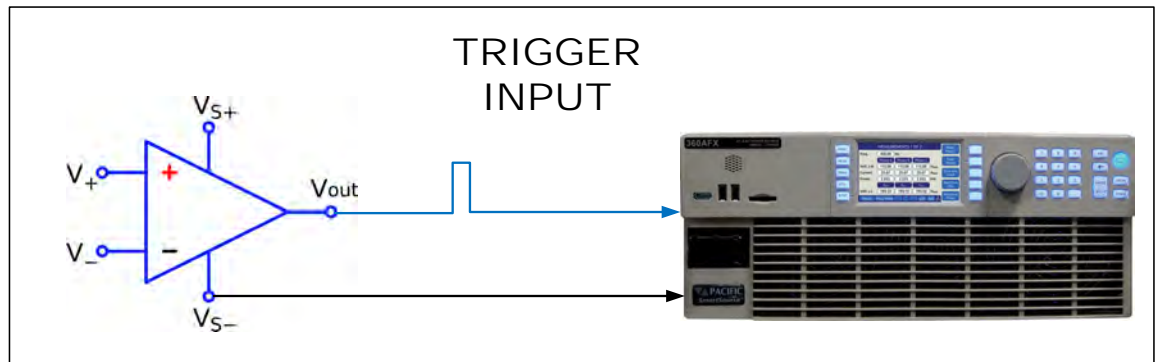

The external trigger input can be programmed to trigger the start of a transient program. This allows the power source output sequence to be initialized by an external sync signal.

In order to use the trigger input, the mode has to be active (from any of the graphical interfaces or using the SCPI command PROGRAM:TRANSient:TRIGger:INput), and the transient program has to be executed first. The transient will wait and start execution when a rising edge is detected on this digital input.

The graphical interfaces (front panel and webpage) will show the state “Running” but with a progress of 0% until the transient program is actually started.

The following specifications apply to the external trigger input:

Input Voltage	Logic Low $V_{in} < 0.4 \text{ V}$ Logic High $V_{in} > 2.0 \text{ V}$
Impedance	10 k Ω
Edge Triggered	Rising edge

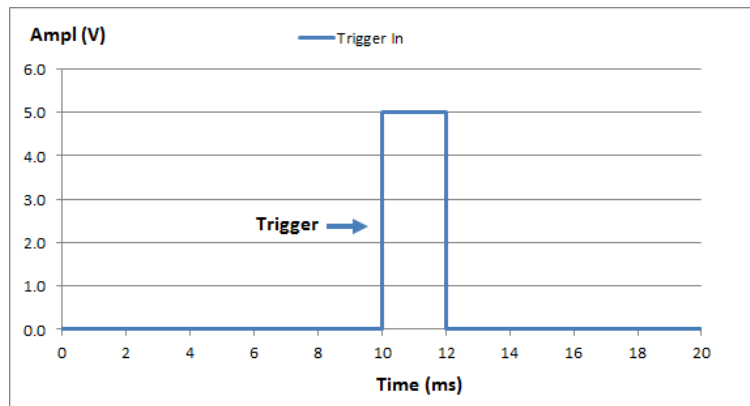
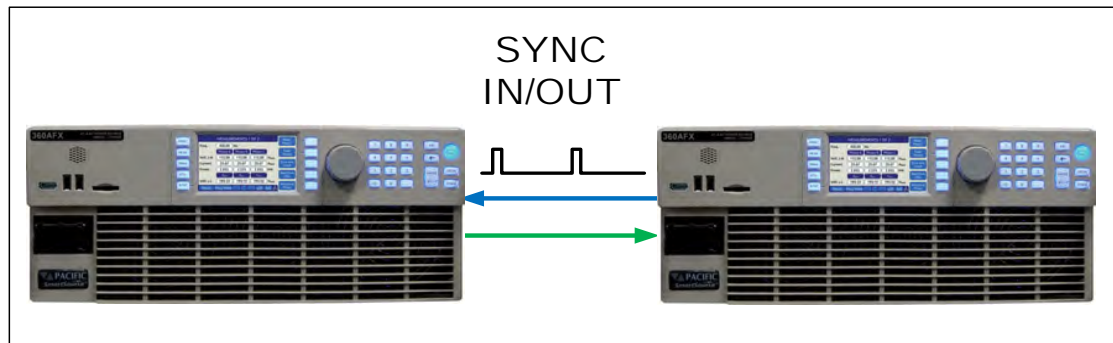

Figure 7-3: External Trigger Input Timing

7.3.6 External or Line Sync Input



The phase sync input can be used to synchronize in frequency and phase the internal waveform generation of the ADF to an external sync reference or to the AC mains. The reference must be within the specified frequency range of the power source and zero phase offset calibration for phase A may be required to compensate for any phase shifts. Note that Phase B and C are still phase related to A as programmed by B and C phase angles.

7.3.6.1 Principle of Operation

In AC Line sync mode, the ADF uses the L-L AC input voltage to generate the internal sync signal. The goal of the phase sync is to provide precise frequency synchronization, and consistent phase at a given operating point, but the phase shift between AC input and AC output is not automatically zero. A phase adjustment for Phase A must be made by the user to time-align the power source's phase A output voltage to the L1 leg of the actual three phase Grid voltage powering the ADF.

A couple of factors affect the phase shift:

- The internal AC sync circuits have some inherent delays. If more accuracy is required then the TTL input mode can be used instead using an external line sync circuit.
- Even if TTL input is used, there can be a phase shift that depends on the output load because of the finite bandwidth of the output inverter stages. This is particularly visible at higher frequencies. At 50Hz or 60Hz, the phase shift will be pretty small.

Note: When the sync input is enabled, the ADF frequency set point **must** be set to a value similar to the external sync signal. This minimizes the synchronization time and improves the stability of the generated frequency.

After the sync input is activated, or the external signal frequency/phase is changed, the Sync circuit's Phase Lock Loop (PLL) requires a short time to "lock" to the external source. The ADF reports the status of the PLL in the external interfaces (front panel and webpage) by showing a "Synced" or "Unsynced" message in the status bars. (See section 0 for details).

The status can also be queried with the SCPI command "SOURCE:SYNChronize:STATe?".

The sync circuit is able to synchronize to any signal with a frequency if $F_{\text{SETPOINT}} \pm F_{\text{RANGE}}$, where F_{SETPOINT} is the normal frequency set point and F_{RANGE} is a configurable value (default is 10Hz)

The following specifications apply to the phase sync input at the DB25 port:

Input Voltage	Logic Low $V_{in} < 0.4 \text{ V}$ Logic High $V_{in} > 2.0 \text{ V}$
Impedance	10 k Ω
Frequency Range	15 Hz – 1200 Hz
Edge Triggered	Rising edge

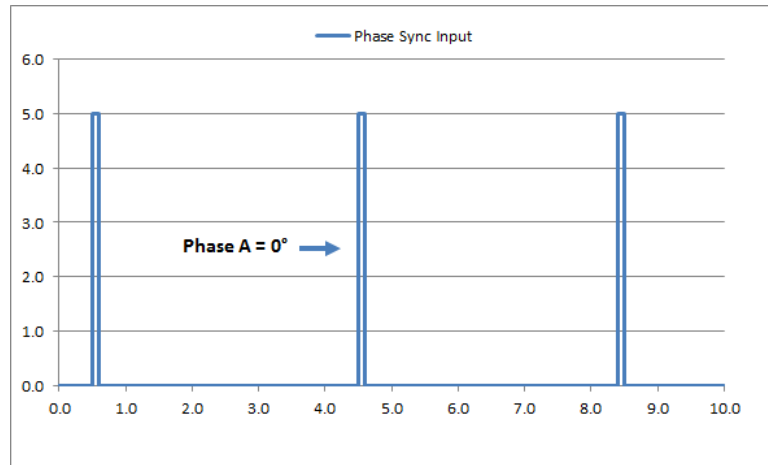

Figure 7-4: External Sync Input Pulses

7.3.6.2 SYNC Status Display

A “Synced” status field will be displayed in **Green** in the lower left corner of the LCD display. This field will toggle with the regular “Ready/Enabled/Fault” status field also shown in this location. The “Synced” status will be shown every 3 seconds for 1 second in place of the “Ready/Enabled/Fault” field. When the PLL is not locked to the external source, the unit will display an “Unsynced” status in **Orange**.

It is not recommended to enable the unit when it has not locked or synchronized to the external source because the frequency may be unknown.

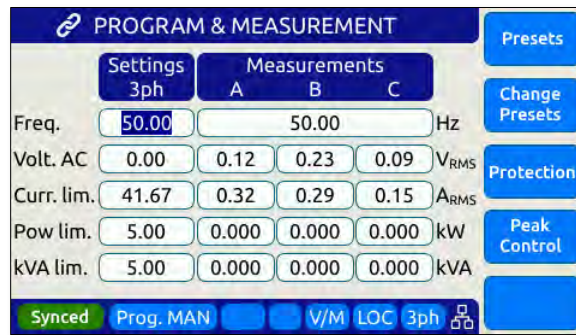

Figure 7-5: External Sync Input Sync Status Indication

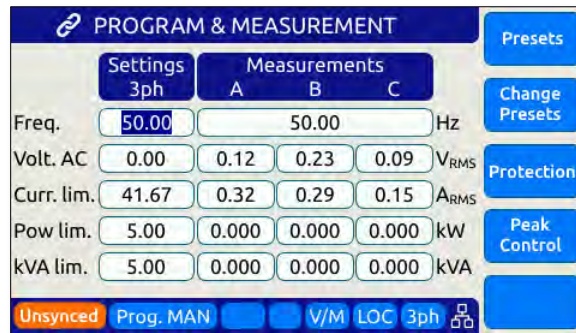

Figure 7-6: External Sync Input Sync Lost Status Indication

7.3.6.3 Sync Operation Settings

The ADF allows precise configuration of the synchronization parameters to optimize performance for each application. The parameters are:

- 1 **Phase shift:** Defines a fixed phase shift between phase A waveform generation and the external sync source. Used to calibrate any phase difference between the sync signal and the power source output on phase A.
Command: SOURce:SYNChronize:PHASEshift
- 2 **Speed:** Allows accelerating the speed of the internal synchronization engine (PLL) in case the external sync source is not constant and presents periodic or continuous changes. A slower speed improves the stability of the waveform frequency, so it is

recommended to use the smallest possible speed values.

Command: SOURce:SYNChronize:SPeEd

- 3 **Range:** Allows configuration of how much the synchronization engine is able to deviate from the ADF programmed frequency. This helps to keep the waveform frequency under control, even if the external source is not present all the time. The synchronization engine is limited to frequencies of FSETPOINT +/- FRANGE.

Command: SOURce:SYNChronize:RANGe

7.3.7 Digital Output control signals

- External Relay Control #1 - FORM
- External Relay Control #2 - TRANSFORMER
- Trigger Output / Function Strobe
- Phase Sync Output

7.3.7.1 Function Strobe / Trigger Out

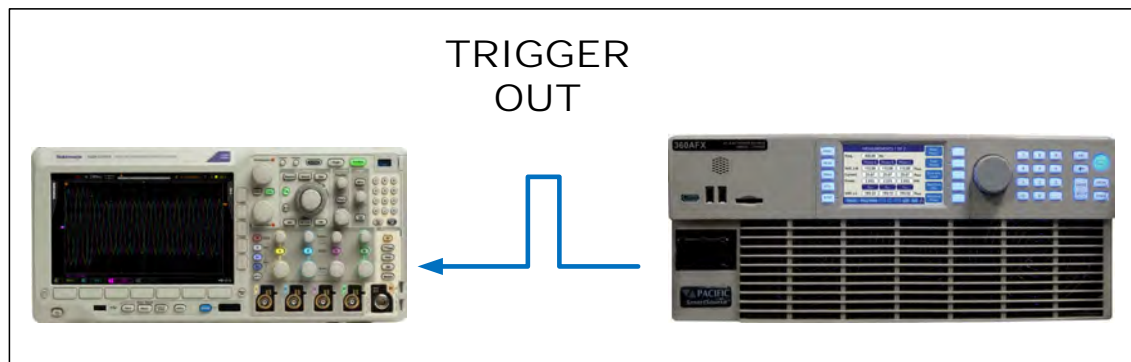

The external trigger output can be programmed to generate an output pulse on the following events:

- a. The start of a transient program (Transient Trigger)
- b. Output Replay State Change
- c. Any parameter change. Parameter changes that generate an output function strobe pulse are:
 - i. Voltage on any phase
 - ii. Frequency
 - iii. Waveform on any phase
 - iv. Phase angle

The mode can be set from the front panel or by using the following SCPI commands:

7.3.7.2 Phase Sync Output

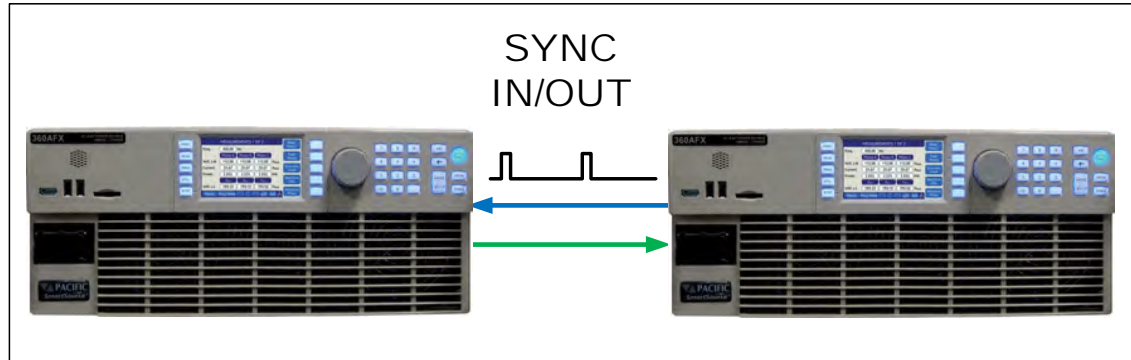

The phase sync output signal can be programmed to generate an output pulse at each zero crossing of the phase A voltage. This indicates the 0° phase angle output on Phase A.

The mode can be set from the front panel or by using the following SCPI commands:

The following specifications apply to the external trigger output:

Output Voltage @ 0.4 mA	Logic Low Vout < 0.4 V
	Log High Vout > 4.6 V
Max. Current	± 10 mA
Output Impedance	100 Ω
Pulse Width	100 us ± 10 us

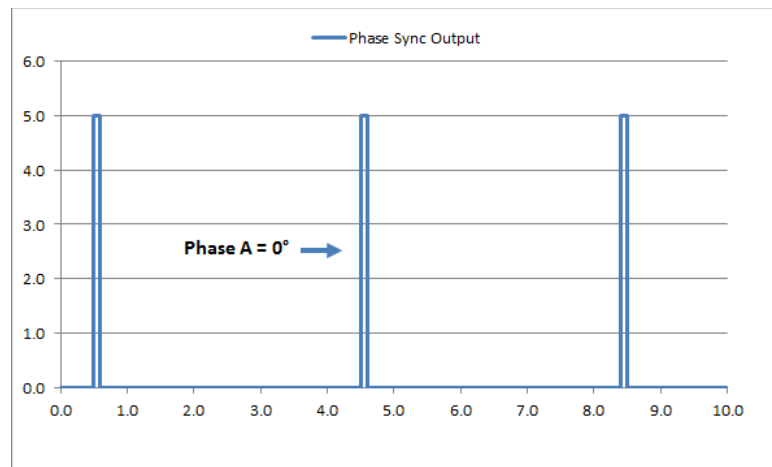
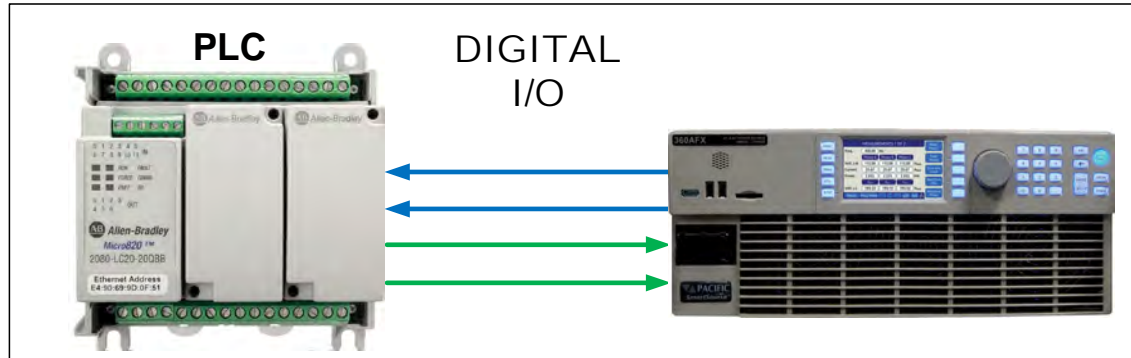

Figure 7-9: Phase A Zero Phase Sync Output Pulse

7.3.8 User Programmable Digital signals

Available user defined digital input and outputs are provided as part of the I/O feature. These signals may be assigned different purposes under software control.



User Programmable Digital Input signals functions are:

- DIO:INput1 - Digital Input #1
- DIO:INput2 - Digital Input #2
- DIO:INput3 - Digital Input #3

User Programmable Digital Output control signals are:

- DIO:OUTput1 - Digital Output – TTL level
- DIO:OUTput2 - Digital Output – TTL level
- DIO:OUTput3 - Digital Output – Open drain
- DIO:OUTput4 - Digital Output – Open drain

Digital outputs 3 and 4 are open drain with internal +5Vdc pull-ups.

7.3.8.1 Relay Control Outputs

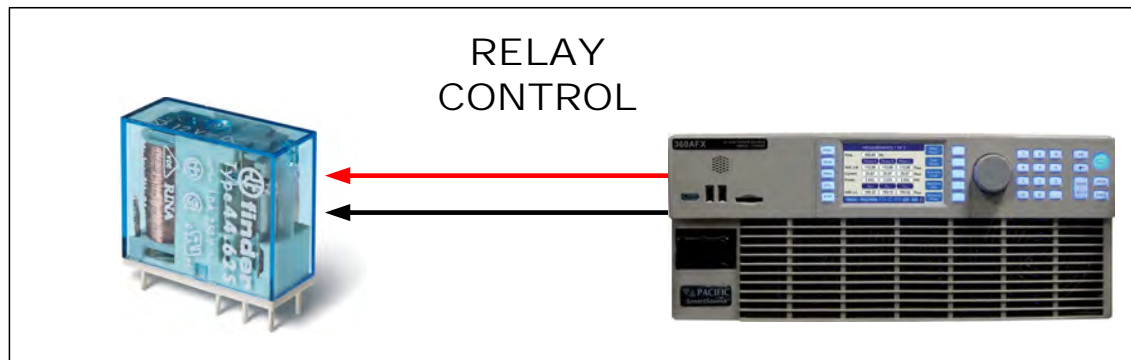

The external relay control output signals DO3 and DO4 can be used to control external relays. These control lines are user programmable for difference functions such as FORM relay control and Transformer Option control.

These relays are used to either short all outputs together for single-phase output mode or to connect and disconnect and external transformer for a higher voltage AC output range.

- Relay signal #3 is normally used for the FORM (Mode Change) Relay option on ADF cabinet systems.
- Relay signal #4 is normally used for the Transformer Option.
- A 12V dc output is provided as well to drive a small signal relay to operate a large contactor.

7.3.8.2 Digital User Inputs

The digital inputs allow any action to be executed at the rising and/or falling edge of the signal, by simply assigning a SCPI command for execution to that event.

For example, a digital input can be configured to enable the output at the rising edge and disable it at the falling edge of the signal. Alternatively, it can be configured to change any set point and either of those 2 events.

A total of three digital inputs are available. These following input characteristics can be programmed for each digital input (1, 2 and 3):

- **Command** to execute (a SCPI command string) at each edge. Rising and falling edges can have different commands.
- **Filter** Setting, to reduce sensitivity to short pulses that can be caused by electrical noise or some mechanical switches.

See SCPI command section 8.10.1.3 for commands that configure and read digital inputs.

7.3.8.3 Digital User Outputs

There are four programmable digital outputs (1 to 4), which can be configured to change state based on different conditions:

- 1=ON, 0=OFF it is used as general-purpose digital output, with the value set with a SCPI command.
- OUTPUT_STATE indicates output enabled (1) or disabled (0).
- FORM indicates single (1) or split/three (0).
- FAULT indicates fault (1) or no fault (0).
- TRANSIENT indicates when a transient is running/paused/stepping (1) or stopped (0).
- PROGRAM indicates when a program is in execution at steady state level (1) or manual mode (0).
- REMOTE indicates remote (1) or local (0).
- XFMR_COUPLING indicates direct (0) or transformer (1) coupling. This output is relevant only when an output transformer option is installed and configured.

Note: Each output can be also configured to invert its logic.

User defined digital inputs can be queried using the SYSTEM:DIO:OUTput# command.

Digital outputs 1 and 2 are TTL level signals (0 to 5V), and digital outputs 3 and 4 are open-drain type outputs (with an internal pull-up) that can be used to drive external relays. Each open-drain output has a current protection of 0.5A and internal clamping diode prepared to drive a relay coil.

See section 8.10.1.4 for commands that configure and read digital outputs.

7.3.9 Analog I/O Descriptions

Both analog inputs and outputs are available on the AUX I/O feature. Analog inputs are used to change output parameters such as voltage or frequency. Analog outputs are provided to allow monitoring the ADF measurements using external equipment.

7.3.9.1 Analog Inputs

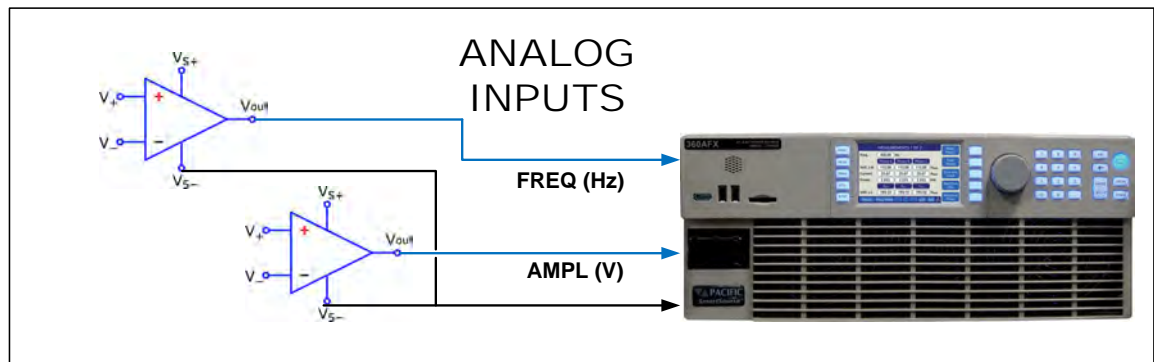

There are 4 analog inputs that accept DC signals up to 10Vdc and may be used to program the ADF output parameters such as voltage, frequency, current and power limits.

These inputs are sampled 20 times per second so updates of the assigned parameters occur at this rate. The full-scale range of the analog inputs can be programmed to be 5V, 10V or any value between 1 and 10V.

Note: Once enabled, make sure the input is not left floating or a small offset of about 2 to 3 % of full scale may be present affecting the programmed parameter. For example, when programmed to control AC voltage, no input on the analog input assigned will result in an output voltage of about 0.02 to $0.03 \times 300 = 6$ to 9 Vac.

The full-scale value for voltage programming depends on the selected operating mode. A 10V input represents 300Vac RMS.

For frequency programming, 0V represents 15Hz while 10V represents 1200Hz.

These analog inputs are all disabled by default. In order to use this feature, each analog input has to be assigned to an ADF parameter and phase, for example AC voltage of phase A.

7.3.9.2 Programming Analog Inputs

The range of the analog inputs can be changed with two parameters for each input, gain and offset. For example if an input is assigned to AC voltage programming the default gain is 300V and the offset is 0V. This means that 10V at the analog input port represents a programmed voltage of 300Vrms and 0V represents 0Vrms.

Different gain and offset combinations can be used to customize the range of the analog programming input, being the “gain” the programmed value that represents the maximum input at the analog port, and “offset” the value at 0V. For example, a gain of 150V and offset of 50V produce an output of 50V to 200V for analog programming signals of 0V to 10V.

Note: Different ADF parameters have different units (Volts, Amperes, Watts, Hertz, etc.), so when an analog input parameter is changed, the gain and offset are reset to default values (zero for offset and max full-scale values for gain).

7.3.9.3 Analog Outputs

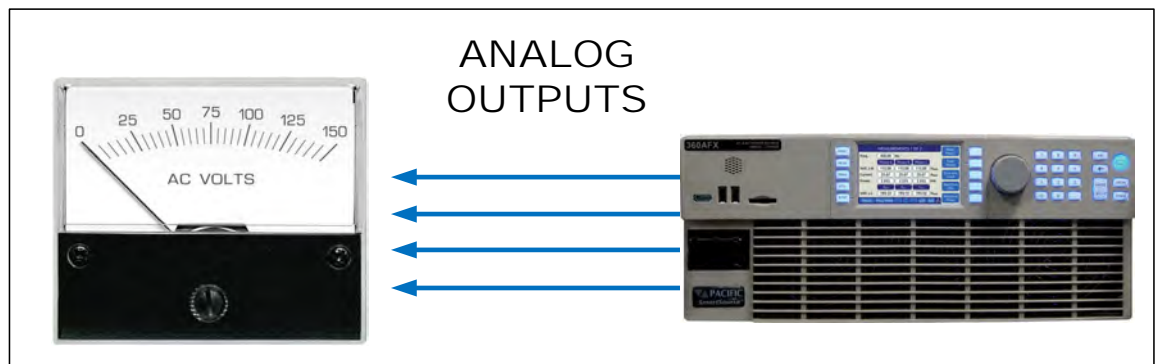

Analog outputs are available to monitor output values for voltage, current or power using external measurement equipment. A total of four analog outputs are provided, with an output voltage range of 0 to 5V. Output scaling is fully programmable for each measurement with an offset and gain.

For example, for RMS voltage measurements the default gain is 300V and offset is 0V. This means that measurements of 0 to 300V generate monitoring voltages of 0 to 5V. An offset of 50V and a gain of 150V will mean that measurements in the range of 50 to 200V will be mapped to the analog output range of 0 to 5V.

Analog outputs are available to monitor output values for voltage, current or power using external measurement equipment. A total of four analog outputs are provided. Output scaling is from 0 to 10V for zero to full scale.

Pin #	Signal	Programs
22	AO1	Volt RMS Measurements Phase A
23	AO2	Volt RMS Measurements Phase B
24	AO3	Volt RMS Measurements Phase C
25	AO4	Total Power (all phases combined)

Table 7-3: Default Analog Output Functions

7.3.10 12 DC Power Supply

A pin in the DB25 port provides a current limited, regulated 12V supply. The maximum current capability is 0.5A_{dc}.

There are no menus or commands associated with this output, as it is always active.

7.3.11 RS232 Description

The Tx and Rx signal on the AUX I/O connector may be used to connect to a serial port. Only Xon/Xoff handshake mode is supported on this RS232 port. For most situations, it is recommended to use the USB Device port for remote serial control applications.

7.3.12 Front Panel Operation of AUX I/O Functions

The auxiliary I/O functions can be configured and programmed from the front panel using the SYSTEM menu (Press SYST key to left of the LCD screen). This section describes the available AUX I/O program screens and parameters for each function.

7.3.12.1 Accessing AUX I/O Screens.

From the SYSTEM MENU, scroll to the INTERFACE entry and press the shuttle or ENTER key as indicated below. If the Interface selection is not visible, press the “More” soft key to display the second System Menu screen.

Next, scroll to the “Digital & Analog I/Os” entry at the bottom of the INTERFACE SETUP screen.

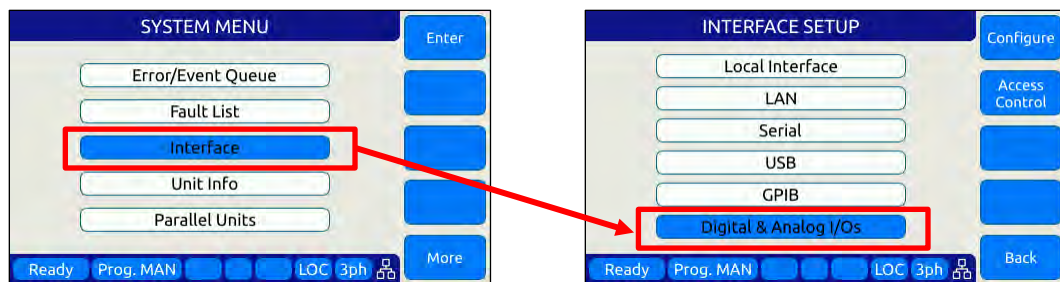

This will display a list of available Auxiliary I/O functions and features. To display the second of two DIGITAL & ANALOG I/Os screens, use the “More” soft key.



To select the desired function, use the knob to scroll up or down. Once selected, press the Shuttle knob or ENTER key to open the relevant I/O control screen.

Each screen is covered in the following sections in more detail.

7.3.12.2 Analog Inputs

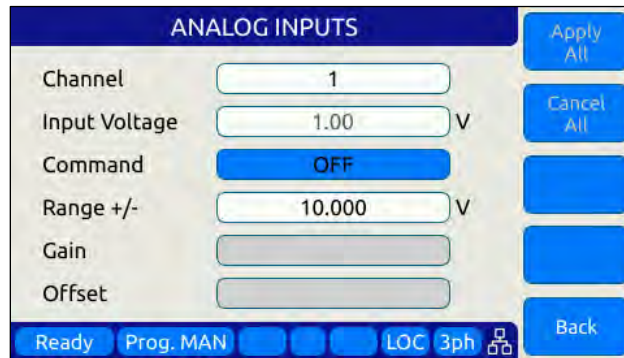

Analog inputs allow parameters settings to be controlled using DC input signals. The parameter to be controller by each of four available analog inputs can be assigned from the front panel.

Available settings or read-outs and parameter ranges are:

- CHANNEL [1 | 2 | 3 | 4]
- INPUT VOLTAGE Displays read back voltage
- COMMAND Select command from dropdown list or OFF for none. See table below
- RANGE 0.0000 to 10.000 V
- GAIN Gain
- OFFSET Offset value

The **Command** parameter allows the user to assign the selected analog input to the parameter that will be controlled by it. The list of available setting commands for these inputs is shown below.

Analog Input Command Values					
VOLT:AC	n/a	CURR:LIM	FREQ	KVA:LIM	POW:LIM
VOLT:AC1	n/a	CURR:LIM1	PHAS2	KVA:LIM1	POW:LIM1
VOLT:AC2	n/a	CURR:LIM2	PHAS3	KVA:LIM2	POW:LIM2
VOLT:AC3	n/a	CURR:LIM3	OFF	KVA:LIM3	POW:LIM3

Table 7-4: AUX I/O Analog Input assignable Commands

The Gain and Offset parameters can be used to scale and shift the input value to the desired range for min. and max. output.

7.3.12.3 Analog Outputs

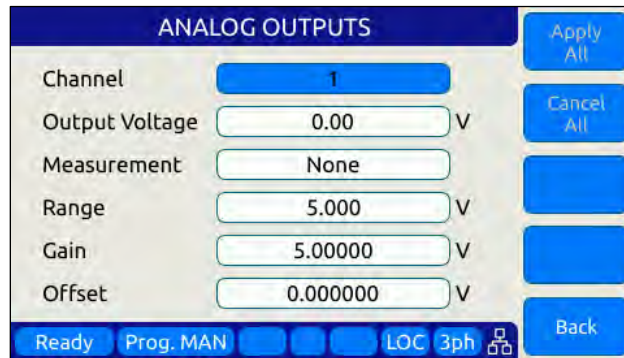

Analog outputs allow external equipment to monitor power source output values using an analog DC output signal. The assignment of measurement functions to each of four available outputs can be configured from the front panel.

Available settings are:

- CHANNEL [1 | 2 | 3 | 4]
- OUTPUT VOLTAGE Output setting
- MEASUREMENT Select measurement to be assigned to output
- RANGE 0.0000 to 5.000 V
- GAIN 0.000 to 1000
- OFFSET – 1000 to +1000

7.3.12.4 Digital Inputs

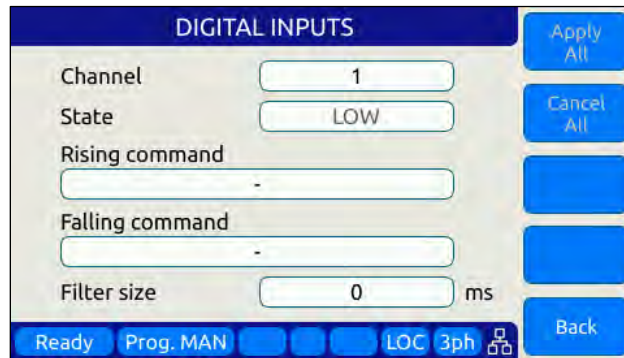

Digital Inputs allow external equipment such as PLCs. to control the power source operation. The assignment functions to each available input can be configured from the front panel.

Available settings are:

- CHANNEL [1 | 2 | 3]
- STATE Displays input state
- RISING CMD Set command string to execute on rising edge
- FALLING CMD Set command string to execute on falling edge
- FILTER SIZE 0 to 10,000,000 msec

7.3.12.5 Digital Outputs

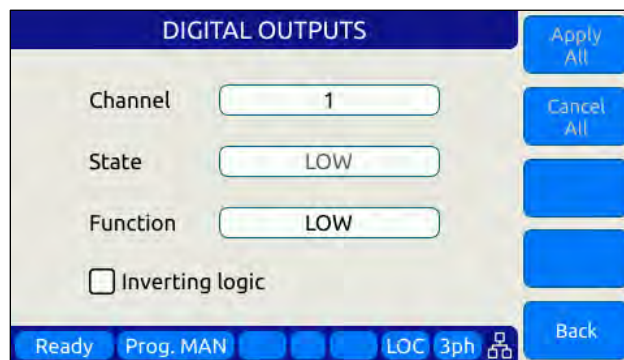

Digital Outputs can be used to trigger or control external equipment. The events assignable to each digital output can be selected using the **Function** field.

Available settings are:

- CHANNEL [1 | 2 | 3 | 4]
- STATE Displays current state
- FUNCTION Assigns state to selected channel. Available states are:
- INV. LOGIC [ON | OFF] Reverses polarity

Events that can be assigned to digital outputs are listed in the table below and can be set using the **Function** field.

Digital Output Assignable Events		
EVENT	Description	Indication
FAULT	Output goes high on fault event	1 = Fault occurred, 0 = No Fault
FORM	Output FORM state	1 = SINGLE, 0 = SPLIT/THREE
HIGH	Fixed Output high	1 = ON
LOW	Fixed Output low	0 = OFF
OUTPUT STATE	Output Relay State	1 = ON (enabled), 0 = OFF (disabled)
PROGRAM	Output goes high when Program is selected	1 = Steady State Program, 0 = Manual mode
REMOTE	Output goes high when unit is in REMOTE state	1 = REMOTE state, 0 = LOCAL state
TRANSIENT	Output goes high when transient is running	1 = Running/Paused/Stepping, 0 = Stopped
XFMR_COUPLING	Indicates output coupling mode	1 = Transformer Coupled, 0 = Direct Coupled

Table 7-5: AUX I/O Digital Output assignable Events or Conditions

7.3.12.6 Polarity Selection for DO3 and DO4 vs DO1 and DO2

The two open drain outputs DO3 and DO4 have internal 1 kΩ pull-up resistors to +5.5V. These outputs can be used as regular digital outputs (open-drain type) if needed. However, the logic will be inverted because a “direct” logic for the relay drive means an “inverted” logic for the open drain output. The FET being on means the relay coil active, but with a pull-up the output goes to low.

DO3 and DO4 use direct logic for the relay drive, which means that if the inverting logic is not active and there is a “1” written to the digital output, an internal FET will be activated causing a “low” in the open drain output.

Each digital output can be configured to have separate inverting logic, so the user can configure these 2 to be inverting and have the normal direct logic when used as open-drain outputs.

- IMMEDIATE [ON | OFF] Ignore phase update setting if ON
- AUTORUN [ON | OFF] No RUN command required if ON

7.3.12.9 Strobe Output

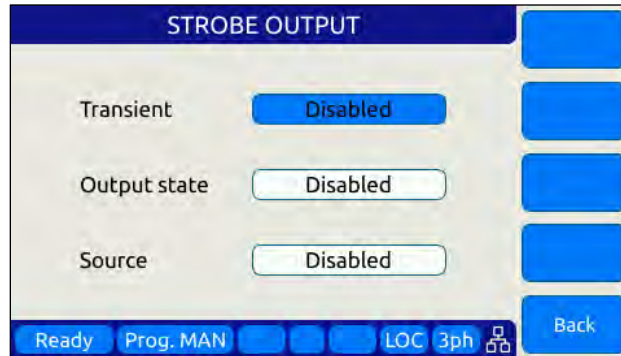

The Strobe Output is used to synchronize or trigger external equipment to an event occurring on the AC power source.

Available settings are:

- TRANSIENT ON = Strobe output on transient start
- OUTPUT STATE ON = Strobe output on relay close
- SOURCE ON = Strobe output on any program parameter change

7.3.12.10 Remote Control

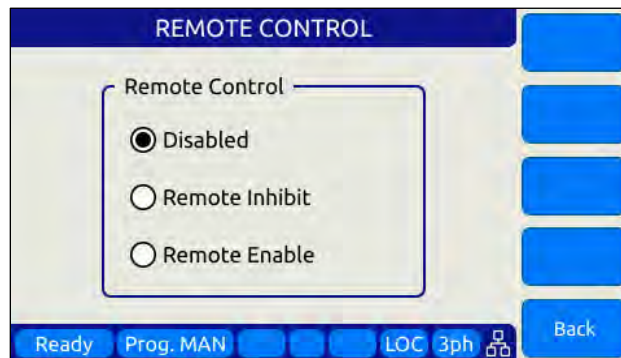

The remote control input is used to control operation of the output relay.

Available settings are:

- DISABLED No remote output control
- REMOTE INHIBIT Contact closure needed to close output relay
- REMOTE ENABLE Contact closure or front panel can control output relay

See Section 6.8.5.6.

7.4 System Interface Bus Connectors



WARNING

SHOCK HAZARD: DO NOT remove safety covers from the two System Interface DVI Connectors.



AVERTISSEMENT

RISQUE DE CHOC: NE PAS retirer les capots de sécurité des deux connecteurs d'interface DVI

The system interface bus is not user-accessible. It consists of two Digital Visual Interface (DVI-I dual link) connectors that are covered by a protective cover. There are no user accessible signals on the system interface bus. It is used for system configuration cabinet systems only.

8 Remote Control Programming

8.1 Overview

If your unit is fitted with a computer interface option then RS232, USB or LAN connector will be present on the rear panel based on the order configuration. The interface allows the power source settings to be configured remotely and measurement data to be retrieved for analysis and test report generation.

The front panel LOCAL key allows the user to restore LOCAL CONTROL unless the Bus controller has sent a LOCAL LOCKOUT (LLO) message. The Bus Controller may restore LOCAL CONTROL by sending a GOTO LOCAL (GTL) message.

8.1.1 Programming Conventions and Notations

The following conventions and notations are used in this section of the manual:

1. **COMMANDS** are shown in the left hand column in **BOLD** with **NO** underline.
2. Command **DESCRIPTIONS** appear in the right hand column.
3. SCPI is "Standard Commands for Programmable Instruments -1992". Refer to the SCPI 1992 standard for more information. The full standard publication is available from the IVI Foundation at <http://www.ivifoundation.org/>
4. Some SCPI keywords are optional, and are ignored by the device. Optional keywords are enclosed in [] brackets.
5. Lowercase letters of commands shown are also optional.
6. The SCPI standard requires uppercase text in all SCPI commands (start with :), however, the command parser is not case sensitive and will accept commands sent in lower case. It is recommended that programming formats follow the SCPI standard.
7. Some SCPI commands have query command counterparts as noted. A query command consists of the command with a question mark (?) appended at the end. Parameters cannot be sent with a query. IEEE-488.2 commands do not have query counterparts unless explicitly shown with a question mark appended.
8. IEEE488.2 common commands start with an asterisk (*) and are not case sensitive.
9. All required Functional Elements for devices are implemented.
10. All numerical values are ASCII encoded decimal strings consisting of 1 or more ASCII digits. 8 and 16 bit register values are binary weighted values represented by an ASCII string of 1 or more decimal digits. One exception, the Serial Poll byte, is an 8 bit hexadecimal byte.
11. Multiple Commands and Queries may be sent in one Program Message but each must be separated by a semicolon (;). The term 'Program Message' refers to one or more

commands and/or queries sent to the controller as one continuous string and is not to be confused with Stored Programs (1-99) within the controller.

12. Multiple data parameter names and values must be separated by commas.
13. Voltage and Waveform parameter names without a channel number suffix (1,2,3) may be used to set all 3 channels (phases) simultaneously, as an alternative to setting each separately to the same value.
14. Multiple keyword messages may be sent without duplicating the first level SCPI keyword i.e., SOURce).
e.g., :SOURce:VOLTage1,120; FREQuency,60
A keyword is a single word beginning with a colon (:).
15. Program Messages MUST be terminated with a LINE FEED (0Ahex, 10dec) or END (EOI) signal. This is referred to as an end-of-string <eos>. A Carriage Return character (0Dhex, 13dec) is converted to a LINE FEED by the power source. Further SCPI commands shall begin with a first level keyword (i.e.,:SOURce:).
16. All values shown in angle brackets <> are examples of real values used with commands but labels are sometimes used to indicate a variable which is not known until actual time of use. e.g., <AMPS meter range> might actually be <50>. Units such as AAC, Hz. or % shown after the angle bracketed value are not to be included inside the value, but are shown as a reference to the units. The angle brackets are not part of the value.
17. The controller data input buffer is 8k bytes, as is its data output buffer. No program message may exceed this length.
18. All :SOURce: commands also support queries. An alternate method of writing or reading the presently active :SOURce:FORM, COUPLing, VOLTage, FREQuency, and CURRent:LIMit values is to use PROGram 0 (see examples). PROGram 0 contains the MANUAL MODE parameters.

NOTE: Sending any :SOURce: command invokes MANUAL MODE and REMOTE CONTROL.
19. Command strings may contain spaces.
20. The controller interface accepts IEEE-488.2 <nr1>, <nr2> and <nr3> numeric formats. Most query responses are <nr1> or <nr2> types. i.e., <nr1>=120, <nr2>=120.0, <nr3>=1.2E+02.
21. Follow any command (in the same Program Message) with *OPC to detect completion of the command or termination of a Transient event. An SRQ occurs when the command or Transient is complete (if ESB bit is set in SRE and OPC bit is set in ESE). *OPC? may be used in the same manner.

8.1.2 Command Terminators

Allowable terminator characters are:

Character	ASCII	Dec value	Hex value
Carriage Return	<CR>	13	0x0d
Line Feed	<LF>	10	0x0a

8.2 Remote Control Command Descriptions by Subsystem

This section covers detailed description of the available commands by category. The following command categories are defined.

Command Subsystem	Description
CALIBRATE	These commands perform calibration functions
MEASURE	These commands are used to measure voltage, current, power and any other measurement parameters from the instrument.
OUTPUT	These command control the power source output
PROGRAM	These commands control programmed settings and transient segments
SENSE	These commands control the voltage sense modes
SOURCE	These commands are used to set instrument settings
STATUS	These commands are used to control or query status and error messages.
SYSTEM	These commands are used to control system level setting such as interfaces, special operating modes or other special instrument specific functions.

Table 8-1: Available SCPI Command Subsystems

8.3 Calibration Commands

Calibration commands allow for fully automated calibration of the power source.

Note: It is not recommended for the end user to use these command unless calibration must be automated. Any errors in using these commands could invalidate user calibration data. Pacific Power Source recommends the use of a competent and authorized calibration lab to perform routine calibration.

The following calibration commands are supported. Commands marked “UPC” are provided for backward compatibility with UPC controller based PPS power sources.

8.3.1 ADF Calibration Commands

Command Syntax	CALibrate:COEFFicients:OFFSET:VOLTage
Description	Calibrates output DC voltage offset to lowest possible level.
Parameters	None
Parameter Format	n/a
Example	CAL:OFFSET:VOLT

Command Syntax	CALibrate:COEFFicients:OFFSET:CURRent
Description	Calibrates output DC current offset to lowest possible level
Parameters	None
Parameter Format	n/a
Example	CAL:OFFSET:CURR

Command Syntax	CALibrate:COEFFicients:NOISE:VOLTage
Description	Calibrates output voltage noise to lowest possible level.
Parameters	None
Parameter Format	n/a
Example	n/a

Command Syntax	CALibrate:COEFFicients:NOISE:CURRent
Description	Calibrates output current noise to lowest possible level.
Parameters	None
Parameter Format	n/a
Example	n/a

<p>Command Syntax Description</p>	<p>CALibrate:COEFFicients:GAIN:VOLTage[:AC] <cr> Loads values measured with an external DVM for calibration of AC voltage output and metering. The first 3 values are Voltages measured at the output relay of the power source for each phase. The second set of 3 values are Voltages measured at the external voltage sense points (at the load) for each phase.</p>
<p>Parameters Parameter Format Example</p>	<p>External reference voltage readings for each phase n/a n/a</p>
<p>Command Syntax Description</p>	<p>CALibrate:COEFFicients:GAIN:CURRent[:AC] <cr> Loads values measured with an external shunt and DVM for calibration of AC current metering. The first 3 values are currents measured at the output of the power source for each phase.</p>
<p>Parameters Parameter Format Example Query Format Returned Data Format Query Example</p>	<p>External reference current reading n/a n/a No n/a n/a</p>
<p>Command Syntax Description</p>	<p>CALibrate:RESET Clears all calibration coefficients. Sending this command resets all calibration factors to defaults. After sending this command, programming and metering remains functional and will still meet spec.</p>
<p>Parameters Parameter Format Example</p>	<p>None n/a CAL:RESET</p>
<p>Query Format Description Returned Data Format Query Example</p>	<p>CALibrate:COEFFicients:ALL? Returns all eighteen calibration factors as a comma delimited list. <nr1>,...,<nr1> CAL:FACT:ALL? 0,0,0,0,0,0,0,0,0,0,0,0,0,0,0,0,0</p>
<p>Command Syntax Description</p>	<p>CALibrate:UPDATE Transfers cal factors from XML Calibration file to NVM. Required only if calibration.xml has been modified. Alternatively, the unit can be power cycled.</p>
<p>Parameters Parameter Format Example</p>	<p>None n/a n/a</p>

8.3.2 UPC Specific commands.

Following commands are included for UPC compatibility mode only and don't perform any function other than providing query responses for use with legacy software programs.

Query Format	CALibrate:VALue:XFMRATIO?
Query Format	CALibrate:VALue:AMPLIFIERS?
Command Syntax	CALibrate:KFACTORS <k_int_Va, k_int_Vb, k_int_Vc, k_ext_Va, k_ext_Vb, k_ext_Vc, k_la, k_lb, k_lc, k_osca, k_oscb, k_oscC>
Query Format	CALibrate:KFACTors:ALL?

8.3.3 AUX I/O Interface Calibration Commands

For a list of AUX I/O calibration commands, see Section 8.10.4, "AUX I/O Calibration Command" on page 287.

8.4 Measurement Commands

Measurement commands are typically queries only and return power source measurement data values. This section is broken down into the commands for each measurement parameter.

The following measurement commands are supported.

8.4.1 Voltage Measurement Commands

Query Format Description	MEASure:VOLTage[:ACDC]#? Returns the measured RMS voltage for the selected phase #. If no phase number is specified, returns the reading for the last selected phase.
Returned Data Format Query Example	<nr2> MEAS:VOLT:ACDC2? 230.0000
Query Format Description	MEASure:VOLTage:AC#? Returns the measured RMS voltage for the selected phase #. If no phase number is specified, returns the reading for the last selected phase. This command is equivalent to “MEASure:VOLTage[:ACDC]#?” and is provided for backward compatibility with the UPC controllers.
Returned Data Format Query Example	<nr2> MEAS:VOLT:AC3? 230.0000
Query Format Description	MEASure:VLL#? Returns the measured RMS Line-to-Line voltage ¹ for the selected phase #. If no phase number is specified, returns the reading for the last selected phase. Phase reference applies as follows: # = 1 V _{AB} , # = 2 V _{AC} , # = 3 V _{BC}
Returned Data Format Query Example	MEAS:VLL2? 398.3780

Note 1: Line to Line voltage measurements are calculated based on VLN and phase angles and are valid only for sinusoidal voltage waveforms with low levels of distortion and under balanced three phase load conditions.

Commands available only with Option D:

Query Format Description	MEASure:VOLTage:DC#? Returns the measured DC voltage for the selected phase #. If no phase number is specified, returns the reading for all phases.
Returned Data Format Query Example	<nr2> MEAS:VOLT:DC1? 2.2500

8.4.2 Frequency Measurement Commands

Query Format	MEASure:FREQuency#?
Description	Returns the fundamental frequency for the selected phase #. If no phase number is specified, returns the reading for the last selected phase. For frequency measurements, the phase reference is irrelevant as all phase are at the same frequency.
Returned Data Format	<nr2>
Query Example	MEAS:FREQ? 50.0000

8.4.3 Current Measurement Commands

Query Format	MEASure:CURRent[:ACDC]#?
Description	Returns the measured RMS current for the selected phase #. If no phase number is specified, returns the reading for the last selected phase.
Returned Data Format	<nr2>
Query Example	MEAS:CURR:ACDC1? 21.1587

Query Format	MEASure:CURRent:PEAK#?
Description	Returns the measured peak current for the selected phase #. If no phase number is specified, returns the reading for the last selected phase.
Returned Data Format	<nr2>
Query Example	MEAS:CURR:PEAK1? 45.5845

Query Format	MEASure:CURRent:CREST#?
Description	Returns the measured current crest factor for the selected phase #. If no phase number is specified, returns the reading for the last selected phase.
Returned Data Format	<nr2>
Query Example	MEAS:CURR:CREST1? 2.1544

Query Format	MEASure:CURRent:AC#?"
Description	Returns the measured RMS current for the selected phase #. If no phase number is specified, returns the reading for the last selected phase. This command is equivalent to "MEASure:CURRent[:ACDC]#?" and is provided for backward compatibility with the UPC controllers.
Returned Data Format	<nr2>
Query Example	MEAS:CURR:AC1? 21.1587

Commands available only with Option D:

Query Format	MEASure:CURRent:DC#?
Description	Returns the measured DC current for the selected phase #. If no phase number is specified, returns the reading for all phases.
Returned Data Format	<nr2>
Query Example	MEAS:CURR:DC1? 0.0000

8.4.4 Power Measurement Commands

Query Format	MEASure:POWer#?
Description	Returns the true power for the selected phase # in kW. If no phase number is specified, returns the reading for the last selected phase.
Returned Data Format	<nr2>
Query Example	MEAS:POWer1? 4.4203

Query Format	MEASure:POWer:MAXimum:HOLD?
Description	Returns the highest total power reading obtained for all phases. The reset this track and hold value, use the MEASure:POWer:RESET command.
Returned Data Format	<nr2>, <nr2>, <nr2>
Query Example	MEAS:POW:MAX:HOLD? 4800.0000, 4780.0000, 4687.0000

Query Format	MEASure:POWer:MINimum:HOLD?
Description	Returns the lowest total power reading obtained for all phases. If this command returns a negative value, then power has been fed back into the power source. For non-regenerative power sources, the ability to absorb energy from the load is very limited and the unit may FAULT. The reset this track and hold value, use the MEASure:POWer:RESET command.
Returned Data Format	<nr2>, <nr2>, <nr2>
Query Example	MEAS:POW:MIN:HOLD? 200.0000, -190.0000, 230.0000

Command Syntax	MEASure:POWer:RESET
Description	Clear the track and hold MINimum and MAXimum power hold readings.
Returned Data Format	<nr2>
Query Example	MEAS:POWer1? 4.4203

Query Format	MEASure:KVA#?
Description	Returns the true apparent for the selected phase # in kVA. If no phase number is specified, returns the reading for the last selected phase.
Returned Data Format	<nr2>
Query Example	MEAS:KVA1? 4.8665
Query Format	MEASure:PF#?
Description	Returns the true apparent for the selected phase # in kVA. If no phase number is specified, returns the reading for the last selected phase.
Returned Data Format	<nr2>
Query Example	MEAS:PF1? 0.9083

8.4.5 Other Measurement Commands

Query Format **MEASure:TEMPerature:AMBient?**
 Description Returns the ambient temperature of the power source in degrees celcius.
 Returned Data Format <nr1>
 Query Example MEAS:TEMP:AMB?
 24

Query Format **MEASure:ALL#?**
 Description Returns 14 parametric measurements for the selected phase # as a comma delimited string. The # is used to specify phase A, B or C using 1, 2 or 3 respectively. If phase reference is omitted, measurement data for all three phases is returned. Value order for each phase is:

All Firmware Revisions	
1. Frequency (repeats for each phase)	2. VLL AC+DC
3. VLL AC RMS	4. VLL DC
5. VLN AC+DC	6. VLN AC
7. VLN DC	8. I AC
9. I DC	10. POWER
11. APP POWER	12. I PEAK
13. PF	14. CF
FW Rev 2.0.0 ~ 2.2.15	
15. PEAK CURRENT	16. KWH
17. Elapsed Time for KWH	

Thus, each phase data set consists of 14 values. For all phases, a total of 42 comma separated values are returned.

Returned Data Format <nr2>,<nr2>,...,<nr2>,<nr2>
 Query Example MEAS:ALL1?
 1200.0000,519.5981,519.5981,0.0028,299.9990,299.9989,-
 0.0007,0.1711,-0.0016,0.0000,0.0513,0.4849,0.0000,0.0000

Query Format **MEASure:ALL:CATALOG?**
 Description Returns a comma-separated human-readable list of available measurements in the same order as the command returns it. See MEASure:ALL#? Command for parameter list as a function of Firmware revision.
Note: Available in FW Revisions 2.2.16 / 3.3.13 or higher.

Query Format	MEASure:ALL#? <OPTIONAL: List of measurements to return>
Description	Same as MEASure:ALL#? Command with optional user specified parameters list. Query command returns measurement parameters as included in list in the order they are specified by the list.
	Note: Available in FW Revisions 2.2.16 / 3.3.13 or higher.

8.4.6 Measurement Data Logging Commands

Command Syntax	MEASure:LOGger:START
Description	Starts the logging of measurements process. The process consists of taking measurements and saving them in a file. The log file can be found in the “datalogger” folder and is a comma separated value format (.csv) file. Measurements will be taken while the output is enabled only.
Parameters	None
Parameter Format	n/a
Example	MEAS:LOG:START
Query Format	None

Command Syntax	MEASure:LOGger:STOP
Description	Stops the logging process that was started with MEASure:LOGger:START.
Parameters	None
Parameter Format	n/a
Example	MEAS:LOG:STOP
Query Format	None

Query Format	MEASure:LOGger:STATe?
Description	Returns the state of the measurement data logging process as a number as follows: 0 – Stopped 1 – Running 2 – Paused
Returned Data Format	<nr1>
Query Example	MEAS:LOG:STAT? 1

<p>Command Syntax Description</p>	<p>MEASure:LOGger:LIMit <cr> Sets the number of samples to get. Once the logging process reach this limit it will stop.If the limit is set as OFF or 0 it will not stop unless MEAS:LOG:STOP is executed. The limit can be specified as a number of samples or in seconds if a character "S" is added to the number. If the limit is passed as seconds, the command will compute the number of samples based on the logging rate. The formula is: number of samples = seconds / rate. The rate can be set with: MEASure:LOGger:RATE <nr1> or queried with: MEASure:LOGger:RATE?. < OFF 0 > XS where X is a time limit in seconds X where X is the limit in number of samples</p>
<p>Parameters</p>	
<p>Parameter Format Examples</p>	<p><cr> MEAS:LOG:LIM OFF MEAS:LOG:LIM 20S MEAS:LOG:LIM 100</p>
<p>Query Format Returned Data Format Query Example</p>	<p>MEASure:LOGger:LIMit? 0 MEAS:LOG:LIM? 10000</p>
<p>Command Syntax Description</p>	<p>MEASure:LOGger:FILELimit <nr1> Sets the limit of samples to save in the file. If the limit is reached and the logging process continues, a new file will be created.</p>
<p>Parameters</p>	<p>Limit in number of samples.</p>
<p>Parameter Format Example</p>	<p><nr1> MEAS:LOG:FILEL 100</p>
<p>Query Format Returned Data Format Query Example</p>	<p>MEASure:LOGger:FILELimit? <nr1> MEAS:LOG:FILEL? 10000</p>
<p>Command Syntax Description</p>	<p>MEASure:LOGger:FILENAME <cr> Sets the data logging file name</p>
<p>Parameters</p>	<p>Filename between double quotes</p>
<p>Parameter Format Example</p>	<p><cr> MEAS:LOG:FILEN "Measurement-AC"</p>
<p>Query Format Returned Data Format Query Example</p>	<p>MEASure:LOGger:FILENAME? <cr> MEAS:LOG:FILEN? Measurement-AC</p>

Command Syntax	MEASure:LOGger:MEMory <cr>
Description	Select the memory where the logging files will be saved. By default it is RAM unless a memory stick or USB drive was inserted and selected with this command: MEAS:LOG:MEM:CAT? can be used to get the available memories. Memory name between double quotes.
Parameters	
Parameter Format	<cr>
Example	MEAS:LOG:MEM "USBA"
Query Format	MEASure:LOGger:MEMory?
Returned Data Format	<cr>
Query Example	MEAS:LOG:MEM? USBA
Query Format	MEASure:LOGger:MEMory:CATalog?
Description	Returns the catalog of available memory names.
Returned Data Format	<cr>
Query Example	MEAS:LOG:MEM:CAT? RAM, USBA
Command Syntax	MEASure:LOGger:RATE
Description	Sets the frequency at which the logging process will take measurements.
Parameters	Frequency in Hz. Range is 1 Hz through 10 Hz.
Parameter Format	<nr1>
Example	MEAS:LOG:RATE 5
Query Format	MEASure:LOGger:RATE?
Returned Data Format	<nr1>
Query Example	MEAS:LOG:RATE? 5
Command Syntax	MEASure:LOGger:TIMEstamp <cr>
Description	Sets the time stamp format that will be attached to every measurement record in the measurement log file.
Parameters	< DATE 0 TIME 1 ALL 2 >
Parameter Format	<cr>
Example	MEAS:LOG:TIME ALL
Query Format	MEASure:LOGger:TIMEstamp?
Returned Data Format	<nr1>
Query Example	MEAS:LOG:TIME? 2

8.4.7 Measurement Resolution Setting Commands

All SCPI measurement commands return measurement data in a format with a specific resolution, i.e. a certain number of digits after the decimal point. The default resolution (number of positions after the decimal point) for each parameter is chosen based on the dimension (VA or KVA) and measurement accuracy of that specific parameter.

The user can increase or decrease the number of digits for each measurement parameter if so desired by using the RESolution commands listed in this section⁵.

Note: Increasing the resolution of a measurement for any parameter does NOT improve the specified measurement's accuracy specification. As such, digits added for to any measurement may not represent meaningful information.

The generic format for this command is:

MEASure:MMMnnn:RESolution <RESOLUTION>

MEASure:MMMnnn:RESolution?

Where MMMnnn is the measurement command syntax of the measurement for which the resolution is to be set. The Query command can be used to query a command's active resolution setting.

<RESOLUTION> is a formatted number that specifies the number of digits to include in the query response. For example:

0.1	Only one digit behind the decimal point
0.0001	4 digits behind the decimal point
0.00001	6 digits behind the decimal point

Example:

MEASure:POWer:RESolution 0.00001

This changes the number of digits for True Power measurements from the default 4 to 5. Since Power measurements are reported in KW, this is equivalent to changing the measurement resolution from 0.1 W /10mW to 0.01W / 10mW. All these settings are independent of each other so only the specified measurement command's resolution will be changed. To change multiple commands, send this command for each one.

Note: Changing the resolution for any measurement command does NOT affect the displayed resolution of measurements in any of the power sources' front panel display screen. This command only affects remote control bus measurement queries.

Note: Once a command's resolution has been changed using the MEASure:MMMnnn:RESolution <RESOLUTION> command, the new resolution format is persistent, i.e. it remains in effect between power on/off cycles. To change it back, a new RESolution command must be sent.

⁵ Requires Firmware Revision 2.2.11 or higher

The following table shows the available RESolution commands.

Measurement Resolution Command	Query Format
MEASure:VOLTage:RESolution <RESOLUTION>	MEASure:VOLTage:RESolution?
MEASure:VLL:RESolution <RESOLUTION>	MEASure:VLL:RESolution?
MEASure:FREQuency:RESolution <RESOLUTION>	MEASure:FREQuency:RESolution?
MEASure:CURRent:RESolution <RESOLUTION>	MEASure:CURRent:RESolution?
MEASure:CURRent:CREST:RESolution <RESOLUTION>	MEASure:CURRent:CREST:RESolution?
MEASure:POWer:RESolution <RESOLUTION>	MEASure:POWer:RESolution?
MEASure:KVA:RESolution <RESOLUTION>	MEASure:KVA:RESolution?
MEASure:PF:RESolution <RESOLUTION>	MEASure:PF:RESolution?
MEASure:TEMPerature:RESolution <RESOLUTION>	MEASure:TEMPerature:RESolution?

8.5 Output Control Commands

The output command subsystem is used to control the output state of the power source. The following measurement commands are supported.

Command Syntax	OUTPut:FAST
Description	Enable or disable fast energy savings startup mode (STANDBY mode) when output is closed. This mode does not completely shut down all inverters for energy savings while the output is off. This allows near immediate application of output to the load when the output command is received. When disabled, there is delay of 2.2 seconds to allow all power stages to start up and settle in.
Parameters	< 0 OFF 1 ON >
Parameter Format	
Example	OUTP:FAST ON
Query Format	OUTPut:FAST?
Returned Data Format	
Query Example	OUTP:FAST? 1

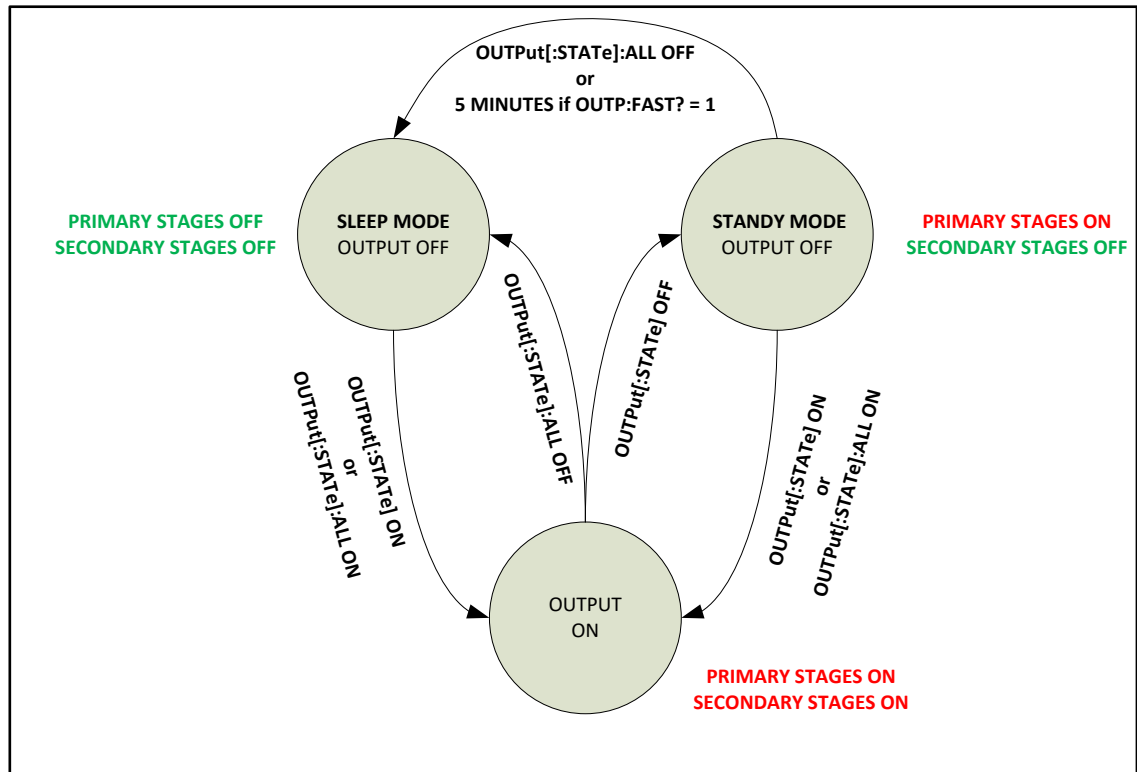

Figure 8-1: Energy Saving Modes and Output Commands State Diagram

Command Syntax Description	<p>OUTPut[:STATe]</p> <p>Enables or Disables power output. When enabled, all output relays are closed. When disabled, all output relays are open. The time it takes for the output to turn on is determined by the status of the OUTP:FAST setting.</p> <p>If the power source is in sleep mode (all power stages are off), it will take about 2.2 seconds before the output relays are closed. This is required to let all stages settle. If the power source is in standby mode, it will only take 200 msec to close the output relay as only the second (inverter) stage needs to settle.</p> <p>Note: Sending the OUTP OFF command will only cause the second stage to be turned off. The primary stages remain on and thus the AC source will be in standby mode. If OUTP:FAST = 0, the primary stages will turn off after 5 minutes of non-use and the AC source will enter sleep mode.</p> <p>Refer to section 6.2.2, “Energy Savings Modes” for more details.</p>
Parameters Parameter Format Example Query Format Returned Data Format Query Example	<p>< 0 OFF 1 ON ></p> <p></p> <p>OUTP ON</p> <p>OUTPut[:STATe]?</p> <p></p> <p>OUTP?</p> <p>1</p>
Command Syntax Description	<p>OUTPut[:STATe]:ALL</p> <p>This command enables or disables the output and is similar to the OUTPut[:STATe] command but always turns off all power stages, regardless of the energy savings mode set with the OUTP:FAST command. Thus, the OUTP:ALL OFF command will turn off all power stages and put the AC source in sleep mode.</p> <p>Note: The OUTP:ALL ON command has the same effect as the OUTP ON command.</p>
Parameters Parameter Format Example	<p>< 0 OFF 1 ON ></p> <p></p> <p>OUTP:ALL OFF</p>

Command Syntax	OUTPut[:STATe]:AUTO
Description	This commands determines the state of the OUTPUT when the power source is turned on (powered on).
OUTPut:AUTO = ON	The output will be enabled at power on IF it was ON at the time the front panel circuit breaker of the unit was switched off. Thus, the output state will revert to the last state before power-off. This command in combination with the “[SOURce:]INITial” command allows the unattended resumption of a test station after a power failure.
	Note: This condition is potentially hazardous and should be used with caution.
OUTPut:AUTO = OFF	The output will always come up in the OFF state.
Parameters	< 0 OFF 1 ON >
Parameter Format	
Example	OUTP:AUTO ON
Query Format	OUTPut[:STATe]:AUTO?
Returned Data Format	
Query Example	OUTP:AUTO? 1
Command Syntax	OUTPut:DISABLEPHase
Description	This command sets the disable phase angle. This is the phase angle on phase A at which the power source output will be disabled. Available range is 0 ~ 360. Also allows a negative number that indicates a RANDOM phase angle/
	Note: Available in units with Firmware revision 1.6.6 or higher. Refer also to the OUTPut:ZEROprogram command.
Parameters	0.0 ~ 360.0 or negative number
Parameter Format	<nr2>
Example	OUTPDISABLEPH 90.0 OUTPDISABLEPH -1
Query Format	OUTPut:DISABLEPHase?
Returned Data Format	<nr2>
Query Example	OUTP:DISABLEPH? 90.000

Query Syntax	OUTPut:DISABLEPHase:MINimum OUTPut:DISABLEPHase:MAXimum OUTPut:DISABLEPHase:DEFault
Description	<p>These query commands return minimum, maximum and default Output Disable Phase values respectively. Available range is -0.01 (Random) through 360.0.</p> <p>Note: Available in units with Firmware revision 1.6.6 or higher.</p>
Returned Data Format	<nr2>
Query Example	OUTP:DISABLEPH:MIN? -0.010 OUTP:DISABLEPH:MAX? 360.000 OUTP:DISABLEPH:DEF? 0.000
Command Syntax	OUTPut:ZEROpogram
Description	<p>This command sets the programmed output voltage to zero before opening the output relay when the OUTP OFF 0 command is sent. This feature is disabled by default but can be enabled by sending OUTP:ZERO ON 1.</p> <p>In this mode, the output of the power source goes to a low impedance state before disconnecting the load.</p> <p>Note: Available in units with Firmware revision 1.6.6 or higher. Refer also to the OUTPut:DISABLEPHase command.</p>
Parameters	< 0 OFF 1 ON >
Parameter Format	
Example	OUTP:ZERO 1
Query Format	OUTPut:ZEROpogram?
Returned Data Format	
Query Example	OUTP:ZERO? 1
Command Syntax	OUTPut:ZEROpogram:RAMP <nr1>
Description	<p>This command sets the voltage ramp down to zero time before opening the output relay when the OUTP OFF 0 command is sent. See Figure for reference. Default value is 0 msec.</p> <p><i>This command is intended for uses with XFMR units but configurable for both couplings. XFMR and direct parameters are independent. For direct coupling delay is 100ms and ramp 0ms by default but can be changed to any value. The ramp allows the voltage to reduce slowly, useful for reducing the magnetization of the transformer so at the next turn on, there is no excessive peak current due to remaining magnetization.</i></p> <p>Note: Available in units with Firmware revision 2.2.12 or higher.</p>
Parameters	Time in msec.
Parameter Format	<nr1>
Example	OUTP:ZERO:RAMP? 50
Query Format	OUTPut:ZEROpogram:RAMP?

Returned Data Format <nr1>
Query Example OUTP:ZERO:RAMP?
50

Command Syntax **OUTPut:ZEROprogram:DWELL <nr1>**
Description This command sets the voltage dwell time before opening the output relay when the OUTP OFF | 0 command is sent. See Figure for reference. Default value is 100 msec.

Note: Available in units with Firmware revision 2.2.12 or higher.
Time in msec.

Parameters
Parameter Format <nr1>
Example OUTP:ZERO:DWELL? 20

Query Format **OUTPut:ZEROprogram:DWELL?**
Returned Data Format <nr1>
Query Example OUTP:ZERO:DWELL?
20

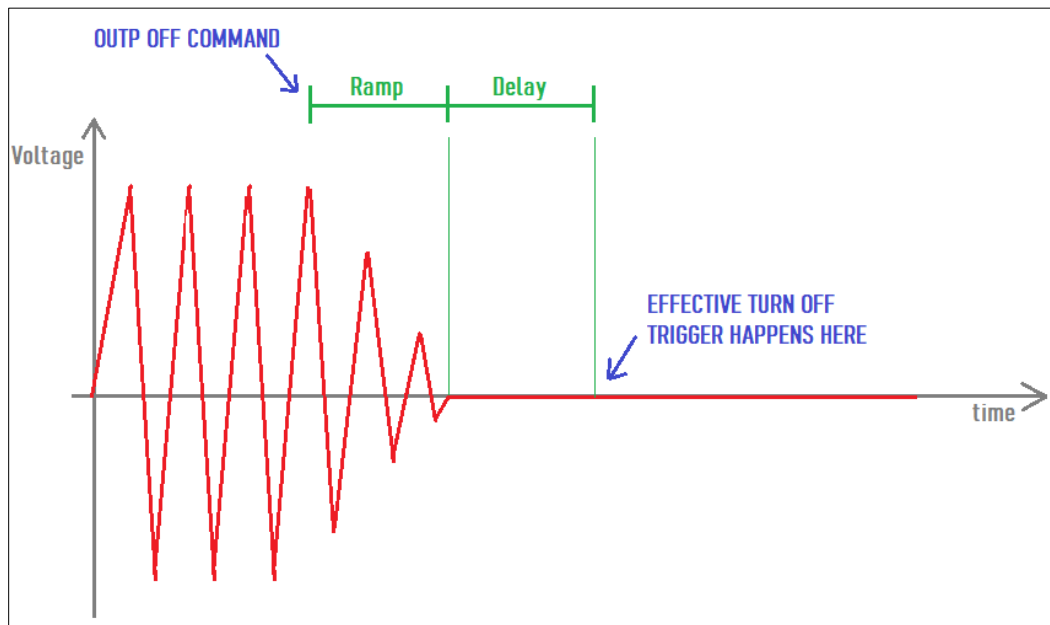

Figure 8-2: OUTP:ZERO Command Ramp and Dwell settings

8.6 Program Commands

Program commands allow management and programming of stored program segments for steady state. These commands are grouped by the following subsystems.

- Program Control Commands
- Execution Commands
- Memory Management Commands

The Program commands are similar to those found on the Pacific Power UPC controllers used for other PPS AC power source models.

8.6.1 Program Control Commands

The following commands allow recall of stored programs and transient segments. Programs are selected and recalled using their memory location reference ranging from 1 through 99. Program location zero (0) is reserved for the Manual Mode setup. Optionally, a memory source may be specified. If none is provided, INTERNAL memory is used as a default.

Command Syntax	PROG ram:NAME [<nr1>,<cr>] [<cr>,<cr>] <cr>
Description	This command selects program <nr1> for execution deletion or copying.
Parameters	Option: PROGRAM, NUMBER [<cr>} or [<nr1>] - 0 through 99 Option: MEMORY [<cr>} – Available are: INTERNAL RAM USB Parameter list define string <cr>,<cr>,<cr>,<cr>,<cr>
Parameter Format	<nr1> [<cr>]
Example	PROG:NAME 4, USB
Query Format	PROG ram:NAME?
Description	The query format of this command returns the value of last program selected. Returned value range is 0 through 99.
Returned Data Format	<nr1>
Query Example	PROG:NAME? 4

Command Syntax Description	<p>PROGram[:SElected]:DEFine [<nr1>] [<cr>] <cr></p> <p>This command programs all values stored in the selected program number. Both steady-state and transient segment parameter names and values may be sent. Program parameters are defined in the following sections.</p> <p>NOTE: Only commas may separate the values, NO Carriage Returns or Line Feeds may separate the values within a single command message.</p>
Parameters	<p>Option: PROGRAM, NUMBER [<cr>] or [<nr1>]</p> <p>Option: MEMORY [<cr>] – Available are: INTERNAL RAM USB</p> <p>Parameter list define string <cr>,<cr>,<cr>,<cr>,<cr></p>
Steady State list	<p>FORM,<n>, COUPLing,<s>, XFMRRATIO,<n.nn>, FREQuency,<n>, VOLTage,<n>, VOLTage1,<n>, VOLTage2,<n>, VOLTage3,<n>, CURRent:LIMit,<n>, CURRent:PROTect:LEVel,<n> CURRent:PROTect:TOUT,<n> PHASe2,<n>, PHASe3,<n>, WAVEFORM,<n>, WAVEFORM1,<n>, WAVEFORM2,<n>, WAVEFORM3,<n>, EVENTS,<n>, AUTORMS,<n> NSEGS, <n></p> <p style="text-align: right;">see Convention #13.</p> <p style="text-align: right;">see Convention #13.</p>
Parameter Format Example	<cr>,<cr>,<cr>,<cr>,<cr>,<cr>
Query Format Description	<p>PROGram[:SElected]:DEFine? [<nr1>] [<cr>]</p> <p>The Query format returns steady-state values of selected program and segment values of most recently selected segment or multiple segments if specified by a previous NSEGS parameter. "LAST" is returned with segment data if the segment is the last segment in the program.</p>
Returned Data Format Query Example	<p>Refer to parameter lists shown above</p> <p>PROG:DEF? 6</p> <p><nr1>, <cr>,<cr>,<cr>,<cr></p>

Example Program String:

```
FORM,3,COUPL,DIRECT,VOLT:MODE,0,CONFIG,1,RANG,1,FREQ,395.000,VOLT1,115.000,VOLT2,115.000,VOLT3,115.000,VOLT:ALC:STAT,1,CURR:OV,0,CURR:LIM1,41.670,CURR:LIM2,41.670,CURR:LIM3,41.670,IPROT:STAT,0,CURR:PROT:LEV,40.000,IPEAK:LIM,104.000,PHAS2,120.000,PHAS3,240.000,WAVEFORM1,1,WAVEFORM2,1,WAVEFORM3,1,VOLT:DC1,0.000,VOLT:DC2,0.000,VOLT:DC3,0.000,POW:LIM1,5.000,POW:LIM2,5.000,POW:LIM3,5.000,KVA:LIM1,5.000,KVA:LIM2,5.000,KVA:LIM3,5.000,PPROT:STAT,0,POW:PROT:LEV,5.000,KVA:PROT:LEV,5.000,PROT:TDELAY,1,FREQ:SLEW,5.000,VOLT:SLEW,10.000,VOLT:DC:SLEW,10.000,UPDATEPH,0.000,RAMP,1.0000,VPEAK:MARG,100.000,EVENTS,0,AUTORMS,1,NSEGS,3,SEG,3,FSEG,395.00,VSEG1,115.00,VSEG2,115.00,VSEG3,115.00,VDCSEG1,0.00,VDCSEG2,0.00,VDCSEG3,0.00,PSEG2,120.00,PSEG3,240.00,WFSEG1,1,WFSEG2,1,WFSEG3,1,TSEG,2.0000,LAST
```

8.6.1.1 Steady State Output Parameter List Table

The following table details the available parameters for the steady state program definitions.

Parameter	Description
FORM,<n>	sets Output Power Form of selected program n = <1>Single Φ , <2>Split Φ , or <3>Three Φ
COUPLing,<s>	sets Output coupling of selected program s = <DIRECT> <0> or <XFMR> <1>
XFMRRATIO,<n.nn>	sets Output XFMR ratio (n.nn:1) of selected program n.nn = <0.0100> to <5.1111>
FREQuency,<n>	sets Output Frequency of selected program n = <:SOUR:FREQ:LIM:MIN> to <:SOUR:FREQ:LIM:MAX> Hz
VOLTage,<n>	sets Output VOLTAGE Φ A,B,C of selected program n = <0> to <300 x XFMRRATIO> Volts
VOLTage1,<n>	sets Output VOLTAGE Φ A of selected program n = <0> to <300 x XFMRRATIO> Volts
VOLTage2,<n>	sets Output VOLTAGE Φ B of selected program n = <0> to <300 x XFMRRATIO> Volts
VOLTage3,<n>	sets Output VOLTAGE Φ C of selected program n = <0> to <300 x XFMRRATIO> Volts
CURRent:LIMit,<n>	sets Output Current Limit of selected program n = <0> to <AMPS meter range> Amps
CURRent:PROTect:LEVel,<n>	sets Output Current level that triggers Current Protect mode n = <0> to <AMPS meter range> Amps
CURRent:PROTect:TOUT,<n>	sets time that the Output Current must exceed the Current Protect level before Current Protect disables the power source output. n = <1> to <65535>, 1 = 100mSec.
PHASe2,120	sets Output Phase Angle B of selected program n = 120 degrees
PHASe3,240	sets Output Phase Angle C of selected program n = 240 degrees
WAVEFORM,1	sets Output Waveform Φ A, Φ B, Φ C of selected program n = 1
WAVEFORM1,1	sets Output Waveform Φ A of selected program n = 1
WAVEFORM2,1	sets Output Waveform Φ B of selected program n = 1
WAVEFORM3,1	sets Output Waveform Φ C of selected program n = 1
AUTORMS,<n>	program Transient Waveform Auto RMS mode (4.5.2) n = 0, use program steady-state waveform RMS factor n = 1, calculate RMS factor based on transient waveform

<p>Command Syntax Description</p>	<p>PROG:EXECuted:DEFine <cr> This command programs all values stored in the selected program number. Both steady-state and transient segment parameter names and values may be sent. Program parameters are defined in the following sections. NOTE: Only commas may separate the values, NO Carriage Returns or Line Feeds may separate the values within a single command message.</p>
<p>Parameters Parameter Format Example Query Format Returned Data Format Query Example</p>	<p>Refer to PROG:SElected:DEFine command <cr>,<cr>,<cr>,<cr>,<cr> PROG:EXECuted:DEFine? <cr>,<cr>,<cr>,<cr>,<cr> PROG:EXEC:DEF? -> parameter list</p>
<p>Query Format Description Parameters Query Example</p>	<p>PROG:[SElected]:DEFine:ALL? This query returns the parameter list for the selected program number or name. Option: PROGRAM, NUMBER [,<cr>} or [,<nr1>] Option: MEMORY [,<cr>}– Available are: INTERNAL RAM USB Parameter list define string <cr>,<cr>,<cr>,<cr> PROG:DEF:ALL? -> parameter list</p>
<p>Query Format Description Parameters Query Example</p>	<p>PROG:EXECuted:DEFine:ALL? This query returns the parameter list for the executing program number or name. Option: PROGRAM, NUMBER [,<cr>} or [,<nr1>] Option: MEMORY [,<cr>] Parameter list define string <cr>,<cr>,<cr>,<cr> PROG:EXEC:DEF:ALL? 3 -> parameter list</p>
<p>Command Syntax Description Parameters Parameter Format Example Query Format Returned Data Format Query Example</p>	<p>PROG:[SElected]:INfOrmation <cr> [,<nr1>] [,<cr>] This command assigns program information data to the selected program. Information string <cr> Option: PROGRAM NUMBER [,<nr1>] Option: MEMORY [,<cr>}– Available are: INTERNAL RAM USB <cr> [,<nr1>] [,<cr>] PROG:INfO 3, INTERNAL, SAMPLE TEST PROG:[SElected]:INfOrmation? [<nr1>] [,<cr>] <cr> PROG:INfO? 2, USB -> Program info string</p>

Command Syntax **PROGRAM:EXECuted:INfOrMation <cr> [,<nr1>] [,<cr>]**
Description This command assigns program information data to the executing program.
Parameters Information string <cr>
Option: PROGRAM NUMBER [,<nr1>]
Option: MEMORY [,<cr>]– Available are: INTERNAL | RAM | USB
Parameter Format <cr> [,<nr1>] [,<cr>]
Example PROG:EXEC:INFO 3, INTERNAL, SAMPLE TEST
Query Format **PROGRAM:EXECuted:INfOrMation? [,<nr1>] [,<cr>]**
Returned Data Format <cr>
Query Example PROG:EXEC:INFO? 2, USB
-> Program info string

Command Syntax **PROGRAM[:SElected]:ALIAS <cr> [,<nr1>] [,<cr>]**
Description This command assigns a user provided alias string name to the selected program. Program number and memory type are optional parameters.
Parameters Alias String <cr>
Option: PROGRAM NUMBER [,<nr1>]
Option: MEMORY [,<cr>]– Available are: INTERNAL | RAM | USB
Parameter Format <cr> [,<nr1>] [,<cr>]
Example PROG:ALIAS TEST1
Query Format **PROGRAM[:SElected]:ALIAS? [,<nr1>] [,<cr>]**
Returned Data Format <cr>
Query Example PROG:ALIAS?
TEST1

Command Syntax **PROGRAM:EXECuted:ALIAS <cr> [,<nr1>] [,<cr>]**
Description This command assigns a user provided alias string name to the executing program. Program number and memory type are optional parameters.
Parameters Alias String <cr>
Option: PROGRAM NUMBER [,<nr1>]
Option: MEMORY [,<cr>]– Available are: INTERNAL | RAM | USB
Parameter Format <cr> [,<nr1>] [,<cr>]
Example PROG:EXEC:ALIAS TEST2
Query Format **PROGRAM:EXECuted:ALIAS? [,<nr1>] [,<cr>]**
Returned Data Format <cr>
Query Example PROG:EXEC:ALIAS?
TEST2

<p>Query Format Description</p>	<p>PROGram[:SElected]:SST? [,<nr1>] [,<cr>] This command returns the Steady State Table settings of the selected program only. The transient table data is not returned.</p>
<p>Parameters</p>	<p>Option: PROGRAM NUMBER [,<nr1>] Option: MEMORY [,<cr>]– Available are: INTERNAL RAM USB</p>
<p>Returned Data Format Query Example</p>	<p><cr> PROG:SST? 2, USB -> steady state table program data</p>
<p>Query Format Description</p>	<p>PROGram:EXECuted:SST? [,<nr1>] [,<cr>] This command returns the Steady State Table settings of the executing program only. The transient table data is not returned.</p>
<p>Parameters</p>	<p>Option: PROGRAM NUMBER [,<nr1>] Option: MEMORY [,<cr>]– Available are: INTERNAL RAM USB</p>
<p>Returned Data Format Query Example</p>	<p><cr> PROG:EXEC:SST? -> steady state table program data</p>
<p>Query Format Description</p>	<p>PROGram[:SElected]:TT? [,<nr1>] [,<cr>] This command returns the Transient Table settings of the selected program only. The steady state table data is not returned.</p>
<p>Parameters</p>	<p>Option: STYLE [,<nr1>] 0 = Human readable Style A (default if omitted) 1 = Human readable Style B 2 = Binary Data Format. Can be more useful to search for differences between programs. See PROGram:TT? Command for formats</p>
<p>Returned Data Format Query Example</p>	<p>Option: PROGRAM NUMBER [,<nr1>] Option: MEMORY [,<cr>]– Available are: INTERNAL RAM USB <cr> PROG:TT? 1 -> transient table program data</p>

<p>Query Format Description</p>	<p>PROGram[:SElected]:CHECK? [,<nr1>] [,<cr>]</p> <p>This command performs a check on the selected program steady state tables looking for the following conditions:</p> <ul style="list-style-type: none"> • Hardware Limit violations • User Limit violations • Saturation limits. <p>If no violations are present, this command returns OK and the program can be executed without generating any errors. If the selected program cannot be run due to one or more issues with its content, one or more errors detailing the issues will be returned. For example, if the upper voltage user limit is set to 100V and the program contains a setting of 300V, a “Cannot load program, Run PROGRAM:CHECK?” error will be generated when attempting to execute this program. When sending the PROGRAM:CHECK? Query, the response will be “VOLT1 AC voltage set point cannot change due to user limit”.</p>
<p>Parameters</p>	<p>Option: PROGRAM NUMBER [,<nr1>]</p> <p>Option: MEMORY [,<cr>]– Available are: INTERNAL RAM USB</p>
<p>Returned Data Format</p>	<p><cr></p>
<p>Query Example</p>	<p>PROG:CHECK?</p> <p>VOLT1 AC voltage set point cannot change due to user limit</p>
<p>Query Format Description</p>	<p>PROGram:EXECuted:CHECK? [,<nr1>] [,<cr>]</p> <p>This command serves the same purpose as the PROG:CHECK? Command but applies to a program that is executing.</p>
<p>Parameters</p>	<p>Option: PROGRAM NUMBER [,<nr1>]</p> <p>Option: MEMORY [,<cr>]– Available are: INTERNAL RAM USB</p>
<p>Returned Data Format</p>	<p><cr></p>
<p>Query Example</p>	<p>PROG:EXEC:CHECK?</p> <p>VOLT1 AC voltage set point cannot change due to user limit</p>
<p>Command Syntax Description</p>	<p>PROGram[:SElected]:DElete</p> <p>This command deletes the selected program. Attempting to DElete an EXECuting Program will result in an Error.</p>
<p>Parameters</p>	<p>Program number</p>
<p>Parameter Format</p>	<p><nr1></p>
<p>Example</p>	<p>PROG:DEL 9</p>

Query Format	PROGram[:SElected]:CHANges? <nr1>, <cr>
Description	This command compares the program that is executing with another program stored in the memory type and location passed as parameters. The results of the comparison is returned as a decimal number ranging from 0 to 15 representing a four bit binary value. This result can be decoded as shown below.
Parameters	Option: PROGRAM NUMBER [,<nr1>] Option: MEMORY [,<cr>]– Available are: INTERNAL RAM USB
Returned Data Format	<nr>1
Decoding	Bit 0: If set to 1, there are differences in the steady state table (SST) Bit 1: If set to 1, there are differences in the transient table (TT) Bit 2: If set to 1, there are differences in the ALIAS of the program Bit 3: If set to 1, there are differences in INFOrmation of the program
Query Example	PROG:CHAN? 16
Example	If the query returns zero (0), the program executing is identical to the stored program referenced. If the command returns three (3), the program executing has differences with the referenced program in both the steady state table and the transient table.
Command Syntax	PROGram[:SElected]:COPY <nr1> [,<cr>]
Description	This command copies the selected program as previously specified by the PROG:NAME <nr1> command to destination program number. NOTE: The destination Program specified cannot be currently executing.
Parameters	DESTINATION PROGRAM NUMBER <nr1> Option: MEMORY [,<cr>]– Available are: INTERNAL RAM USB
Parameter Format	<nr1>, [,<cr.>]
Example	PROG:COPY 2, USB
Command Syntax	PROGram:EXECuted:COPY <nr1> [,<cr>]
Description	This command copies the executed program to destination program number.
Parameters	DESTINATION PROGRAM NUMBER <nr1> Option: MEMORY [,<cr>]– Available are: INTERNAL RAM USB
Parameter Format	<nr1>, [,<cr.>]
Example	PROG:EXEC:COPY 2, USB

8.6.2 Execution Commands

The following commands may be used to control stored program executions.

Command Syntax	PROG [: SE lected]: EXEC ute [<nr1> [,<cr>]
Description	This command executes the selected program (default) or the program number passed as the first parameter.
Parameters	Option: PROGRAM NUMBER [,<nr1>] Option: MEMORY [,<cr>]– Available are: INTERNAL RAM USB
Parameter Format	[<nr1> [,<cr>]
Example	PROG:EXEC 2
Query Format	PROG [: SE lected]: EXEC ute ?
Description	The query format returns the number of the program that is in effect.
Parameter Format	<nr1>
Example	PROG:EXEC? 23

8.6.3 Memory Management Commands

The Program memory subsystem commands allow management of Program memory contents.

Command Syntax	PROG:MEMory <cr>
Description	This command selects the specific program memory type for storing and retrieving programs. Default is INTERNAL memory. Alternatives are RAM and USB devices. The memory type can also be specified as an optional parameter with several PROG:MEM commands where indicated in this manual.
Parameters	Memory types: INTERNAL RAM USB. For a complete list of available memory types, use the "PROG:MEMory:CATalog?" Command.
Parameter Format	<cr>
Example	PROG:MEM USB
Query Format	PROG:MEMory?
Returned Data Format	<cr>
Query Example	PROG:MEM? USB
Query Format	PROG:MEMory:CATalog?
Description	This query command returns a comma separated list of available memory types that can be selected for storage of steady state and transient table information.
Returned Data Format	INTERNAL, RAM, SD1, SD2, SD3, USB
Memory Types	INTERNAL = Internal Flash Memory. (Default selection) RAM = Internal RAM. Content will be lost when power source is turned off. USB[X][Y] = USB memory stick devices. X = port number, Y = partition number SD[Y] = SC Card, Y = partition number X = symbolizes different memory sticks connected to various available USB ports. Y = symbolizes different logical partitions on a USB memory stick or SD card. INTERNAL and RAM are always available. INTERNAL is default selection. Use the "PROG:MEMory <cr>" command to select active memory selection.
Query Example	PROG:MEM:CAT? INTERNAL,RAM,USBA1

<p>Query Format Description</p>	<p>PROG:EXECuted:MEMory?</p> <p>This command selects the specific program memory type for storing and retrieving programs. Default is INTERNAL memory. Alternatives are RAM and USB devices. The memory type can also be specified as an optional parameter with several PROG:EXEC commands where indicated in this manual.</p>
<p>Parameters Parameter Format Example Query Format Returned Data Format Query Example</p>	<p>Memory types: INTERNAL RAM USB</p> <p><cr></p> <p>PROG:EXEC:MEM USB</p> <p>PROG:EXECuted:MEMory?</p> <p><cr></p> <p>PROG:EXEC:MEM?</p> <p>USB</p>
<p>Command Syntax Description</p>	<p>PROG:POWOn <nr1></p> <p>Returns the number of the stored program that will be recalled at power on.</p>
<p>Parameters Parameter Format Example Query Format Returned Data Format Query Example</p>	<p>Program number</p> <p><nr1></p> <p>PROG:POWO 1</p> <p>PROG:POWOn?</p> <p><nr1></p> <p>PROG:POWO?</p> <p>1</p>
<p>Command Syntax Description</p>	<p>PROG:DELeTe:ALL <cr></p> <p>This command deletes all programs, waveforms and setup values, performs device RESET, loads Program #1 with *RST default values, executes MANUAL MODE with *RST values. Waveforms (1-16) are re-loaded from internal Flash memory. Attempting to DELeTe an EXECuting Program will result in an error message.</p>
<p>Parameters Parameter Format Example</p>	<p>Optional: Memory type: INTERNAL RAM USB</p> <p><cr></p> <p>PROG:DEL:ALL USB</p>
<p>Query Format Description</p>	<p>PROG:CATalog? <cr></p> <p>This query returns a comma separated list of <nr1> values representing stored programs (e.g. 1,2,7...). If the MANUAL MODE program setup exists, the list will include 0. If no programs are stored at all, this query returns a 1</p>
<p>Parameters Parameter Format Returned Data Format Query Example</p>	<p>Optional: Memory type: INTERNAL RAM USB</p> <p><cr></p> <p><nr1>,<nr1>,...,<nr1>,<nr1></p> <p>PROG:CAT?</p> <p>0,1,2,9,12</p> <p>PROG:CAT? INTERNAL</p> <p>0</p>

Query Format	PROG:m:CRC? <cr>
Description	This query command calculates and returns the checksum value of the selected program. This CRC may be used to verify the program data integrity is intact. This command is provided for UPC compatibility mode and not recommended for new programs.
Parameters	Optional: Memory type: INTERNAL RAM USB
Parameter Format	<cr>
Returned Data Format	<nr1>
Query Example	PROG:CRC? RAM 08ad55
Query Format	PROG:m:BROWse?
Description	This command returns the list of available programs stored in the memory selected or passed as a parameter.
Parameters	Optional: Memory type: INTERNAL RAM USB
Parameter Format	<cr>
Returned Data Format	<nr1>, <nr1>,.....,<nr1>
Query Example	PROG:BROW? 1,8,9,23

8.7 Source Commands

Source commands control the settings of the power source. This includes all operating modes, voltages, frequency, current and power limits and phase angles as well as transient operation. Since the SOURCE subsystem is the primary system, the SOURce portion of these commands is optional. The following status commands are supported broken down by SOURCE sub groups.

8.7.1 Source Configuration Programming Commands

Command Syntax	[SOURce:]CONFIG
Description	Selects alternative loop compensation mode for improved transient response. The effect of this command depends on the selected output mode as follows:
Parameters	AC Mode: Changes the AC loop compensation.
Parameter Format	< 0 1 > (0 = Normal loop, 1 = Faster Loop)
Example	
Query Format	SOUR:CONFIG 1
Returned Data Format	[SOURce:]CONFIG?
Query Example	
	CONFIG?
	0
Command Syntax	[SOURce:]CONFIG:AC
Description	Selects alternative AC loop compensation mode for improved AC transient response.
	The effect of this command depends on the selected output mode as follows:
Parameters	AC Mode: Changes the AC loop compensation
Parameter Format	< 0 1 > (0 = Normal loop, 1 = Faster Loop)
Example	
Query Format	SOUR:CONFIG:AC 1
Returned Data Format	[SOURce:]CONFIG:AC?
Query Example	
	CONFIG:AC?
	0

Command Syntax	[SOURCE:]CONFIG:HFreq
Description	This command enables high-frequency output current protection extension mode. In this mode, the protection for high frequency content at the output of the power source is held off for up to 2 seconds to allow short time events to ride through without tripping the normal protection mode. Note: Available in units with Firmware revision 1.6.6 or higher.
Parameters	< 0 OFF 1 ON > (0 = Off, 1 = On)
Parameter Format	
Example	SOUR:CONFIG:HF 1
Query Format	[SOURCE:]CONFIG:HFreq?
Returned Data Format	
Query Example	CONFIG:HF? 1

Command Syntax	[SOURce:]INITial <n>
Description	<p>Sets source output settings initialization mode. This command in combination with the "OUTPut[:STATE]:AUTO" command allows the unattended resumption of a test station after a power failure.</p> <p>Note: This condition is potentially hazardous and should be used with caution.</p>
[SOURce:]INITial? = ON	<p>Set points of the unit at power on will be the last set after power off. The set points affected by this command are:</p> <ul style="list-style-type: none"> - Frequency - Voltage AC1 - Voltage AC2 - Voltage AC3 - 0 - 0 - 0 - Form (THREE , SPLIT or SINGLE) - Range (High or Low) - Compatibility Mode (UPC or NORMAL)
[SOURce:]INITial? = OFF	<p>Set points of the unit at power on will have a default value of:</p> <ul style="list-style-type: none"> - Frequency = 60Hz - Voltage AC1 = 0V - Voltage AC2 = 0V - Voltage AC3 = 0V - 0 - 0 - 0 - Form = THREE - Range = HIGH - Compatibility = NORMAL
Parameters	< 0 OFF 1 ON >
Parameter Format	
Example	:INIT ON
Query Format	[SOURce:]INITial?
Returned Data Format	
Query Example	INIT? 0

Command Syntax Description	[SOURce:]RANGe Selects high or low voltage range. Although the ADF Series® has only a single voltage range, this commands allows simulation of a dual range AC voltage source which is more familiar to some users. Despite this virtual low range capability, no actual physical range change takes place so the output is never interrupted. Note: When switching from HIGH to LOW range, the output voltage may be reduced to the highest available voltage on the low range.
Parameters Parameter Format Example Query Format Returned Data Format Query Example	< 0 LOW 1 HIGH > RANG HIGH [SOURce:]RANGe? RANG? 1
Command Syntax Description	[SOURce:]RAMP# Sets voltage slew rate for selected phase number or for all phases if no phase number is specified.
Parameters Parameter Format Example Query Format Description	Slew rate <nr2> SOUR:RAMP3 10.5 [SOURce:]RAMP#?
Returned Data Format Query Example	Returns voltage slew rate setting for specified phase (1, 2 or 3) or for phase 1 (A) if no phase number is specified. SOUR:RAMP3? 10.5000
Command Syntax Description	[SOURce:]UPDATEPHase Set the phase angle at which programmed voltage changes on phase A will take place. This applies to output on and off phase angle placement as well. Available range is from 0° through 360.0° inclusive. Values higher than 360.0° will be truncated to 360.0000° automatically.
Parameters Parameter Format Example Query Format Returned Data Format Query Example	< 0.0000 - 360.0000 > <nr2> UPDATEPH 90.00 [SOURce:]UPDATEPHase? <nr2> SOURce:UPDATEPH? 90.0000

8.7.2 Voltage Programming Commands

Note that most of the voltage programming commands are phase specific so in three or split phase mode, each phase voltage can be individually programmed. This is done by appending 1, 2 or 3 for the “#” symbol shown in the syntax below. If the “#” value is omitted, all available phase (1, 2 or 3 in single, split or three phase mode respectively) will be set to the same amplitude. This allows the same program code to be used for any phase mode as long as the phase amplitudes need to be balanced.

The following command sets each phase to a different amplitude when in three phase mode.

```
SOUR:VOLT:AC1 15;;SOUR:VOLT:AC2 30;;SOURCE:VOLT:AC3 45
```

This command sets all phases to the same amplitude, regardless of phase mode:

```
SOUR:VOLT:AC 100
```

The query format for these phase specific commands will return the value for the phase number appended to the command. If the phase number reference is omitted, the setting for phase 1 (A) is returned.

Command Syntax	[SOURce:]VOLTage:CSC[:STATE#] [SOURce:]CSC:STATE#
Description	Turns the Continuous Source Calibration (CSC) mode on or off.
Parameters	<0 OFF 1 ON>
Parameter Format	
Example	VOLT:CSC ON
Query Format	[SOURce:]VOLTage:CSC[:STATE]?
Returned Data Format	<nr1>
Query Example	VOLT:CSC? 1
Command Syntax	[SOURce:]VOLTage[:AC]#
Description	Sets AC voltage for phase #. If # is omitted, sets all available phases to value specified.
Parameters	Range 0.0000 - 300.0000
Parameter Format	<nr2>
Example	VOLT:AC1 100.00
Query Format	[SOURce:]VOLTage[:AC]#?
Description	Returns voltage setting for specified phase. If phase is omitted, returns voltage setting for phase A.
Returned Data Format	<nr2>
Query Example	VOLT:AC1? 100.0000

Command Syntax	[SOURCE:]VOLTage[:AC]#:SLEW
Description	Sets AC voltage slew rate for phase # in Volts per msec. If # is omitted, sets phase A slew rate to value specified.
Parameters	Range 0.01 – 300.0
Parameter Format	<nr2> and <nr3>
Example	VOLT:AC1:SLEW 300.00
Query Format	[SOURCE:]VOLTage[:AC]#:SLEW?
Description	Returns voltage slew rate setting for specified phase. If phase is omitted, returns voltage setting for phase A.
Returned Data Format	<nr2>
Query Example	VOLT:AC1:SLEW? 300.0000
Command Syntax	[SOURCE:]VOLTage[:AC]:LIMit:MINimum
Description	Sets low user limit for AC voltage programming. User limits must fall within actual hardware limits of the power source. Also, MIN limit must be less than MAX limit.
Parameters	0.000 – 300.000
Parameter Format	<nr2>
Example	VOLT:LIM:MIN 20.0
Query Format	[SOURCE:]VOLTage[:AC]#:LIMit:MINimum?
Returned Data Format	<nr2>
Query Example	VOLT:LIM:MIN? 20.0000
Command Syntax	[SOURCE:]VOLTage[:AC]:LIMit:MAXimum
Description	Sets high user limit for AC voltage programming. User limits must fall within actual hardware limits of the power source. Also, MAX limit must be greater than MIN limit.
Parameters	0.000 – 300.000
Parameter Format	<nr2>
Example	VOLT:LIM:MAX 240.0
Query Format	[SOURCE:]VOLTage[:AC]#:LIMit:MAXimum?
Returned Data Format	<nr2>
Query Example	VOLT:LIM:MAX? 240.0000
Query Format	[SOURCE:]VOLTage[:AC]#:LIMit:RANGe?
Description	Returns available AC voltage range low and high limits.
Returned Data Format	<nr2>,<nr2>
Query Example	VOLT:AC1:LIM:RANG? 0.0000,300.0000

Query Format Description	<p>[SOURCE:]VOLTage[:AC]#:LIMIT:SATuration:RANGe?</p> <p>Returns the upper and lower limit sine wave RMS voltage at which saturation of the output inverter will occur. Saturation limits are determined in the maximum peak voltage capability of the AC components at the output of the power source. For the ADF Series®, these limits are -425Vp and +425Vp. The VOLT:AC1:LIM:SAT:RANG? returns the min and max. RMS of a sine wave that may be programmed.</p> <p>Maximum allowable values are: Maximum positive peak voltage: $V_peak_max = V_AC_peak_max$ Minimum negative peak voltage: $V_peak_min = V_AC_peak_min$ For a sinusoidal AC waveform, these limits are: $V_{rms_sat} = (425 - V_{dc}) / 1.4142$ $V_{rms_sat} = (-425 + V_{dc}) / 1.4142$</p>
Examples	$425 = 1.41 * 300$ ($V_AC_rms_sat = 300$)
Returned Data Format Query Example	<nr2> VOLT:AC3:LIM:SAT:RANG? 300.5204
Query Format Description	<p>[SOURCE:]VOLTage[:AC]#:LIMIT:SATuration:MAXimum?</p> <p>Returns maximum sine wave RMS voltage at which saturation of the output inverter will occur.</p> <p>See [SOURCE:]VOLTage[:AC]#:LIMIT:SATuration:RANGe? for details.</p>
Returned Data Format Query Example	<nr2> VOLT:AC3:LIM:SAT:MAX? 301.154
Query Format Description	<p>[SOURCE:]VOLTage[:AC]#:LIMIT:SATuration:MINimum?</p> <p>Returns minimum sine wave RMS voltage at which saturation of the output inverter will occur.</p> <p>See [SOURCE:]VOLTage[:AC]#:LIMIT:SATuration:RANGe? for details.</p>
Returned Data Format Query Example	<nr2> VOLT:AC3:LIM:SAT:MIN? 0.000

Command Syntax	[SOURce:]VOLTage[:AC]:INITial
Description	This command is equivalent to the “[SOURce:]INITial <n>” command but applies only to the AC1, AC2 and AC3 parameters.
VOLT:INIT? = ON	Set points of the unit at power on will be the last set after power off. The set points affected by this command are: - Voltage AC1 - Voltage AC2 - Voltage AC3
VOLT:INIT? = OFF	Set points of the unit at power on will have a default value of: - Voltage AC1 = 0V - Voltage AC2 = 0V - Voltage AC3 = 0V
Parameters	< 0 OFF 1 ON >
Parameter Format	
Example	VOLT:AC:INIT OFF
Query Format	[SOURce:]VOLTage[:AC]:INITial?
Returned Data Format	
Query Example	VOLT:AC:INIT? 0

Command Syntax	[SOURce:]VOLTage:EXTend
Description	Available only on ADF models with Option V. This command grants access to a higher voltage range extension mode. When enabled, AC voltage settings up to 333V L-N are supported.
Parameters	[0 OFF 1 2] 0 = Off, 312Vac max. 1 = 320Vac max 2 = 333Vac max
Parameter Format	<bool>
Example	VOLT:EXT 1
Query Format	[SOURce:]VOLTage:EXTend?
Returned Data Format	<nr1>
Query Example	VOLT:EXT? 1

Commands available only with Option D:

Command Syntax	[SOURce:]VOLTage:DC#
Description	Sets DC voltage for phase #. If # is omitted, sets all available phases to value specified. Note: Source must be in DC or AC+DC mode and UPC compatibility mode must be disabled.
Parameters	Range 0.0000 - 425.0000
Parameter Format	<nr2>
Example	VOLT:DC1 375.0
Query Format	[SOURce:]VOLTage:DC#?
Returned Data Format	<nr2>
Query Example	VOLT:DC1? 375.0000

<p>Command Syntax Description</p>	<p>[SOURCE:]VOLTage:DC#:SLEW Sets DC voltage slew rate for phase #. If # is omitted, sets all available phases to value specified. Note: Source must be in DC or AC+DC mode and UPC compatibility mode must be disabled.</p>
<p>Parameters Parameter Format Example Query Format Returned Data Format Query Example</p>	<p>Range 0.01- 850.00 <nr2> and <nr3> VOLT:DC1:SLEW 850.00 [SOURCE:]VOLTage:DC#:SLEW? <nr2> VOLT:DC1:SLEW? 850.0000</p>
<p>Command Syntax Description</p>	<p>[SOURCE:]VOLTage:DC#:LIMit:MINimum Sets low user limit for DC voltage programming for phase #. If # is omitted, sets all available phases to value specified. User limits must fall within actual hardware limits of the power source. Also, MIN limit must be less than MAX limit.</p>
<p>Parameters Parameter Format Example Query Format Returned Data Format Query Example</p>	<p>-425.0 – 425.0 <nr2> VOLT:LIM:DC1:MIN 20.0 [SOURCE:]VOLTage:DC#:LIMit:MINimum? <nr2> VOLT:DC1:LIM:MIN? -425.000</p>
<p>Command Syntax Description</p>	<p>[SOURCE:]VOLTage:DC#:LIMit:MAXimum Sets upper user limit for DC voltage programming for phase #. If # is omitted, sets all available phases to value specified. User limits must fall within actual hardware limits of the power source. Also, MIN limit must be less than MAX limit.</p>
<p>Parameters Parameter Format Example Query Format Returned Data Format Query Example</p>	<p>-425.0 – 425.0 <nr2> VOLT:LIM:DC1:MAX 270.0 [SOURCE:]VOLTage:DC#:LIMit:MAXimum? <nr2> VOLT:DC1:LIM:MAX? -425.000</p>
<p>Query Format Description</p>	<p>[SOURCE:]VOLTage:DC#:LIMit:RANGe? This query returns both upper and lower user limits for DC voltage programming.</p>
<p>Returned Data Format Query Example</p>	<p><nr2>,<nr2> VOLT:DC1:LIM:RANG? -425.0000,425.0000</p>

Query Format Description	<p>[SOURCE:]VOLTage:DC#:LIMit:SATuration:RANGe?</p> <p>Returns maximum DC voltage at which saturation of the output inverter will occur. Saturation limits are determined in the maximum peak voltage capability of the AC+DC components at the output of the power source. For the ADF Series®, these limits are -425 and +425V. The VOLT:DC1:SAT? returns the max. DC level that may be programmed based on the programmed AC wave shape and RMS level.</p> <p>Maximum allowable values are: Maximum positive peak voltage: $V_DC = V_peak_max - V_AC_peak_max$ Minimum negative peak voltage: $V_DC = V_peak_min + V_AC_peak_min$</p>
Examples	<p>$V_AC = 300Vrms$ sine wave $V_DC = 425 - 1.41 * 300$ (V_DC_sat = 0) $V_AC = 120Vrms$ sine wave $V_DC = 425 - 1.41 * 120$ (V_DC_sat = 255) $V_AC = 0Vrms$ $V_DC = 425 - 0$ (V_DC_sat = 425)</p>
Returned Data Format Query Example	<p><nr2> VOLT:DC1:LIM:SAT:RANG? -225, + 225</p>
Query Format Description	<p>[SOURCE:]VOLTage:DC#:LIMit:SATuration:MAXimum?</p> <p>Returns maximum sine wave RMS voltage at which saturation of the output inverter will occur. See [SOURCE:]VOLTage:DC#:LIMit:SATuration:RANGe? for details.</p>
Returned Data Format Query Example	<p><nr2> VOLT:DC3:LIM:SAT:MAX? 254.946</p>
Query Format Description	<p>[SOURCE:]VOLTage:DC#:LIMit:SATuration:MINimum?</p> <p>Returns minimum sine wave RMS voltage at which saturation of the output inverter will occur. See [SOURCE:]VOLTage:DC#:LIMit:SATuration:RANGe? for details.</p>
Returned Data Format Query Example	<p><nr2> VOLT:DC3:LIM:SAT:MIN? -254.946</p>

Commands available only with Option V:

Command Syntax	[SOURce:]VOLTage:EXTend
Description	This command grants access to a higher voltage range extension mode. When enabled, AC voltage settings up to 333V L-N are supported.
Parameters	[0 OFF 1 2] 0 = Off, 312Vac max. 1 = 320Vac max 2 = 333Vac max
Parameter Format	<bool>
Example	VOLT:EXT 1
Query Format	[SOURce:]VOLTage:EXTend?
Returned Data Format	<nr1>
Query Example	VOLT:EXT? 1

8.7.3 Frequency Programming Commands

Command Syntax	[SOURce:]FREQUency
Description	Sets output frequency for all phases.
Parameters	45.00 – 500.0 For ADF models with Option F. 15.00 – 1200.0
Parameter Format	<nr2>
Example	FREQ 400.0
Query Format	[SOURce:]FREQUency?
Returned Data Format	<nr2>
Query Example	FREQ? 400.0000
Command Syntax	[SOURce:]FREQUency:LIMit:MINimum
Description	Sets the lower user limit for frequency programming. Not that the lower limit set value must be less than the upper limit set value or an error will be generated and no change to the set value will take place. The lower limit set value must fall within the source specified frequency range capability.
Parameters	45.00 – 500.0 For ADF models with Option F. 15.00 – 1200.0
Parameter Format	<nr2>
Example	FREQ:LIM:MIN 47.0
Query Format	[SOURce:]FREQUency:LIMit:MINimum?
Returned Data Format	<nr2>
Query Example	FREQ:LIM:MIN? 47.0000
Command Syntax	[SOURce:]FREQUency:LIMit:MAXimum
Description	Sets the upper user limit for frequency programming. Note that the upper limit set value must be greater than the lower limit set value or an error will be generated and no change to the set value will take place. The upper limit set value must fall within the source specified frequency range capability.
Parameters	45.00 – 500.0 For ADF models with Option F. 15.00 – 1200.0
Parameter Format	<nr2>
Example	FREQ:LIM:MAX 63.0
Query Format	[SOURce:]FREQUency:LIMit:MAXimum?
Returned Data Format	<nr2>
Query Example	FREQ:LIM:MAX? 63.0000

Query Format	[SOURCE:]FREQuency:LIMit:RANGe?
Description	This command returns the lower and upper frequency user limit set value.s
Returned Data Format	<nr2>, <nr2>
Query Example	FREQ:LIM:RANG? 53.0000,63.0000
Command Syntax	[SOURCE:]FREQuency:SLEW
Description	Sets the frequency slew rate in Hz/msec.
Parameters	0.01 – 1200.00
Parameter Format	<nr2>
Example	FREQ:SLEW 100.0
Query Format	[SOURCE:]FREQuency:SLEW?
Returned Data Format	<nr2>
Query Example	FREQ:SLEW? 100.0000
Query Format	[SOURCE:]FREQuency:SPAN?
Description	This command is provided to support backward compatibility with Pacific Power UPC controllers. Refer also to the “ SYSTem:COMPAtible ” command. For ADF Series®, this query always returns 1200.0000
Returned Data Format	<nr2>
Query Example	FREQ:SPAN? 1200.0000

8.7.4 Current Programming Commands

Command Syntax	[SOURCE:]CURRent:LIMit#
Description	This command sets the programmable current level for the selected phase #. If # is omitted, sets all phases to current level specified. The value set cannot exceed the maximum current capability of the power source as returned by the “ [SOURCE:]CURRent:LIMit#:MAX? ” command. If the load current exceeds the current limit set point, the source will go into constant current mode to maintain the load current at the set limit level.
Parameters	0.00 – MAX
Parameter Format	<nr2>
Example	CURR:LIM 20.5
Query Format	[SOURCE:]CURRent:LIMit#?
Returned Data Format	<nr2>
Query Example	CURR:LIM? 41.667,41.667,41.667

Query Format		[SOURce:]CURRent:LIMit#:MAX?
Description		This command returns the maximum available programmable current limit setting. Note that the returned value is a function of the “ SYSTem:COMPAtible ” setting
	UPC	If UPC mode is enabled, this command always returns 2000.0000 to emulate the UPC controllers
	DISABLED	With UPC mode disabled, this command returns the max. available current output per phase. This value is a function of the ADF model and the number of units that are connected in parallel.
Returned Data Format		<nr2>
Query Example		CURR:LIM:MAX? 41.6667
Query Format		[SOURce:]CURRent:LIMit#:DEFault?
Description		This command returns the default current limit setting at power up for the referenced phase.
Returned Data Format		<nr2>
Query Example		CURR:LIM1:DEF? 41.67
Query Format		[SOURce:]CURRent:LIMit#:MAXimum?
Description		This command returns the maximum current limit setting available for the referenced phase.
Returned Data Format		<nr2>
Query Example		CURR:LIM:MAX1? 41.67
Query Format		[SOURce:]CURRent:LIMit#:MINimum?
Description		This command returns the minimum current limit setting available for the referenced phase.
Returned Data Format		<nr2>
Query Example		CURR:LIM:MIN1? 0.000

<p>Command Syntax Description</p>	<p>[SOURCE:]CURRENT:LIMIT:AUTO This commands enables or disables the Auto Current Limit function. This function automatically adjusts the programmed current limit level as a function of programmed voltage along the constant power curve of the voltage range. For example: On a 3150ADF model in three phase mode, if VOLT = 0 and CURR:LIM = 41.67 and voltage is changed to V = 300, the CURR:LIM will change to: 5000 VA / 300 Vac = 16.0. If CURR:LIM:AUTO = OFF then the CURR:LIM setting will remain at 41.67A and the power source will power limit at 5000VA instead if the load draws more than 16Aac.</p>
<p>Parameters Parameter Format Example Query Format Returned Data Format Query Example</p>	<p>< 0 OFF 1 ON > CURR:LIM:AUTO ON [SOURCE:]CURRENT:LIMIT:AUTO? CURR:LIM:AUTO? 1</p>
<p>Command Syntax Description Parameters Parameter Format Example Query Format Returned Data Format Query Example</p>	<p>[SOURCE:]CURRENT:OVERLOAD This command turns the overload current mode on or off [0 OFF 1 ON] SOUR:CURR:OV ON [SOURCE:]CURRENT:OVERLOAD? CURR:OV? 1</p>

8.7.5 Phase Programming Commands

Command Syntax	[SOURCE:]PHASe:ROTation
Description	This command sets default phase rotation at power on. Available settings are POSITIVE (1) or NEGATIVE (0). This setting effectively swaps phases B and C and may be used to set the required phase rotation for AC motors.
Parameters	[0 NEGative 1 POSitive] 0 = NEGATIVE 1 = POSITIVE
Parameter Format	
Example	PHAS:ROT POS
Query Format	[SOURCE:]PHASe:ROTation?
Returned Data Format	
Query Example	PHAS:ROT? 1
Command Syntax	[SOURCE:]PHASe:SPLIT
Description	This command sets the split phase mirroring mode. This mode allows non-symmetrical AC arbitrary waveforms to be used when in split phase mode. Default state is on.
Parameters	[0 OFF 1 ON] 0 = OFF 1 = ON
Parameter Format	
Example	PHAS:SPLIT ON
Query Format	[SOURCE:]PHASe:SPLIT?
Returned Data Format	
Query Example	PHAS:SPLIT? 1

8.7.6 Voltage Protection Programming Commands

Note: For all protection commands, # = Phase 1, 2 or 3 select or omit for all phases.

Command Syntax	[SOURce:]PROTeCt:PEAK:VOLTage#:STATe
Description	This command enables or disables the peak voltage protection.
Parameters	< 0 OFF 1 } ON >
Parameter Format	
Example	PROT:PEAK:VOLT1:STAT 1
Query Format	[SOURce:]PROTeCt:PEAK:VOLTage#:STATe?
Returned Data Format	<nr1>
Query Example	PROT:PEAK:VOLT1:STAT? 1
Command Syntax	[SOURce:]PROTeCt:PEAK:VOLTage:MODE <MARGIn LEVel BOTH>
Description	This command sets the maximum voltage peak margin. If the output voltage peak exceeds the programmed peak level by more than this amount, an error is tripped.
Parameters	<MARGIn 0 LEVel 1 BOTH 2 >
	Encoding:
	MARGIn 0 Relative level
	LEVel 1 Absolute level
	BOTH 2 Both
Parameter Format	<cr> <nr1>
Example	PROT:PEAK:VOLT:MODE BOTH
Query Format	[SOURce:]PROTeCt:PEAK:VOLTage:MODE?
Returned Data Format	<nr2>
Query Example	PROT:PEAK:VOLT:MODE? 2
Command Syntax	[SOURce:]PROTeCt:PEAK:VOLTage:MARGIn <VOLTAGE MARGIN>
Description	This command sets the maximum voltage peak margin. If the output voltage peak exceeds the programmed peak margin by more than this amount, an error is tripped.
Parameters	<VOLTAGE MARGIN>
Parameter Format	<nr2>
Example	PROT:PEAK:VOLT:MARG 120.0
Query Format	[SOURce:]PROTeCt:PEAK:VOLTage:MARGIn?
Returned Data Format	<nr2>
Query Example	PROT:PEAK:VOLT:MARG? 120.000
Query Syntax	[SOURce:]PROTeCt:PEAK:VOLTage:MARGIn:MINimum?
Description	This command returns the minimum voltage peak margin setting.
Query Example	PROT:PEAK:VOLT:MARG:MIN? 0.000

Query Syntax	[SOURCE:]PROTECT:PEAK:VOLTage:MARGin:MAXimum?
Description	This command returns the maximum voltage peak margin setting
Query Example	PROT:PEAK:VOLT:MARG:MAX? 500.000
Query Syntax	[SOURCE:]PROTECT:PEAK:VOLTage:MARGin:DEFault?
Description	This command returns the default voltage peak margin setting
Query Example	PROT:PEAK:VOLT:MARG:DEF? 100.000
Command Syntax	[SOURCE:]PROTECT:PEAK:VOLTage:LEVel <VOLTAGE LEVEL>
Description	This command sets the maximum voltage peak level. If the output voltage peak exceeds the programmed peak level by more than this amount, an error is tripped.
Parameters	<VOLTAGE LEVEL>
Parameter Format	<nr2>
Example	PROT:PEAK:VOLT:LEV 120.0
Query Format	[SOURCE:]PROTECT:PEAK:VOLTage:LEVel?
Returned Data Format	<nr2>
Query Example	PROT:PEAK:VOLT:LEV? 500.000
Query Syntax	[SOURCE:]PROTECT:PEAK:VOLTage:LEVel:MINimum?
Description	This command returns the minimum voltage peak level setting.
Query Example	PROT:PEAK:VOLT:LEV:MIN? 0.000
Query Syntax	[SOURCE:]PROTECT:PEAK:VOLTage:LEVel:MAXimum?
Description	This command returns the maximum voltage peak level setting
Query Example	PROT:PEAK:VOLT:LEV:MAX? 500.000
Query Syntax	[SOURCE:]PROTECT:PEAK:VOLTage:LEVel:DEFault?
Description	This command returns the default voltage peak level setting
Query Example	PROT:PEAK:VOLT:LEV:DEF? 500.000
Query Syntax	[SOURCE:]PROTECT:PEAK:VOLTage:TRIPped?
Description	This command returns 1 if the voltage peak protection has been tripped or 0 if no trip occurred.
Query Example	PROT:PEAK:VOLT:TRIP? 0.000
Command Syntax	[SOURCE:]PROTECT:PEAK:VOLTage:TRIPped:CLEar

Description	This command clears the peak voltage protection trip status. Once cleared, the power source output can be re-enabled.
Parameters	<VOLTAGE LEVEL>
Parameter Format	<nr2>
Example	PROT:PEAK:VOLT:TRIP:CLE

8.7.7 Current Protection Programming Commands

Note: For all protection commands, # = Phase 1, 2 or 3 select or omit for all phases.

Command Syntax	[SOURCE:]PROTECT[:RMS]:CURRENT[:STATE] <ON OFF>
Description	This command enables or disables the rms current protection. If the protection is tripped the power source output is disabled.
Parameters	< ON 1 OFF 0 >
Parameter Format	<nr1> <cr>
Example	PROTECT:CURRENT ON
Query Format	[SOURCE:]PROTECT[:RMS]:CURRENT[:STATE]?
Returned Data Format	<nr2>
Query Example	PROTECT:CURRENT? 1

Command Syntax	[SOURCE:]PROTECT[:RMS]:CURRENT:LEVEL <LEVEL>
Description	This command sets the rms current protection level.
Parameters	< LEVEL >
Parameter Format	<nr2>
Example	PROT:CURR:LEVEL 40.0
Query Format	[SOURCE:]PROTECT[:RMS]:CURRENT:LEVEL?
Returned Data Format	<nr2>
Query Example	PROT:CURR:LEV? 40.000

Query Syntax	[SOURCE:]PROTECT[:RMS]:CURRENT:LEVEL:MINIMUM?
Description	This command returns the minimum rms current protection level setting.
Query Example	PROT:CURR:LEV:MIN? 0.000

Query Syntax	[SOURCE:]PROTECT[:RMS]:CURRENT:LEVEL:MAXIMUM?
Description	This command returns the maximum rms current protection level setting.
Query Example	PROT:CURR:LEV:MAX? 41.667

Query Syntax Description Query Example	[SOURCE:]PROTECT[:RMS]:CURRENT:LEVEL:DEFAULT? This command returns the default rms current protection level setting. This value will be a function of the power source model. PROT:CURR:LEV:DEF? 41.667
Command Syntax Description Parameters Parameter Format Example Query Format Returned Data Format Query Example	[SOURCE:]PROTECT[:RMS]:CURRENT:TDELAY <DELAY> This command sets the rms current protection trip delay in 100 msec increments, i.e. as setting of 5 means 500 msec. < DELAY > <nr1> PROTECT:CURR:TDELAY 5 [SOURCE:]PROTECT[:RMS]:CURRENT:TDELAY? <nr1> PROT:CURR:LEV? 5
Query Syntax Description Query Example	[SOURCE:]PROTECT[:RMS]:CURRENT:TDELAY:MINIMUM? This command returns the minimum rms current protection trip delay setting. PROT:CURR:TDELAY:MIN? 0
Query Syntax Description Query Example	[SOURCE:]PROTECT[:RMS]:CURRENT:TDELAY:MAXIMUM? This command returns the maximum rms current protection trip delay setting. PROT:CURR:TDELAY:MAX? 3000
Query Syntax Description Query Example	[SOURCE:]PROTECT[:RMS]:CURRENT:TDELAY:DEFAULT? This command returns the default rms current protection trip delay setting. [SOURCE:]PROTECT[:RMS]:CURRENT:TDELAY:DEFAULT? 41.667
Query Syntax Description Query Example	[SOURCE:]PROTECT[:RMS]:CURRENT:TRIPPED? This command returns rms current protection trip status. Returns 1 if tripped or 0 if not. PROT:CURR:TRIP? 41.667

Command Syntax	[SOURce:]PROTeCt[:RMS]:CURRent:TRIPped:CLEAr
Description	This command clears the rms current protection trip status. Once cleared, the power source output can be enabled.
Parameters	None
Parameter Format	n/a
Example	PROT:CURR:TRIP:CLE

8.7.8 Power Protection Programming Commands

Command Syntax	[SOURce:]POWer:LIMit#
Description	This command sets the programmable true power limit level in kW for phase #. If # is omitted, all available phases are set to the value specified. The max available power for a phase can be obtained using the [SOURce:]POWer:LIMit#:MAX? query command.
Parameters	Limit value in kW
Parameter Format	<nr2>
Example	POW:LIM 2.5
Query Format	[SOURce:]POWer:LIMit#?
Returned Data Format	<nr2>
Query Example	POW:LIM1? 2.5000

Query Format	[SOURce:]POWer:LIMit#:MAX?
Description	Returns maximum available true power capability for the specified phase # in kW. If # is omitted, returns maximum available power level for last phase selected. Typically, this value will be the same for all phases.
Returned Data Format	<nr2>
Query Example	POW:LIM1:MAX? 5.0000

Command Syntax	[SOURce:]POWer:PROTeCt:LEVel
Description	This command sets the power protection trip level in kW for all available phases. If the true power of any phase exceeds this trip level, the power source will shut off the output to protect the load.
Parameters	True power trip limit level in kW
Parameter Format	<nr2>
Example	POW:PROT:LEV 2.7555
Query Format	[SOURce:]POWer:PROTeCt:LEVel?
Returned Data Format	<nr2>
Query Example	POW:PROT:LEV? 2.7555

<p>Command Syntax Description</p>	<p>[SOURCE:]KVA:LIMit# This command sets the programmable apparent power limit level in kVA for phase #. If # is omitted, all available phases are set to the value specified. The max available apparent power for a phase can be obtained using the [SOURCE:]KVA:LIMit#:MAX? query command.</p>
<p>Parameters Parameter Format Example Query Format Returned Data Format Query Example</p>	<p>Limit value in kVA <nr2> KVA:LIM 2.5 [SOURCE:]KVA:LIMit#? <nr2> POW:LIM1? 2.5000</p>
<p>Query Format Description</p>	<p>[SOURCE:]KVA:LIMit#:MAX? Returns maximum available apparent power capability for the specified phase # in kVA. If # is omitted, returns maximum available apparent power level for last phase selected. Typically, this value will be the same for all phases.</p>
<p>Returned Data Format Query Example</p>	<p><nr2> KVA:LIM1:MAX? 5.0000</p>
<p>Query Format Description</p>	<p>[SOURCE:]MODE#? Returns protection mode for the selected phase # (# = 1, 2, or 3). If # is omitted, returns protection mode for all phases in comma separated format. Note: When the phase suffix is 1, 2 or 3 the possible return categories are from 0 to 4. With suffix is omitted, this command will return MIXED(5) if modes for each phase are not the same. For example, if in split phase mode phase A (suffix 1) is in VOLTAGE mode but phase B (suffix 2) is in CURRENT mode, the query SOUR:MODE? you will return MIXED: SOUR:MODE1? = VOLTAGE and SOUR:MODE2? = CURRENT -> SOUR:MODE? = MIXED If both or phases are set to the same mode, the actual mode will be returned: SOUR:MODE1? = VOLTAGE and SOUR:MODE2? = VOLTAGE -> SOUR:MODE? = VOLTAGE</p>
<p>Returned Data Format</p>	<p><cr> Available protection modes: 0 = NONE 1 = VOLTAGE 2 = CURRENT 3 = POWER 4 = KVA 5 = MIXED</p>
<p>Query Example</p>	<p>SOUR:MODE? VOLTAGE, VOLTAGE, VOLTAGE</p>

Command Syntax	[SOURCE:]PROTECT[:RMS]:POWER#[[:STATE] <ON OFF>
Description	This command turns the true power protection on or off.
Parameters	< 0 OFF 1 ON >
Parameter Format	 <cr>
Example	PROT:POW ON
Query Format	[SOURCE:]PROTECT[:RMS]:POWER#[[:STATE]?
Returned Data Format	
Query Example	PROT:POW? 1
Command Syntax	[SOURCE:]PROTECT[:RMS]:POWER#:LEVEL <LEVEL>
Description	This command sets the true power protection trip level. Setting is in KW.
Parameters	< LEVEL >
Parameter Format	<nr2>
Example	PROT:POW:LEV 5
Query Format	[SOURCE:]PROTECT[:RMS]:POWER#:LEVEL?
Returned Data Format	
Query Example	PROT:POW:LEV? 5.000
Query Syntax	[SOURCE:]PROTECT[:RMS]:POWER:LEVEL:MINIMUM?
Description	This command returns the minimum true power protection level setting.
Query Example	PROT:POW:LEV:MIN? 0.000
Query Syntax	[SOURCE:]PROTECT[:RMS]:POWER:LEVEL:MAXIMUM?
Description	This command returns the maximum true power protection level setting.
Query Example	PROT:POW:LEV:MAX? 41.667
Query Syntax	[SOURCE:]PROTECT[:RMS]:POWER:LEVEL:DEFAULT?
Description	This command returns the default true power protection level setting. This value will be a function of the power source model.
Query Example	PROT:POW:LEV:DEF? 41.667

Command Syntax	[SOURCE:]PROTECT[:RMS]:POWER#:TDELAY <DELAY>
Description	This command sets the true power protection trip delay time. Setting is in multiples of 100 msec so 5 equals 500 msec.
Parameters	< LEVEL >
Parameter Format	<nr2>
Example	PROT:POW:LEV 5
Query Format	[SOURCE:]PROTECT[:RMS]:POWER#:TDELAY?
Returned Data Format	
Query Example	PROT:POW:TDELAY? 5.000
Query Syntax	[SOURCE:]PROTECT[:RMS]:POWER:TDELAY:MINimum?
Description	This command returns the minimum true power protection trip delay time setting.
Query Example	PROT:POW: TDELAY:MIN? 0
Query Syntax	[SOURCE:]PROTECT[:RMS]:POWER:TDELAY:MAXimum?
Description	This command returns the maximum true power protection trip delay time setting.
Query Example	PROT:POW: TDELAY:MAX? 3000
Query Syntax	[SOURCE:]PROTECT[:RMS]:POWER:TDELAY:DEFault?
Description	This command returns the default true power protection trip delay time setting.
Query Example	PROT:POW:TDELAY:DEF? 5
Query Syntax	[SOURCE:]PROTECT[:RMS]:POWER#:TRIPped?
Description	This command returns the true power protection trip status. Returns 1 if tripped or 0 if not.
Query Example	PROT:POW:TRIP? 41.667
Command Syntax	[SOURCE:]PROTECT[:RMS]:POWER#:TRIPped:CLEar
Description	This command clears the true power protection trip status. Once cleared, the power source output can be enabled.
Parameters	None
Parameter Format	n/a
Example	PROT:POW:TRIP:CLE

Command Syntax	[SOURCE:]PROTECT[:RMS]:KVA#[:STATE] <ON OFF>
Description	This command turns the apparent power protection on or off.
Parameters	< 0 OFF 1 ON >
Parameter Format	 <cr>
Example	PROT:POW ON
Query Format	[SOURCE:]PROTECT[:RMS]:KVA#[:STATE]?
Returned Data Format	
Query Example	PROT:KVA? 1
Command Syntax	[SOURCE:]PROTECT[:RMS]:KVA#:LEVEL <LEVEL>
Description	This command sets the apparent power protection trip level. Setting is in KW.
Parameters	< LEVEL >
Parameter Format	<nr2>
Example	PROT:POW:LEV 5
Query Format	[SOURCE:]PROTECT[:RMS]:KVA#:LEVEL?
Returned Data Format	
Query Example	PROT:KVA:LEV? 5.000
Query Syntax	[SOURCE:]PROTECT[:RMS]:KVA:LEVEL:MINIMUM?
Description	This command returns the minimum apparent power protection level setting.
Query Example	PROT:KVA:LEV:MIN? 0.000
Query Syntax	[SOURCE:]PROTECT[:RMS]:KVA:LEVEL:MAXIMUM?
Description	This command returns the maximum apparent power protection level setting.
Query Example	PROT:KVA:LEV:MAX? 41.667
Query Syntax	[SOURCE:]PROTECT[:RMS]:KVA:LEVEL:DEFAULT?
Description	This command returns the default apparent power protection level setting. This value will be a function of the power source model.
Query Example	PROT:KVA:LEV:DEF? 41.667

Command Syntax	[SOURCE:]PROTECT[:RMS]:KVA#:TDELAY <DELAY>
Description	This command sets the apparent power protection trip delay time. Setting is in multiples of 100 msec so 5 equals 500 msec.
Parameters	< LEVEL >
Parameter Format	<nr2>
Example	PROT:KVA:LEV 5
Query Format	[SOURCE:]PROTECT[:RMS]:KVA#:TDELAY?
Returned Data Format	
Query Example	PROT:KVA:TDELAY? 5.000
Query Syntax	[SOURCE:]PROTECT[:RMS]:KVA:TDELAY:MINimum?
Description	This command returns the minimum apparent power protection trip delay time setting.
Query Example	PROT:KVA: TDELAY:MIN? 0
Query Syntax	[SOURCE:]PROTECT[:RMS]:KVA:TDELAY:MAXimum?
Description	This command returns the maximum apparent power protection trip delay time setting.
Query Example	PROT:KVA: TDELAY:MAX? 3000
Query Syntax	[SOURCE:]PROTECT[:RMS]:KVA:TDELAY:DEFault?
Description	This command returns the default apparent power protection trip delay time setting.
Query Example	PROT:KVA:TDELAY:DEF? 5
Query Syntax	[SOURCE:]PROTECT[:RMS]:KVA#:TRIPped?
Description	This command returns the apparent power protection trip status. Returns 1 if tripped or 0 if not.
Query Example	PROT:KVA:TRIP? 41.667
Command Syntax	[SOURCE:]PROTECT[:RMS]:KVA#:TRIPped:CLEar
Description	This command clears the apparent power protection trip status. Once cleared, the power source output can be enabled.
Parameters	None
Parameter Format	n/a
Example	PROT:KVA:TRIP:CLE

8.7.9 Frequency Protection Programming Commands

Command Syntax	[SOURCE:]PROTECT:RMS:UF#:LEVEL <FREQ LEVEL>
Description	This command sets the under-frequency level. If the output frequency drops below the programmed level, an error is tripped.
Parameters	<VOLTAGE LEVEL>
Parameter Format	<nr2>
Example	PROT:RMS:UF1:LEV 45.0
Query Format	[SOURCE:]PROTECT:RMS:UF#:LEVEL?
Returned Data Format	<nr2>
Query Example	PROT:RMSUV:LEV? 45.000
Command Syntax	[SOURCE:]PROTECT:RMS:UF#:STATE
Description	This command sets the under frequency level. If the output frequency drops below the programmed level, an error is tripped.
Parameters	< 0 1 >
Parameter Format	
Example	PROT:RMS:UV1:STAT 1
Query Format	[SOURCE:]PROTECT:RMS:UF#:STATE?
Returned Data Format	<nr1>
Query Example	PROT:RMS:UV1:STAT? 1

8.8 Status Commands

Status commands control status and event registers. These commands are aliases for some of the IEEE488.2 common commands and may be used interchangeably. Refer to section 8.12, “Status and Events Registers” for details on status and event register configurations.

The following status commands are supported.

Command	Description
STATus:OPERation[:EVENT]?	Queries the Operation Status Event Register
STATus:OPERation:CONDition?	Queries the Operation Status Condition Register
STATus:OPERation:ENABLE <nr1>	Sets the Operation Status Enable Register
STATus:OPERation:ENABLE?	Queries the Operation Status Enable Register
STATus:QUESTionable[:EVENT]?	Queries the Questionable Status Event Register
STATus:QUESTionable:CONDition?	Queries the Questionable Status Condition Register
STATus:QUESTionable:ENABLE <nr1>	Sets the Questionable Status Enable Register
STATus:QUESTionable:ENABLE?	Queries the Questionable Status Enable Register
STATus:PRESet	Presets the Status Registers

Query Format	STATus:OPERation[:EVENT]?
Description	Queries the Operation Status Event Register.
Returned Data Format	<nr1>
Query Example	STAT:OPER? 0

Query Format	STATus:OPERation:CONDition?
Description	Queries the Operation Status Condition Register.
Returned Data Format	<nr1>
Query Example	STAT:OPER:COND? 0
Command Syntax	STATus:OPERation:ENABLE <nr1>
Description	Sets the content Operation Status Enable Register.
Parameters	0-32767
Parameter Format	<nr1>
Example	STAT:OPER:ENAB 255
Query Format	STATus:OPERation:ENABLE?
Returned Data Format	<nr1>
Query Example	STAT:OPER:ENAB? 6144
Query Format	STATus:QUESTionable[:EVENT]?
Description	Queries the Questionable Status Event Register.
Returned Data Format	<nr1>
Query Example	STAT:QUES? 0
Query Format	STATus:QUESTionable:CONDition?
Description	Queries the Questionable Status Condition Register.
Returned Data Format	<nr1>
Query Example	STAT:QUES:COND? 0
Command Syntax	STATus:QUESTionable:ENABLE
Description	Sets the content of the Questionable Status Enable Register.
Parameters	0-32767
Parameter Format	<nr1>
Example	STAT:QUES:ENAB 255
Query Format	STATus:QUESTionable:ENABLE?
Returned Data Format	<nr1>
Query Example	STAT:QUES:ENAB? 255
Command Syntax	STATus:PRESet
Description	The Status Preset command presets the Status Registers. The Operational Status Enable Register is set to 0 and the Questionable Status Enable Register is set to 0.
Parameters	None
Parameter Format	n/a
Example	STAT:PRES

8.9 System Commands

Systems commands control system level functions or return model and revision information on the connected unit. The following system commands are supported.

8.9.1 System Error Commands

Query Format **SYSTem:ERRor[:NEXT]?**
Description This command returns next available error message from the error queue. If no more error messages are available, returns 0, "NO ERROR" result. Available error messages are:

Returned Data Format	ERROR	Description
	-0, "No error"	No error detected
	-100, "Command error"	indicates invalid command or query received
	-102, "Command error: Syntax error."	Incorrect command syntax
	-200, "Execution error"	indicates can't execute command with parameters received
	-222, "Command error: Data out of range."	Data exceeds available parameter range
	-300, "Device-specific error"	indicates UPC not properly configured
	-400, "Query error"	indicates query aborted

Query Example SYST:ERR?
-102, "Command error: Syntax error."

Query Format **SYSTem:ERRor:ALL?**
Description Returns all available error messages as a of error numbers and clears the error message queue.

Returned Data Format TOTAL_ERRORS ,ERRORS,CODE(INDEX),DESCRIPTION(INDEX),
CODE(INDEX+1), DESCRIPTION(INDEX+1),..., CODE(INDEX+N),
DESCRIPTION(INDEX+N),...

Query Example SYST:ERR:ALL?
0,0
SYST:ERR:ALL?
2,2,-102, "Command error: Syntax error. Webpage
interface.;2022/10/12 18:23:37",-102, "Command error: Syntax error.
Webpage interface.+2022/10/12 18:23:50"

Command Syntax **SYSTem:ERRor:ALL:CLEAR**
Description This command clears the error message queue.
Parameters None
Parameter Format n/a
Example SYST:ERR:ALL:CLEAR

<p>Command Syntax Description</p>	<p>SYSTem:ERROr:ALL:NOCLEAR? < Optional: Index> Returns all available error messages as a single unterminated string but does not clear the error message queue.</p>
<p>Returned Data Format</p>	<p><nr1>,<nr1>,<nr1>,<nr1> Format of response: YYYY/MM/DD,HH:MM::SS,S.NS,TOTAL_ERRORS,INDEX,ERRORS,CODE (INDEX),DESCRIPTION(INDEX),CODE(INDEX+1),DESCRIPTION(INDEX+1),...,CODE(INDEX+N),DESCRIPTION(INDEX+N),...</p> <p>Response Legend: YYYY/MM/DD,HH:MM::SS,S.NS is the timestamp of the latest error pushed to the queue. S is absolute seconds and NS absolute nanoseconds. TOTAL_ERRORS are the total errors in the queue. INDEX is 1 by default if not passed as optional argument. ERRORS is the total errors returned in the response. As there may be too many errors the response may return a few of them starting from the INDEX. The INDEX is useful to navigate the queue. CODE is the error code and DESCRIPTION the description.</p>
<p>Query Example</p>	<p>SYST:ERR:ALL:NOCLEAR? 2018/05/29,14:29:53,1207438.903668873,0,1,0 <u>For no errors:</u> >SYSTem:ERROr:ALL:NOCLEAR? 2022/10/12,18:17:01,122450.794695832,0,1,0 <u>Two errors in the queue:</u> >SYSTem:ERROr:ALL:NOCLEAR? 2022/10/12,18:17:19,122467.903705666,2,1,2,-102,"Command error: Syntax error. Webpage interface.;"2022/10/12 18:17:18",-102,"Command error: Syntax error. Webpage interface.;"2022/10/12 18:17:19" >SYSTem:ERROr:ALL:NOCLEAR? 2 2022/10/12,18:17:19,122467.903705666,2,2,1,-102,"Command error: Syntax error. Webpage interface.;"2022/10/12 18:17:19"</p>
<p>Command Syntax Description</p>	<p>SYSTem:ERROr:POE This command sets the Power on Error reporting mode. Returns status of Power on Error setting as 1 (enabled) or 0 (disabled).</p>
<p>Parameters</p>	<p>< 0 OFF 1 ON ></p>
<p>Parameter Format</p>	<p></p>
<p>Example</p>	<p>SYST:ERR:POE ON</p>
<p>Query Format</p>	<p>SYSTem:ERROr:POE?</p>
<p>Returned Data Format</p>	<p></p>
<p>Query Example</p>	<p>SYST:ERR:POE? 1</p>

8.9.2 System Information Commands

Command Syntax	SYSTem:BEEP
Description	This command generates an audible beep at the front panel of the power source.
Parameters	None
Parameter Format	n/a
Example	SYST:BEEP
Query Format	SYSTem:FW:FRONTPANEL:VERsion?
Description	Returns the firmware revision for the front panel processor.
Returned Data Format	<cr>
Query Example	SYST:FW:FRONTPANEL:VER? 2.0.0
Query Format	SYSTem:FW:FRONTPANEL:APPS:VERsion?
Description	Returns the firmware revision for the front panel application program.
Returned Data Format	<cr>
Query Example	SYST:FW:FRONTPANEL:APPS:VER? 2.0.0
Query Format	SYSTem:FW:IO:VERsion?
Description	Returns the firmware revision for the Auxiliary I/O board processor on ADF-xA version power sources.
Returned Data Format	<cr>
Query Example	SYST:FW:IO? 1.0.4
Query Format	SYSTem:FW:POWER:VERsion?
Description	Returns the revision number of the power source's power stages.
Returned Data Format	<nr2>-<nr2>
Query Example	SYST:FW:POWER:VER? 81.0.0-77.1.0
Query Format	SYSTem:LANGuage:CATalog?
Description	Returns list of available languages that can be selected for front panel operation.
Returned Data Format	<cr>
Query Example	SYST:LANG? english, chinese

Query Format	SYSTem:LXI:FEATures?
Description	Returns string listing supported LXI features.
Returned Data Format	<cr>
Query Example	SYST:LXI:FEAT? None
Query Format	SYSTem:LXI:VERSion?
Description	Returns LXI revision compliance version number.
Returned Data Format	<cr>
Query Example	SYST:LXI:VERSION? LXI Core 2011
Query Format	SYSTem:MODE?
Description	Returns LOCAL (0) or REMOTE (1) front panel status. Use IEEE 488.2 command commands *LLO to lock front panel and *GTL to release front panel operation.
Returned Data Format	
Query Example	SYST:MODE? 1
Query Format	SYSTem:SERIALNUM?
Description	Returns the serial number of the power source. Same information can be queried with the *IDN? command
Returned Data Format	<nr1>
Query Example	SYST:HWREV? 0
Query Format	SYSTem:TIME?
Description	Returns real time clock date and time. Note: Since both date and time are returned, there is no SYSTem:DATE?
Returned Data Format	<mm/dd/yy hh:mm:ss:mm
Query Example	SYSTem:TIME? 29/05/2018 14:40:57

<p>Query Format Description Returned Data Format Query Example</p>	<p>SYSTem:TIME:SOURce? Queries source of date and time information. <cr> SYST:TIME:SOUR? NTP Note: NTP stands for “Network Time Protocol”. A protocol built on top of TCP/IP that assures accurate local timekeeping with reference to radio, atomic or other clocks located on the Internet. This protocol is capable of synchronizing distributed clocks within milliseconds over long time periods. It is defined in STD 12, RFC 1119 (RFC = Request for comment. RFCs are used by the Internet Engineering Task Force (IETF) and other standards bodies.</p>
<p>Query Format Description Returned Data Format Query Example</p>	<p>SYSTem:TIME:UTC? Returns the UTC time, independent of the zone. DD/MM/YYYY HH:MM:SS SYST:TIME:UTC? 29/05/2019 14:40:57</p>
<p>Command Syntax Description Example Query Format Description Returned Data Format Query Example</p>	<p>SYSTem:TIME:ZONE <ZONE> Set the zone, allowed values are GMT+/-X. SYST:TIME:ZONE GMT-7 SYSTem:TIME:ZONE? Returns the current time zone setting, normally GMT+/-X <cr> SYST:TIME:ZONE? GMT-7</p>
<p>Query Format Description Returned Data</p>	<p>SYSTem:TIME:ZONE:CATalog? Returns the available zones. GMT-12,GMT-11,GMT-10,GMT-9,GMT-8,GMT-7,GMT-6,GMT-5,GMT-4, GMT-3, GMT-2,GMT-1,GMT+0,GMT+1,GMT+2,GMT+3,GMT+4,GMT+5, GMT+6,GMT+7,GMT+8,GMT+9,GMT+10,GMT+11,GMT+12,GMT+13, GMT+14</p>
<p>Command Syntax Description Parameters Example Query Format Description Returned Data</p>	<p>SYSTem:TIME:ZONE:LEAP <0 OFF 1 ON> Enables or Disables Leap Second mode. 1 or ON to consider leap seconds, otherwise 0 or OFF SYST:TIME:LEAP ON SYSTem:TIME:ZONE:LEAP? Returns 1 if it considers leap seconds, otherwise 0. 1 = Leap seconds considered, 0 = Leap seconds ignored</p>

Command Syntax	SYSTem:TIME:SOURce < RTC NTP >
Description	Set the time source, RTC is the local real time clock of the front panel. NTP is internet time protocol. NTP requires internet connection. If NTP is used with internet connection then the RTC is updated every time the NTP synchronizes.
Parameters	< RTC NTP >
Example	SYST:TIME:SOUR NTP
Query Format	SYSTem:TIME:SOURce:CATalog?
Description	Returns the available time source options, NTP or RTC.
Returned Data	NTP, RTC
Query Format	SYSTem:TIME:SOURce:NTP:SERVer?
Description	Returns “pool.ntp.org” This is the server that uses the unit NTP service.
Returned Data	pool.ntp.org
Command Syntax	SYSTem:TIME:SOURce:NTP:SYNC <OPTIONAL: SERVER>
Description	Forces an NTP sync. If the argument is not passed then it uses “pool.ntp.org”. Any IP/domain that runs a NTP server can be used. Alternative commons servers are “time.windows.com” or “time.nist.gov”.
Parameters	< time server domain >
Example	SYST:TIME:SOUR:NTP:SYNC
Command Syntax	SYSTem:TIME:SOURce:NTP:REStart
Description	Restarts the NTP service
Parameters	none
Example	SYST:TIME:SOUR:NTP:REST
Query Format	SYSTem:VERSion?
Description	Returns SCPI standard revision version.
Returned Data Format	<nr2>
Query Example	SYST:VERS? 1992.0
Query Format	SYSTem:XFMRRATIO?
Description	Returns the transformer option (T Option) voltage ratio. If no transformer option is installed and configured, this query will return a value of 0.000. See also the [SOURce:]COUPLing command.
Returned Data Format	<nr2>
Query Example	SYSTem:XFMRRATIO? 1.3333

8.9.3 System Interface Soft Key Preset Commands

These commands allow programming of the output programming preset soft key values for the front panel user interface of the power source. The same can be accomplished by the user from the front panel. Using a program to set these value can ensure they are always set to a known value if this is important for operator use of the power source in a specific test situation.

8.9.3.1 Preset Syntax

The syntax for all these commands is very similar. Prefix is always "SYSTem:INTERFace:PRESET:" followed by the parameter. Available soft key preset parameters are:

- VOLTage[:AC]
- FREQuency
- PHASe
- CURRent:LIMit
- POWEr:LIMit
- KVA:LIMit

To program or query a specific soft key number (1 ~ 5), append "SK#" to the command where # is a value from 1 through 5 for soft key 1 through 5. (Top soft key =1, bottom soft key = 5).

8.9.3.2 Command parameters

Available softkey parameters are:

- MIN MIN is the preset value for the min allowable setting based on the power source model
- MAX MAX is the the preset value for the max allowable setting based on the power source model
- DEF DEF sets the preset value to factory default
- Value A <nr1> value between MIN and MAX may be specified instead.

Up to five sets of parameters can be appended to these commands to program more than one soft key for the same parameter setting with a single command string.

Example:

```
SYST:INTERF:PRESET:VOLT MAX, MIN, 108, 140
```

Programs the voltage AC soft keys as follows:

```
SK1 = MAX or 300, SK2 = MIN or 0, SK3 = 108, SK4 = 140.
```

8.9.3.3 Preset Commands Listing

The following lists shows all available soft key preset programming commands.

Voltage AC

SYSTem:INTERFace:PRESET:VOLTage[:AC] <REQ: MIN|MAX|DEF|Value, OPT: MIN|MAX|DEF|Value, OPT: MIN|MAX|DEF|Value, OPT: MIN|MAX|DEF|Value, OPT: MIN|MAX|DEF|Value>

SYSTem:INTERFace:PRESET:VOLTage[:AC]? <OPT: ALL|DEF> <OPT: ALL|DEF>

SYSTem:INTERFace:PRESET:VOLTage[:AC]:SK# <REQ: MIN|MAX|DEF|Value>

SYSTem:INTERFace:PRESET:VOLTage[:AC]:SK#?

Frequency

SYSTem:INTERFace:PRESET:FREQuency <REQ: MIN|MAX|DEF|Value, OPT: MIN|MAX|DEF|Value, OPT: MIN|MAX|DEF|Value, OPT: MIN|MAX|DEF|Value, OPT: MIN|MAX|DEF|Value>

SYSTem:INTERFace:PRESET:FREQuency? <OPT: ALL|DEF> <OPT: ALL|DEF>

SYSTem:INTERFace:PRESET:FREQuency:SK# <REQ: MIN|MAX|DEF|Value>

SYSTem:INTERFace:PRESET:FREQuency:SK#?

Current Limit

SYSTem:INTERFace:PRESET:CURRent:LIMit <REQ: MIN|MAX|DEF|Value, OPT: MIN|MAX|DEF|Value, OPT: MIN|MAX|DEF|Value, OPT: MIN|MAX|DEF|Value, OPT: MIN|MAX|DEF|Value>

SYSTem:INTERFace:PRESET:CURRent:LIMit? <OPT: ALL|DEF> <OPT: ALL|DEF>

SYSTem:INTERFace:PRESET:CURRent:LIMit:SK# <REQ: MIN|MAX|DEF|Value>

SYSTem:INTERFace:PRESET:CURRent:LIMit:SK#?

Power Limit

SYSTem:INTERFace:PRESET:POWer:LIMit <REQ: MIN|MAX|DEF|Value, OPT: MIN|MAX|DEF|Value, OPT: MIN|MAX|DEF|Value, OPT: MIN|MAX|DEF|Value, OPT: MIN|MAX|DEF|Value>

SYSTem:INTERFace:PRESET:POWer:LIMit? <OPT: ALL|DEF> <OPT: ALL|DEF>

SYSTem:INTERFace:PRESET:POWer:LIMit:SK# <REQ: MIN|MAX|DEF|Value>

SYSTem:INTERFace:PRESET:POWer:LIMit:SK#?

Apparent Power Limit

SYSTem:INTERFace:PRESET:KVA:LIMit <REQ: MIN|MAX|DEF|Value, OPT: MIN|MAX|DEF|Value, OPT: MIN|MAX|DEF|Value, OPT: MIN|MAX|DEF|Value, OPT: MIN|MAX|DEF|Value>

SYSTem:INTERFace:PRESET:KVA:LIMit? <OPT: ALL|DEF> <OPT: ALL|DEF>

SYSTem:INTERFace:PRESET:KVA:LIMit:SK# <REQ: MIN|MAX|DEF|Value>

SYSTem:INTERFace:PRESET:KVA:LIMit:SK#?

Examples of programming User Preset Soft keys:

SYST:INTERF:PRESET:VOLT:AC 115.000,230.000,300.000,MAX

SYST:INTERF:PRESET:FREQ 50.000,60.000,400.000,800.000,1200.000

SYST:INTERF:PRESET:CURR:LIM MAX,15.000,5.000

SYST:INTERF:PRESET:POW:LIM MAX,4.000,2.000,1.000

SYST:INTERF:PRESET:KVA:LIM MAX,4.000,2.000,1.000

Examples of programming a specific User Preset Soft key:

SYST:INTERF:PRESET:VOLT:AC:SK1 115

Examples of querying programming User Preset Soft key settings:

SYSTEM:INTERF:PRESET:VOLT:AC? -> 115.000,230.000,300.000,MAX

SYSTEM:INTERF:PRESET:FREQ? -> 50.000,60.000,400.000,800.000,1200.000

SYSTEM:INTERF:PRESET:CURR:LIM? -> MAX,15.000,5.000

SYSTEM:INTERF:PRESET:POW:LIM? -> MAX,4.000,2.000,1.000

SYSTEM:INTERF:PRESET:KVA:LIM? -> MAX,4.000,2.000,1.000

Example of querying programming User Preset for a specific soft key number:

SYST:INTERF:PRESET:VOLT:AC:SK1? -> 115.000

8.9.3.4 Other Front Panel Function Commands

These commands are equivalent to some of the functions available in the LOCAL INTERFACE settings.

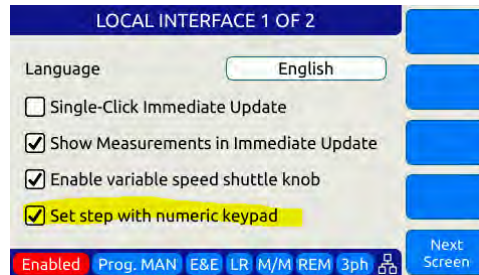

Beeper Volume - Range is 0 through 10:

SYSTem:INTERFace:VOLUme <VOLUME>

SYSTem:INTERFace:VOLUme?

LCD Brightness - Range is 0 through 10:

SYSTem:INTERFace:LCD[:BRIGHTness] <BRIGHTNESS>

SYSTem:INTERFace:LCD[:BRIGHTness]?

Keypad Backlit Brightness - Range is 0 through 10:

SYSTem:INTERFace:KEYS:BRIGHTness <BRIGHTNESS>

SYSTem:INTERFace:KEYS:BRIGHTness?

Key Press Sounds:

SYSTem:INTERFace:KEYS:SOUNDS <ON|OFF>

SYSTem:INTERFace:KEYS:SOUNDS?

Set Resolution Step Size with the numeric keypad

SYSTem:INTERFace:KEYS:STEPset <ON|OFF>

SYSTem:INTERFace:KEYS:STEPset?

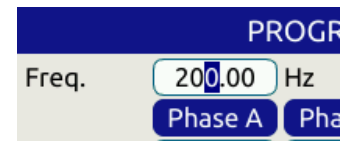

Single Click Update Mode:

SYSTem:INTERFace:IMMEDIATEupdate:SINGLEclick <ON|OFF>

SYSTem:INTERFace:IMMEDIATEupdate:SINGLEclick?

Show Measurements in Immediate Update:

SYSTem:INTERFace:IMMEDIATEupdate:SHOWMEASurements <ON|OFF>

SYSTem:INTERFace:IMMEDIATEupdate:SHOWMEASurements?

Variable Shuttle Knob Speed - Range is 0 through 10:

SYSTem:INTERFace:KNOB:SPEED <SPEED>

SYSTem:INTERFace:KNOB:SPEED?

8.9.4 System Configuration Commands

Query Format	SYSTem:MAXKVA?
Description	Returns maximum available kVA output capability of the power source. Example for 3150ADF model = 15.000
Returned Data Format	<nr2>
Query Example	SYST:MAXKVA? 15.000
Query Format	SYSTem:MAXCURREnt?
Description	Returns maximum available RMS output current capability of the power source. Example for 3150ADF model = 41.6667.
Returned Data Format	<nr2>
Query Example	SYST:MAXCURR? 41.6667
Query Format	SYSTem:MAXVOLTage?
Description	Returns maximum available RMS voltage output capability of the power source. Example for 3150ADF model = 300.
Returned Data Format	<nr1>
Query Example	SYST:MAXVOLT? 300
Command Syntax	SYSTem:COMPAtible
Description	Sets Pacific Power Source UPC controller compatibility mode. This mode allows use of the power source with legacy software.
Parameters	< 0 DISABLE 1 UPC >
Parameter Format	
Example	SYST:COMP UPC
Query Format	SYSTem:COMPAtible?
Returned Data Format	
Query Example	SYST:COMP? 1
Query Format	SYSTem:HWREVisIon?
Description	Returns the hardware revision letter of the power source
Returned Data Format	<cr>
Query Example	SYST:HWREV? A

Command Syntax	SYSTem:LANGuage
Description	Sets Pacific Power Source UPC controller compatibility mode. This mode allows use of the power source with legacy software.
Parameters	< english Chinese > Note: Refer to SYSTem:LANGuage:CATalog? query command for list of supported languages.
Parameter Format	<cr>
Example	SYST:LANG chinese
Query Format	SYSTem:LANGuage?
Returned Data Format	
Query Example	SYST:LANG? chinese

8.9.5 Parallel System Commands

Command Syntax	SYSTem:DISCOVERY
Description	Initiates discovery of the number of paralleled power sources
Parameters	None
Parameter Format	n/a
Example	SYST:DISCOVERY
Query Format	SYSTem:PARALLELUNITS?
Description	Returns the number of power sources found.
Returned Data Format	<nr1>
Query Example	SYST:PARALLELUNITS? 1
Command Syntax	SYSTem:PARALLELUNITS:EXPEcted
Description	Sets the number of power sources that should be connected to the system interface bus.
Parameters	1 – 200
Parameter Format	<nr1>
Example	SYST:PARALLELUNITS:EXPE 4
Query Format	SYSTem:PARALLELUNITS:EXPEcted?
Returned Data Format	<nr1>
Query Example	SYST:PARALLELUNITS:EXPE? 4

Multi-Unit System Configuration Command Examples:

```

30kVA Parallel ADF System
SOURCE:SERIES 0
SYSTem:SERIESUNITS? = 1
SYSTem:PARALLELUNITS? = 2
SYSTem:CONNECTEDUNITS? = 2
    
```

```

60kVA Parallel ADF System
SOURCE:SERIES 0
SYSTem:SERIESUNITS? = 1
SYSTem:PARALLELUNITS? = 4
SYSTem:CONNECTEDUNITS? = 4
    
```

8.9.6 System Sanitization Commands

Query Format	SYSTem:SANITIZE:CODE?
Description	Returns sanitization password string.
Returned Data Format	<nr1>
Query Example	SYSTem:SANITIZE:CODE? 0659
Command Syntax	SYSTem:SANITIZE <code>
Description	Erases all user data stored in non-volatile memory settings including settings and custom waveforms if required. The code is obtained by the query command above.
Parameters	None
Parameter Format	n/a
Example	SYST:SANITIZE 0659

8.9.7 Communication LAN Commands

Command Syntax	SYSTem:COMMunicate:LAN[:ENABLE]
Description	This command turns remote control via LAN on or off. To control the power source through its LAN interface, this state has to on (1).
Parameters	< 0 OFF 1 ON >
Parameter Format	
Example	SYST:COMM:LAN ON
Query Format	SYSTem:COMMunicate:LAN[:ENABLE]?
Returned Data Format	
Query Example	SYST:COMM:LAN? 1
Query Format	SYSTem:COMMunicate:LAN:STATus?
Description	This command returns all LAN settings in a single comma delimited string of values.
Returned Data Format	<cr>, <cr>,.....,<cr>,<cr>
Query Example	SYSTem:COMMunicate:LAN:STATus? 192.168.14.22,255.255.254.0,192.168.15.254,192.168.15.208,ADF-106378937,ADF-106378889,0,1,0

<p>Command Syntax Description</p>	<p>SYSTem:COMMunicate:LAN:DHCP[:ENABLE] This command turns DHCP mode for the LAN interface on or off. DHCP = Dynamic Host Configuration Protocol". This protocol automatically provides an IP address and other related information such as the subnet mask and default gateway. When turned off, a static IP address must be assigned by the user instead.</p>
<p>Parameters Parameter Format Example Query Format Returned Data Format Query Example</p>	<p>< 0 OFF 1 ON > SYST:COMM:LAN:DHCP ON SYSTem:COMMunicate:LAN:DHCP[:ENABLE]? SYST:COMM:LAN:DHCP? 1</p>
<p>Command Syntax Description</p>	<p>SYSTem:COMMunicate:LAN:DHCP:RENEW This command renews the lease of an IP address assigned through the DHCP protocol. This may be necessary if the power source has not been used in a while and its IP address lease has expired. If not renewed, a different IP address may be assigned.</p>
<p>Parameters Parameter Format Example</p>	<p>None n/a SYST:COMM:LAN:DHCP:RENEW</p>
<p>Command Syntax Description</p>	<p>SYSTem:COMMunicate:LAN:ADDress This command is used to assign a fixed IP address to the power source for LAN communication.</p>
<p>Parameters Parameter Format Example Query Format Returned Data Format Query Example</p>	<p>ddd.ddd.ddd.ddd (four octets ranging in value from 0 to 255 representing one 16 bit unsigned integer value each. <cr> SYST:COMM:LAN:ADD 132.18.21.105 SYSTem:COMMunicate:LAN:ADDress? <cr> SYST:COMM:LAN:ADD? 132.18.21.105</p>
<p>Query Format Description</p>	<p>SYSTem:COMMunicate:LAN:MACaddress? This query returns the MAC address of the connected power source. The Media Access Control address or MAC address is also referred to as physical address as it is fix and unique to any device on the network. The MAC address for the power source is also printed on the rear panel near the LAN interface connector. It consists of 8 sets of hexadecimal 16 bit unsigned integer values.</p>
<p>Returned Data Format Query Example</p>	<p><cr> SYST:COMM:LAN:MAC? 3A.3F.00.4C.DE.AA.39.8F</p>

Query Format	SYSTem:COMMunicate:LAN:VISA?
Description	Queries the VISA resource name / address string
Returned Data Format	<cr>
Query Example	TCPIP::ADF-1003::INSTR
Command Syntax	SYSTem:COMMunicate:LAN:APPLY
Description	Applies all changes send using the COMM:LAN commands.
Parameters	None
Parameter Format	n/a
Example	SYST:COMM:LAN:APP
Command Syntax	SYSTem:COMMunicate:LAN:MASK
Description	This command sets the IP mark value for the power source LAN interface. It is normally obtained through DCHP. If a static IP must be used, the mask has to set as well.
Parameters	ddd.ddd.ddd.ddd (four octets ranging in value from 0 to 255 representing one 16 bit unsigned integer value each.
Parameter Format	<cr>
Example	SYST:COMM:LAN:MASK 255.255.254.0
Query Format	SYSTem:COMMunicate:LAN:MASK?
Returned Data Format	<cr>
Query Example	SYST:COMM:LAN:MASK? 255.255.254.0
Command Syntax	SYSTem:COMMunicate:LAN:DNSaddress
Description	Sets the IP address for the DNS server
Parameters	ddd.ddd.ddd.ddd (four octets ranging in value from 0 to 255 representing one 16 bit unsigned integer value each.
Parameter Format	<cr>
Example	SYST:COMM:LAN:DNS 132.18.21.208
Query Format	SYSTem:COMMunicate:LAN:DNSaddress?
Returned Data Format	<cr>
Query Example	SYST:COMM:LAN:DNS? 132.18.21.208
Command Syntax	SYSTem:COMMunicate:LAN:GWAddress
Parameters	Sets the IP address for the Network Gateway. A default gateway is the node on the computer network that the network software uses when an IP address does not match any other routes in the routing table
Parameter Format	<cr>
Example	SYST:COMM:LAN:GWAD 132.18.21.254
Query Format	SYSTem:COMMunicate:LAN:GWAddress?
Returned Data Format	<cr>
Query Example	SYST:COMM:LAN:GWAD? 132.18.21.254

<p>Command Syntax Description</p>	<p>SYSTem:COMMunicate:LAN:HOST:CONFigured Sets the network host address. The host address is the portion of the address used to identify hosts (any device requiring a Network Interface Card, such as a PC or networked printer) on the network. The network ID, by contrast, is the portion of the address that refers to the network itself.</p>
<p>Parameters</p>	<p>ddd.ddd.ddd.ddd (four octets ranging in value from 0 to 255 representing one 16 bit unsigned integer value each.</p>
<p>Parameter Format</p>	<p><cr></p>
<p>Example</p>	<p>SYST:COMM:LAN:HOST 132.18.21.0</p>
<p>Query Format</p>	<p>SYSTem:COMMunicate:LAN:HOST:CONFigured?</p>
<p>Returned Data Format</p>	<p><cr></p>
<p>Query Example</p>	<p>SYST:COMM:LAN:HOST:CONF? 132.18.21.0</p>
<p>Command Syntax Description</p>	<p>SYSTem:COMMunicate:LAN:PASSword Assign a password to enable or disable LAN communications. This feature allows the owner/operator to disable or enable remote LAN access or limit functionality over LAN. Note: There is no query format for this command so the password code cannot be queried back.</p>
<p>Parameters</p>	<p>Four digit passcode</p>
<p>Parameter Format</p>	<p><nr1?></p>
<p>Example</p>	<p>SYST:COMM:LAN:PASS 1234</p>
<p>Command Syntax Description</p>	<p>SYSTem:COMMunicate:LAN:PORT Sets LAN interface port address. For SCPI message communications, the standard port number is 5025.</p>
<p>Parameters</p>	<p>1024–49151, default = 5025</p>
<p>Parameter Format</p>	<p><nr1></p>
<p>Example</p>	<p>SYST:COMM:LAN:PORT 5025</p>
<p>Query Format</p>	<p>SYSTem:COMMunicate:LAN:PORT?</p>
<p>Returned Data Format</p>	<p><nr1></p>
<p>Query Example</p>	<p>SYST:COMM:LAN:PORT? 5025</p>
<p>Command Syntax Description</p>	<p>SYSTem:COMMunicate:LAN:PORT:TELNET Sets the port address for TELNET protocol</p>
<p>Parameters</p>	<p>1024–49151, default = 5024</p>
<p>Parameter Format</p>	<p><nr1></p>
<p>Example</p>	<p>SYST:COMM:LAN:PORT:TELNET 5024</p>
<p>Query Format</p>	<p>SYSTem:COMMunicate:LAN:PORT:TELNET?</p>
<p>Returned Data Format</p>	<p><nr1></p>
<p>Query Example</p>	<p>SYST:COMM:LAN:PORT:TELNET? 5024</p>

8.9.8 Communication Serial Port Commands

Command Syntax	SYSTem:COMMunicate:SERial[:ENABLE]
Description	This command is used to turn the RS232 serial interface on or off. To use this interface for remote control of the power source, it must be set to ON.
Parameters	< 0 OFF 1 ON >
Parameter Format	
Example	SYST:COMM:SER ON
Query Format	SYSTem:COMMunicate:SERial[:ENABLE]?
Returned Data Format	
Query Example	SYST:COMM:SER? 1
Query Format	SYSTem:COMMunicate:SERial:STATus?
Description	This command returns all serial port settings
Returned Data Format	Baud rate, status,data bits, stop bits, parity, flow control
Query Example	SYST:COMM:SER:STAT? 921600,0,8,1,0,0
Command Syntax	SYSTem:COMMunicate:SERial:BAUD
Description	This command sets the baud rate for the serial port.
Parameters	< 1200 1800 2400 4800 9600 14400 19200 38400 57600 62500 115200 230400 460800 500000 576000 921600 >
Parameter Format	<nr1>
Example	SYST:COMM:SER:BAUD 115200
Query Format	SYSTem:COMMunicate:SERial:BAUD?
Returned Data Format	<cr1>
Query Example	SYST:COMM:SER:BAUD? 115200
Command Syntax	SYSTem:COMMunicate:SERial:PARity
Description	This command sets the parity for the serial port.
Parameters	< 0 NONE 1 OFF 2 EVEN >
Parameter Format	<nr1>
Example	SYST:COMM:SERial:PAR NONE
Query Format	SYSTem:COMMunicate:SERial:PARity?
Returned Data Format	<nr1>
Query Example	SYST:COMM:SER:PAR? 0

Command Syntax	SYSTem:COMMunicate:SERial:BITS
Description	This command sets the number of data bits used for serial communications. Available settings are 7 or 8
Parameters	< 7 8 >
Parameter Format	<nr1>
Example	SYST:COMM:SER:BITS 8
Query Format	SYSTem:COMMunicate:SERial:BITS?
Returned Data Format	<nr1>
Query Example	SYST:COMM:SER:BITS? 8
Command Syntax	SYSTem:COMMunicate:SERial:SBITs
Description	This command sets the number of stop bits used for serial communications. Available settings are 1 or 2.
Parameters	< 1 2 >
Parameter Format	<nr1>
Example	SYST:COMM:SER:SBIT 2
Query Format	SYSTem:COMMunicate:SERial:SBITs?
Returned Data Format	<nr1>
Query Example	SYST:COMM:SER:SBIT? 2
Command Syntax	SYSTem:COMMunicate:SERial:FLOWcontrol
Description	This command sets the method of handshaking used for serial communications. Available settings are Xon/Xoff or Hardware handshake.
Parameters	< 0 OFF 1 ON >
Parameter Format	
Example	SYST:COMM:SER:FLOW ON
Query Format	SYSTem:COMMunicate:SERial:FLOWcontrol?
Returned Data Format	<nr1>
Query Example	SYST:COMM:SER:FLOW? 1

8.9.9 Communication USB Commands

Command Syntax	SYSTem:COMMunicate:USB:VIRTualport[:ENABLE]
Description	This command enables USB device control using virtual comm driver.
Parameters	< 0 OFF 1 ON >
Parameter Format	
Example	SYST:COMM:USB:VIRT ON
Query Format	SYSTem:COMMunicate:USB:VIRTualport[:ENABLE]?
Returned Data Format	
Query Example	SYST:COMM:USB:VIRT? 1

Command Syntax	SYSTem:COMMunicate:USB:LAN[:ENABLE]
Description	Enables access to embedded webserver using virtual IP Address through USB interface.
Parameters	< 0 OFF 1 ON >
Parameter Format	
Example	SYST:COMM:USB:ETH ON
Query Format	SYSTem:COMMunicate:USB:LAN[:ENABLE]?
Returned Data Format	
Query Example	SYST:COMM:USB:LAN? 1
Command Syntax	SYSTem:COMMunicate:USB:LAN:ADDRESS
Description	Sets the embedded webserver virtual IP Address for USB interface.
Parameters	< 0 OFF 1 ON >
Parameter Format	
Example	SYST:COMM:USB:LAN ON
Query Format	SYSTem:COMMunicate:USB:LAN:ADD?
Returned Data Format	
Query Example	SYST:COMM:USB:LAN:ADD? 192.168.123.1
Command Syntax	SYSTem:COMMunicate:USB:LAN:APPLY
Description	Applies IP settings for Virtual USB Lan interface.
Parameters	None
Parameter Format	N/A
Example	SYST:COMM:USB:LAN:APP
Command Syntax	SYSTem:COMMunicate:USB:LAN:MASK
Description	Sets the embedded webserver virtual IP Mask Address for USB interface.
Parameters	IP Mask
Parameter Format	<cr>
Example	SYST:COMM:USB:LAN ON
Query Format	SYSTem:COMMunicate:USB:LAN:MASK?
Returned Data Format	<cr>
Query Example	SYST:COMM:USB:LAN:MASK? 255.255.255.0

8.9.10 Communication GPIB Commands

Command Syntax	SYSTem:COMMunicate:GPIB:ADdRes <nr1>
Description	This command sets the GPIB address.
Parameters	< 1..30 >
Parameter Format	<nr1>
Example	SYST:COMM:GPIB:ADD 5
Query Format	SYSTem:COMMunicate:GPIB:ADdRes?
Returned Data Format	<nr1>
Query Example	SYST:COMM:GPIB:ADD? 5

Command Syntax	SYSTem:COMMunicate:GPIB:ENABle
Description	Enables access to embedded webserver using virtual IP Address through USB interface.
Parameters	< 0 OFF 1 ON >
Parameter Format	
Example	SYST:COMM:GPIB:ENAB 1
Query Format	SYSTem:COMMunicate:GPIB:ENABle?
Returned Data Format	
Query Example	SYST:COMM:GPIB:ENAB? 1

Command Syntax	SYSTem:COMMunicate:GPIB:BAUDrate
Description	Sets the internal serial link speed between the GPIB interface and the front panel processor. This setting is set to 921600 bps as a default and should only be changed to a lower setting if there is a problem with the GPIB interface not working reliably.
Parameters	< 1200 1800 2400 4800 9600 14400 19200 38400 57600 62500 115200 230400 460800 500000 576000 921600 >
Parameter Format	<nr1>
Example	SYST:COMM:GPIB:BAUD 921600
Query Format	SYSTem:COMMunicate:GPIB:BAUDrate?
Returned Data Format	<nr1>
Query Example	SYST:COMM:GPIB:BAUD? 921600

8.9.11 System Firmware Commands

Query Format	SYSTem:FW:POWER[:VERsion]?
Description	This command returns the firmware revision of the power converter DSP's. This information is for reference only.
Returned Data Format	<cr>-<cr>
Query Example	SYST:FW:POWER:VER? 81.0.0.RC8-77.1.0
Query Format	SYSTem:FW:FRONTPANEL:VERsion?
Description	This command returns the firmware revision of front panel controller processor. This information is for reference only.
Returned Data Format	<cr>
Query Example	SYST:FW:FRONTPANEL:VER? 2.0.0
Query Format	SYSTem:FW:FRONTPANEL:APPS:VERsion?
Description	This command returns the firmware revision of front panel controller user interface application. This information is for reference only. Note: This revision number is also returned as part of the *IDN? query response.
Returned Data Format	<cr>
Query Example	SYST:FW:FRONTPANEL:APPS:VER? 2.0.0
Query Format	SYSTem:HWREVision?
Description	This command returns the hardware revision (build) of the power source.
Returned Data Format	<nr2>
Query Example	SYST:HWREV? 0

8.9.12 System Remote Access Commands

Command Syntax	SYSTem:REMOte:ACCESS
Description	Sets remote access permission.
Parameters	<0 DISABLED 1 ENABLED>
Parameter Format	
Example	SYST:REM:ACCESS 1
Query Format	SYSTem:REMOte:ACCESS?
Returned Data Format	<cr>
Query Example	SYST:REM:ACCESS? 1
Command Syntax	SYSTem:REMOte:ACCESS:REQuest
Description	This commands results in a pop up dialog on the front panel display requesting the local user to ACCEPT. Confirms presence of a person at the location of the instrument.
Parameters	Alias name. (This argument is optional)
Parameter Format	<cr>
Example	SYSTem:REMOte:ACCESS:REQuest
Query Format	None
Command Syntax	SYSTem:REMOte:ACCESS:LOGIN
Description	This command uses a password as an argument to request access to the instrument. The password can be set on the front panel or using the SYSTem:REMOte:PASSword command
Parameters	Password
Parameter Format	<nr1>
Example	SYSTem:REMOte:ACCESS:LOGIN 1234
Query Format	None
Command Syntax	SYSTem:REMOte:ACCESS:MESSAge <cr>
Description	Allows a user specific message to be displayed at the bottom of the Access Control Browser dialog informing anyone requesting access whom to contact.
Parameters	User Message
Parameter Format	<cr>
Example	SYSTem:REMOte:ACCESS:MESS "Unit is used by John. Please contact 123456789."
Query Format	SYSTem:REMOte:ACCESS:MESSAge?
Returned Data Format	<cr>
Query Example	SYST:REM:ACCESS:MESS? "Unit is used by John. Please contact 123456789."

Command Syntax	SYSTem:REMote:ACCESS:MONItor
Description	Enables or disables remote access monitor mode only. ON by default for backward compatibility.
Parameters	< 0 OFF 1 ON >
Parameter Format	 or <cr>
Example	SYSTem:REMote:ACCESS:MONI ON
Query Format	SYSTem:REMote:ACCESS:MONItor?
Returned Data Format	
Query Example	SYST:REM:ACCESS:MONI? 1
Command Syntax	SYSTem:REMote:FTP:ENable
Description	Enable/disable the FTP service.
Parameters	<0 OFF 1 ON>
Parameter Format	
Example	SYST:REM:FTP:ENA 1
Query Format	SYSTem:REMote:FTP:ENable?
Returned Data Format	
Query Example	SYST:REM:FTP:ENA? 1
Command Syntax	SYSTem:REMote:FTP:PASSword
Description	Sets remote FTP access permission password.
Parameters	password
Parameter Format	<cr>
Example	SYST:REM:FTP:PASS temporal
Query Format	SYSTem:REMote:FTP:PASSword?
Returned Data Format	<cr>
Query Example	SYST:REM:FTP:PASS? temporal
Command Syntax	SYSTem:REMote:SMB:ENable
Description	Enable/disable the samba service.
Parameters	<0 OFF 1 ON>
Parameter Format	
Example	SYST:REM:FTP:ENA 1
Query Format	SYSTem:REMote:SMB:ENable?
Returned Data Format	
Query Example	SYST:REM:SMB:ENA? temporal

Command Syntax	SYSTem:REMote:SMB:PASSword
Description	Sets remote Samba services access permission password
Parameters	password
Parameter Format	<cr>
Example	SYST:REM:SMB:PASS temporal
Query Format	SYSTem:REMote:SMB:PASSword?
Returned Data Format	<cr>
Query Example	SYST:REM:SMB:PASS? temporal

8.9.13 Miscellaneous System Commands

Command Syntax	SYSTem:BEEP
Description	This command generates a beep from the front panel speaker. May be used in ATE programs to get operator's attention. Make sure the beep volume is not set to 0. See SYSTem:INTERFace:VOLume cmd.
Returned Data Format	<cr>,...,<cr>
Query Format	None
Query Format	SYSTem:MEMory:CATalog?
Description	This command returns the available memory types catalog.
Returned Data Format	<cr>,...,<cr>
Query Example	SYST:MEM:CAT? INTERNAL, RAM
Command Syntax	SYSTem:MEMory:REMove
Description	This command unmounts system memory.
Returned Data Format	<cr>,...,<cr>
Query Format	None
Command Syntax	SYSTem:DELeTe <PATH>
Description	This command deletes a file or folder. The path or filename can be between double quotation marks or not.
Parameters	PATH or FILE
Parameter Format	<cr>
Example	SYST:DEL internal/program/program_1.xml SYST:DEL "internal/program/program_1.xml" SYST:DEL temporal/program/program_1.xml SYST:DEL "temporal/program/program_1.xml"
Query Format	none
Query Format	SYSTem:FILE:TYPE? <MEM>
Description	This command returns the file type in numeric available memory types catalog.
Returned Data Format	<nr1>
Query Example	SYST:FILE:TYPE? RAM 0 SYST:FILE:TYPE? INTERNAL 0

Command Syntax	SYSTem:SCREENshot
Description	This command takes a screen shot of the LCD display. The LCD image is saved as a “.png” format image file to folder “internal/screenshots”
Parameters	None
Parameter Format	N/A
Example	SYST:SCREEN
Query Format	none

8.9.14 System Import / Export Commands

These commands allow complete system configurations to be exported or imported.

Command Syntax	SYSTem:EXPOrt <OPT: CONFIGURATION, OPT: WAVEFORMS, OPT: PROGRAMS, OPT: SETPOINTS, OPT: [NAME, NAMEFILE]>
Description	Exports complete record of system configuration of the power source to a compressed file. If argument name is omitted it is stored in temporal/DATE—TIME.7z otherwise in temporal/NAMEFILE.7z. The others arguments indicate what is going to be exported, if none of them are passed all is going to be exported.
Parameters	<OPT: CONFIGURATION, OPT: WAVEFORMS, OPT: PROGRAMS, OPT: SETPOINTS, OPT: [NAME, NAMEFILE]>
Parameter Format	<cr>
Example	SYST:EXPORT SYST:EXPORT NAME,TEST SYST:EXPORT SETPOINTS,NAME,TEST2 SYST:EXPORT SETPOINTS, WAVEFORMS,NAME,TEST3
Command Syntax	SYSTem:IMPOrt <OPT: CONFIGURATION, OPT: WAVEFORMS, OPT: PROGRAMS, OPT: SETPOINTS, [NAME, NAMEFILE]>
Description	Imports complete system configuration records of the power source. The compressed file has to be in /temporal/NAMEFILE.7z. The other others arguments indicate what will be imported, if none of them are passed all is going to be imported.
Parameters	<OPT: CONFIGURATION, OPT: WAVEFORMS, OPT: PROGRAMS, OPT: SETPOINTS, [NAME, NAMEFILE]>
Parameter Format	<cr>
Example	SYST:IMPORT NAME,TEST

8.9.15 System Regional Setting Commands

These commands are used to set regional setting for Dates, Times and Decimal separators. They are relevant when exporting or importing CSV files for use in applications like MS Excel or MS Word.

These commands are used to set regional setting for Dates, Times and Decimal separators. They are relevant when exporting or importing CSV files for use in applications like MS Excel or MS Word.

Command: **SYSTem:REGion:DATEFormat <FORMAT>**

Sets the date display format as either **DD/MM/YYYY** (Asia) EU or **MM/DD/YYYY** (USA)

Example: SYST:REG:DATE DD/MM/YYYY

Query: **SYSTem:REGion:DATEFormat?**

Example: SYST:REG:DATE?
DD/MM/YYYY

Command: **SYSTem:REGion:DATEFormat:CATalog?**

Returns: MM/DD/YYYY,DD/MM/YYYY

Command: **SYSTem:REGion:DECImalsymbol <SEPARATOR>**

Sets the decimal separator to either a comma (Asia, EU) or a period (USA). Parameters are “.” Or “,”.

Example: SYST:REG:DECI “,”

Query: **SYSTem:REGion:DECImalsymbol?**

Returns decimal separator setting.

Examples SYST:REG:DATE?
,

8.9.16 Miscellaneous Remote Restart Commands

Command Syntax	SYSTem:COMMunicate:LXI:REStart
Description	Restarts the LXI interface.
Parameters	None
Parameter Format	n/a
Example	SYST:COMM:LXI:REST

Command Syntax	SYSTem:REMote:FTP:REStart
Description	Restarts the FTP Server.
Parameters	None
Parameter Format	n/a
Example	SYST:REM:FTP:REST

Command Syntax	SYSTem:REMOte:SMB:REStart
Description	Restarts the Samba Server.
Parameters	None
Parameter Format	n/a
Example	SYST:REM:SMB:REST
Command Syntax	SYSTem:RESTART
Description	Restarts the SPCI Processor.
Parameters	None
Parameter Format	n/a
Example	SYST:RESTART
Command Syntax	SYSTem:INTERFace:REStart
Description	Restarts the Display Processor.
Parameters	None
Parameter Format	n/a
Example	SYST:INTERF:REST

8.10 Auxiliary I/O System Commands

Commands specific to the auxiliary I/O functions are listed in this section.

8.10.1 System Analog & Digital IO Commands

```
SYSTem:AIO
  :INput[1 | 2 | 3 | .4][?]
    :CATalog?
    :GAIN[?]
      :DEFault?
      :MAXimum?
      :MINimum?
    : OFFSET[?]
      :DEFault?
      :MAXimum?
      :MINimum?
    :RANGe[?]
      :DEFault?
      :MAXimum?
      :MINimum?
    :UNITs?
    :VOLTage?
  :OUTput[1 | 2 | 3 | .4][?]
    :CATalog?
    :GAIN[?]
      :DEFault?
      :MAXimum?
      :MINimum?
    :OFFSET[?]
      :DEFault?
      :MAXimum?
      :MINimum?
    :RANGe[?]
      :DEFault?
      :MAXimum?
      :MINimum?
    :UNITs?
    :VOLTage?
```



```

SYSTem:DIO
  :INput[1 | 2 | 3 |.4][?]
    :FALLing[?]
    :FILtersize[?]
      :DEFault?
      :MAXimum?
      :MINimum?
    :RISing[?]
  :OUTput[1 | 2 | 3 |.4][?]
    :CATalog?
    :INVert[?]
    :STATe?
  :REMote
    :ENable[?]
    :INHibit[?]
  :STROBE
    :OUTPutstate[?]
    :SOURce[?]
    :TRANsient[?]

```

8.10.1.1 SYSTem:AIO:Input

Command Syntax	SYSTem:AIO:INput[n] <cr>
Description	Sets the ADF parameter to be controlled by the analog input.
Parameters	[CURR:LIM CURR:LIM1 CURR:LIM2 CURR:LIM3 FREQ KVA:LIM KVA:LIM1 KVA:LIM2 KVA:LIM3 OFF PHAS2 PHAS3 POW:LIM POW:LIM1 POW:LIM2 POW:LIM3 VOLT:AC VOLT:AC1 VOLT:AC2 VOLT:AC3 VOLT:DC VOLT:DC1 VOLT:DC2 VOLT:DC3] See the “SYSTem:AIO:INput:CATalog?” command response for a list of supported parameters.
Parameter Format	<cr>
Example	SYST:AIO:IN1 VOLTAGE
Query Format	SYSTem:AIO:INput[n]?
Returned Data Format	<cr>
Query Example	SYST:AIO:IN1? VOLTAGE
Query Format	SYSTem:AIO:INput:CATalog?
Description	Returns list of available analog inputs
Returned Data Format	<cr>
Query Example	SYST:AIO:IN:CAT? CURR:LIM,CURR:LIM1,CURR:LIM2,CURR:LIM3,FREQ,KVA:LIM,KVA:LIM1,KVA:LIM2,KVA:LIM3,OFF,PHAS2,PHAS3,POW:LIM,POW:LIM1,POW:LIM2,POW:LIM3,VOLT:AC,VOLT:AC1,VOLT:AC2,VOLT:AC3,VOLT:DC,VOLT:DC1,VOLT:DC2,VOLT:DC3

Command Syntax	SYSTem:AIO:INput[n]:GAIN <nr2>
Description	Sets the full-scale gain of the ADF parameter controlled by the analog input.
Parameters	Full scale value
Parameter Format	<nr2>
Example	SYST:AIO:IN1:GAIN 230.0
Query Format	SYSTem:AIO:INput[n]:GAIN?
Returned Data Format	<nr2>
Query Example	SYST:AIO:IN1:GAIN? 230.00
Query Format	SYSTem:AIO:INput[n]:GAIN:DEFault?
Description	Returns the default full-scale gain for the specified analog input.
Parameters	None
Returned Data Format	<nr2>
Query Example	SYST:AIO:IN1:GAIN:DEF? 300.0
Query Format	SYSTem:AIO:INput[n]:GAIN:MAXimum?
Description	Returns the maximum full-scale gain for the specified analog input.
Parameters	None
Returned Data Format	n/a
Query Example	SYST:AIO:IN1:GAIN:MAX? 100000.000000
Query Format	SYSTem:AIO:INput[n]:GAIN:MINimum?
Description	Returns the minimum full-scale gain for the specified analog input.
Parameters	None
Returned Data Format	n/a
Query Example	SYST:AIO:IN1:GAIN:MIN? -100000.000000
Command Syntax	SYSTem:AIO:INput[n]:OFFSET <nr2>
Description	Sets the offset of the ADF parameter controlled by the analog input.
Parameters	Offset
Parameter Format	<nr2>
Example	SYST:AIO:IN1:OFFSET 50.0
Query Format	SYSTem:AIO:INput[n]:OFFSET?
Returned Data Format	<nr2>
Query Example	SYST:AIO:IN1:OFFSET? 15.00

Query Format	SYSTem:AIO:INput[n]:OFFSET:DEFault?
Description	Returns the default offset for the specified analog input.
Parameters	None
Returned Data Format	n/a
Query Example	SYST:AIO:IN1:OFFSET:DEF? 15.0
Query Format	SYSTem:AIO:INput[n]:OFFSET:MAXimum?
Description	Returns the maximum offset for the specified analog input.
Parameters	None
Returned Data Format	n/a
Query Example	SYST:AIO:IN1:OFFSET:MAX? 100000.000000
Query Format	SYSTem:AIO:INput[n]:OFFSET:MINimum?
Description	Returns the minimum offset for the specified analog input.
Parameters	None
Returned Data Format	n/a
Query Example	SYST:AIO:IN1:OFFSET:MIN? -100000.000000
Command Syntax	SYSTem:AIO:INput[n]:RANGe <nr2>
Description	Sets the range of the specified analog input. Available range is 0.0 ~ 10.
Parameters	Offset
Parameter Format	<nr2>
Example	SYST:AIO:IN1:RANG 50.0
Query Format	SYSTem:AIO:INput[n]:RANGe?
Returned Data Format	<nr2>
Query Example	SYST:AIO:IN1:RANG? 10.00
Query Format	SYSTem:AIO:INput[n]:RANGe:DEFault?
Description	Returns the default range for the specified analog input.
Parameters	None
Returned Data Format	n/a
Query Example	SYST:AIO:IN1:RANG:DEF? 0.0
Query Format	SYSTem:AIO:INput[n]:RANGe:MAXimum?
Description	Returns the maximum range for the specified analog input.
Parameters	None
Returned Data Format	n/a
Query Example	SYST:AIO:IN1:RANG:MAX? 10.0

Query Format	SYSTem:AIO:INput[n]:RANGe:MINimum?
Description	Returns the minimum range for the specified analog input.
Parameters	None
Returned Data Format	n/a
Query Example	SYST:AIO:IN1:RANG:MIN? 0.0
Query Format	SYSTem:AIO:INput[n]:UNITs?
Description	Returns the assigned unit for the specified analog input port.
Parameters	None
Returned Data Format	<cr>
Query Example	SYST:AIO:IN2:UNIT? Vrms
Query Format	SYSTem:AIO:INput[n]:VOLTage?
Description	Returns the voltage value at the specified analog input port.
Parameters	None
Returned Data Format	<nr2>
Query Example	SYST:AIO:IN2:VOLT? 4.895

8.10.1.2 SYSTem:AIO:OUTput

Command Syntax	SYSTem:AIO:OUTput[n] <cr>
Description	Sets the ADF measurement that is mapped to each analog output port.
Parameters	[MEAS:CURR1? MEAS:CURR2? MEAS:CURR3? MEAS:CURR:CREST1? MEAS:CURR:CREST2? MEAS:CURR:CREST3? MEAS:CURR:CREST? MEAS:CURR:DC1? MEAS:CURR:DC2? MEAS:CURR:DC3? MEAS:CURR:DC? MEAS:CURR:PEAK1? MEAS:CURR:PEAK2? MEAS:CURR:PEAK3? MEAS:CURR:PEAK? MEAS:CURR? MEAS:FREQ? MEAS:KVA1? MEAS:KVA2? MEAS:KVA3? MEAS:KVA? MEAS:PF1? MEAS:PF2? MEAS:PF3? MEAS:PF? MEAS:POW1? MEAS:POW2? MEAS:POW3? MEAS:POW? MEAS:VLL:AC1? MEAS:VLL:AC2? MEAS:VLL:AC3? MEAS:VLL:AC? MEAS:VLL:ACDC1? MEAS:VLL:ACDC2? MEAS:VLL:ACDC3? MEAS:VLL:ACDC? MEAS:VLL:DC1? MEAS:VLL:DC2? MEAS:VLL:DC3? MEAS:VLL:DC? MEAS:VOLT:AC1? MEAS:VOLT:AC2? MEAS:VOLT:AC3? MEAS:VOLT:AC? MEAS:VOLT:ACDC1? MEAS:VOLT:ACDC2? MEAS:VOLT:ACDC3? MEAS:VOLT:ACDC? MEAS:VOLT:DC1? MEAS:VOLT:DC2? MEAS:VOLT:DC3? MEAS:VOLT:DC?] See the “SYSTem:AIO:OUTput:CATalog?” command for a list of available parameters.
Parameter Format	<cr>
Example	SYST:AIO:OUT1 VRMS
Query Format	SYSTem:AIO:OUTput[n]?
Returned Data Format	<cr>
Query Example	SYST:AIO:OUTP? VRMS
Query Format	SYSTem:AIO:OUTput:CATalog?
Description	Returns list of available analog outputs
Returned Data Format	<cr>
Query Example	SYST:AIO:OUT:CAT? MEAS:CURR1?,MEAS:CURR2?,MEAS:CURR3?,MEAS:CURR:CREST1?,MEAS:CURR:CREST2?,MEAS:CURR:CREST3?,MEAS:CURR:CREST?,MEAS:CURR:DC1?,MEAS:CURR:DC2?,MEAS:CURR:DC3?,MEAS:CURR:DC?,MEAS:CURR:PEAK1?,MEAS:CURR:PEAK2?,MEAS:CURR:PEAK3?,MEAS:CURR:PEAK?,MEAS:CURR?,MEAS:FREQ?,MEAS:KVA1?,MEAS:KVA2?,MEAS:KVA3?,MEAS:KVA?,MEAS:PF1?,MEAS:PF2?,MEAS:PF3?,MEAS:PF?,MEAS:POW1?,MEAS:POW2?,MEAS:POW3?,MEAS:POW?,MEAS:VLL:AC1?,MEAS:VLL:AC2?,MEAS:VLL:AC3?,MEAS:VLL:AC?,MEAS:VLL:ACDC1?,MEAS:VLL:ACDC2?,MEAS:VLL:ACDC3?,MEAS:VLL:ACDC?,MEAS:VLL:DC1?,MEAS:VLL:DC2?,MEAS:VLL:DC3?,MEAS:VLL:DC?,MEAS:VOLT:AC1?,MEAS:VOLT:AC2?,MEAS:VOLT:AC3?,MEAS:VOLT:AC?,MEAS:VOLT:ACDC1?,MEAS:VOLT:ACDC2?,MEAS:VOLT:ACDC3?,MEAS:VOLT:ACDC?,MEAS:VOLT:DC1?,MEAS:VOLT:DC2?,MEAS:VOLT:DC3?,MEAS:VOLT:DC?

Command Syntax	SYSTem:AIO:OUTput[n]:GAIN <nr2>
Description	Sets the full-scale gain of the ADF measurement mapped to the analog input.
Parameters	Full scale value
Parameter Format	<nr2>
Example	SYST:AIO:OUT1:GAIN 230.0
Query Format	SYSTem:AIO:OUTput[n]:GAIN?
Returned Data Format	<nr2>
Query Example	SYST:AIO:OUT1:GAIN? 425.0000
Query Format	SYSTem:AIO:OUTput[n]:GAIN:DEFault?
Description	Returns the default full-scale gain for the specified analog output port.
Parameters	None
Returned Data Format	n/a
Query Example	SYST:AIO:OUT1:GAIN:DEF? 425.0000
Query Format	SYSTem:AIO:OUTput[n]:GAIN:MAXimum?
Description	Returns the maximum gain for the specified analog output port.
Parameters	None
Returned Data Format	n/a
Query Example	SYST:AIO:OUT1:GAIN:MAX? 100000.00000
Query Format	SYSTem:AIO:OUTput[n]:GAIN:MINimum?
Description	Returns the minimum gain for the specified analog output port.
Parameters	None
Returned Data Format	n/a
Query Example	SYST:AIO:OUT1:GAIN:MIN? -100000.00000
Command Syntax	SYSTem:AIO:OUTput[n]:OFFSET <nr2>
Description	Sets the offset of the specified analog output port.
Parameters	Offset
Parameter Format	<nr2>
Example	SYST:AIO:OUT1:OFFSET 50.0
Query Format	SYSTem:AIO:OUTput[n]:OFFSET?
Returned Data Format	<nr2>
Query Example	SYST:AIO:OUT1:OFFSET? 50.00

Query Format	SYSTem:AIO:OUTput[n]:OFFSET:DEFault?
Description	Returns the default offset for the specified analog output port.
Parameters	None
Returned Data Format	n/a
Query Example	SYST:AIO:OUT1:OFFSET:DEF? 0.00000
Query Format	SYSTem:AIO:OUTput[n]:OFFSET:MAXimum?
Description	Returns the maximum gain for the specified analog output port.
Parameters	None
Returned Data Format	n/a
Query Example	SYST:AIO:OUT1:GAIN:MAX? 100000.00000
Query Format	SYSTem:AIO:OUTput[n]:OFFSET:MINimum?
Description	Returns the minimum gain for the specified analog output port.
Parameters	None
Returned Data Format	n/a
Query Example	SYST:AIO:OUT1:GAIN:MIN? -100000.00000
Command Syntax	SYSTem:AI:OUTput[n]:GAIN <nr2>
Description	Sets the full-scale gain of the specified analog output port.
Parameters	Full scale value
Parameter Format	<nr2>
Example	SYST:AIO:OUT1:GAIN 230.0
Query Format	SYSTem:AIO:OUTput[n]:GAIN?
Returned Data Format	<nr2>
Query Example	SYST:AIO:OUT1:GAIN? 230.00
Query Format	SYSTem:AIO:OUTput[n]:GAIN:DEFault?
Description	Returns the default full-scale gain for the specified analog output.
Parameters	None
Returned Data Format	<nr2>
Query Example	SYST:AIO:OUT1:GAIN:DEF? 425.00000
Query Format	SYSTem:AIO:OUTput[n]:GAIN:MAXimum?
Description	Returns the maximum full-scale gain for the specified analog output.
Parameters	None
Returned Data Format	n/a
Query Example	SYST:AIO:OUT1:GAIN:MAX? 100000.00000

Query Format	SYSTem:AIO:OUTput[n]:GAIN:MINimum?
Description	Returns the minimum full-scale gain for the specified analog output.
Parameters	None
Returned Data Format	n/a
Query Example	SYST:AIO:OUT1:GAIN:MIN? -100000.00000

Query Format	SYSTem:AIO:OUTput[n]:UNITs?
Description	Returns the assigned unit for the specified analog output port.
Parameters	None
Returned Data Format	<cr>
Query Example	SYST:AIO:OUT2:UNIT? Vrms

Query Format	SYSTem:AIO:OUTput[n]:VOLTage?
Description	Returns the voltage at the analog output port.
Parameters	None
Returned Data Format	<nr2>
Query Example	SYST:AIO:OUT2:VOLT? 7.2590

8.10.1.3 SYSTem:DIO:Input

Query Format	SYSTem:DIO:INput[n]?
Description	Queries status of Digital Input 1, 2 or 3. If I/O number is omitted, all three input values are returned. n = 1, 2 or 3.
Parameters	none
Returned Data Format	<cr>
Parameter Format	<nr1>
Query Example	SYST:DIO:IN2? 0

Command Syntax	SYSTem:DIO:INput[n]:FALLing <cr>
	SYSTem:DIO:INput[n]:RISing <cr>
Description	Sets the SCPI command to be executed at the rising or falling event of that digital input [n]. n = 1, 2 or 3.
Parameters	SCPI command string
Parameter Format	<cr>
Example	SYST:DIO:IN1:FALL "OUTP 0" SYST:DIO:IN1:RIS "OUTP 1" These settings will enable the output at the rising edge of the pulse and disable it at the falling edge.
Query Format	SYSTem:DIO:INput[n]:FALLing? SYSTem:DIO:INput[n]:RISing?
Returned Data Format	<cr>
Query Example	SYST:DIO:IN1:RIS? OUTP 1 SYST:DIO:IN1:FALL? -
Command Syntax	SYSTem:DIO:INput[n]:FILtersize <nr1>
Description	Defines the time in ms (milliseconds) that the digital input has to keep the state after a transition in order to generate the event. If filtersize is zero, then the event is immediately generated, otherwise the specified time will prevent short pulses from generating events. This is useful in noisy environments and also if the digital signal is controlled by a switch or a mechanical actuator.
Parameters	0 – 1000
Parameter Format	<nr1>
Example	SYST:DIO:IN1:FIL 8
Query Format	SYSTem:DIO:INput[n]:FILtersize?
Returned Data Format	<nr1>
Query Example	SYST:DIO:IN1:FIL? 8
Query Format	SYSTem:DIO:INput[n]:FILtersize:DEFault?
Description	Returns the default filter size value.
Returned Data Format	<nr1>
Query Example	SYST:DIO:IN1:FIL:DEF? 0
Query Format	SYSTem:DIO:INput[n]:FILtersize:MAXimum?
Description	Returns the maximum allowed filter size value.
Returned Data Format	<nr1>
Query Example	SYST:DIO:IN1:FIL:MAX? 1000

Query Format	SYSTem:DIO:INput[n]:FILtersize:MINimum?
Description	Returns the minimum allowed filter size value.
Returned Data Format	<nr1>
Query Example	SYST:DIO:IN1:FIL:MIN? 1

8.10.1.4 SYSTem:DIO:OUTput

Command Syntax	SYSTem:DIO:OUTput[n] <MODE>
Description	Sets output value of digital output n. n = 1 or 2.
Parameter 1	MODE The mode determines when an output is generated. Available MODE settings are: <ul style="list-style-type: none"> • 1, ON, 0, OFF it is used as general purpose output. [0 LOW 1 HIGH] • OUTPUT_STATE indicates output enabled(1) or disabled(0). • FORM indicates single(1) or split/three(0). • FAULT indicates fault(1) or no fault(0). • TRANSIENT indicates when a transient is running/paused/stepping(1) or stopped(0). • PROGRAM indicates when a program is in execution at steady state level(1) or manual mode(0). • REMOTE indicates remote(1) or local(0) state Defaults are: OUTPUT1: OUTPUT_STATE OUTPUT2: FORM
Parameter Format	<cr>
Example	SYST:DIO:OUT1 FAULT
Query Format	SYSTem:DIO:OUTput[n]?
Description	Returns settings for selected pin number n
Returned Data Format	<nr1>
Query Example	SYST:DIO:OUT1? OUTPUT STATE,NON-INVERTING
Query Format	SYSTem:DIO:OUTput:CATalog?
Description	Returns list of available digital outputs
Returned Data Format	<cr>
Query Example	SYST:DIO:OUT:CAT? COUPLING,FAULT,FORM,HIGH,LOW,OUTPUT STATE,PROGRAM,REMOTE,TRANSIENT

Command Syntax **SYSTem:DIO:OUTput[n]:INVert**
 Description Inverts the logic polarity of the selected digital output.
 Parameters [0 | NORMAL | 1 | INVERT]
 Example SYST:DIO:OUT1 1
 Query Format **SYSTem:DIO:OUTput[n]:INVert?**
 Description Returns logic inversion setting
 Returned Data Format <nr1>
 Query Example SYST:DIO:OUT1:INV?
 1

Query Format **SYSTem:DIO:OUTput[n]:STATe?**
 Description Returns logic level of selected output pin.
 Returned Data Format
 Query Example SYST:DIO:OUT1:STAT?
 1

8.10.1.5 SYSTem:DIO:REMOte

Command Syntax **SYSTem:DIO:REMOte:ENABle **
 Description Turns the remote enable state on or off
 Parameters < 0 | OFF | 1 | ON >
 Parameter Format
 Example SYST:DIO:REMOte:ENABle 1
 Query Format **SYSTem:DIO:REMOte:ENABle?**
 Returned Data Format
 Query Example SYST:DIO:REM:ENA?
 1

Command Syntax **SYSTem:DIO:REMOte:ENABle:AUTO **
 Description Enables or Disables the Remote Input function at power on. By default, on a regular AFX/ADF it is 1 for backward compatibility. When it is 1 it enables the output immediately when remote enable is set to 1 or when the unit boots. A warning will be displayed on the LCD and a beep will sound before the output enables. When it is 0 it only enables the output when it detects a 0 to 1 change in the input and disables the output with a 1 to 0. Both settings can be changed by the user. Sending a sanitize command returns this setting back to 1 and 0 respectively.
Note: This command requires firmware rev 2.2.28 or higher.

Parameters < 0 | OFF | 1 | ON >
 Parameter Format
 Example SYST:DIO:REMOte:ENABle:AUTO 1
 Query Format **SYSTem:DIO:REMOte:ENABle:AUTO?**
 Returned Data Format
 Query Example SYST:DIO:REM:ENA:AUTO?
 1

Command Syntax	SYSTem:DIO:REMOte:INHibit
Description	Turns the remote inhibit state on or off
Parameters	< 0 OFF 1 ON >
Parameter Format	
Example	SYST:DIO:REMOte:INHibit 1
Query Format	SYSTem:DIO:REMOte:INHibit?
Returned Data Format	
Query Example	SYST:DIO:REM:INH? 1

8.10.1.6 SYSTem:DIO:STROBE

Command Syntax	SYSTem:DIO:STROBE:OUTPustate
Description	Sets the function strobe mode active when the output relay changes state
Parameters	< 0 OFF 1 ON >
Parameter Format	
Example	SYST:DIO:STROBE:OUTP 1
Query Format	SYSTem:DIO:STROBE:OUTPustate?
Returned Data Format	
Query Example	SYST:DIO:STROBE:OUTP? 1
Command Syntax	SYSTem:DIO:STROBE:SOURce
Description	Sets the function strobe mode to program changes.
Parameters	< 0 OFF 1 ON >
Parameter Format	
Example	SYST:DIO:STROBE:SOUR 1
Query Format	SYSTem:DIO:STROBE:SOURce?
Returned Data Format	
Query Example	SYST:DIO:STROBE:SOUR? 1
Command Syntax	SYSTem:DIO:STROBE:TRANsient
Description	Sets the function strobe mode to generate an output at the start of a transient execution.
Parameters	< 0 OFF 1 ON >
Parameter Format	
Example	SYST:DIO:STROBE:TRAN 1
Query Format	SYSTem:DIO:STROBE:TRANsient?
Returned Data Format	
Query Example	SYST:DIO:STROBE:TRAN? 1

8.10.2 SOURce:SYNChronize Commands

```
SOURce:SYNChronize
  [:INput][?]
    :PHASEshift[?]
    :RANGE[?]
    :SOURCE[?]
    :SPeed[?]
    :STATe?

SOURce:SYNChronize
  :OUTPut[?]
```

8.10.2.1 SOURce:SYNChronize[:INput]

Command Syntax	SOURce:SYNChronize[:INput]
Description	This command enables or disables the external sync input mode.
Parameters	[0 OFF 1 ON]
Parameter Format	
Example	SOUR:SYNC 1
Query Format	SOURce:SYNChronize[:INput]?
Returned Data Format	
Query Example	SOUR:SYNC? 1

Command Syntax	SOURce:SYNChronize[:Input]:PHASEshift <nr2>
Description	Defines a fixed phase shift between phase A waveform generation and the external sync source. Used to calibrate any phase difference between the sync signal and the power source output on phase A.
Parameters	Phase shift
Parameter Format	<nr>
Example	SOUR:SYNC:PHASE 2.8
Query Format	SOURce:SYNChronize[:Input]:PHASEshift?
Returned Data Format	<nr2>
Query Example	SOUR:SYNC:PHASE? 0.5

<p>Command Syntax Description</p>	<p>SOURce:SYNChronize[:Input]:RANGe <nr2> Allows configuration of how much the synchronization engine is able to deviate from the ADF programmed frequency. This helps to keep the waveform frequency under control, even if the external source is not present all the time. The synchronization engine is limited to frequencies of FSETPOINT +/- FRANGE.</p>
<p>Parameters Parameter Format Example Query Format Returned Data Format Query Example</p>	<p>Range in Hz <nr2> SOUR:SYNC:RANG 5.0 SOURce:SYNChronize[:Input]:RANGe? <nr2> SOUR:SYNC:RANGe? 10.000</p>
<p>Command Syntax Description</p>	<p>SOURce:SYNChronize[:Input]:SOURce <cr> This command selects either the external sync TTL (1) or the internal AC line sync (0) mode. The internal AC sync signal is derived from the power sources three phase L-L voltages so a phase adjustment for Phase A output will be needed using the SOURce:SYNChronize[:Input]:PHASEshift command.</p>
<p>Parameters Parameter Format Example Query Format Returned Data Format Query Example</p>	<p>[0 AC 1 TTL] <cr> SOUR:SYNC:SOUR TTL SOURce:SYNChronize[:Input]:SOURce? <cr> SOUR:SYNC:SOUR? 1</p>
<p>Command Syntax Description</p>	<p>SOURce:SYNChronize[:Input]:SPeEd <nr2> Allows accelerating the speed of the internal synchronization engine (PLL) in case the external sync source is not constant and presents periodic or continuous changes. A slower speed improves the stability of the waveform frequency, so it is recommended to keep use the smallest possible speed values.</p>
<p>Parameters Parameter Format Example Query Format Returned Data Format Query Example</p>	<p>Speed (multiplier value) <nr1> Range is 1.000 ~ 10.000 SOUR:SYNC:SP 0.50 SOURce:SYNChronize[:Input]:SPeEd? <nr2> SOUR:SYNC:SP? 2.500</p>

Query Command	SOURce:SYNChronize[:Input]:STATe?
Description	This query only command returns the status of the Phase Lock Loop (PLL). A "0" response indicates the PLL has not locked on to the sync input yet. A 1 response indicates the PLL is locked.
Returned Data Format	
Returned Data	0 = PLL is not locked 1 = PLL is locked
Query Example	SOUR:SYNC:STAT? 1

8.10.2.2 SOURce:SYNChronize[:OUTput]

Command Syntax	SOURce:SYNChronize:OUTput
Description	This command enables the SYNC output
Query Format	SOURce:SYNChronize:OUTput?
Returned Data Format	
Returned Data	0 = SYNC output off 1 = SYNCoutput on
Query Example	SOUR:SYNC:OUT? 1

8.10.3 PROGram:TRANsient Triggers Commands

```

PROGram:TRANsient:TRIGger
    :Input[?]
        :IMMEDIATE[?]
        :AUTOrun[?]

    :OUTput[?]
    
```

8.10.3.1 PROGram:TRANsient

The following **PROGram:TRANsient:TRIGger** commands are available.

Command Syntax	PROGram:TRANsient:TRIGger:INput
Description	When the trigger input is active, this command selects the trigger input source mode as on or off. When ON, the external trigger input is enabled.
Parameters	[0 OFF 1 ON]
Parameter Format	
Example	PROG:TRAN:TRIG:IN 1
Query Format	PROGram:TRANsient:TRIGger:INput?
Returned Data Format	
Query Example	PROG:TRAN:TRIG:IN? 1
Command Syntax	PROGram:TRANsient:TRIGger:INput:IMMEDIATE
Description	When the trigger input is active, this command starts the transient segments immediately after the trigger input is received, without waiting for the zero crossing, as determined by the update phase setting. Refer to SOURce:UPDATEPHase
Parameters	[0 OFF 1 ON]
Parameter Format	
Example	PROG:TRAN:TRIG:IN:IMM 1
Query Format	PROGram:TRANsient:TRIGger:INput:IMMEDIATE?
Returned Data Format	
Query Example	PROG:TRAN:TRIG:IN:IMM? 1

Command Syntax	PROG:TRANSient:TRIGger:INput:AUTOrun
Description	When the trigger input is active and segments are running state, each trigger event (pulse) will automatically start a new sequence, without the need of a new RUN command before each trigger. The RUN command has to be executed only once, and then each subsequent trigger input event will cause a new segment sequence to run. Note: the trigger signal is level-sensitive; hence if it is kept high, it will continuously issue a trigger.
Parameters	[0 OFF 1 ON]
Parameter Format	
Example	PROG:TRAN:TRIG:IN:AUTO 1
Query Format	PROG:TRANSient:TRIGger:INput:AUTOrun?
Returned Data Format	
Query Example	PROG:TRAN:TRIG:IN:AUTO? 1
Command Syntax	PROG:TRANSient:TRIGger:OUTput
Description	This command causes a trigger output pulse to be generated when a transient execution is started. Note that this output is used as a function strobe during steady state operation.
Parameters	[0 OFF 1 ON]
Parameter Format	
Example	PROG:TRAN:TRIG:OUT 1
Query Format	PROG:TRANSient:TRIGger:OUTput?
Returned Data Format	
Query Example	PROG:TRAN:TRIG:OUT? 1

8.10.4 AUX I/O Calibration Commands

```

SYSTem:AIO
  :INPut#
    :CALibration
      :GAIN{?}
        :DEFault{?}
        :MAXimum
        :MINimum
      :OFFset{?}
        :DEFault{?}
        :MAXimum
        :MINimum
  :OUTput#
    :CALibration
      :GAIN{?}
        :DEFault{?}
        :MAXimum
        :MINimum
      :OFFset{?}
        :DEFault{?}
        :MAXimum
        :MINimum

```

8.10.4.1 SYSTem:AIO:INPut#:CALibration

Command Syntax	SYSTem:AIO:INput[n]:CALibration:GAIN <nr2>
Description	Calibrates the full scale gain of the ADF parameter controlled by the analog input.
Parameters	Reference
Parameter Format	<nr2>
Example	SYST:AIO:IN1:CAL:GAIN 100.0
Query Format	SYSTem:AIO:INput[n]:CALibration:GAIN?
	Returns calibration coefficient
Returned Data Format	<nr2>
Query Example	SYST:AIO:IN1:CAL:GAIN? 1.000
Query Command	SYSTem:AIO:INput[n]:CALibration:GAIN:DEFAult?
	Returns default calibration coefficient value
Returned Data Format	<nr2>
Query Example	SYST:AIO:IN1:CAL:GAIN:DEF? 1.000
Query Command	SYSTem:AIO:INput[n]:CALibration:GAIN:MAXimum?
	Returns upper limit of calibration coefficient value
Returned Data Format	<nr2>
Query Example	SYST:AIO:IN1:CAL:GAIN:MAX? 1.000

Query Command	SYSTem:AIO:INput[n]:CALibration:GAIN:MINimum? Returns lower limit of calibration coefficient value
Returned Data Format	<nr2>
Query Example	SYST:AIO:IN1:CAL:GAIN:MIN? 0.000
Command Syntax Description	SYSTem:AIO:INput[n]:CALibration:OFFset <nr2> Calibrates the full scale gain of the ADF parameter controlled by the analog input.
Parameters	Reference
Parameter Format	<nr2>
Example	SYST:AIO:IN1:CAL:OFF 0.01
Query Format	SYSTem:AIO:INput[n]:CALibration:OFFset? Returns calibration coefficient
Returned Data Format	<nr2>
Query Example	SYST:AIO:IN1:CAL:OFF? 0.010
Query Command	SYSTem:AIO:INput[n]:CALibration:OFFset:DEFault? Returns default calibration coefficient value
Returned Data Format	<nr2>
Query Example	SYST:AIO:IN1:CAL:OFF:DEF? 1.000
Query Command	SYSTem:AIO:INput[n]:CALibration:OFFset:MAXimum? Returns upper limit of calibration coefficient value
Returned Data Format	<nr2>
Query Example	SYST:AIO:IN1:CAL:OFF:MAX? 1.000

Query Command **SYSTem:AIO:INput[n]:CALibration:OFFset:MINimum?**
Returns lower limit of calibration coefficient value

Returned Data Format <nr2>

Query Example SYST:AIO:IN1:CAL:OFF:MIN?
1.000

8.10.4.2 SYSTem:AIO:OUTput#:CALibration

Command Syntax **SYSTem:AIO:OUTput[n]:CALibration:GAIN <nr2>**

Description Calibrates the full scale gain of the ADF parameter controlled by the analog output.

Parameters Reference

Parameter Format <nr2>

Example SYST:AIO:OUT1:CAL:GAIN 100.0

Query Format **SYSTem:AIO:OUTput[n]:CALibration:GAIN?**
Returns calibration coefficient

Returned Data Format <nr2>

Query Example SYST:AIO:OUT1:CAL:GAIN?
1.000

Query Command **SYSTem:AIO:OUTput[n]:CALibration:GAIN:DEFault?**
Returns default calibration coefficient value

Returned Data Format <nr2>

Query Example SYST:AIO:OUT1:CAL:GAIN:DEF?
1.000

Query Command **SYSTem:AIO:OUTput[n]:CALibration:GAIN:MAXimum?**
Returns upper limit of calibration coefficient value

Returned Data Format <nr2>

Query Example SYST:AIO:OUT1:CAL:GAIN:MAX?
1.000

Query Command **SYSTem:AIO:OUTput[n]:CALibration:GAIN:MINimum?**
Returns lower limit of calibration coefficient value

Returned Data Format <nr2>

Query Example SYST:AIO:OUT1:CAL:GAIN:MIN?
0.000

Command Syntax	SYSTem:AIO:OUTput[n]:CALibration:OFFset <nr2>
Description	Calibrates the full scale gain of the ADF parameter controlled by the analog output.
Parameters	Reference
Parameter Format	<nr2>
Example	SYST:AIO:OUT1:CAL:OFF 0.01
Query Format	SYSTem:AIO:OUTput[n]:CALibration:OFFset?
	Returns calibration coefficient
Returned Data Format	<nr2>
Query Example	SYST:AIO:OUT1:CAL:OFF? 0.010
Query Command	SYSTem:AIO:OUTput[n]:CALibration:OFFset:DEFault?
	Returns default calibration coefficient value
Returned Data Format	<nr2>
Query Example	SYST:AIO:OUT1:CAL:OFF:DEF? 1.000
Query Command	SYSTem:AIO:OUTput[n]:CALibration:OFFset:MAXimum?
	Returns upper limit of calibration coefficient value
Returned Data Format	<nr2>
Query Example	SYST:AIO:OUT1:CAL:OFF:MAX? 1.000
Query Command	SYSTem:AIO:OUTput[n]:CALibration:OFFset:MINimum?
	Returns lower limit of calibration coefficient value
Returned Data Format	<nr2>
Query Example	SYST:AIO:OUT1:CAL:OFF:MIN? 1.000

8.11 IEEE488.2 Common Commands

The following IEEE488.2 common commands (a.k.a. star commands) are supported by the AC power source. These commands are provided for compatibility with the IEEE488.2 standard. They are aliases to the relevant proprietary command and can be used interchangeably. Commands are shown in alphabetical order.

IEEE488.2 Command	Description	Group	Mandatory
*CLS	Clear Status	Status and Event	Yes
*DCL	Device Clear	Internal Operations	
*ESE <n>	Event Status Register Enable	Status and Event	Yes
*ESE?	ESE Query	Status and Event	Yes
*ESR?	Event Status Register Query	Status and Event	Yes
*GTL	Goto Local	Control	
*IDN?	Identify	System Data	Yes
*LLO	Local Lock Out	Control	Yes
*OPC	Operation Complete	Synchronization	Yes
*OPC?	OPC Status Query	Synchronization	Yes
*RST	Reset	Internal Operations	Yes
*SRE	Service Request Enable	Status and Event	Yes
*SRE?	SRE Query	Status and Event	Yes
*STB?	Status Byte Query	Status and Event	Yes
*TRG	Trigger	Synchronization	
*WAI	Wait	Synchronization	Yes

Table 8-2: Mandatory IEEE488.2 Common Commands

Command Syntax
Description

*CLS

Clear Status. The Clear Status (CLS) command clears the status byte by emptying the error queue and clearing all the event registers including the Data Questionable Event Register, the Standard Event Status Register, the Standard Operation Status Register and any other registers that are summarized in the status byte.

Command Syntax
Description
Parameters
Parameter Format

*DCL

Device Clear. Resets the instrument to a default state.

None

n/a

Command Syntax Description	*ESE<nr1> Selects the desired bits from the standard event status enable register. The variable <nr1> represents the sum of the bits that will be enabled. This register monitors I/O errors and synchronization conditions such as operation complete, request control, query error, device dependent error, status execution error, command error and power on. The selected bits are OR'd to become a summary bit (bit 5) in the byte register which can be queried. The setting by this command is not affected by *RST. However, cycling the power will reset this register to zero. Refer to section 8.12 for register bit values.
Parameters Parameter Format Example Query Format Returned Data Format Query Example	Range 0-255 <nr1> *ESE 128 *ESE? <nr1> *ESE? 193
Query Format Description	*ESR? Event Status Register Query. Reads the contents of the Status Event Register (ESR). After this query, the content of the ESR register is reset. Refer to section 8.12 for register bit values.
Returned Data Format Query Example	<nr1> *ESR? 0
Command Syntax Description Returned Data Format Query Example	*GTL Goto Local. Releases lock of front panel controls. N/A N/A
Query Format Description	*IDN? Identification Query. Returns the unit's Identity string. The IDN string response contains several fields separated by a comma. <i>Query response:</i> Manufacturer, model, serial number, firmware revision.
Returned Data Format Query Example	<cr>,<cr>,<nr1>,<nr2> *IDN? PPSC,3150ADF-4,106378889,2.0.0
Command Syntax Description Parameters Parameter Format	*LLO Local Lock out. Locks out front panel LOCAL function. None n/a

<p>Command Syntax Description</p>	<p>*OPC The Operation Complete (OPC) command sets bit 0 in the Standard Event Status Register when all pending operations have finished. Optional: < BLOCK 0 NOBLOCK 1></p>																				
<p>Parameters Example Query Format Description</p>	<p>*OPC *OPC? < BLOCK 0 NOBLOCK 1> IEEE488.2 standard command. The parameter is optional. The argument is optional, if it is not sent:</p> <ul style="list-style-type: none"> • In UPC compatible mode default argument will be NONBLOCK or 1. • In normal mode default argument will be BLOCK or 0. <p>*OPC? BLOCK 0 Returns 1 when all pending overlapped operations have been completed. It can be used to cause the controller to wait for commands to complete.</p> <p>*OPC? NOBLOCK 1 Returns 1 if all pending overlapped operations have been completed or 0 if there are pending overlapped operations. It will not cause the controller to wait for commands to complete. Pending overlapped operations can be a transient or a soft start using ramp time/slew rates.</p>																				
<p>Returned Data Format Query Example</p>	<p> *OPC? 1</p>																				
<p>Command Syntax Description</p>	<p>*RST RESET. The *RST command (reset) has the same effect as an IEEE-488 Device Clear bus command but can be used over the RS232C, USB or LAN interface as well. This command resets the unit to its power on default state. User defined waveforms or programs are not erased but the mode is set to manual and the transient list table is cleared. (Unless there is a power-on program configured using the [SOURCE:]INITIAL command) <i>Note: A reset cycle of the power source can take up to 20 seconds to complete. When developing test programs, allow this time to pass before sending other commands. Adjust interface time-out settings as needed.</i></p>																				
<p>Parameters Parameter Format RESET STATE</p>	<p>None n/a</p> <table border="0"> <tr> <td>FORM</td> <td>3</td> <td>VOLT:MODE</td> <td>AC</td> </tr> <tr> <td>VOLT:AC</td> <td>0.0000</td> <td>COUPLING</td> <td>DC</td> </tr> <tr> <td>VOLT:DC</td> <td>0.0000</td> <td>RANGE</td> <td>AC</td> </tr> <tr> <td>CURR:AC</td> <td>41.6667</td> <td></td> <td></td> </tr> <tr> <td>CURR:DC</td> <td>20.8333</td> <td></td> <td></td> </tr> </table>	FORM	3	VOLT:MODE	AC	VOLT:AC	0.0000	COUPLING	DC	VOLT:DC	0.0000	RANGE	AC	CURR:AC	41.6667			CURR:DC	20.8333		
FORM	3	VOLT:MODE	AC																		
VOLT:AC	0.0000	COUPLING	DC																		
VOLT:DC	0.0000	RANGE	AC																		
CURR:AC	41.6667																				
CURR:DC	20.8333																				

Command Syntax	*SRE <nr1>
Description	Before reading a status register, bits must be enabled. This command enables bits in the service request register. The current setting is saved in non-volatile memory.
Parameters	0-255
Parameter Format	<nr1>
Example	*SRE 255
Query Format	*SRE?
Description	Reads the current state of the service request enable register. The register is cleared after reading it. Refer to section 8.12 for register bit values.
Returned Data Format	<nr1>
Query Example	*SRE? 255
Query Format	*STB?
Description	Status Byte Query. The *STB? query returns the contents of the status byte register (STB). After this query, the content of the STB register is reset. Refer to section 8.12 for register bit values.
Returned Data Format	<nr1>
Query Example	*STB? 4
Command Syntax	*TRG
Description	Triggers pending operation.
Parameters	None
Parameter Format	n/a
Command Syntax	*WAI
Description	Prohibits the instrument from executing any new commands until all pending overlapped commands have been completed.
Parameters	None
Parameter Format	n/a

8.12 Status and Events Registers

The IEEE488.2 standard defines a standardized status and events register system. Refer to the ANSI/IEEE-488.2 1987 standard for more information. This section provides an overview of these registers and bit positions for various status and error events.

8.12.1 Status Byte Register (STB)

The status register content is returned on a *STB? query. It contains 8 bits as shown in the table below. The return value represents the 8 bits positions and can range from 0-255. A *CLS command will clear the Status Byte Register (STB) and the Event Status Register (ESR). Refer to Figure 8-3, "Status Byte Logical Model".

BIT	NAME	DEFINITION
7	SOS	:STATus:OPERation register bit summary
6	MSS/RQS	- MASTER SUMMARY summarizes all STATUS BYTE bits (except bit 6) for *STB?, or, - REQUEST SERVICE indicates this device requested service when a Serial Poll was performed.
5	ESB	STANDARD EVENT STATUS REGISTER bit summary
4	MAV	MESSAGE AVAILABLE indicates Query response data is available
3	SQS	:STATus:QUESTionable register bit summary
2	EEQ	ERROR/EVENT QUEUE indicates an SCPI Error/Event message is available
1	BUSY	indicates UPC front panel not in V/I mode
0	FAULT	indicates Power Source FAULT

Table 8-3: Status Byte Register (STB)

Note: Setting a SERVICE REQUEST ENABLE (SRE) bit true unmask the STATUS bit in the STB. Bit 6 of the SRE is not applicable as the MASTER SUMMARY bit of the STB cannot be masked. The STB, SRE, ESR and ESE registers are 8 bits each.

The status byte logical model is shown in the figure below.

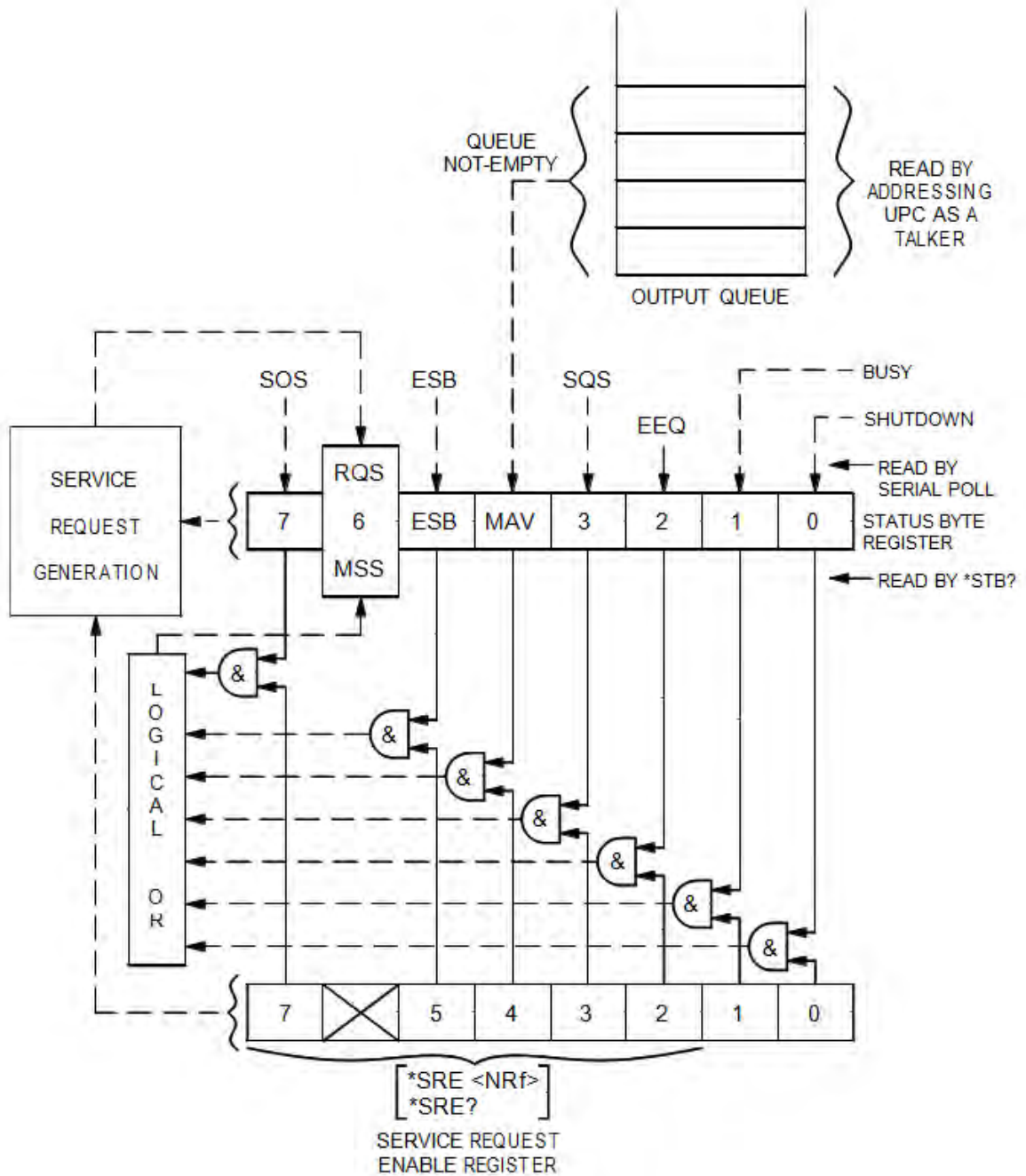

Figure 8-3: Status Byte Logical Model

8.12.2 Status Event Register (ESR)

Events reported by the STANDARD EVENT STATUS register may be queried via the *ESR? command. Reading the ESR register clears it. The EVENT STATUS summary bit in the STATUS BYTE (STB) will be set when an unmasked EVENT STATUS bit goes true.

BIT	NAME	DEFINITION
7	PON	POWER ON indicates Input power was just applied
6	URQ	USER REQUEST indicates "LOCAL" key was just pressed
5	CME	COMMAND ERROR indicates invalid command or query received
4	EXE	EXECUTION ERROR indicates can't execute command with data received
3	DDE	DEVICE DEPENDANT ERROR indicates UPC not properly configured
2	QYE	QUERY ERROR indicates cannot respond with data
1	RQC	REQUEST CONTROL - not used
0	OPC	OPERATION COMPLETE indicates previous operation complete

Table 8-4: Status Event Register (ESR)

Setting an EVENT STATUS ENABLE (ESE) bit true unmask the EVENT bit in the ESR. Also see :SYStem:ERRor? query for relevant information.

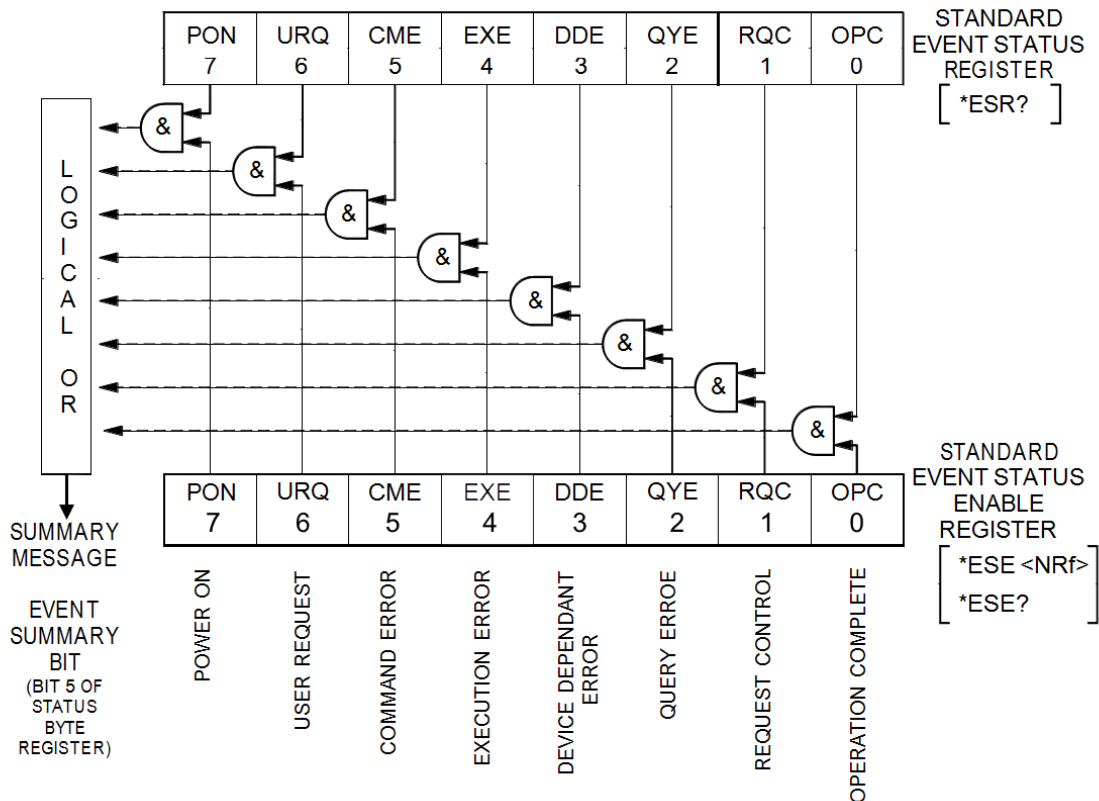

Figure 8-4: Standard Event Register (ESR) Model

8.12.3 SCPI Status Registers

The STATUS:OPERation and STATUS:QUESTIONable registers provide information about the present mode of operation.

- Transition of a CONDITION bit to the true state causes the EVENT bit to be set true.
- Unmasked ENABLE bits allow an EVENT bit to be reported in the summary bit for that EVENT register in the STATUS BYTE register.
- Setting an ENABLE bit true, unmask the corresponding EVENT bit.
- Reading an EVENT register clears it.
- All :STATUS registers are 16 bits (Figure 5.3).

The STATUS:OPERation register provides information about the present mode of operation.

Relevant commands for the STATUS:OPERation register are:

:STATUS:OPERation:CONDition?

:STATUS:OPERation:ENABle

:STATUS:OPERation:ENABle?

:STATUS:OPERation:EVENT?

The STATUS:QUESTIONABLE register provides information about errors and questionable measurements.

Relevant commands for the STATUS:QUESTIONABLE register are:

:STATUS:QUESTIONable:CONDition?

:STATUS:QUESTIONable:ENABle

:STATUS:QUESTIONable:ENABle?

:STATUS:QUESTIONable:EVENT?

Refer to Figure 8-5, “SCPI Status Registers Model” for details on registers.

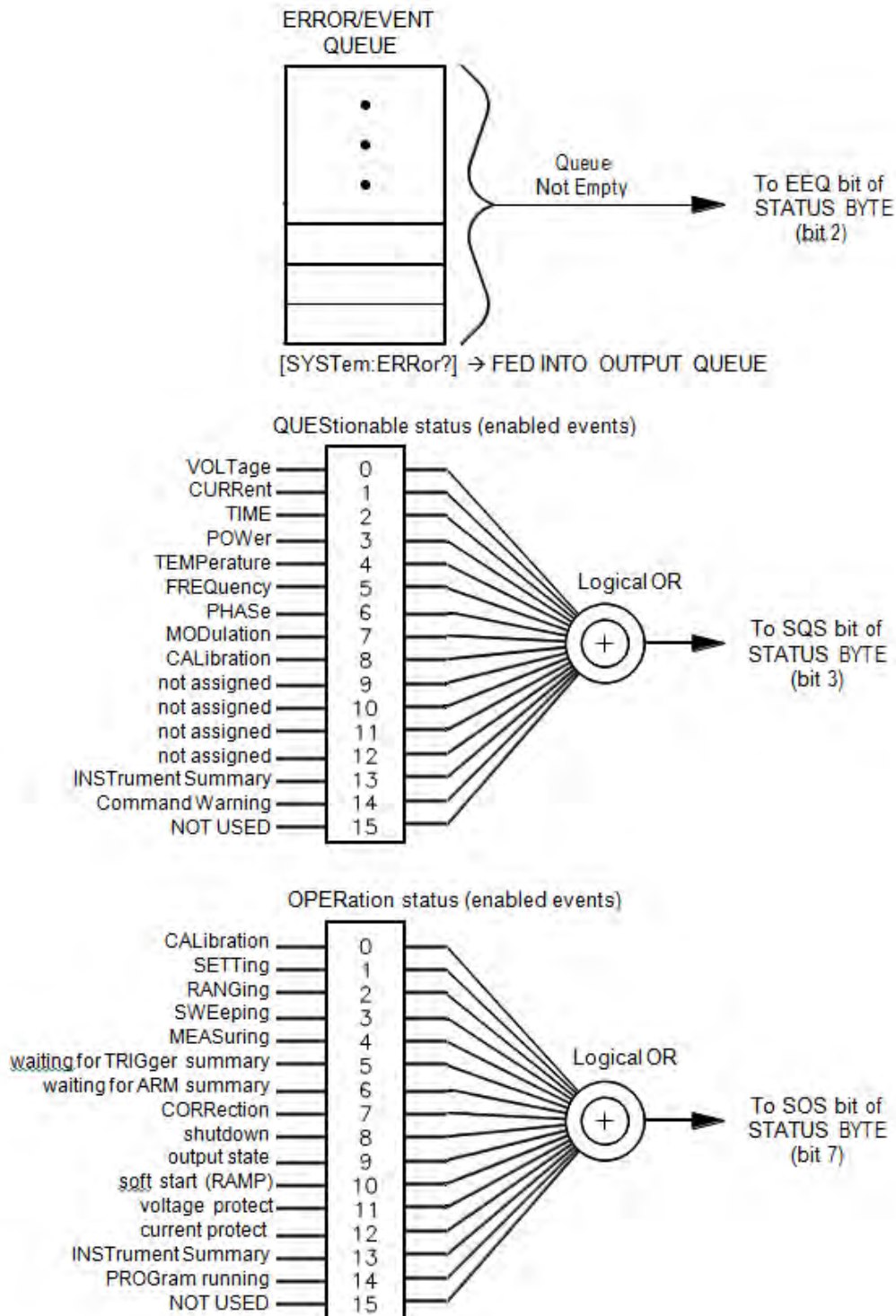

Figure 8-5: SCPI Status Registers Model

9 USB Driver Installation

9.1 Overview

The USB interface provides a virtual COM port for the PC. Via this port, the unit can be controlled as a normal RS232 interface, e. g. with a terminal program or user application program. There are two drivers provided with the ADF units:

- Virtual COM driver** This allows communication with the power sources using a virtual serial port (COMx).
- Network Driver** This allows communication with the power source using a virtual IP address. Using this driver, all built-in web server functions are available via USB using a browser.

9.2 Installation

USB drivers are stored in the ADF controller and installed when the unit is first connected to a Windows PC. Proceed as follows:

1. With the ADF unit powered up, connect a USB cable between the ADF USB Device port on the rear panel and an available USB port on a Windows PC.
2. Once plugged it, the PC should detect the present of the ADF. If this is the first time you connect to this PC, the drivers must be installed. This process should run automatically but if for some reason it does not, follow the subsequent steps.
3. On the drive popup shown below, select the “Open folder to view files” entry.

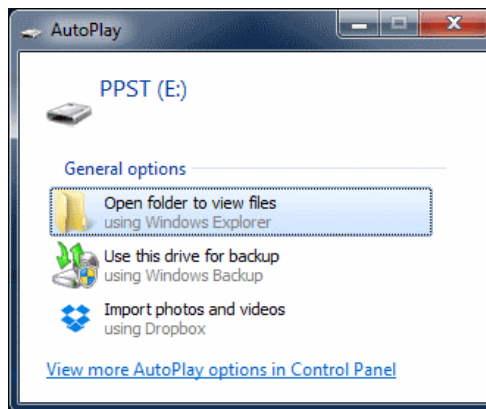

4. The directories shown below will be visible. Select the “drivers” directory

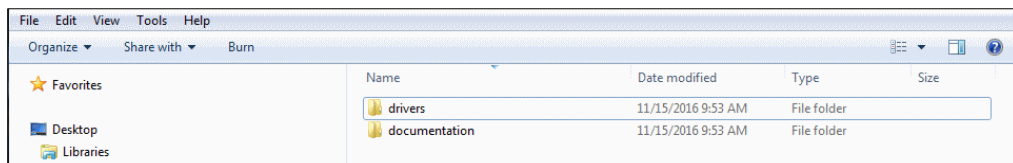

5. Next, select the “Windows” directory

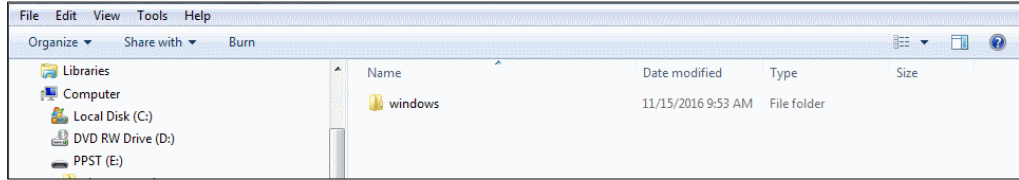

6. Run the “Driver_Installer.exe” located in this directory as shown below.,

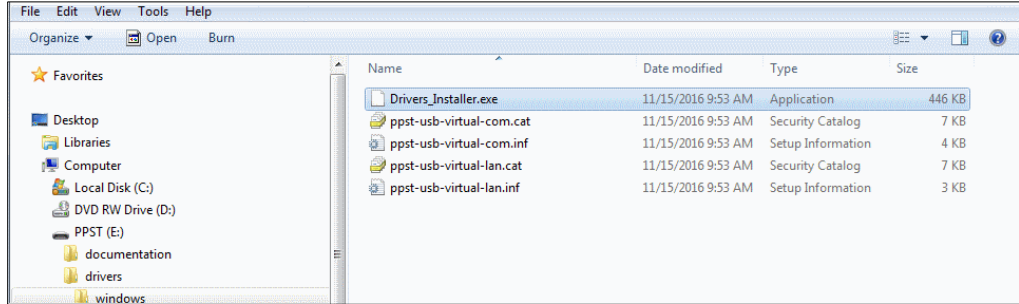

7. Allow the installation to complete.

At the end of this process, you should be able to see the two PPST USB drivers in the Windows Device Manager window under “Network Adaptors” and “Ports (COM & LPT)” respectively. The USB interface is now ready for use.

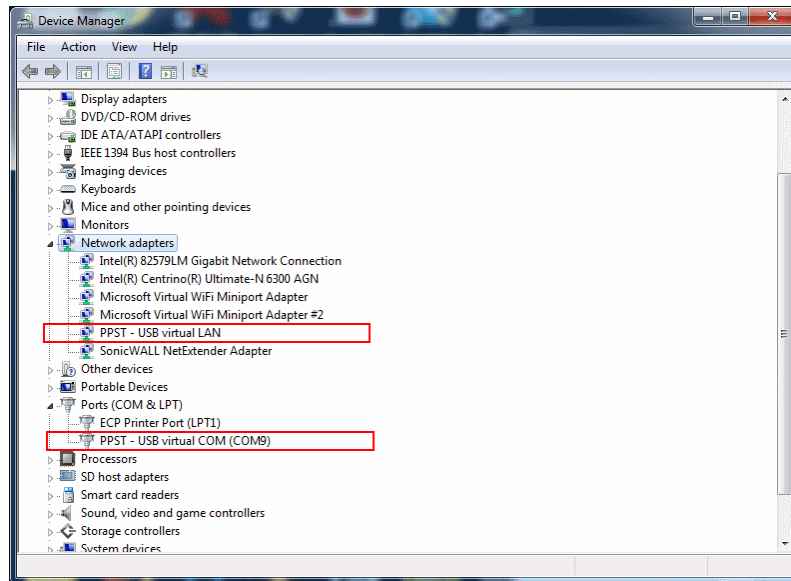

Figure 9-1: PPST USB Drivers visible in Windows Device Manager

10 LAN Interface Configuration

10.1 Overview

All ADF models are equipped with a LAN (Ethernet) interface. As shipped, the unit automatically obtains an IP address from the network using the DHCP protocol. If the instrument is turned off for long periods, the IP address lease may expire and a new IP address will be assigned. If this is the case, it is possible to assign a fixed IP address instead.

10.2 Web Browser Interface

The ADF Series® conforms to the LXI (Lan eXtensions for Instrumentation) standard and as such as a built in web server. This allows communication with the ADF from any web browser as long as the ADF is on the same network.

Note: The ADF web server has been tested with Google Chrome and Mozilla Firefox browsers only. Microsoft Internet Explorer is now obsolete and is not supported. Other browser like Edge or Safari may not fully operate or display information correctly.

Note: Web server use from a browser is **not** supported in *UPC Compatibility* mode. Disable this mode when operating the ADF from a web browser.

Use the IP address shown in the LAN INTERFACE SETUP screen under the SYSTEM key to determine the IP address to type into the web browser.

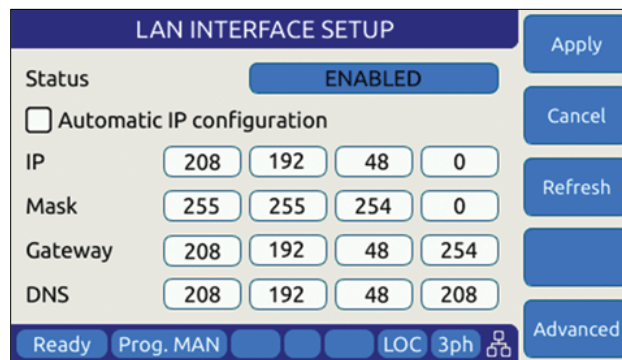

CAUTION: BEFORE USING BROWSER CONTROL

Verify that the level of remote access control is appropriate for the situation at hand. The power source is capable of producing lethal output voltage and operating it without being physically in the same room or space present a safety risks to others. Refer to 10.3.2, "Front Panel Access Control".

If the unit is on the same network or reachable through the internet, the home screen of the ADF web server will appear.

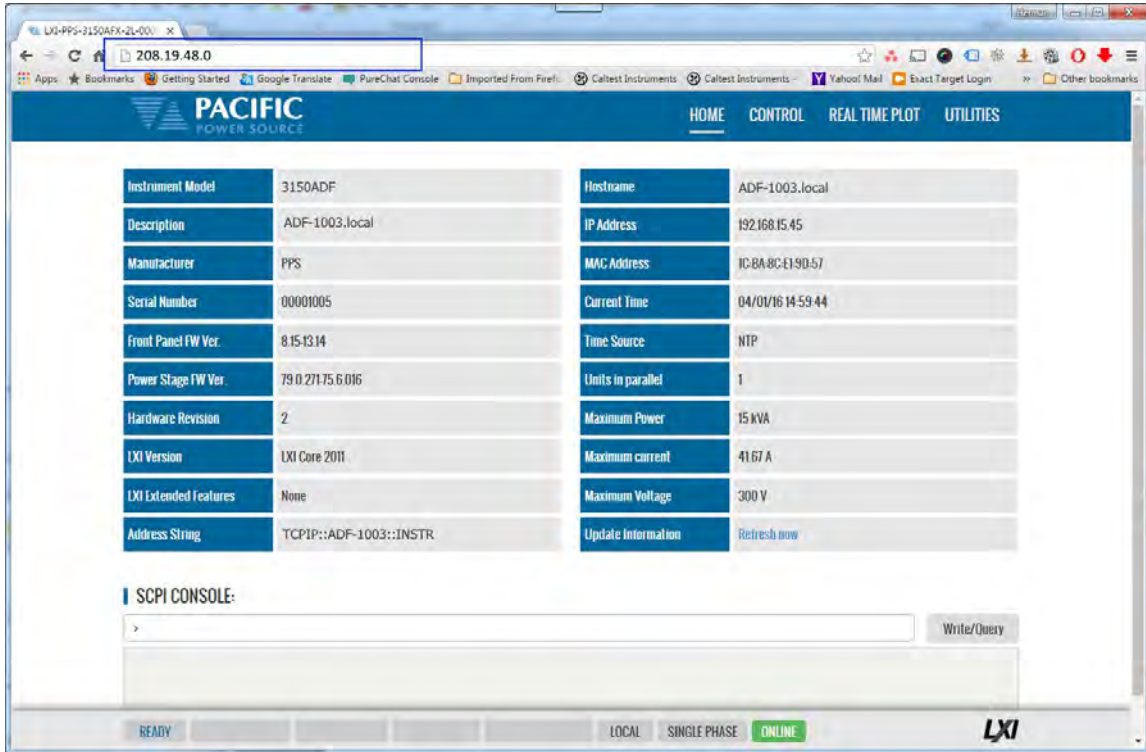

Figure 10-1: LXI Web Server Home Screen

When permitted, the browser interface allows monitoring of measurements and/or full control of the power source. If the operator is not near the actual instruments being controlled, care must be taken to the appropriate access control limits.

10.3 Access Control

Since the power source is capable of producing hazardous voltages at its output terminals, remote operation of the product over a LAN connection or any other available remote control interface can be restricted by the user to include only monitoring functions rather than full programming controls.

This feature is provided to ensure the safety of anyone near the unit in its actual physical location. This access control mechanism requires granting specific access to certain functions and features from the front panel by a person present at the location of the power source and requesting permission first trying to access a unit remotely.

These access control functions can be set from the SYSTEM Menu, INTERFACE screen or via the webserver using any browser.



WARNING

All ADF Units are shipped from the factory with ACCESS CONTROL **DISABLED. It is the instrument's owner's responsibility to enable these features.**

10.3.1 Browser Access Control

When connecting to the power source via a browser on which access has been restricted, the following message will appear:

The browser Access dialog is shown below.

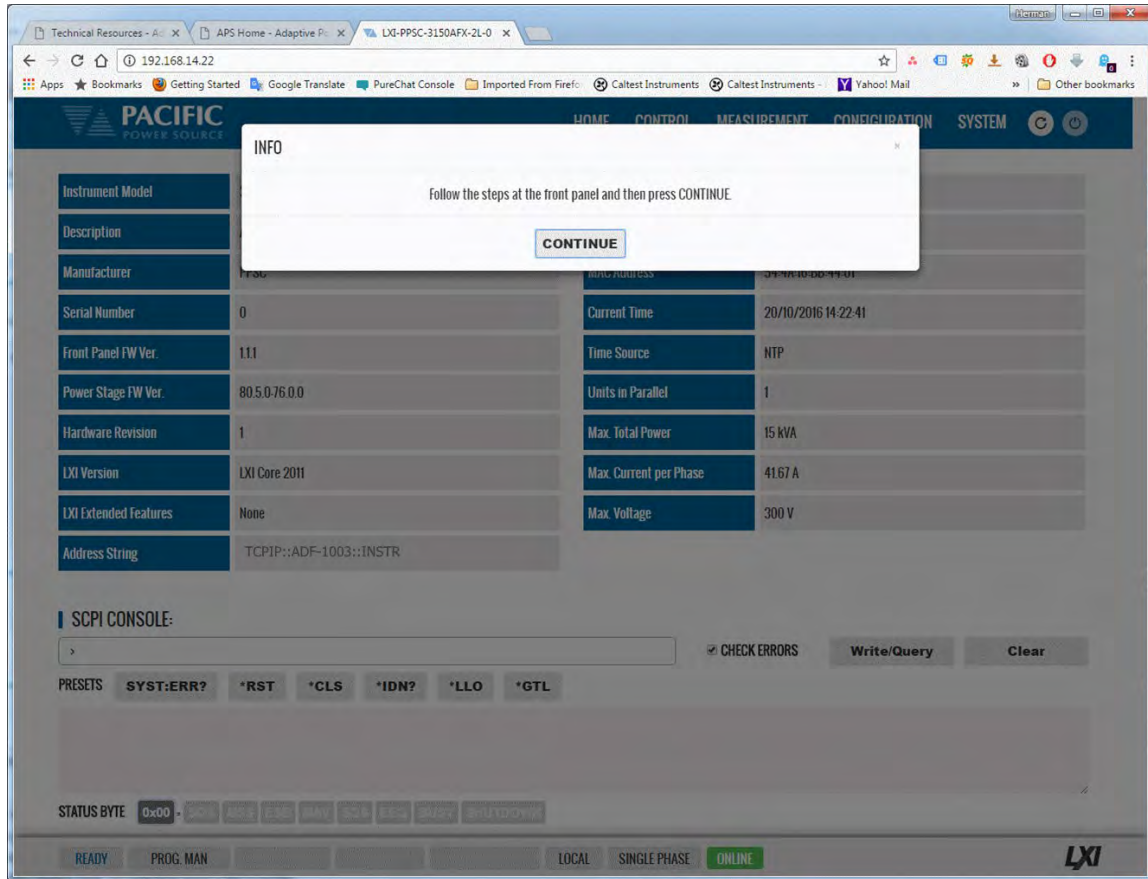

Figure 10-2: ACCESS CONTROL Dialog Screen

If the operator knows the four-digit access password that was set on the actual unit, he can enter the password code and gain full control of the source or Monitor⁶ only access depending on which mode was selected.

If the operator does not know the password, he can request access. Such a request can only be granted by a person who is in front of the actual unit however. This prevents unauthorized access from a remote location and protects the local user from possible harm. An Access Request will result in a Pop-Up message on the power source LCD screen.

The access control password can be set/changed only by the person(s) present at the physical location of the unit. Factory default password is “1234” but it is strongly **advised** the end user changes this to his own code after receipt of the unit.

If access is denied, the browser interface will enter MONITOR only mode in which measurements and settings can be viewed remotely but control is possible. When in this mode, a user with knowledge of the access password can enter FULL CONTROL mode by supplying the

⁶ Note: Monitor Only access mode requires firmware revision 3.6.44 or higher.

correct password or request full access from a local operator that is present at the unit’s location.

This dialog will appear when opening the browser interface while a unit is under ACCESS CONTROL and MONITOR mode is OFF (disabled).

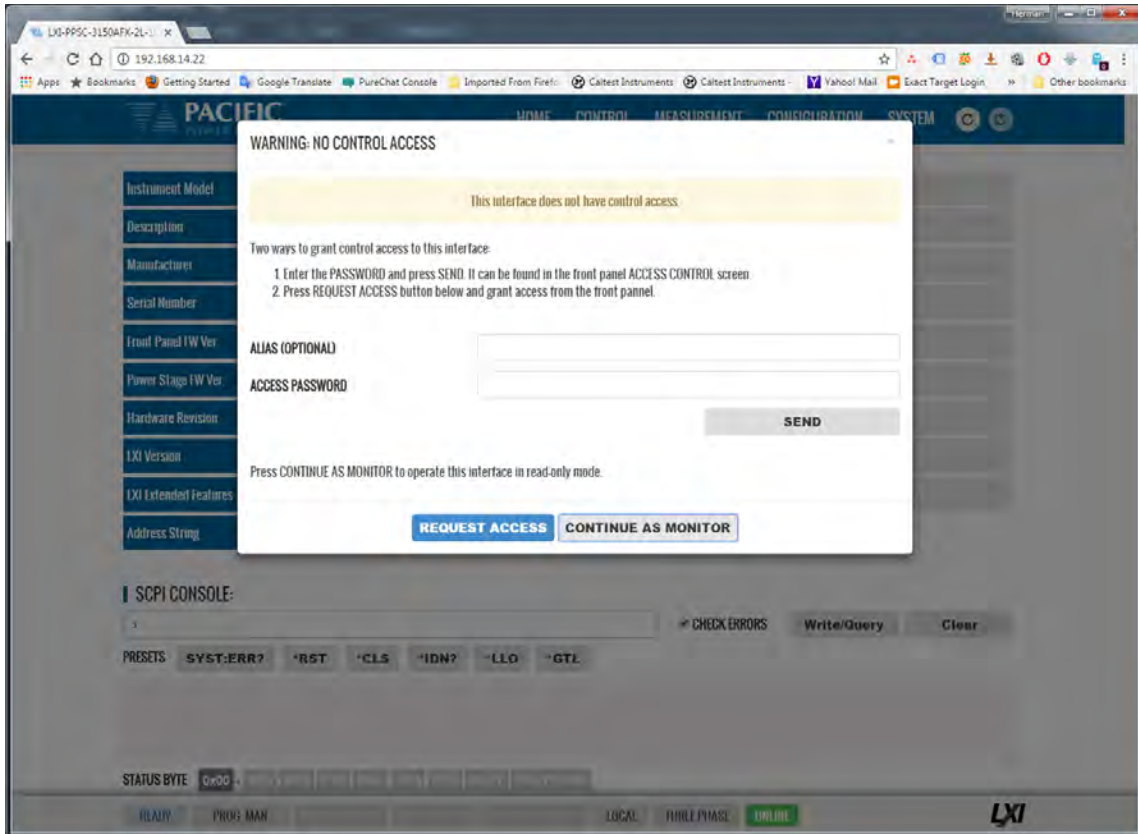

Clicking on “REQUEST ACCESS” will result in a dialog box appearing on the unit’s LCD screen displaying the requestor’s IP address. A message on the browser will indicate action is needed by the local operator. Now, the local operator can either DENY or GRANT access.

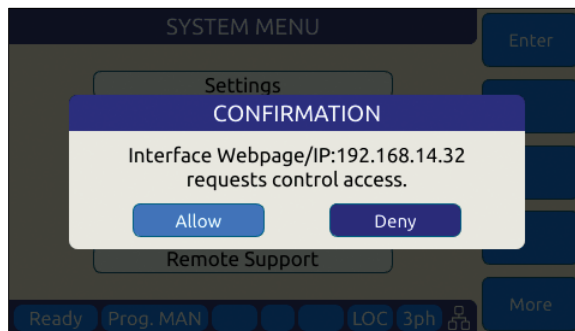
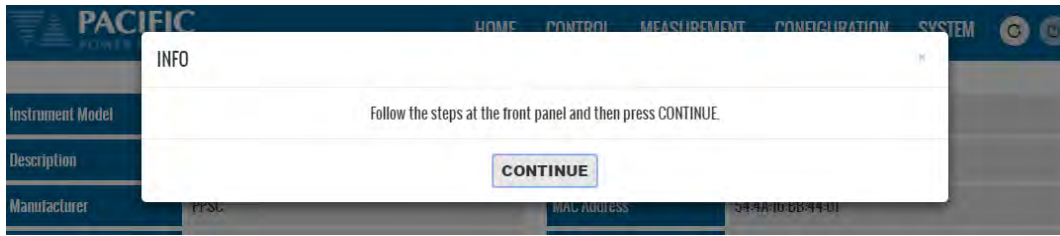

Figure 10-3: Remote Access Control Request Dialog

If remote access is granted, full control is provided. If denied, only monitoring is available.

Note: If the remote operator was given the ACCESS passcode, he can use it to gain access without a local operator’s intervention.



When granted, the requestor’s IP address will be added to the whitelist IP. The operator can remove any of the white listed IP address at any time if needed. This will lock out remote access for that PC until access is re-granted anew.

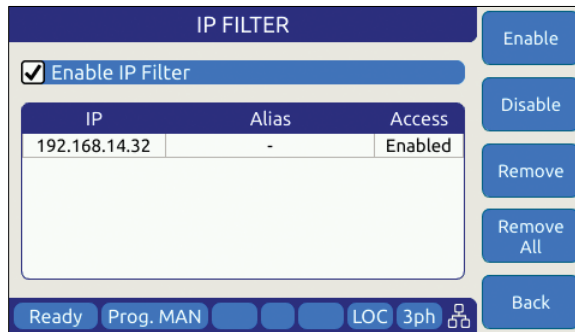
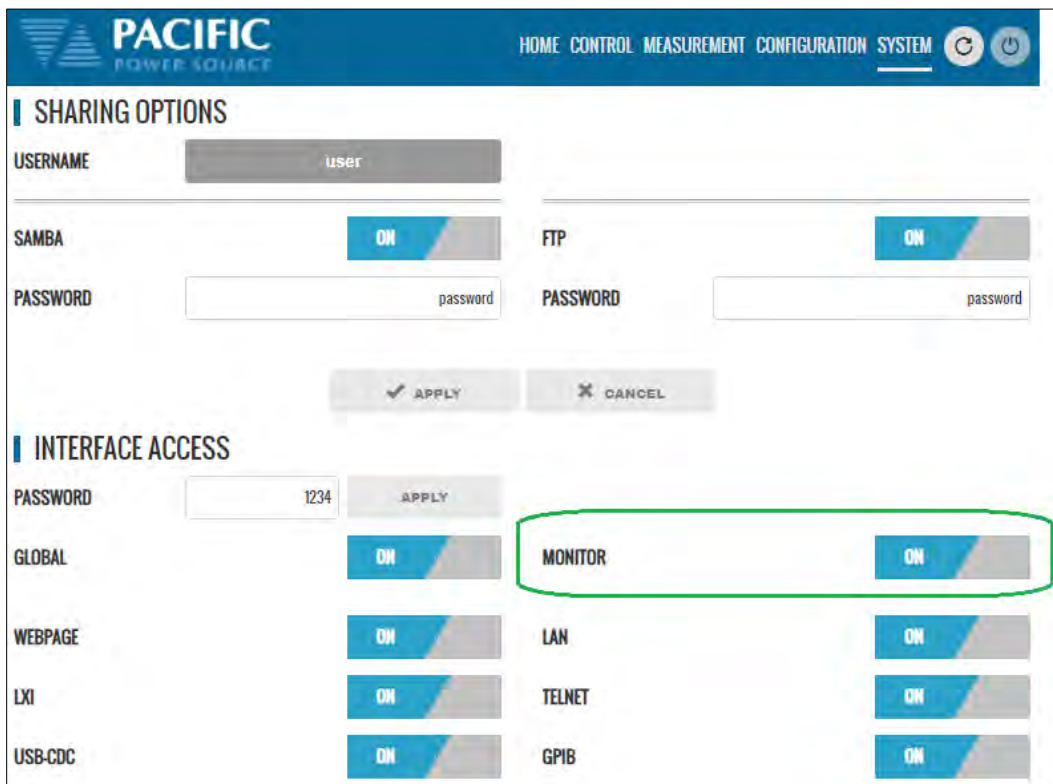
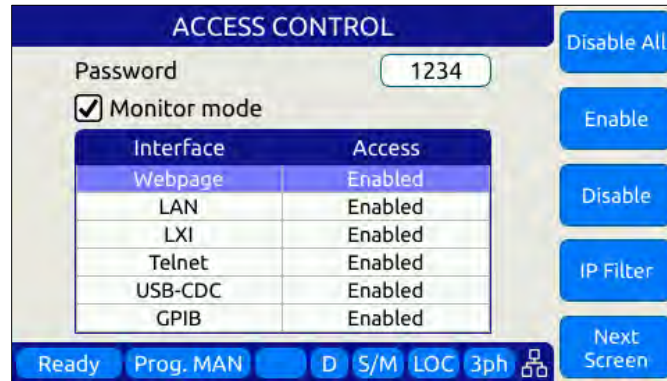

Figure 10-4: Remote Access Control IP Filter screen

Remote access can be configured from the System menu. To enable Monitor only mode, turn MONITOR on as shown below. In this mode, settings and measurements can be viewed but no changes can be made remotely.



Monitor mode can also be selected from the front panel using the System, Access Control screen as shown below.



If Monitor mode is disabled, the browser access control screen will look like this.

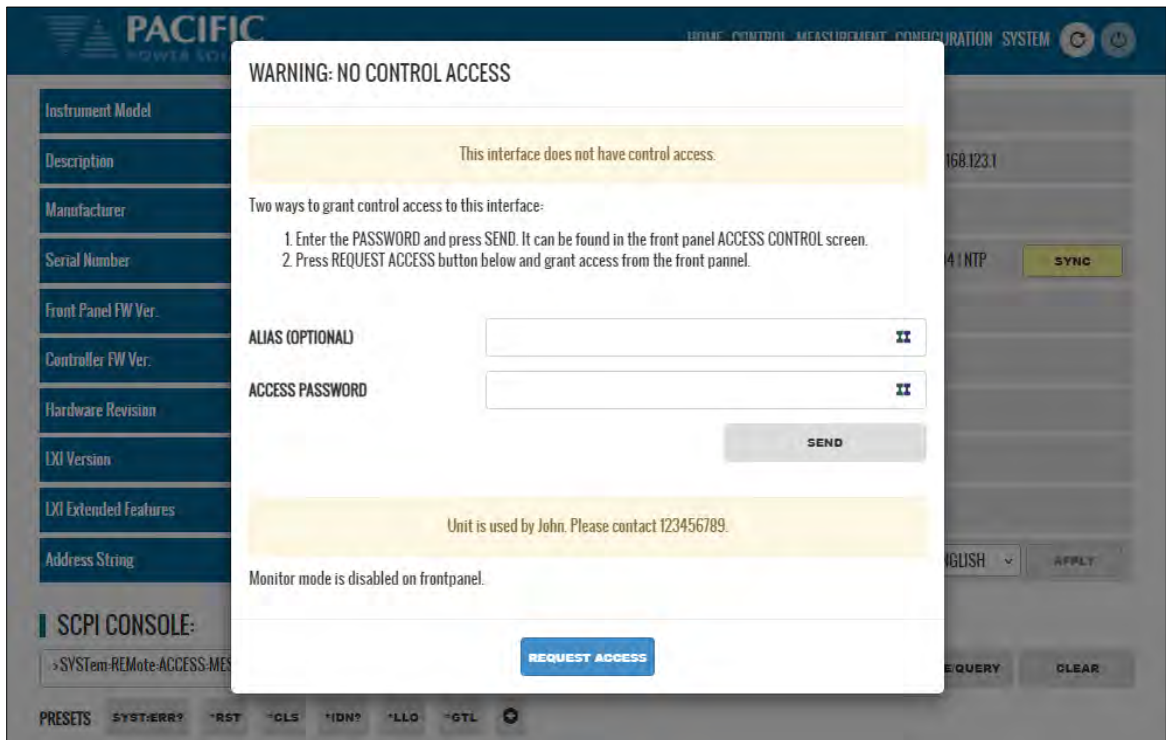

The message at the bottom of the screen can be set by the main user with the `SYSTEM:REMOte:ACCESS:MESSAge` SCPI command. In this example, the following command was used:
`SYSTEM:REMOte:ACCESS:MESSAge "Unit is used by John. Please contact 123456789."`

10.3.2 Front Panel Access Control

Setting remote control access levels and interface types is accomplished from the SYSTEM menu under Interfaces.

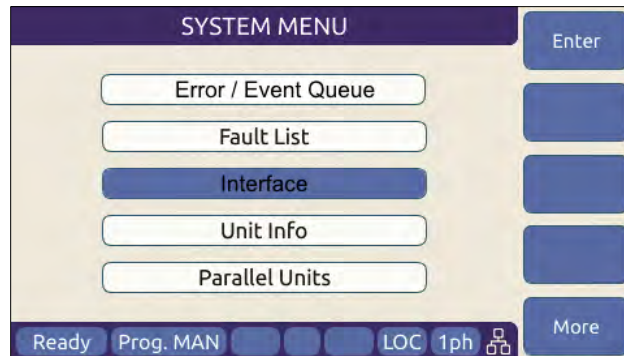

Scroll down to the INTERFACE entry and press Enter to access the available INTERFACE SETUP screen.

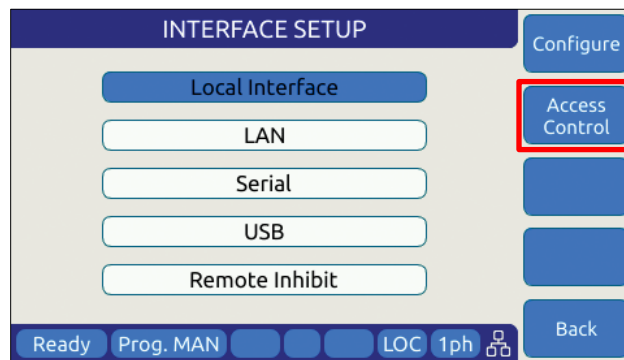

The second soft key is labelled “Access Control” and brings up the access control screen shown below.

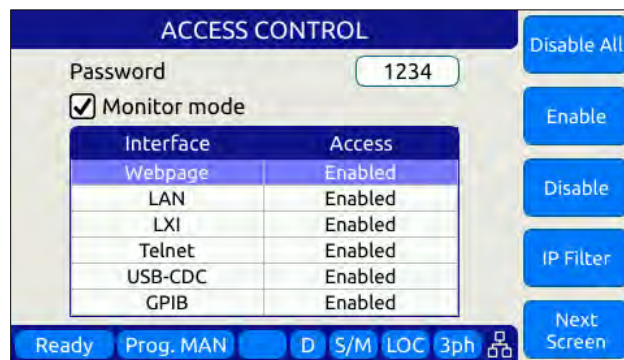

The IP Filter list will provide access to the list of IP addresses that have been granted access by the local operator. This list can be erased if it is necessary to deny future access to the power source.

10.4 Web Browser Interface

The ADF Series® conforms to the LXI (Lan eXtensions for Instrumentation) standard and features a built-in web server with a greatly expanded feature set. This allows communication with the ADF from any web browser as long as the ADF is reachable through the network or internet. The expanded feature set of the web server often eliminates the need to use additional Windows or other platform based software.

10.5 Available Web Interface Menu Tree

The following areas of control, monitoring and configuration of the ADF power source are available through a web browser.

- Home Screen – Required for LXI compliance
- Home Screen SCPI Console Command Line Interface
- SOURCE CONTROL
 - PROGRAM
 - PROTECTIONS
 - PROGRAM MEMORY
 - SCPI SCRIPT
- MEASUREMENTS
 - MONITOR
 - REAL TIME PLOT
 - V/I PLOT
 - DATALOGGER
- CONFIGURATION
 - UNIT SETTINGS
 - USER LIMITS & PRESETS
 - RAMP & SLEW
- SYSTEM
 - ERROR/EVENT QUEUE
 - FAULT LIST
 - INTERFACE SETUP
 - ACCESS CONTROL
 - DIGITAL & ANALOG IOS
 - UNIT INFORMATION
 - PARALLEL UNITS
 - MEMORY MANAGER
 - CALIBRATION
 - REMOTE SUPPORT
 - IMPORT/EXPORT
 - FIRMWARE UPDATE
 - SANITIZE & REBOOT

Following sections provide an overview of each page of the web browser interface.

10.6 Home Screen

The Home screen contains all required information relating to the instrument and its LAN connection as required by the LXI standard. This includes hardware and firmware revision information. The NTP clock **SYNC** button in the Current Time field is yellow if it detects that the date, time or zone is different than the computer, otherwise is in gray. Press the button to sync to the NTP time server.

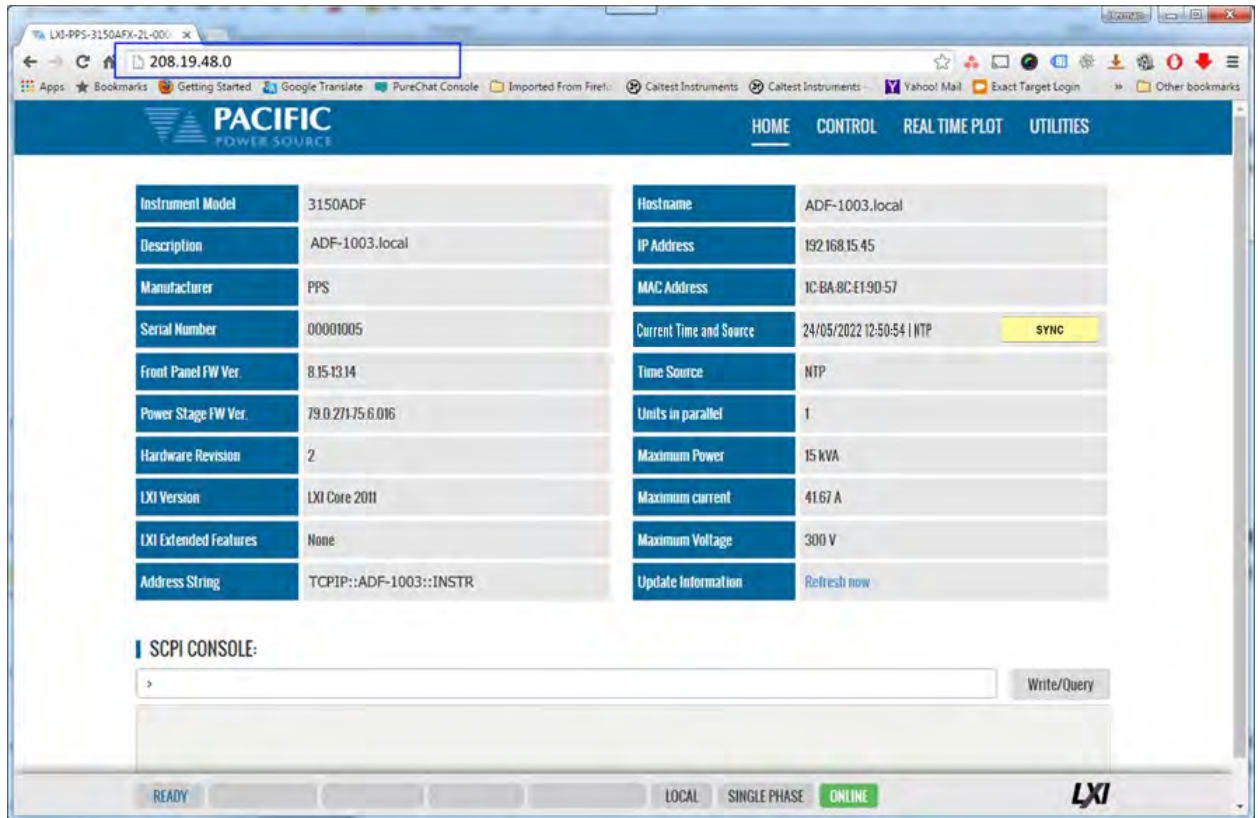

10.6.1 SCPI Console Command Line Interface

Near the bottom of the screen is an interactive command line interface that allows individual SCPI commands to be sent to the instrument. Any query results are shown in the text box below the command line. A drop-down list of all available commands is integrated in the command line and as you type a command, a match will be tracking in the drop down list allowing you to select the complete command without typing it out. See sample below after typing "SY".

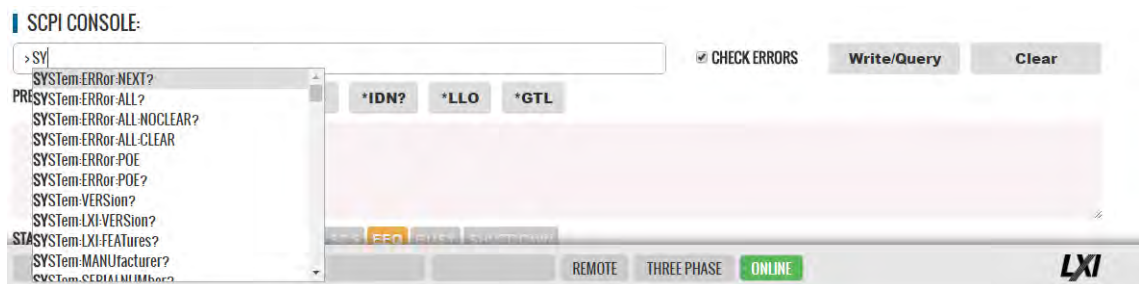

10.6.2 Status Byte Display

At the very bottom of the Home Screen, the status byte register value and decoded fields are displayed for reference. Status byte fields are described in section 8.12.1, “Status Byte Register (STB)” on page 295.

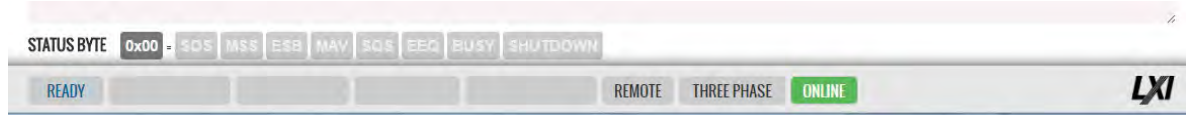

10.6.3 Browser Status Bar

The browser status bar shows configuration information about the instrument. This includes any error or event flags, remote or local status, phase mode selection and on or off line status.



The first field will display **READY** while the power source output is OFF and **ENABLED** when it is ON (enabled).

10.6.4 Operation Manual PDF

The ADF Operation Manual is stored on the ADF’s internal memory and available for download to the user’s PC (“Download”) or for viewing using a suitable browser of PDF viewer (“View”).

PACIFIC POWER SOURCE				HOME	CONTROL	MEASUREMENT	CONFIGURATION	SYSTEM	⊙	⏻
Instrument Model	3150ADF	Hostname	ADF-105624006.local							
Description	ADF-105624006	IP Address	192.168.26.29							
Manufacturer	PPSC	MAC Address	54-4A-16-BB-40-09							
Serial Number	105624006	Current Time	30/01/2017 15:16:13							
Front Panel FW Ver.	1.3.5	Time Source	NTP							
Power Stage FW Ver.	80.7.0-76.0.0	Units in Parallel	1							
Hardware Revision	0	Max. Total Power	15 kVA							
LXI Version	LXI Core 2011	Max. Current per Phase	41.67 A							
LXI Extended Features	None	Max. Voltage	300 V							
Address String	TCP/IP::ADF-105624006::INSTR	Operation Manual	View - Download							

10.7 Source Control Screens

The CONTROL menu provides access to several screens that allow programming of the power source. Control Menu entries are as follows:

- PROGRAM
- PROTECTIONS
- PROGRAM MEMORY
- SCPI SCRIPT

Each is described in subsequent sections.

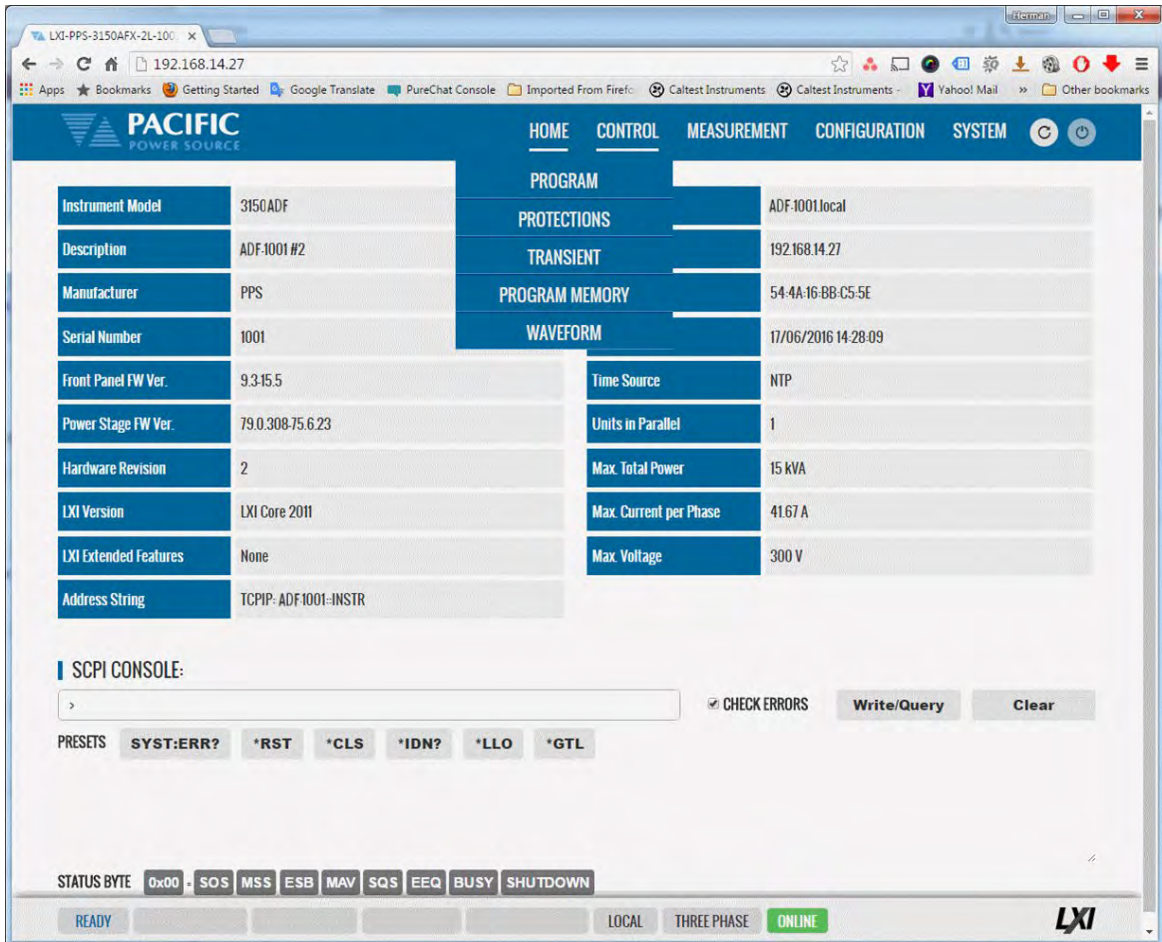

The screenshot shows the Pacific Power Source web interface. The top navigation bar includes HOME, CONTROL, MEASUREMENT, CONFIGURATION, and SYSTEM. The CONTROL menu is expanded, showing options for PROGRAM, PROTECTIONS, TRANSIENT, PROGRAM MEMORY, and WAVEFORM. The main content area displays system information in two columns:

Instrument Model	3150ADF	PROGRAM	ADF:1001.local
Description	ADF:1001 #2	PROTECTIONS	192.168.14.27
Manufacturer	PPS	TRANSIENT	54-4A-16-BB-C5-5E
Serial Number	1001	PROGRAM MEMORY	17/06/2016 14:28:09
Front Panel FW Ver.	9.3.15.5	WAVEFORM	
Power Stage FW Ver.	79.0.308.75.6.23	Time Source	NTP
Hardware Revision	2	Units in Parallel	1
LXI Version	LXI Core 2011	Max. Total Power	15 kVA
LXI Extended Features	None	Max. Current per Phase	41.67 A
Address String	TCPIP: ADF:1001-INSTR	Max. Voltage	300 V

Below the system information is the SCPI CONSOLE section, which includes a text input field, a "CHECK ERRORS" checkbox, and buttons for "Write/Query" and "Clear". There are also several preset buttons: SYST:ERR?, *RST, *CLS, *IDN?, *LLO, and *GTL.

At the bottom, the STATUS BYTE is displayed as 0x00, and the system is shown as READY, LOCAL, THREE PHASE, and ONLINE. The LXI logo is visible in the bottom right corner.

10.7.1 Program

The program control screen allows programming of all output parameters, operating modes etc. It also displays measurement data for all available phases in the lower part of the screen. In three or two phase mode, Line-to-Line voltage measurements are displayed at the bottom of the screen. The Output can be enabled using the “OUTPUT ENABLE” controls in the upper PROGRAM screen. The Output can also be turned **OFF** from any screen using the RED On/Off symbol in the menu bar, which is accessible from all screens. This allows quick opening of the output relay if needed from any screen without have to first select the PROGRAM screen. Note that the output can only be turned **ON** (or OFF) from the PROGRAM screen however.

The screenshot shows the Pacific Power Source web interface. The top navigation bar includes 'HOME', 'CONTROL', 'MEASUREMENT', 'CONFIGURATION', 'SYSTEM', and a power button icon (a circle with a power symbol) which is highlighted with a red box and a red arrow. The main content area is titled 'PROGRAM' and features an 'OUTPUT ENABLE' section with 'ON' selected. Below this are controls for 'FREQUENCY' (400.00 Hz), 'AC VOLTAGE' (95.00 V_{RMS}), and 'DC VOLTAGE' (0.00 V_{DC}). To the right, the 'SELECTED PHASE' is set to 'ABC', and there are controls for 'CURRENT LIMIT' (4167 A_{RMS}), 'POWER LIMIT' (5.0000 kW), and 'KVA LIMIT' (5.0000 kVA). An 'APPLY' button is visible. The lower section, 'MEASUREMENTS', displays a table of data for three phases (A, B, C).

	Phase A	Phase B	Phase C
FREQUENCY	400.00 Hz	400.00 Hz	400.00 Hz
VOLTAGE L-N AC/DC	103.62 V _{RMS}	125.20 V _{RMS}	67.76 V _{RMS}
VOLTAGE L-N AC	103.62 V _{RMS}	125.20 V _{RMS}	67.76 V _{RMS}
VOLTAGE L-N DC	0.00 V _{DC}	0.00 V _{DC}	0.00 V _{DC}
CURRENT RMS	17.48 A _{RMS}	21.16 A _{RMS}	11.51 A _{RMS}
CURRENT DC	0.80 A _{DC}	0.69 A _{DC}	-0.74 A _{DC}
POWER	1.8062 kW	2.6433 kW	0.0000 kW
APP POWER	1.8116 kVA	2.6492 kVA	0.7797 kVA
POWER FACTOR	1.00	1.00	-
CURRENT CF	1.46	1.45	1.48
	V _{AB}	V _{BC}	V _{CA}
VOLTAGE L-L AC/DC	198.46 V _{RMS}	169.56 V _{RMS}	198.46 V _{RMS}
VOLTAGE L-L AC	198.46 V _{RMS}	169.56 V _{RMS}	198.46 V _{RMS}
VOLTAGE L-L DC	0.00 V _{RMS}	0.00 V _{RMS}	0.00 V _{RMS}

At the bottom of the interface, there are status indicators: 'ENABLED', 'VOLTAGE MODE', 'REMOTE', 'THREE PHASE', and 'ONLINE'. The LXI logo is also present in the bottom right corner.

10.7.2 Protections

The Protections screen may be used to change protection modes and threshold values. This includes RMS current, Peak Current, True Power and Apparent Power protection modes. Modes can be toggled on or off individually.

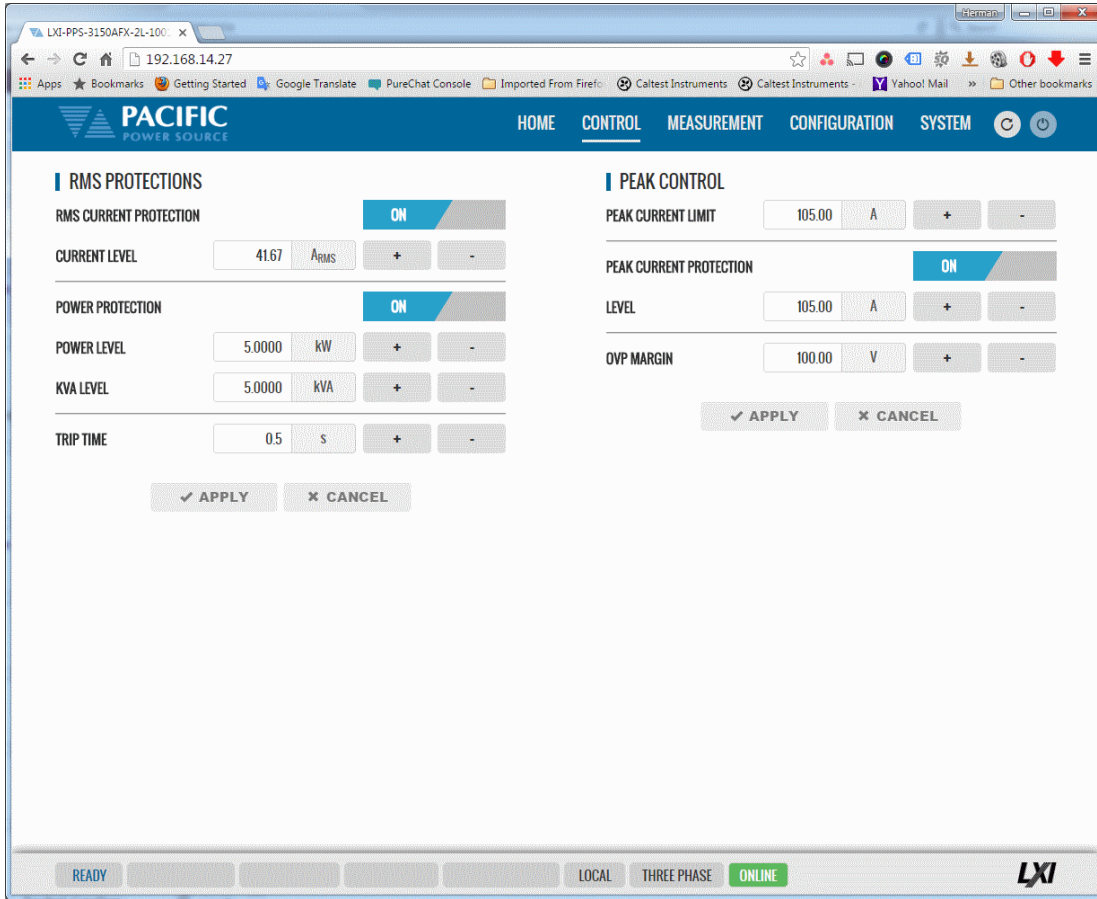

10.7.3 Program Memory

Program settings and transients can be stored in a number of different memory types. The Program Memory screen allows the user to manage available stored programs. The program to be recalled on power up can be selected at the bottom of this screen in the “POWER ON PROGRAM” area.

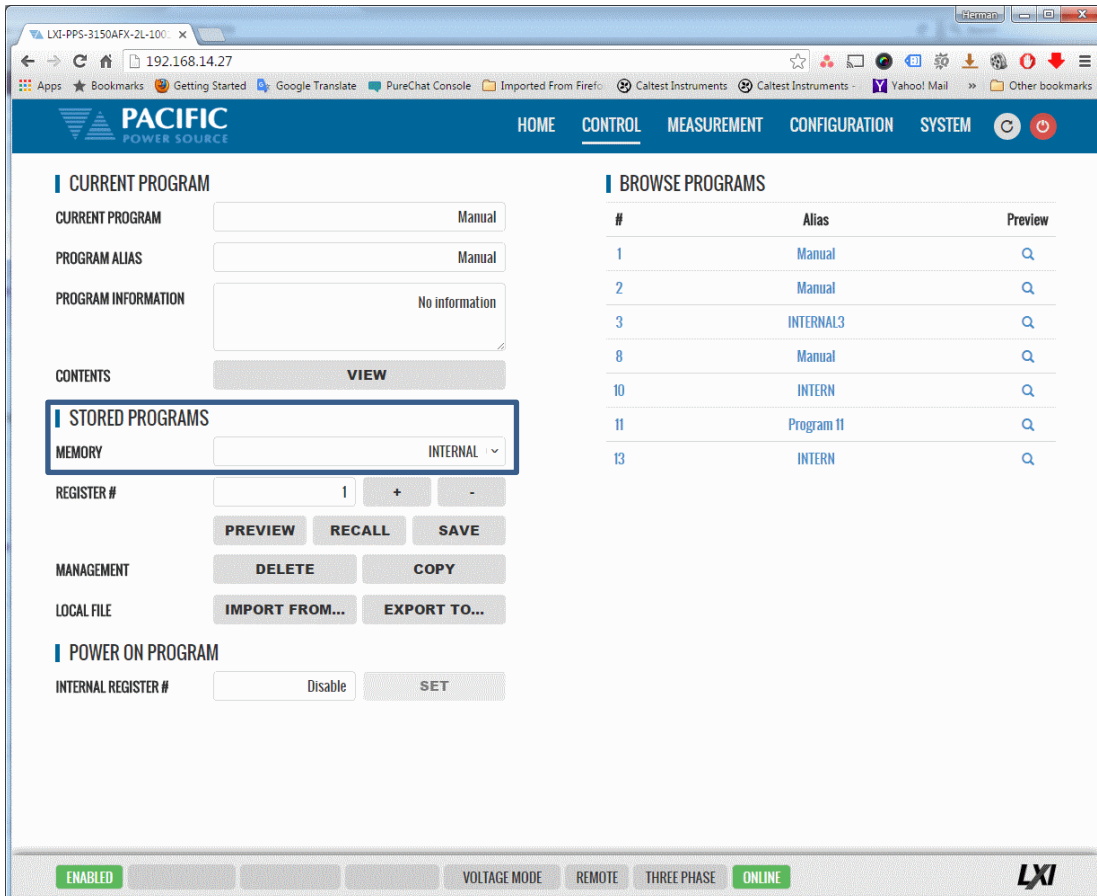

Note that external storage devices may be selected under “**STORED PROGRAMS**” using the MEMORY drop down list control.

10.7.4 SCPI Script

The SCPI Script menu entry displays the command scripting screen. These user generated scripts can contain any sequence of SCPI commands, comments and output statements to automate simple repetitive tasks. Scripts may be used to automate repetitive tasks more quickly and are simpler to write than an actual application program.

A script can be saved to the PC or tablet on which the browser runs.

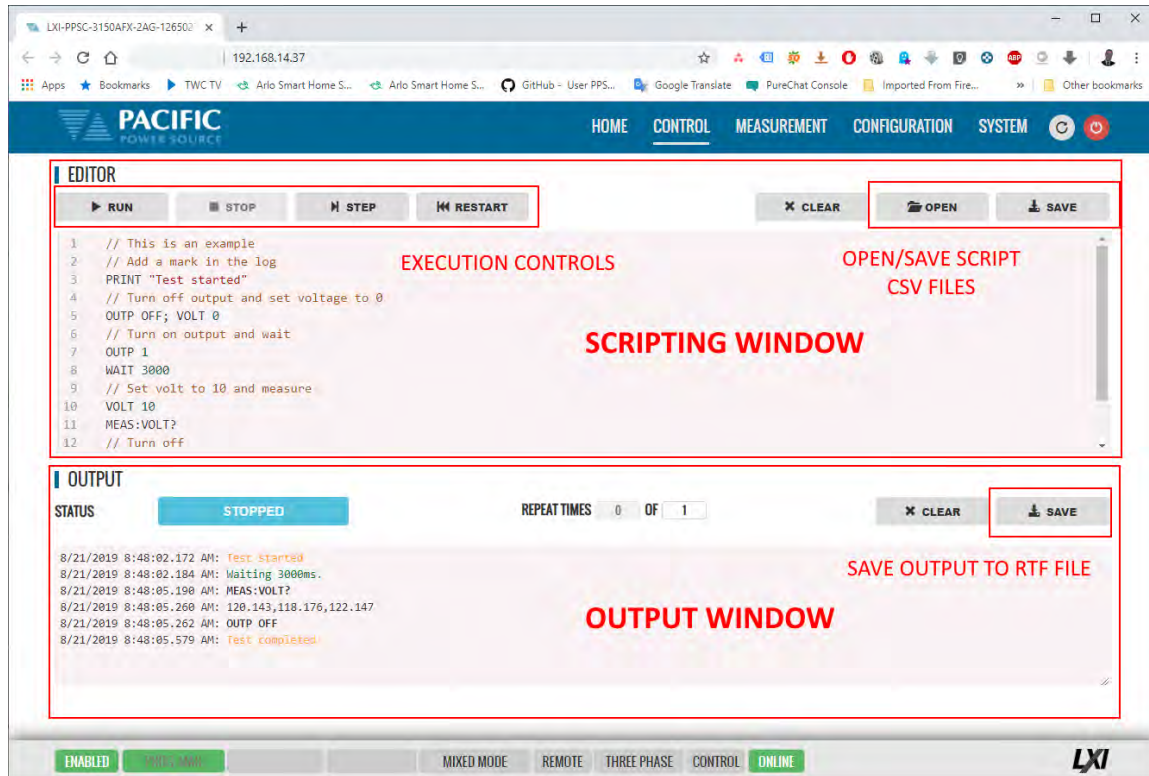

10.7.4.1 Supported Keywords and Commands

The following script entries are supported:

Entry Type	Description
USER COMMENT	// Any test preceded by a two forward slash characters
PRINT	Sends text strings after PRINT key word to the OUTPUT window located at the bottom half of the browser window.
WAIT	Pauses script execution by no of msec specified.
SCPI COMMAND	Any support SCPI command. Data returned by a query command (?) will be printed in the output window.

Table 10-1: Supported Script Entries

10.7.4.2 Script Execution Control

To run a script, click the ► **RUN** button in the upper left corner of the Editor window. You can also single step through a script during development using the ► | **STEP** button. The ■ **STOP** button will abort execution of a running script. To run a script multiple times, set the REPEAT TIMES value to a value higher than the default 1 (one). Max. repeat count is TBD.

10.7.4.3 Managing multiple script files.

Script files can be saved to the PC or device on which the browser runs, i.e. Windows PC, Tablet, or Smartphone. Use the **OPEN** and **SAVE** buttons in the upper right corner of the Editor window to save and retrieve scripts. Scripts are saved in Comma Separated File format, which can be edited in Excel or any text editor like Notepad. The sample script csv file content (*scpi_script.csv*) is shown below. When saving a new script, replace the default scpi_script file name with a more descriptive file name.

```
// Available commands are:  
// - WAIT MILLISECONDS, example -> WAIT 2000  
// - PRINT "TEXT", example -> PRINT "Test started"  
// - SCPI COMMAND/s, example -> OUTP OFF; VOLT 0  
// Comments starts with // as this line  
// The following is an example  
// Add a mark in the log  
PRINT "Test started"  
// Turn off output and set voltage to 0  
OUTP OFF; VOLT 0  
// Turn on output  
OUTP 1  
// Wait three seconds  
WAIT 3000  
// Set output voltage to 10 volts  
VOLT 10  
// Get output voltage measurement  
MEAS:VOLT?  
// Turn off  
OUTP OFF  
PRINT "Test completed"
```

10.7.4.4 "Script Execution Output

The OUTPUT window located in the bottom half of the browser window shows all script output, including any user comments, events like script start and stop as well as any PRINT commands. Each output entry is date and time stamped.

The content of the **OUTPUT** window can be saved to a Rich Text File using the **SAVE** button in the upper right corner of the OUTPUT window. (Do not confuse with the SAVE button in the script EDITOR window.) The default output file name is "*scpi_script_output.rtf*". A sequence number (1), (2) etc will be appended each time the output window content is saved.

A sample RFT file is shown below.

```
8/21/2019 8:48:02.172 AM: Test started  
8/21/2019 8:48:02.184 AM: Waiting 3000ms.  
8/21/2019 8:48:05.190 AM: MEAS:VOLT?  
8/21/2019 8:48:05.260 AM: 120.143,118.176,122.147  
8/21/2019 8:48:05.262 AM: OUTP OFF  
8/21/2019 8:48:05.579 AM: Test completed
```

Note: All output files are saved to the default Download directory determined by the Browser setting.

10.8 Measurement Screens

The MEASUREMENT menu provides access to several measurement screens. Measurement screens available are:

- MONITOR
- REAL TIME PLOT
- V/I PLOT
- DATALOGGER

Each is described in subsequent sections.

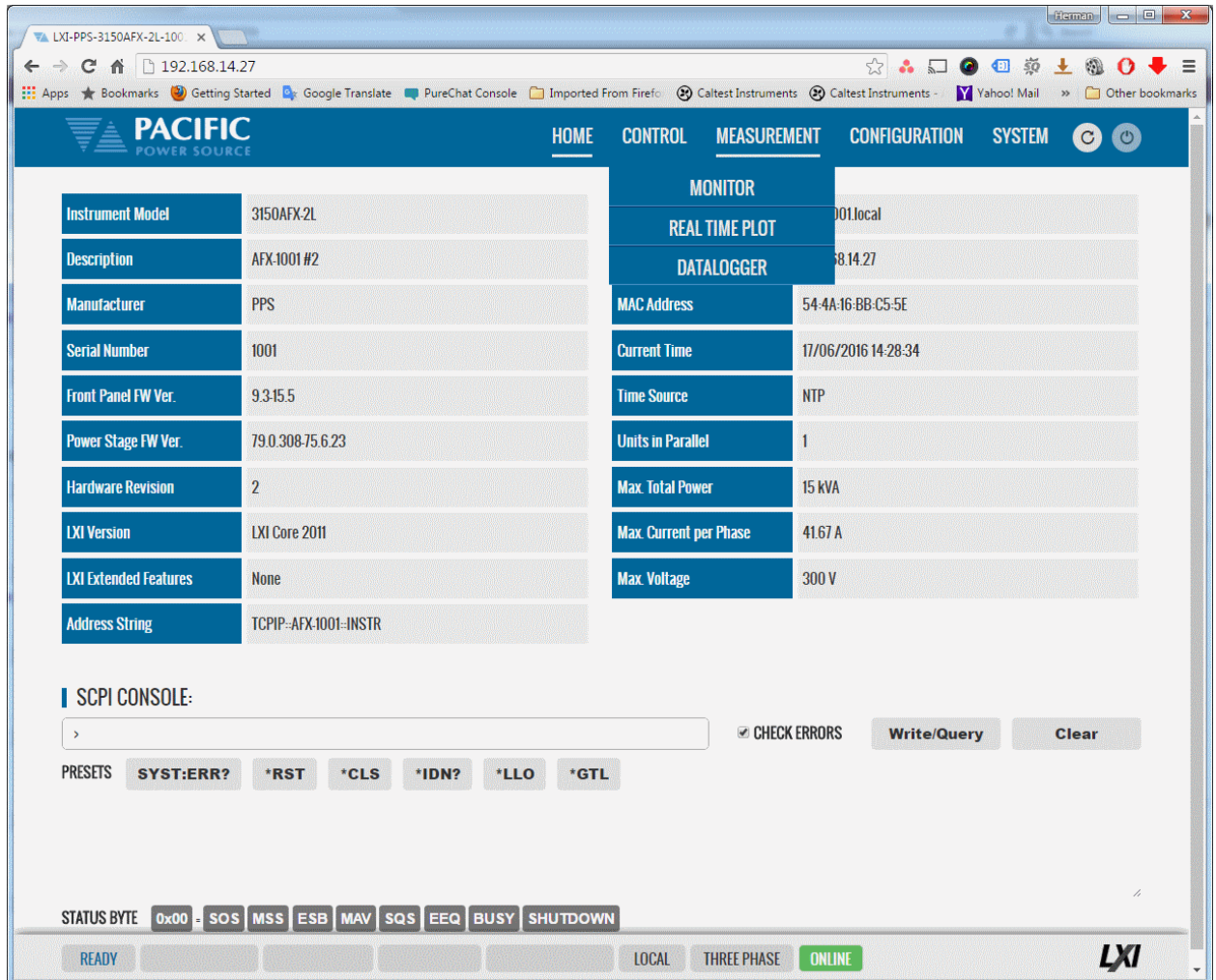

The screenshot shows the web interface for the LXI-PPS-3150AFX-2L-100 power source. The browser address bar shows the IP address 192.168.14.27. The navigation menu includes HOME, CONTROL, MEASUREMENT, CONFIGURATION, and SYSTEM. The MEASUREMENT menu is expanded, showing sub-options: MONITOR, REAL TIME PLOT, and DATALOGGER. The MONITOR screen displays the following information:

Instrument Model	3150AFX2L
Description	AFX-1001 #2
Manufacturer	PPS
Serial Number	1001
Front Panel FW Ver.	9.3.15.5
Power Stage FW Ver.	79.0.308.75.6.23
Hardware Revision	2
LXI Version	LXI Core 2011
LXI Extended Features	None
Address String	TCPIP::AFX-1001-INSTR

Additional system information displayed on the right side of the MONITOR screen:

MAC Address	54-4A-16-BB-C5-5E
Current Time	17/06/2016 14:28:34
Time Source	NTP
Units in Parallel	1
Max. Total Power	15 kVA
Max. Current per Phase	41.67 A
Max. Voltage	300 V

Below the instrument details is the SCPI CONSOLE section, which includes a text input field, a "CHECK ERRORS" checkbox, and buttons for "Write/Query" and "Clear". There are also "PRESETS" buttons for *SYS:ERR?, *RST, *CLS, *IDN?, *LLO, and *GTL.

At the bottom, the STATUS BYTE is shown as 0x00, and the system status is displayed as READY, LOCAL, THREE PHASE, and ONLINE. The LXI logo is visible in the bottom right corner.

10.8.1 Monitor

The measurement monitor screen replicates part of the CONTROL->PROGRAM screen and displays all measurement data for all available output phases. Measurements include both AC and DC components.

Note: There are no controls on this screen.

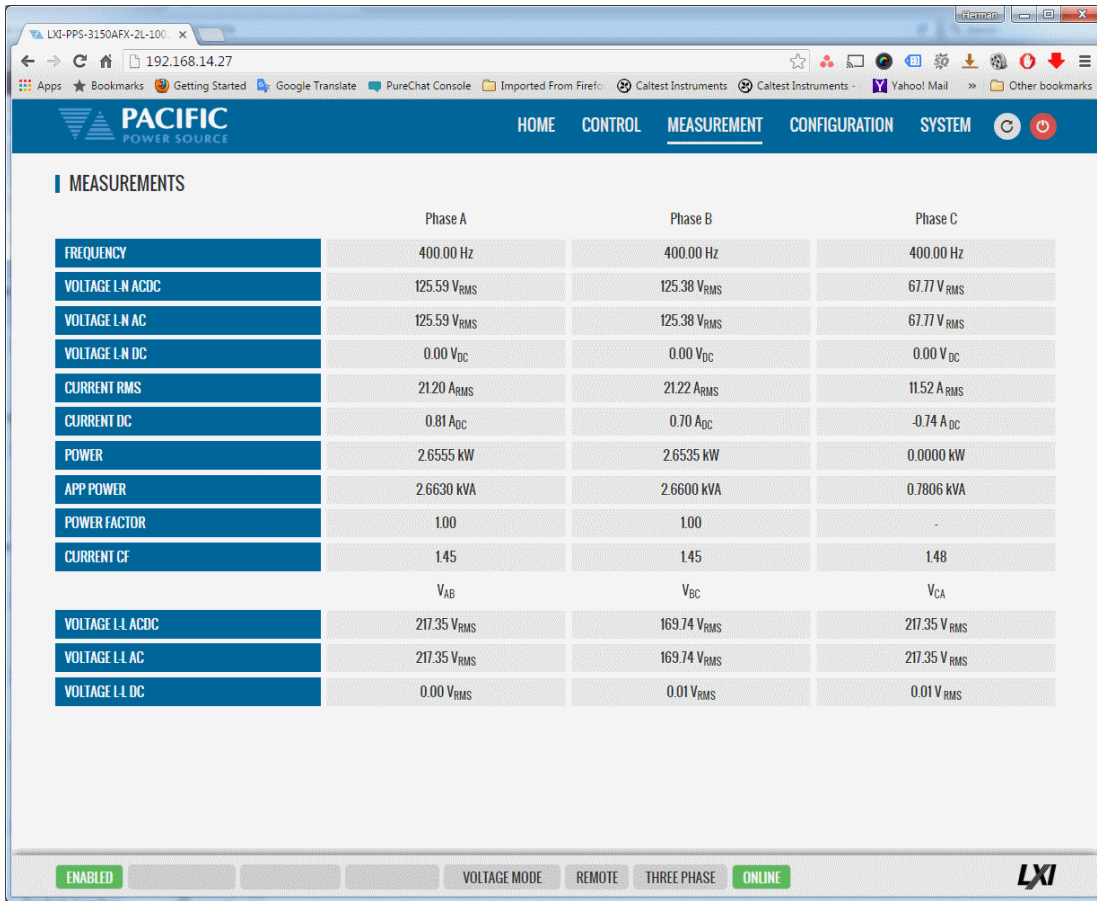

	Phase A	Phase B	Phase C
FREQUENCY	400.00 Hz	400.00 Hz	400.00 Hz
VOLTAGE L-N ACDC	125.59 V _{RMS}	125.38 V _{RMS}	67.77 V _{RMS}
VOLTAGE L-N AC	125.59 V _{RMS}	125.38 V _{RMS}	67.77 V _{RMS}
VOLTAGE L-N DC	0.00 V _{DC}	0.00 V _{DC}	0.00 V _{DC}
CURRENT RMS	21.20 A _{RMS}	21.22 A _{RMS}	11.52 A _{RMS}
CURRENT DC	0.81 A _{DC}	0.70 A _{DC}	-0.74 A _{DC}
POWER	2.6555 kW	2.6535 kW	0.0000 kW
APP POWER	2.6630 kVA	2.6600 kVA	0.7806 kVA
POWER FACTOR	1.00	1.00	-
CURRENT CF	1.45	1.45	1.48
	V _{AB}	V _{BC}	V _{CA}
VOLTAGE L-L ACDC	217.35 V _{RMS}	169.74 V _{RMS}	217.35 V _{RMS}
VOLTAGE L-L AC	217.35 V _{RMS}	169.74 V _{RMS}	217.35 V _{RMS}
VOLTAGE L-L DC	0.00 V _{RMS}	0.01 V _{RMS}	0.01 V _{RMS}

ENABLED VOLTAGE MODE REMOTE THREE PHASE ONLINE LXI

10.8.2 Real-Time Plot

This measurement screens provides a strip-chart style graphical display for up to two measurement parameters, #1 and #2. The CONTROLS are allows selection of the desired parameter for each graph. Available choices are Voltage, Current and Power. Depending on phase mode, up to three phase values are displayed per chart.

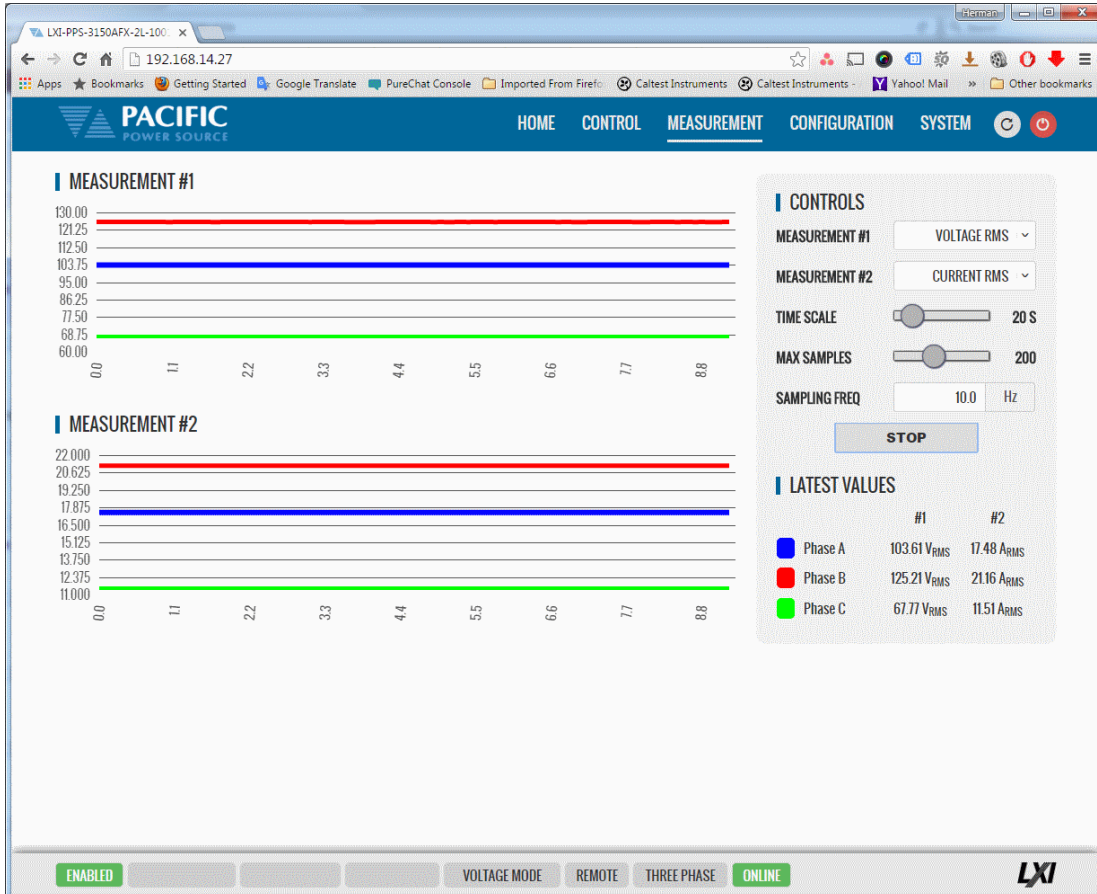

10.8.3 V/I Plot

The V/I plot shows the power operating point at any moment in time by plotting measured Voltage as a function of measured Current. This plot has a persistence mode so the user can observe power fluctuations and changes over a set period.

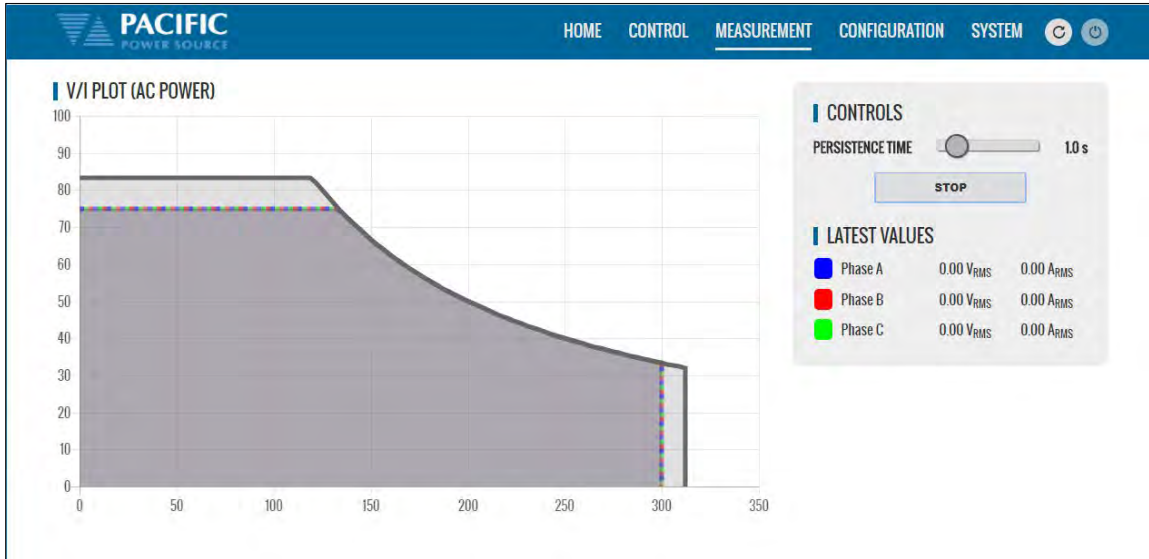

Available selections in this measurement screen are:

- Persistence Time: 1 ~ 60 sec

10.8.4 Data Logger

The measurement data logger screen allows measurement data to be written to a memory device, using a comma delimited file format. These files are easy to open in an Excel™ spreadsheet or other math oriented software program.

Available controls are for State on/off, memory destination device, file name assignment and data logging rate in Hz. All file entries are time stamped.

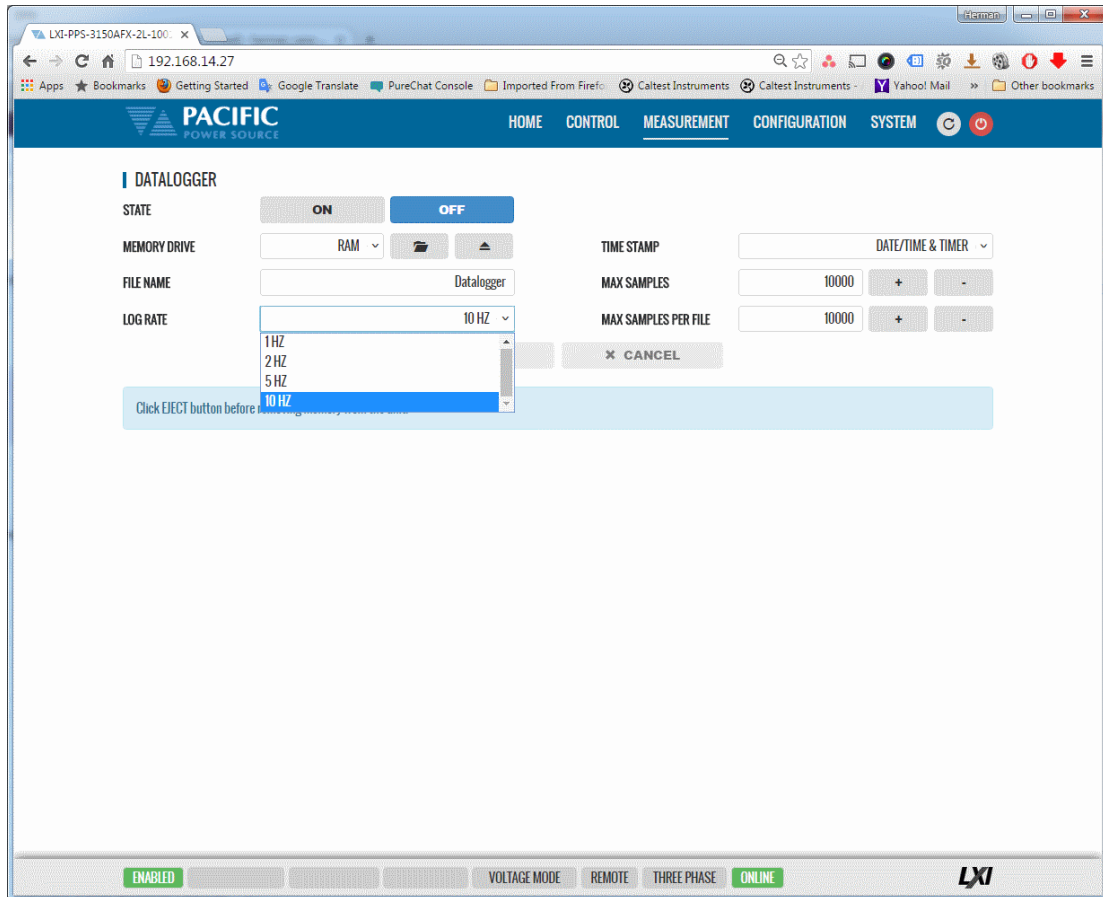

10.9 Configuration Screens

The CONFIGURATION menu provides access to secondary power source settings that are less frequently changed than those on the PROGRAM screen. Configuration screens available are:

- UNIT SETTINGS
- USER LIMITS & PRESETS
- RAMP & SLEW

Each is described in subsequent sections.

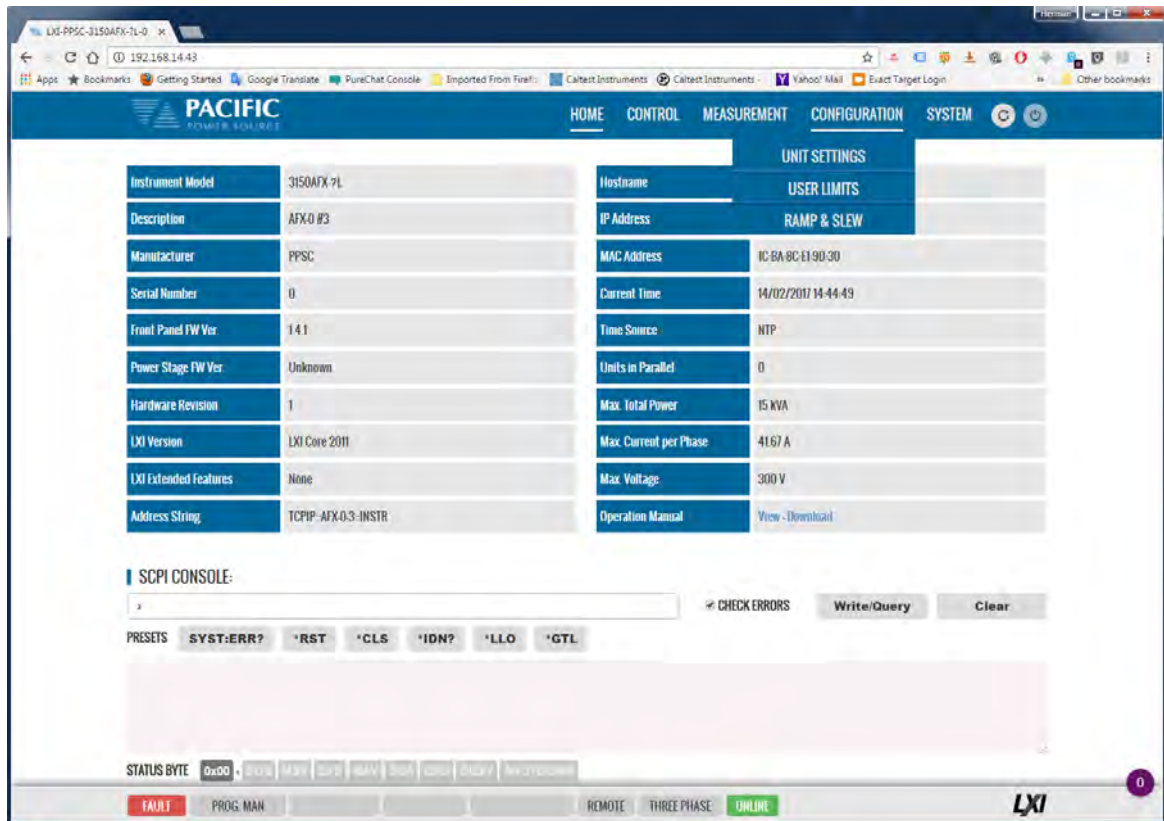

Instrument Model		Unit Settings	
Instrument Model	3150AFX 7L	Hostname	USER LIMITS
Description	AFX-0 #3	IP Address	RAMP & SLEW
Manufacturer	PPSC	MAC Address	IC BA-8C-E1-90-30
Serial Number	0	Current Time	14/02/2017 14:44:43
Front Panel FW Ver	1.4.1	Time Source	NTP
Power Stage FW Ver	Unknown	Units in Parallel	0
Hardware Revision	1	Max. Total Power	15 KVA
LXI Version	LXI Core 2011	Max. Current per Phase	41.67 A
LXI Extended Features	None	Max. Voltage	300 V
Address String	TCP/IP-AFX-0-3-INSTR	Operation Manual	View - Download

SCPI CONSOLE:

PRESETS: **SYST:ERR?** *RST *CLS *IDN? *LLO *GTL

STATUS BYTE: 0x00 0x03 0x00 0x00 0x00 0x00 0x00 0x00 0x00 0x00 0x00 0x00 0x00 0x00 0x00 0x00

FAULT PROG MAN REMOTE THREE PHASE ONLINE LXI

10.9.1 Unit Settings

Unit settings determine the mode of operation of the power source. This includes phase mode, voltage range, output mode, update phase angle and ramp time for any output value changes made.

- Output enable at power on allows the unit to power up with the output enabled.
- The Enable Current Overload setting allows short duration overloads up to 30% over the normal continuous mode current limit set point.
- Phase Rotation selection changes output phasing between positive (leading) and negative (lagging) phase rotation in three phase output mode.
- The maximum adjustment limit for continuous self-calibration mode and fault generation on saturation can be set from this screen as well.
- The right hand side of the screen contains Transient mode execution settings.
- Language selections are either ENGLISH or CHINESE.

These can all be set from the CONFIGURATION -> UNIT SETTINGS screen shown below.

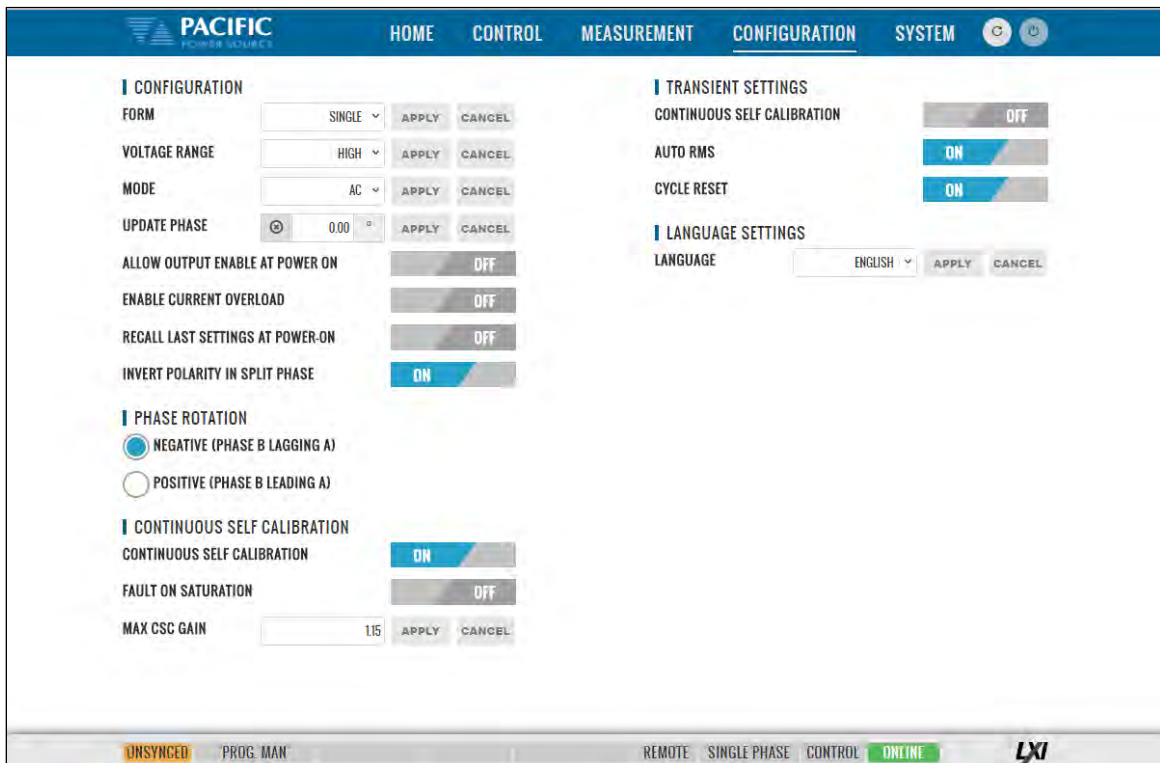

10.9.2 User Limits & Presets

User limits can be used to minimize operator error by setting upper and/or lower limits on programmable parameter ranges.

Limits can be set for Voltage AC Voltage and Frequency.

Note: When changing user limits, make sure programmed parameter settings in effect are not outside the new upper and lower limits entered.

All user limits can be set from the CONFIGURATION -> USER LIMITS screen shown below.

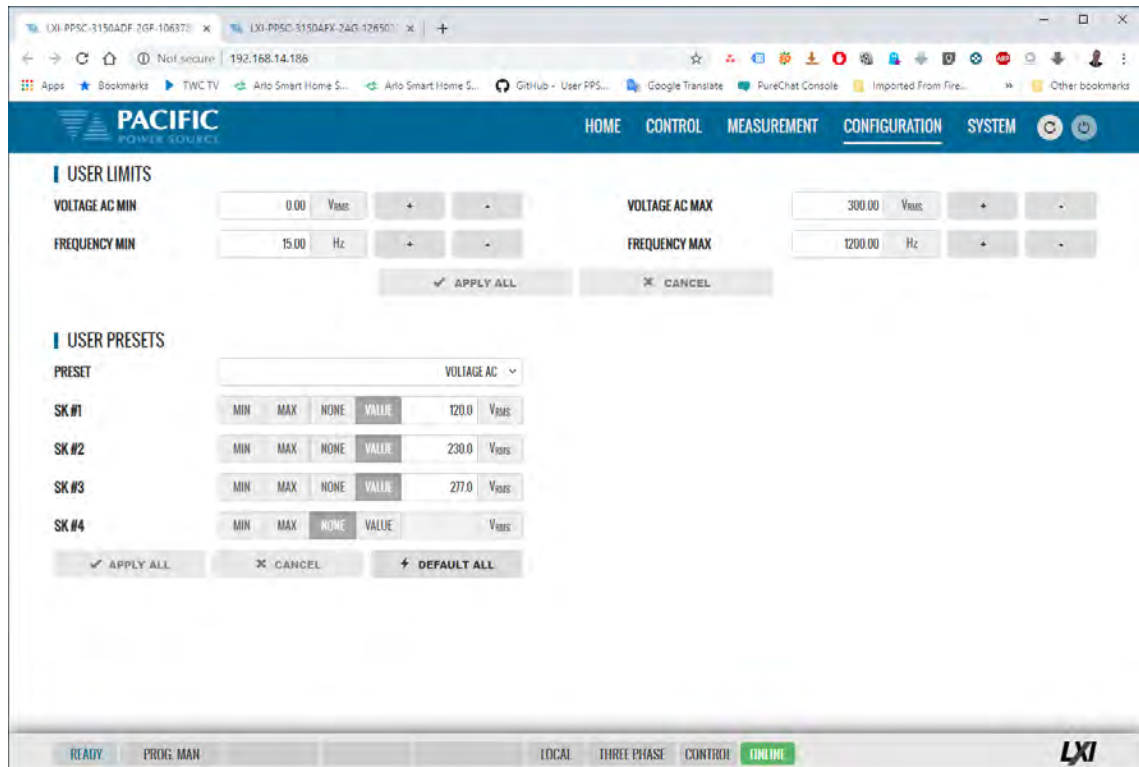

User programmable presets can be set to define the set values of the Soft keys in the program screens. This allows commonly used setting values to be selected by an operator by just pressing a single soft key. See image above for samples.

10.9.3 Ramp Time & Slew Rate

The Slew Rate screen has entries for all available programmable slew rate settings. This includes Voltage AC and Frequency. Note that both are mutually exclusive as they would conflict with each other. To use programmable slew rates, the RAMP TIME must be disabled.

Slew Rates can be set for Voltage AC and Frequency.

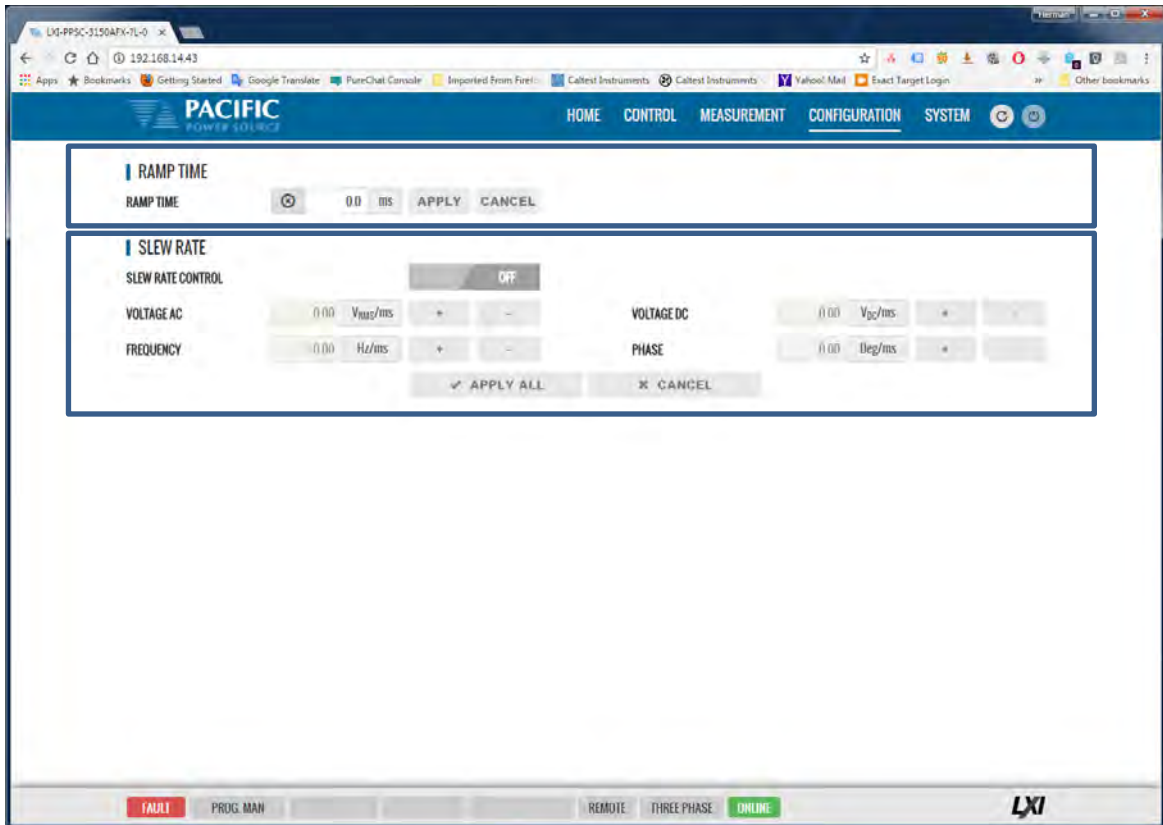

10.10 System Screens

The SYSTEM menu provides access to system level settings. System setting screens available are:

- ERROR/EVENT QUEUE
- FAULT LIST
- ERROR/EVENT LIST
- INTERFACE SETUP
- ACCESS CONTROL
- DIGITAL & ANALOG IOS
- UNIT INFORMATION
- PARALLEL UNITS
- MEMORY BROWSER
- CALIBRATION
- REMOTE SUPPORT
- IMPORT/EXPORT
- FIRMWARE UPDATE
- SANITIZE & REBOOT

Each is described in subsequent sections.

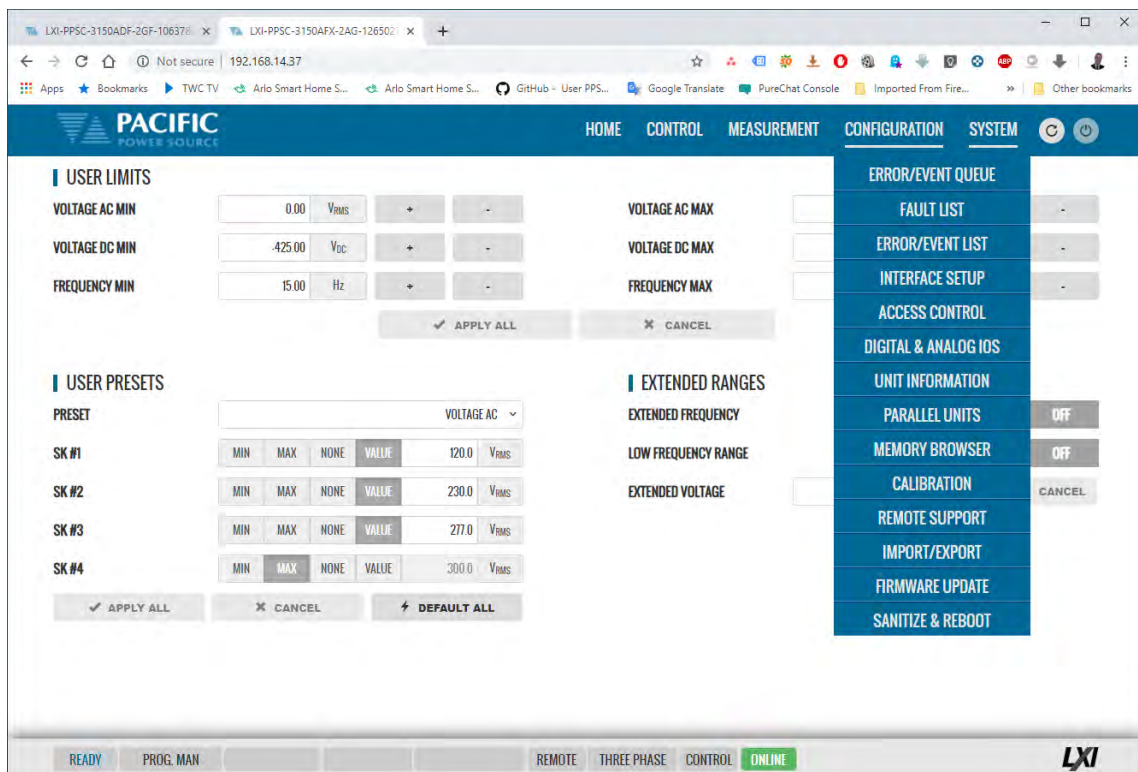

10.10.1 Error/Event Queue

The Error and Event Queue tracks internal errors or communication errors that may occur during normal user. Generally, such errors are the results of programming conflicts or setting conflicts and are no cause for concern. Other events may be normal, such as a power-on event and will be recorded in the same queue. The user can clear the queue at any time using the

CLEAR QUEUE button.

Actual hardware faults are tracked in the FAULT queue. See next section.

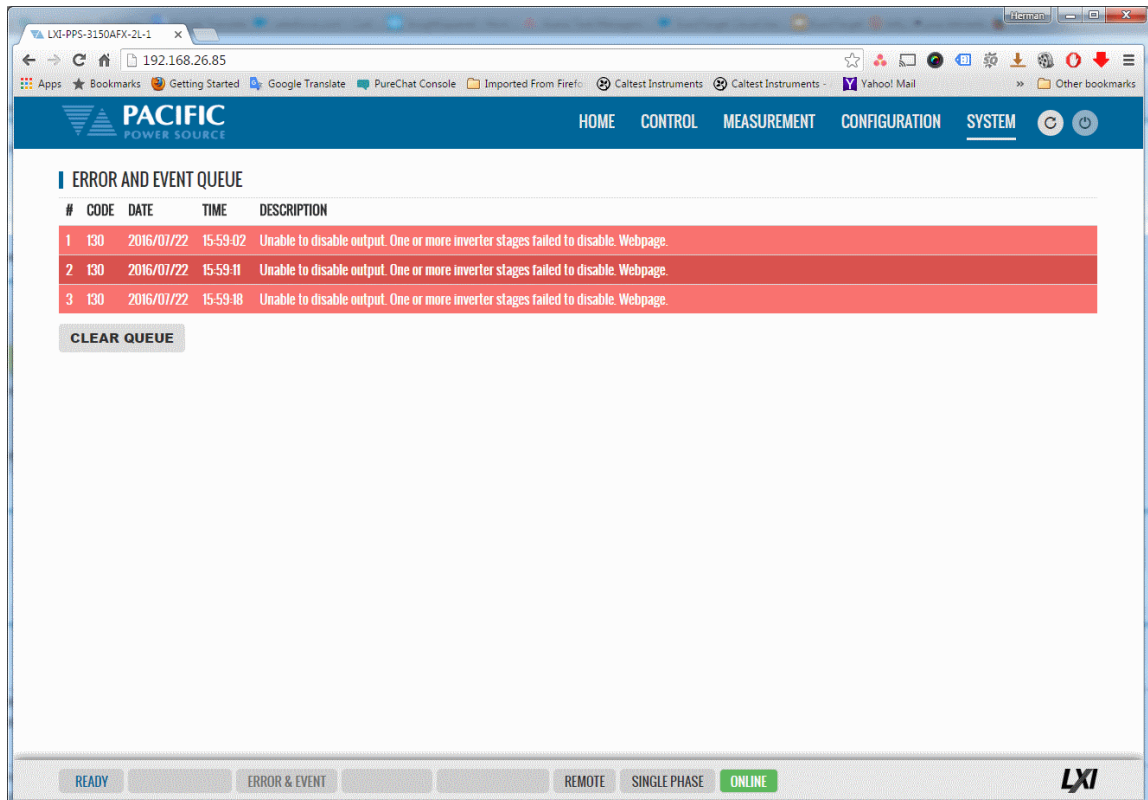

10.10.2 Fault List

The Fault List tracks hardware faults that may occur in the power conversion stages. This information may be useful for PPS engineering staff.

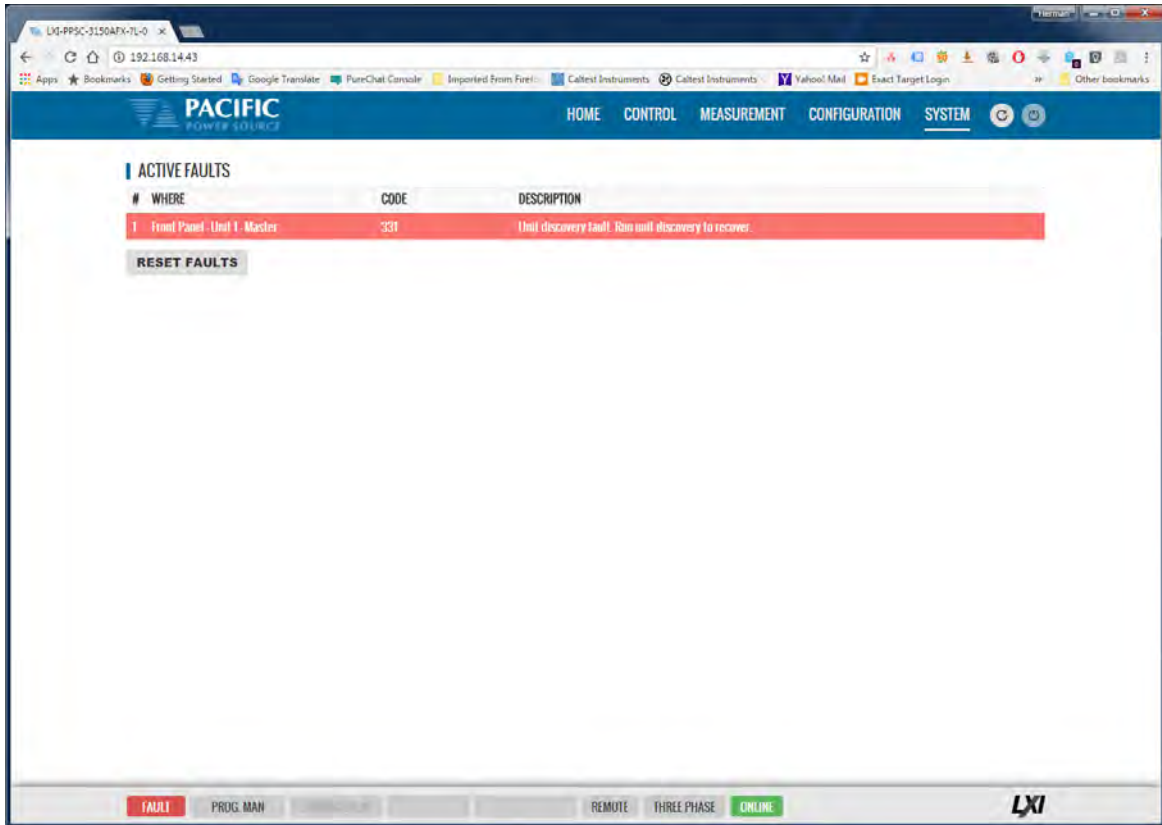

10.10.3 Error/Event List

The Error Event list provides a complete listing of all possible error and event messages. The description may include possible troubleshooting hints to resolve any error conditions.

Errors are listed in numerical order.

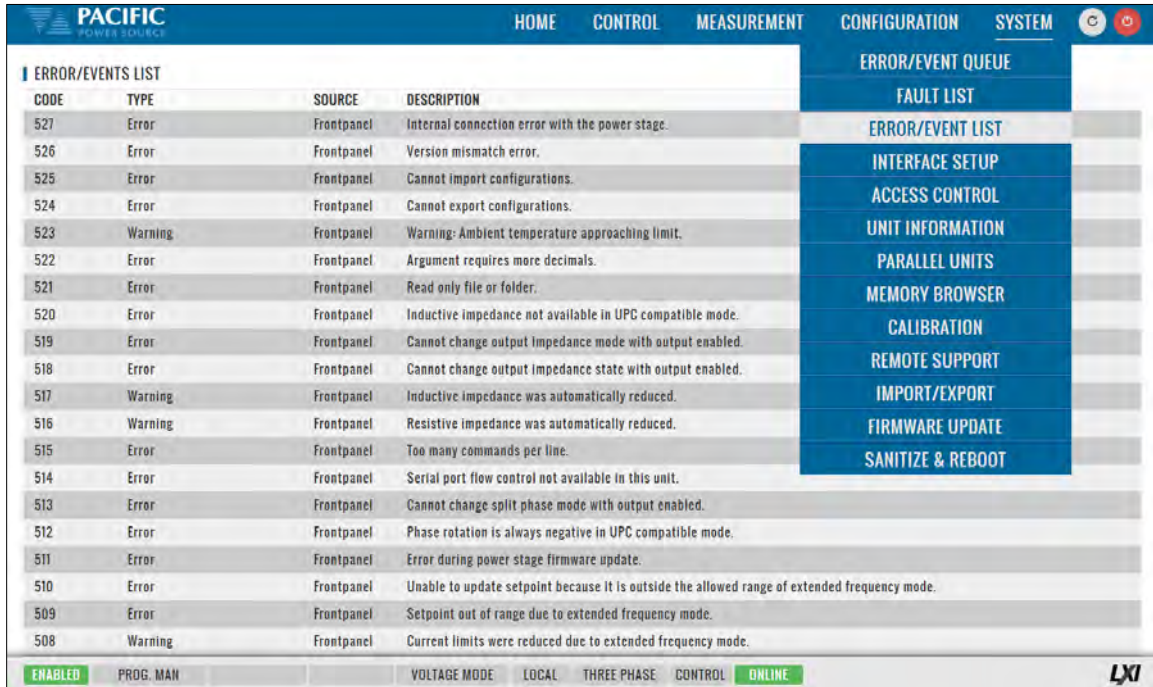

CODE	TYPE	SOURCE	DESCRIPTION
527	Error	Frontpanel	Internal connection error with the power stage.
526	Error	Frontpanel	Version mismatch error.
525	Error	Frontpanel	Cannot import configurations.
524	Error	Frontpanel	Cannot export configurations.
523	Warning	Frontpanel	Warning: Ambient temperature approaching limit.
522	Error	Frontpanel	Argument requires more decimals.
521	Error	Frontpanel	Read only file or folder.
520	Error	Frontpanel	Inductive impedance not available in UPC compatible mode.
519	Error	Frontpanel	Cannot change output impedance mode with output enabled.
518	Error	Frontpanel	Cannot change output impedance state with output enabled.
517	Warning	Frontpanel	Inductive impedance was automatically reduced.
516	Warning	Frontpanel	Resistive impedance was automatically reduced.
515	Error	Frontpanel	Too many commands per line.
514	Error	Frontpanel	Serial port flow control not available in this unit.
513	Error	Frontpanel	Cannot change split phase mode with output enabled.
512	Error	Frontpanel	Phase rotation is always negative in UPC compatible mode.
511	Error	Frontpanel	Error during power stage firmware update.
510	Error	Frontpanel	Unable to update setpoint because it is outside the allowed range of extended frequency mode.
509	Error	Frontpanel	Setpoint out of range due to extended frequency mode.
508	Warning	Frontpanel	Current limits were reduced due to extended frequency mode.

10.10.4 Interface Setup

The Interface setup screen allows enabling or disabling of several available interfaces and operating modes. The interfaces are arranged by type:

- LAN
- USB
- RS232 Serial
- GPIB (Option) **(Note: on A version ADF Models only)**

Interfaces that are not used can be turned off to avoid conflicts caused by multiple active interfaces at the user's discretion.

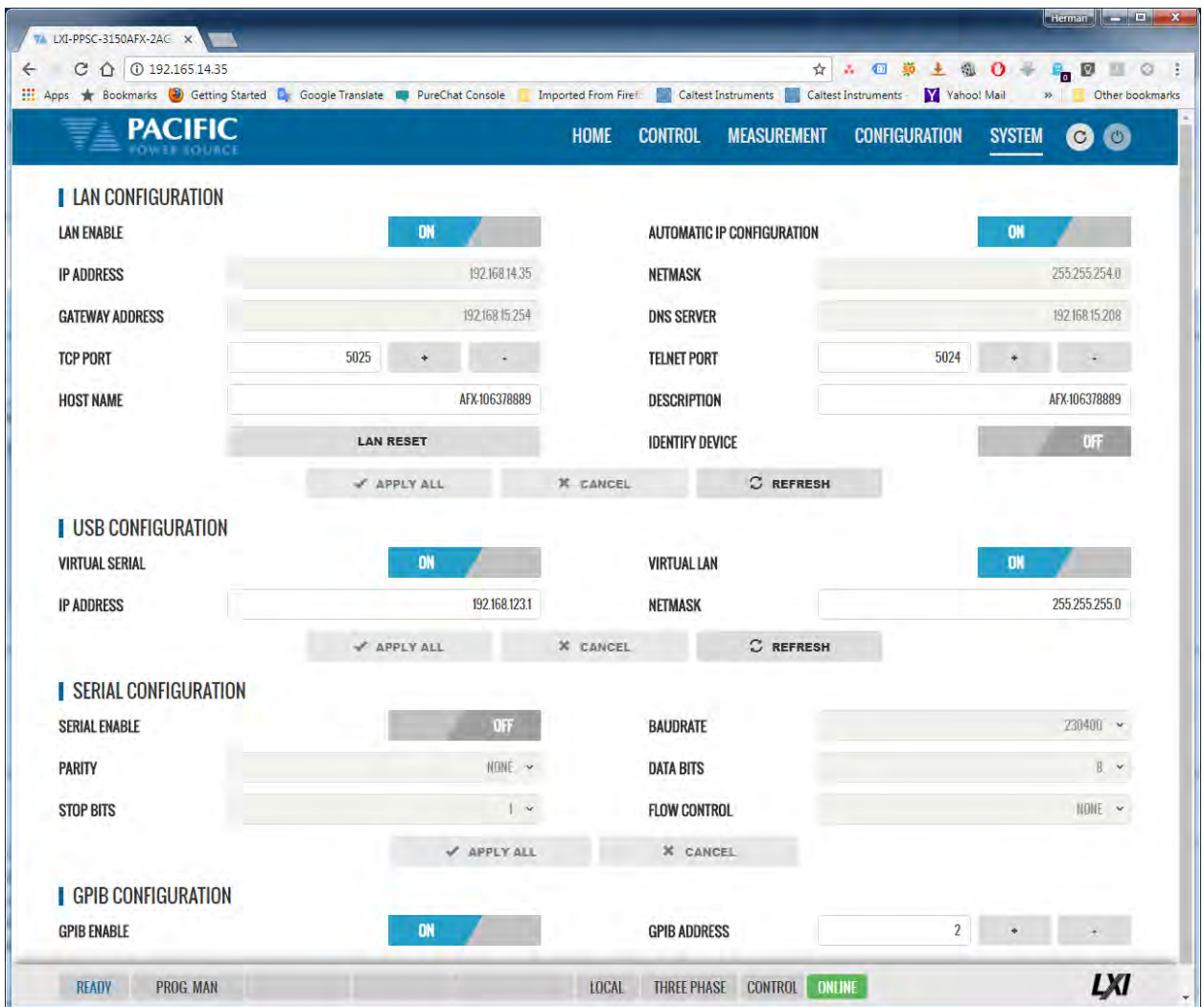

10.10.5 Access Control

The access control screen allows restricting access to the power source over the LAN interface. This is an important requirement for power sources connected to a company wide Ethernet network. Without access restrictions, persons not present where the power source is located could inadvertently cause a dangerous condition by either enabling the OUTPUT or changing programmed settings.

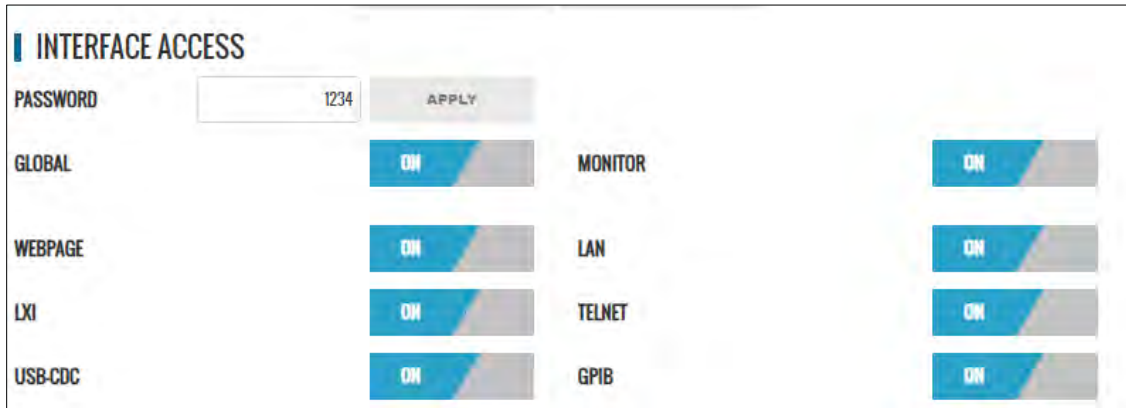

Access control can limit access from specific IP addresses only and requires someone physically present where the power source is to grant access to anyone else.



For more details, refer to section 10.3, “Access Control” on page 304 of this manual.



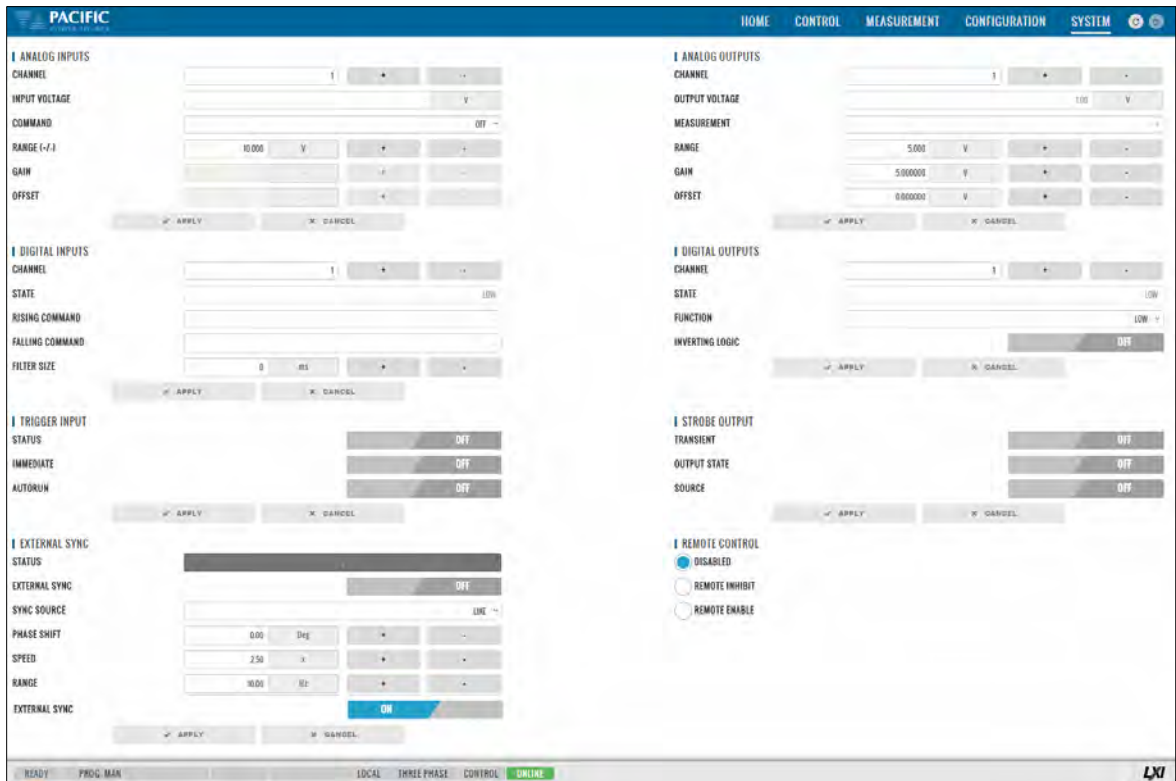

10.10.6 Digital & Analog IO's

The Digital and Analog IO screen allows configuration of the available Auxiliary I/O functions. Note that this feature is not available on ADF-2L and ADF-4L models.

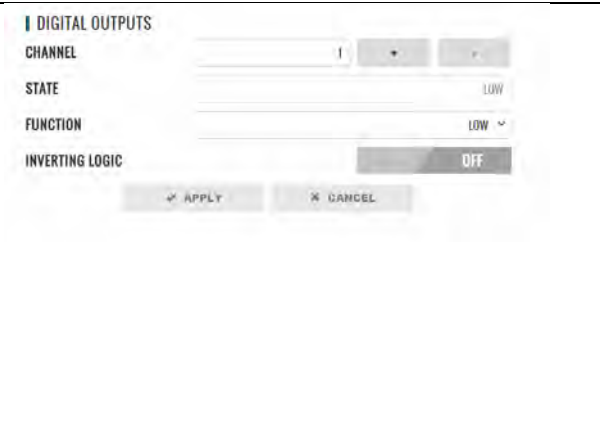

There are eight groups of functions that are available to be configured with the selectable settings listed in the table below.

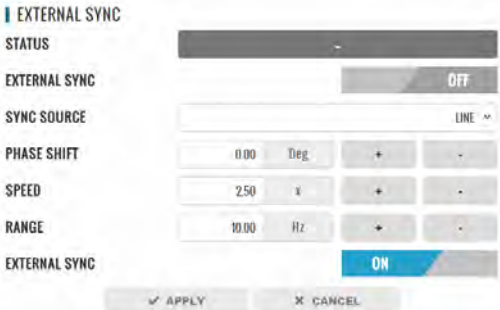
Grouping	Controls
<p>Analog Inputs:</p> <p>CHANNEL [1 2 3 4]</p> <p>INPUT VOLTAGE Displays read back voltage</p> <p>COMMAND Select command from dropdown list or OFF for none</p> <p>RANGE 0.0000 – 10.000 V</p> <p>GAIN Gain</p> <p>OFFSET Offset value</p>	
<p>Analog Outputs:</p> <p>CHANNEL [1 2 3 4]</p> <p>OUTPUT VOLTAGE Output setting</p> <p>MEASUREMENT Select measurement to be assigned to output</p> <p>RANGE 0.0000 – 5.000 V</p> <p>GAIN Gain 0.000 - 1000</p> <p>OFFSET Offset value – 1000 ~+1000</p>	
<p>Digital Inputs:</p> <p>CHANNEL [1 2 3]</p> <p>STATE Displays input state</p> <p>RISING CMD Set command string to execute on rising edge</p> <p>FALLING CMD Set command string to execute on falling edge</p> <p>FILTER SIZE 0 – 10,000,000 msec</p>	
<p>Digital Outputs:</p> <p>CHANNEL [1 2 3 4]</p> <p>STATE Displays current state</p> <p>FUNCTION Assigns state to selected channel. Available states are: FAULT FORM HIGH LOW OUTPUT STATE PROGRAM REMOTE TRANSIENT</p> <p>INV. LOGIC [ON OFF] Reverses polarity</p>	

Grouping	Controls
<p>Trigger Input:</p> <p>STATUS [ON OFF] Enabled or disabled</p> <p>IMMEDIATE [ON OFF] Ignore phase update setting if ON</p> <p>AUTORUN [ON OFF] No RUN command required if ON</p>	
<p>—Strobe Output:</p> <p>TRANSIENT ON = Strobe output on transient start</p> <p>OUTPUT STATE ON = Strobe output on relay close</p> <p>SOURCE ON = Strobe output on any program parameter change</p>	
<p>External Sync:</p> <p>STATUS Display SYNC Status</p> <p>EXTERNAL SYNC [ON OFF]</p> <p>SYNC SOURCE Select Sync source</p> <p>Available sources are: - External sync input on I/O connector - LINE (AC input to power source)</p> <p>PHASE SHIFT Offset Phase A angle</p> <p>SPEED 1.00 ~ 10.00</p> <p>RANGE 0.10 ~ 500 Hz</p> <p>EXTERNAL SYNC [ON OFF]</p>	
<p>Remote Controls:</p> <p>DISABLED No remote output control</p> <p>REMOTE INHIBIT Contact closure needed to close output relay</p> <p>REMOTE ENABLE Contact closure or front panel can control output relay</p> <p>See section 5.18.3</p>	

10.10.7 Remote Interface (Virtual Front Panel)



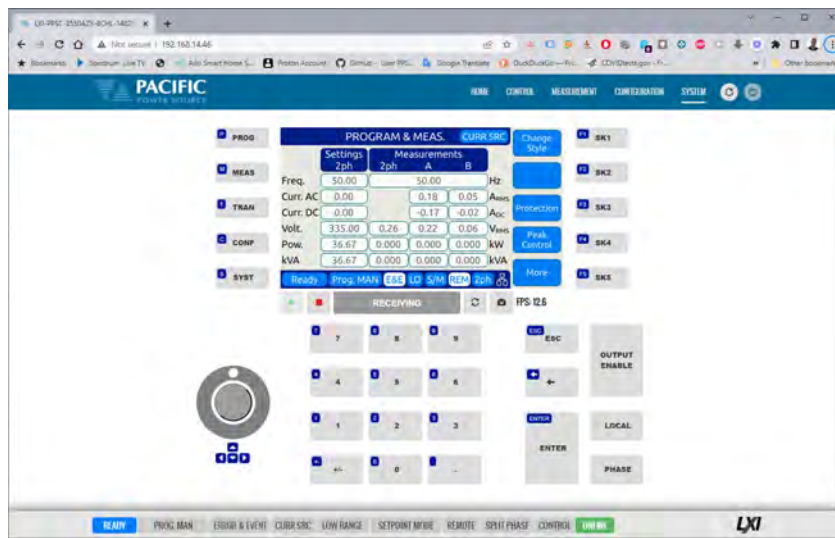

The Remote Interface browser screen provides a virtual front panel that allows controlling the power source from a remote location using a PC, tablet or smart phone. The screen layout is a function of the web hosting device screen width. If wide enough, the layout will match that of the actual front panel of the power source. If too narrow for a landscape view, the front panel will be divided between the LCD screen, function and soft keys on top and the know plug decimal keypad and other control beneath it. Both layouts are shown below.



The operation of this Virtual Front panel is identical of that of the physical front panel so refer to Section 6, “Front Panel Operation” on page 82 for user information. The operation of this Virtual Front panel is identical of that of the physical front panel so refer to Section 6, “Front Panel Operation” on page 82 for user information. The controls located directly below the virtual LCD screen may be used when the internet connection used is slow or there is too much latency.



Available controls are:

-  Enable continuous update mode. In this mode, the status bar will show .
-  Stop continuous updated mode. The connection status will show .

RECEIVING Status Bar shows state of connection to the power source. Clicking on it will toggle connections status between **DISCONNECTED** and **CONNECTED**.

 Refresh button may be used when continuous updates are off to refresh the display

 Click to download a .png image of the virtual LCD display.

The status field to the right of the control buttons display the measurement frame update rate. In the example shown here the frame rate is 14.6 frames per second.

10.10.8 Unit Information

The Unit Information screen contains some of the same information as is found on the HOME screen but it can be used to query this information from one or more auxiliary unit as well in a parallel system. The HOME screen will only display information for the Master unit of a parallel configured system. Use the SELECTED UNIT control to select units downstream from the master (1).

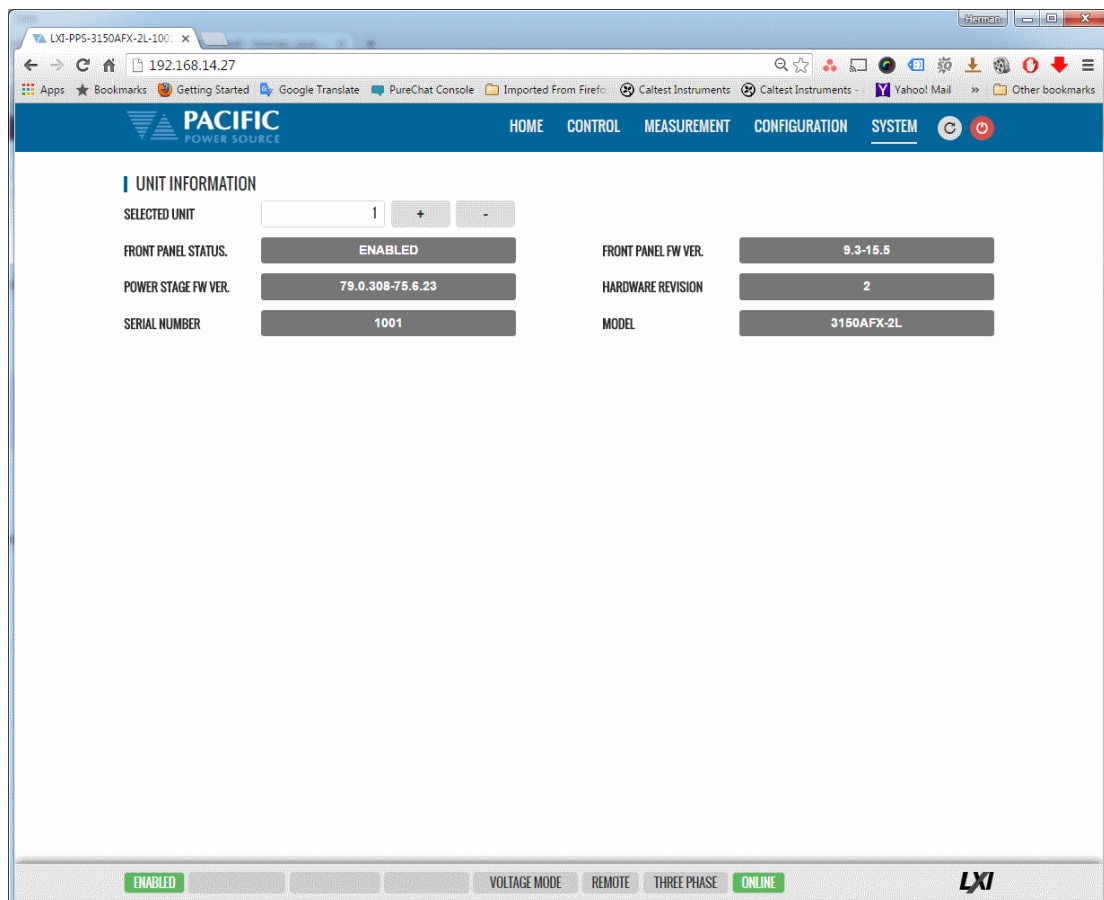

10.10.9 Connected Units

The Connected Units screen displays the number of powered on units connected in either a Parallel or Series system. It also allows the expected number of units to be set so the master can determine if all connected units are indeed turned on before starting operation.

The MANUAL DISCOVERY can be run to refresh the system configuration if a unit has been turned on or off without power cycling the master.

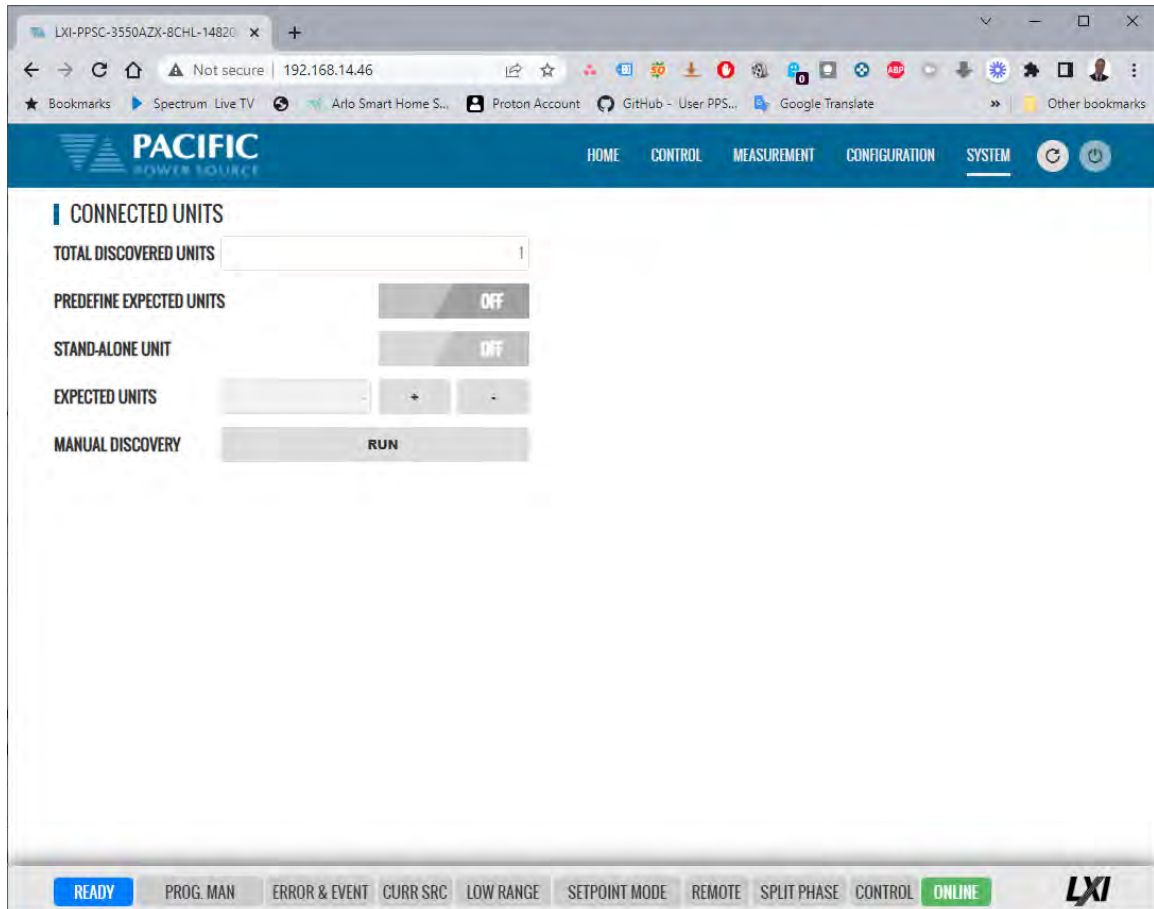

10.10.10 Memory Browser

The Memory Browser screen shows available memory devices connected to the instrument including internal memory and available directories and files. All data and setup files are in XML format. Waveform files are stored in CSV format. Screen captures are stored in PNG image format.

Available MEMORY DRIVES are INTERNAL, RAM and any USB or SD-Card memory devices that are mounted.

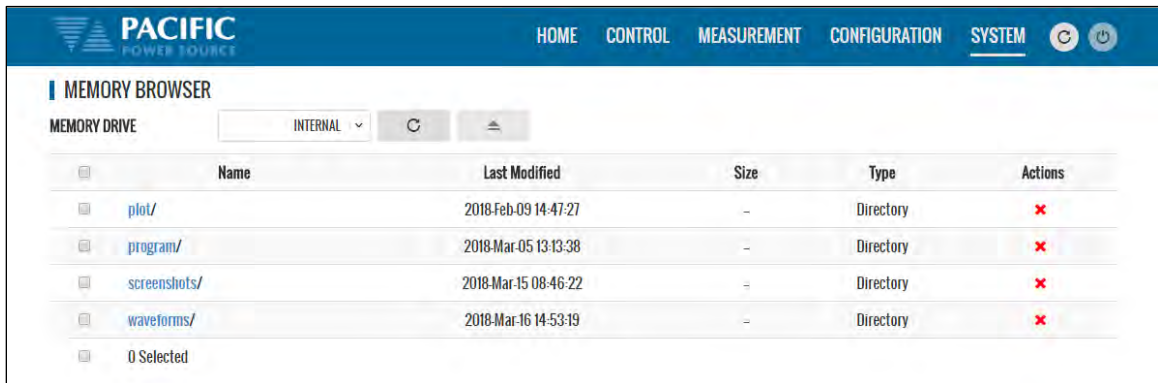

Useful directories for the user are:

DIRECTOR	FILES IN THIS DIRECTORY
plot/	Data logger plots in csv file format with date and time stamp
program/	Power source program settings
screenshots/	Screen capture image files in .png format with date and time stamp. To capture any LCD display, press the LOCAL key and the number 1 key on the decimal keypad at the same time.
waveforms/	User waveform data points in csv file format.

10.10.11 Calibration

The Calibration screen shows all user accessible calibration coefficients. It also allows for user calibration of voltage and current to be performed. The Web Browser user interface is specific but the procedures and equipment are the same as calibration from the front panel. Refer to Section 11.4, “Calibration Procedures” for details.

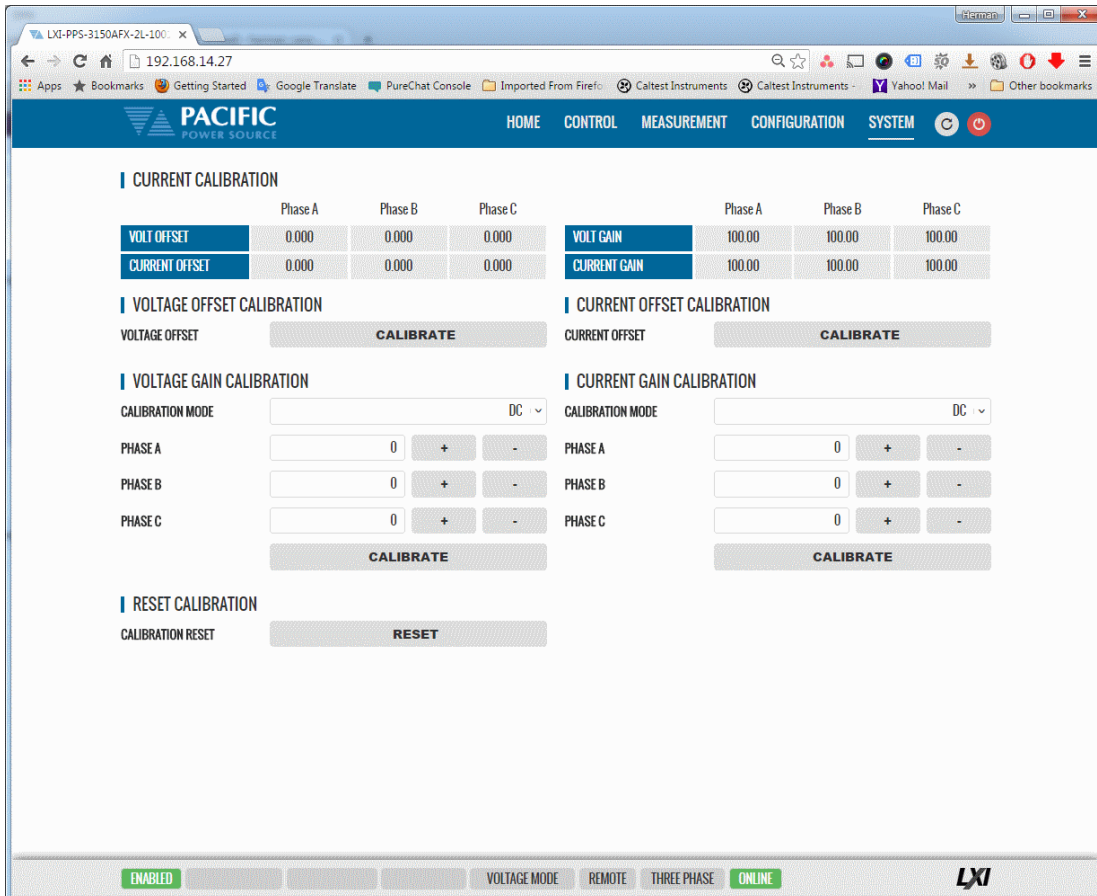

10.10.12 Remote Support

The Remote Control screen allows Pacific Power’s technical support staff to access the unit remotely if granted permission. Internet access is required for this feature.

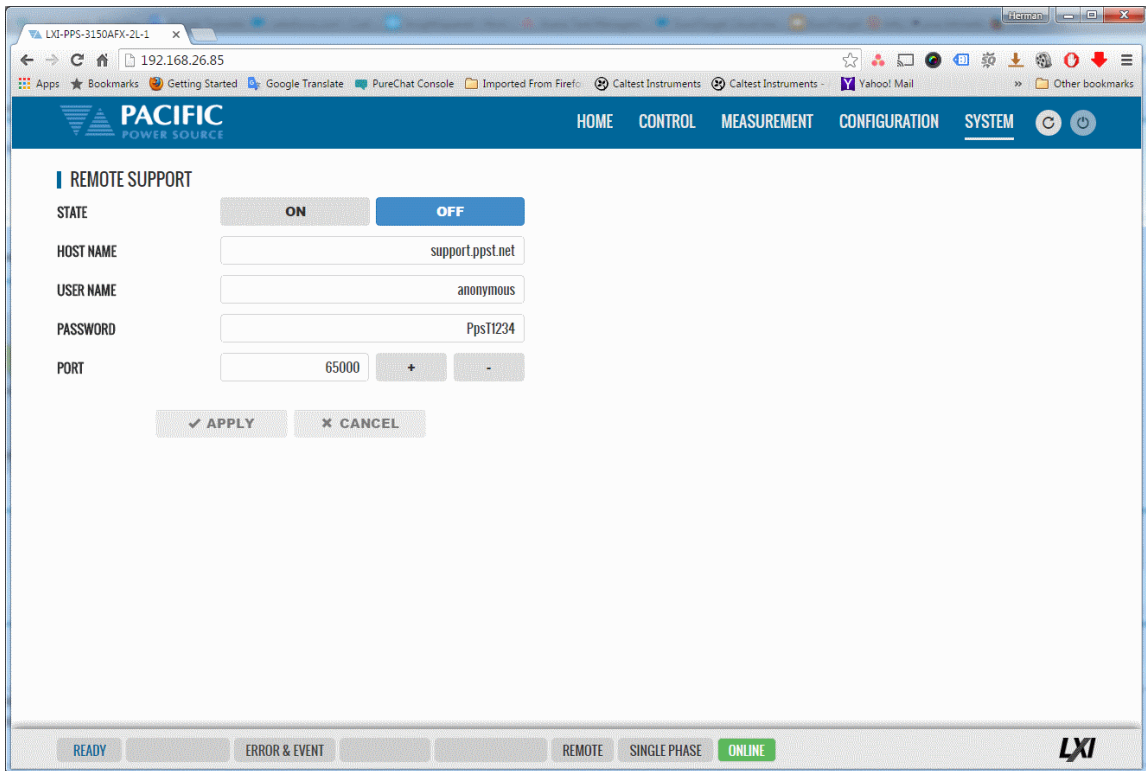

10.10.13 Import / Export



A compressed file containing complete system configuration data for the power source can be exported to a file and imported back into the unit as needed. Files are .7z compressed to maximize storage space. Use the Export button on the right to export (save) current configuration data. Use the Browse button to select and import (load) a previously saved configuration file.



10.10.14 Firmware Update

The Firmware update screen can be used to install new firmware for a file. New firmware may be distributed by email or from Pacific’s FTP site. Note that the OUTPUT of the unit must be OFF to perform a firmware update.

If you received a firmware image file (.img extension):

- Use the  button to select it from the drive location you saved it to.
- Then use the  button to upload new firmware to the power source.

To install new firmware from the Pacific Power FTP server:

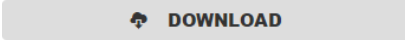
- Click the  button.

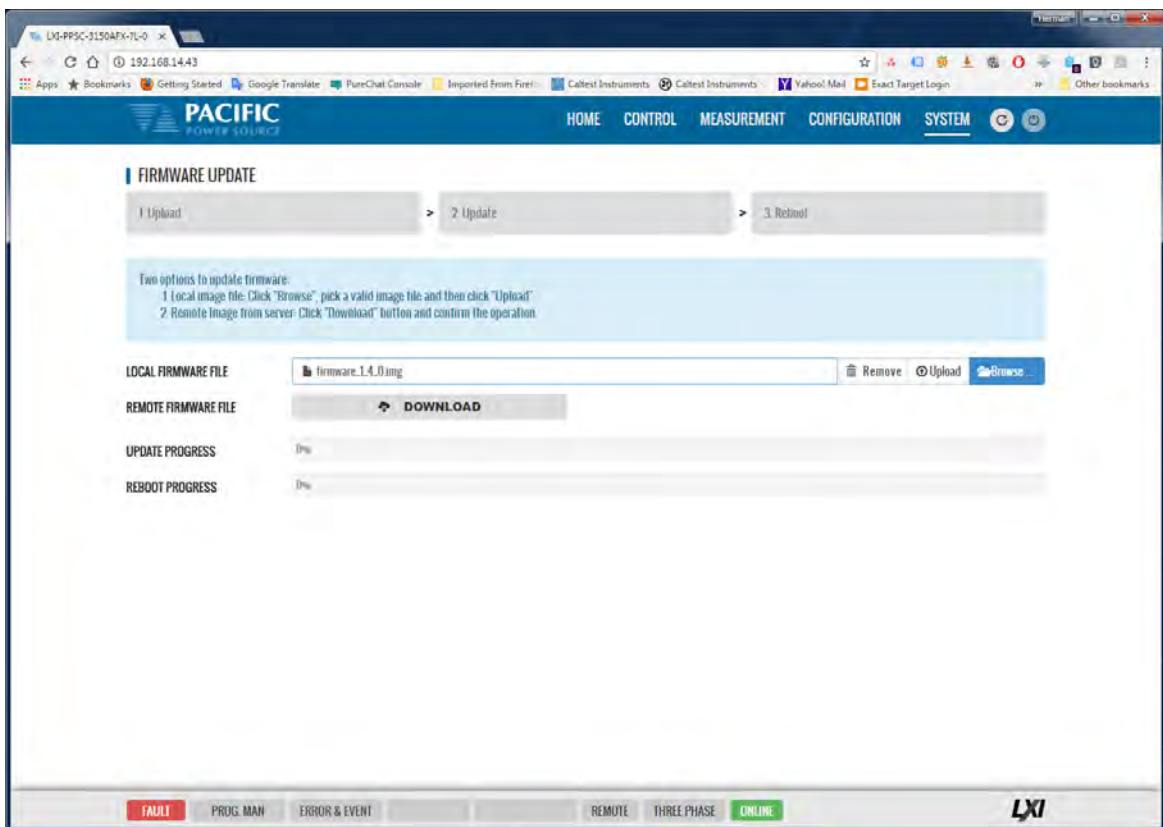

10.10.15 Sanitize and Reboot

This screen allows the unit to be cleared of all user settings. This applies to waveforms, settings, transients etc. The unit will be reset to factory default conditions.

The Reboot allows the power source to be rebooted (reset) without cycling AC input power.

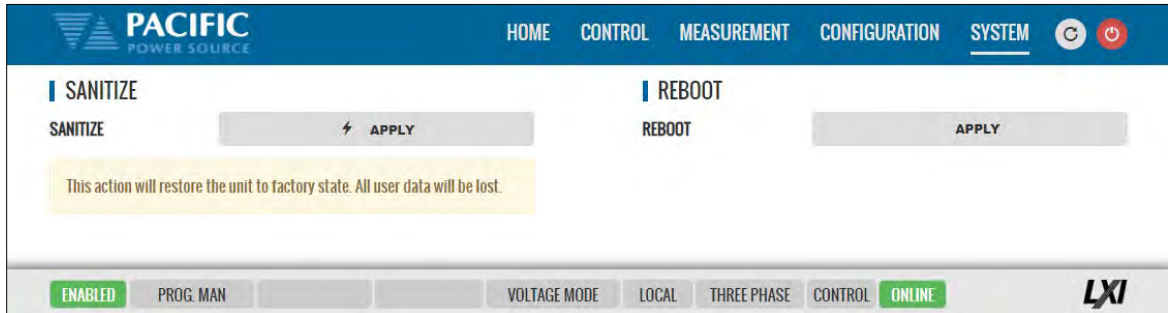

10.11 Additional Functions

Additional function may be added over time through firmware updates that may not be covered by this user manual revision. If so, check the Pacific Power website for update manual versions. (www.pacificpower.com).

10.11.1 Sharing Options – FTP & SAMBA

Units with firmware revision 2.1.0 or higher support a network based sharing feature. Two protocols. These can be enabled from the Sharing Options screen. For more details, refer to 6.8.5.9, “REMOTE SHARING” on page 135.



11 Calibration

11.1 Calibration Interval

All units are shipped new from the factory with NIST traceable calibration. It is recommended to perform an annual calibration check to ensure performance to specifications. Under normal circumstances, no adjustment will be needed but can be made as part of the user calibration coefficients.

11.2 Closed Case User Calibration

This section covers routine calibration that can be performed by the user. User calibration does not affect the factory set calibration coefficients that were determined and set at the time of shipment to ensure compliance with published specifications. Rather, user calibration can be used to obtain enhanced performance at typical operating conditions by adjusting these user coefficients at these conditions. For example, if the unit is used primary for testing 400Hz, three phase 115V L-N three phase operation, calibrating the user coefficients to these operating conditions against an external precision reference can provide enhanced performance versus published specifications (See Section 4, “Technical Specifications”).

Since user calibration does not affect factory calibration settings, resetting all user calibration coefficients does not invalidate the units specified performance and it can be used with all user coefficients reset as needed.

Note: There are no analog adjustment pots in this instrument and all calibration can be performed from the front panel or over one of the digital control interfaces.

11.3 Equipment Required

The following list of equipment or equivalent is required to perform routine annual calibration of the instrument. Current sensor options are determined by need for AC, DC or both.

Item	Make	Model	Notes
1	Keysight	34465A	6 ½ Digit DMM or equivalent
2	Current Transformer (AC Only)	Pearson	Model 110, 65 Arms Max. 5000Apk Max. 0.1V/A +1/-0%, Rout = 50 Ohms http://www.pearsonelectronics.com/products/current-monitors
3	Current Sensor (AC and DC)	LEM	IT 200-S ULTRASTAB, 200 A, ± 0.0086% Accuracy, 50 kHz BW or equivalent. https://www.lem.com/en/product-list/it-200s-ultrastab Requires precision burden resistor for direct DMM measurements, i.e. Reidon, P/N SM10-100RX, 0.01% 100 Ohm, 0.3W, qty 2 or 3 in parallel for 50 Ohm or 33.3 Ohm burden https://www.digikey.com/product-detail/en/riedon/SM10-100RX/696-1568-ND/4832952
4	Current Shunt (DC)	Ohm-Labs	CS-200, Shunt, 1 mOhm, 0.02% Accuracy @ DC to 50/60 Hz or equivalent http://www.ohm-labs.com

Table 11-1: Required Calibration Equipment

11.4 Calibration Procedures

Calibration of output and measurements is performed by a single procedure so there is no need to calibrate each separately. Calibration involves voltage and current full scale and offset on each phase. For three-phase mode, this means there are twelve calibration points, for single-phase mode, there are four.

The calibration can be performed manually using the Calibration menu (refer to Section 6.8.9 for the location of the Calibration menu) or through the build-in web server using the web browser interface. Refer to Section 10.10.10, “Calibration” for access to the Web based calibration screens.

11.4.1 Voltage Calibration - Offset

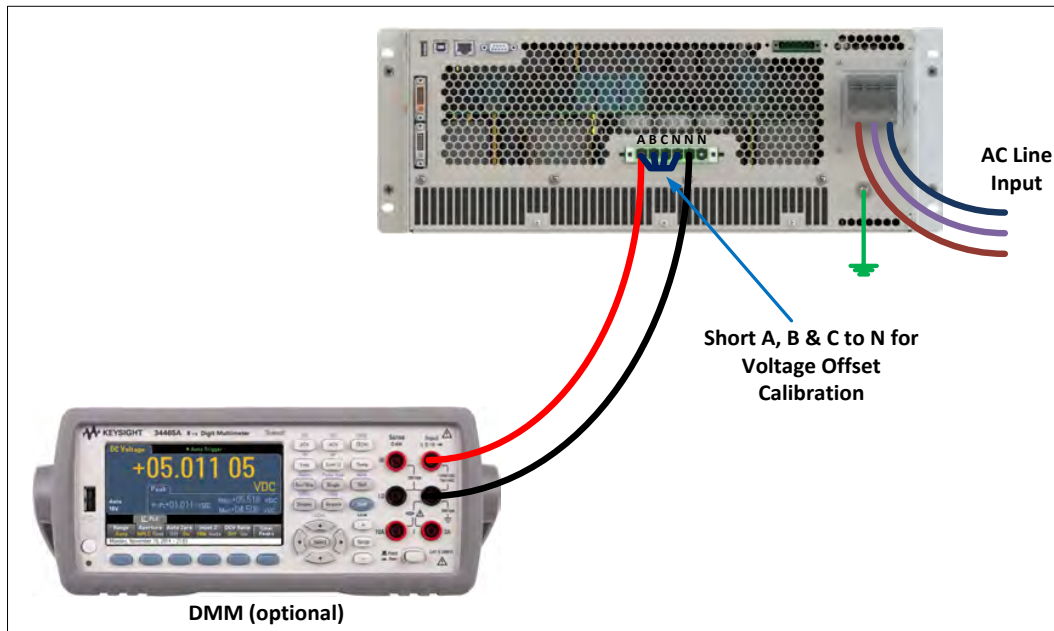
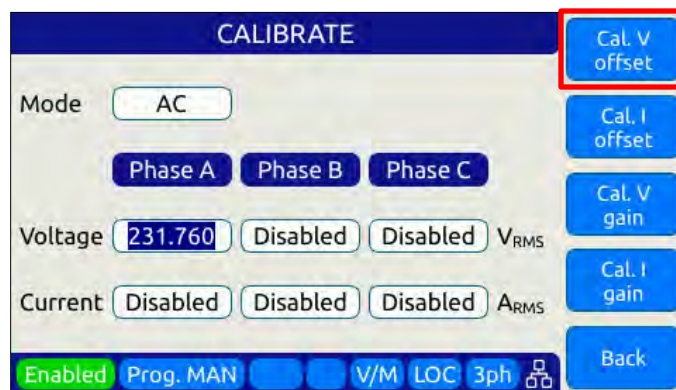

Table 11-2: Setup for Voltage Offset Calibration

The procedure to calibrate voltage offset is:



1. Select the Calibration entry from the “System” menu
2. Press the “Calibrate” soft key to enter calibration mode

3. Short all phases to neutral using a shorting jumper
4. You can connect the DMM to the output of phase A as shown in the figure above but it is not required for this calibration step.
5. **IMPORTANT:** Program AC voltage to all **zero volts** to avoid any current from flowing into the shorted outputs. Use PROGRAM screen to make sure AC settings are zero.
6. Enable the Output with the output shored.
7. Press "Cal V. offset" soft key
8. Wait for the V offset coefficients for all phases to be calculated and displayed
9. Remove the shorting jumper when done

Note: The Mode, Voltage and Current edit boxes do not affect this function.

11.4.2 Current Calibration - Offset

The procedure to calibrate current offset is:

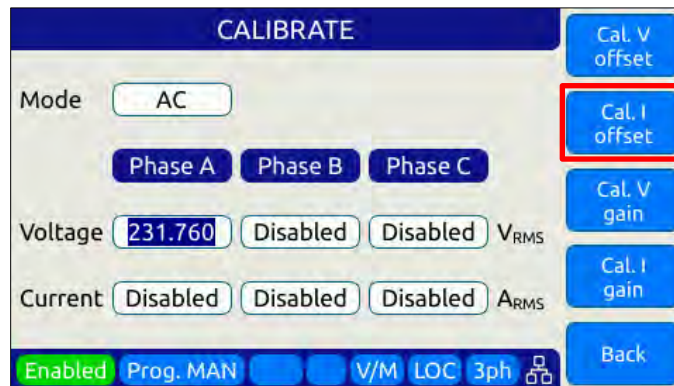

1. Select the Calibration entry from the “**System**” menu
2. Press the “Calibrate” soft key to enter calibration mode
3. Do not connect any load to the output
4. Enable the Output with no load connected
5. Press "Cal I. offset" soft key
6. Wait for the I offset coefficients for all phases to be calculated and displayed

Note: The Mode, Voltage and Current edit boxes do not affect this function.

11.4.3 Voltage Calibration - Gain

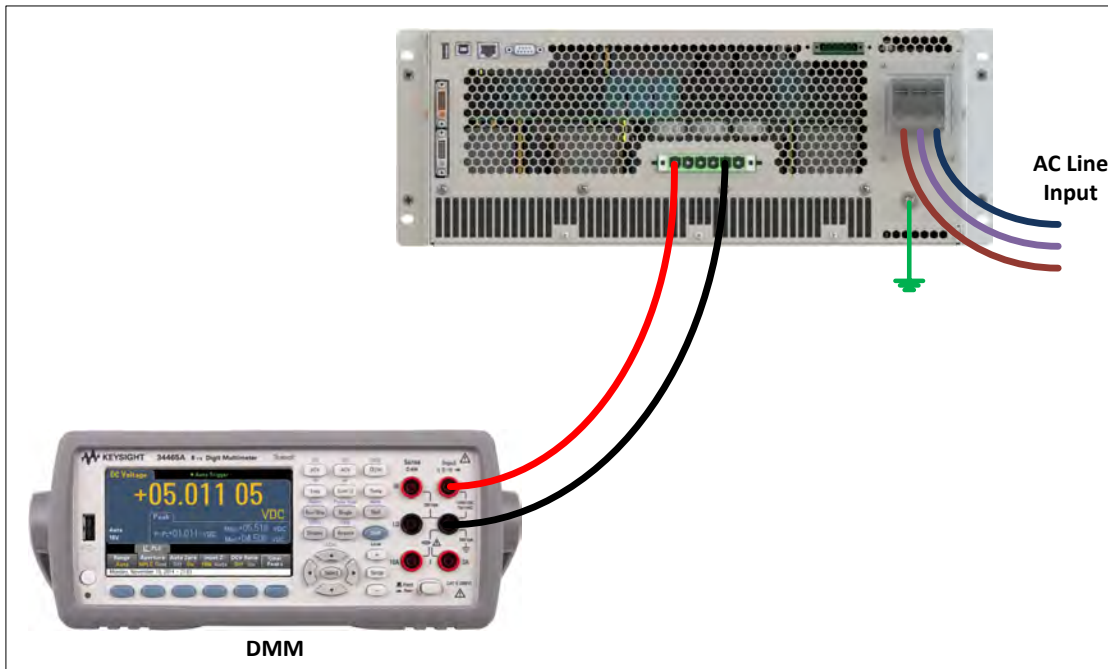
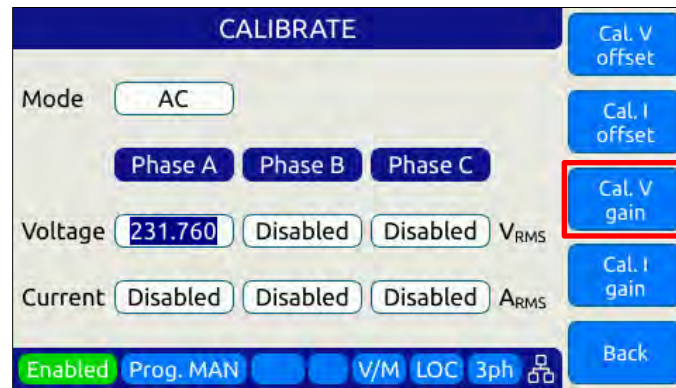

Figure 11-1: Voltage Calibration Equipment Setup – 1 or 3 Phase Mode – Phase A

The procedure to calibrate voltage gain is:



1. Select the Calibration entry from the “System” menu
2. Press the “Calibrate” soft key to enter calibration mode
3. Do not connect any load to the output
4. Program AC voltage to full scale 300.0 Vrms L-N for AC mode calibration on all phases. Use the PROGRAM screen for this.
5. For AC mode calibration, set the Frequency to the most commonly used value depending on typical applications
6. NOTE: If the user calibration is targeted for specific operating conditions, for example Vac = 115V L-N and Freq = 400 Hz, use these settings instead of those suggested in steps 4 and 5

7. Enable the Output with no load connected
8. Enter the DMM VAC readings for all three phase in the respective Voltage data entry text boxes in the Calibration screen. Move the DMM probe from phase A, to B to C respectively to obtain each phase reading.
9. Press "Cal V. gain" soft key
10. Wait for the V gain coefficients for all phases to be calculated and displayed

11.4.4 Current Gain Calibration Setup Diagrams

For current calibration, a resistive load equivalent to 90% of maximum available RMS phase current for the phase mode selected is recommended. It is permissible to use only one load and move it between phases for three-phase mode calibration. For single-phase mode current calibration, a load capable of supporting 90% of maximum available single-phase current is recommended. The A, B and C outputs must be shorted together for single-phase mode operation. The optional Single Phase Shorting Connector (P/N 160086) can be used to accomplish this.

Note: To guarantee that the current doesn't change during the calibration process, it is recommended that the unit is operated at current limit, but reducing its set point to the desired value. It is also recommended to use a stable load that provides a constant linear impedance to the unit.

A suitable current shunt must be connected in series with the load as shown below for three-phase mode. The sense terminals of the current shunt must be connected to the DMM Voltage input.

Three Phase Mode Setup

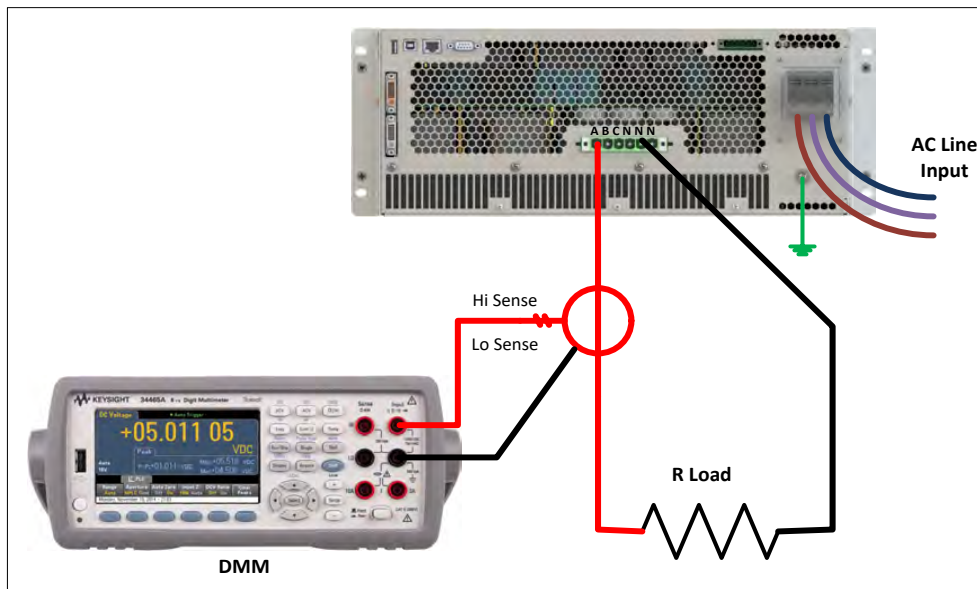

Figure 11-2: Current Calibration Equipment Setup – 3 Phase Mode – Phase A

Single Phase Mode Setup

For Single-phase mode current Calibration, the load must have the appropriate size. See next section for recommended load value by model and phase mode.

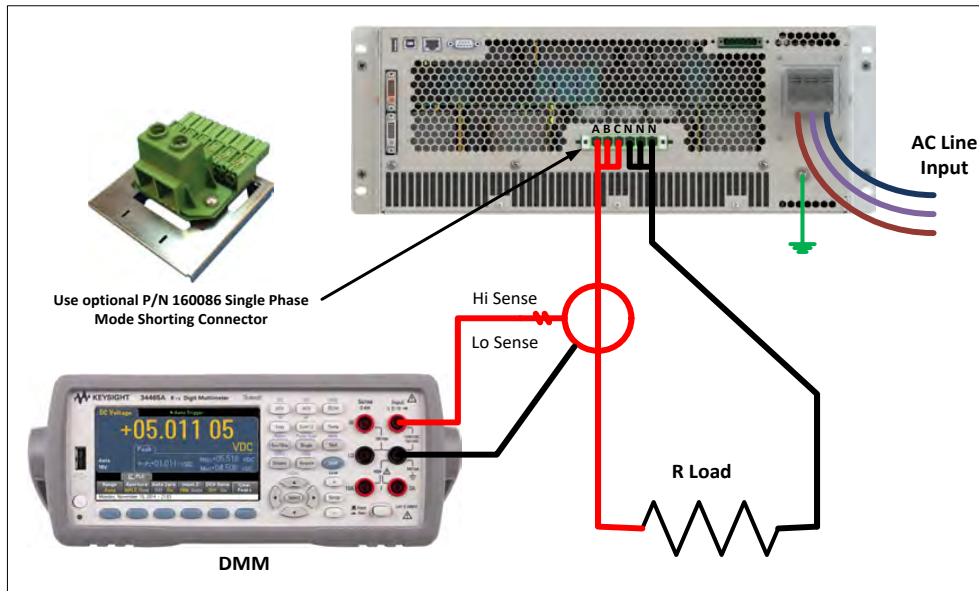

Figure 11-3: Current Calibration Equipment Setup – 1 Phase Mode

11.4.1 Current Calibration Load Values

Full-scale current gain calibration is best performed at current levels that are around 90% of full scale current. Since the ADF Series® has only a single voltage range, maximum RMS current is available at 120Vrms L-N for each phase. For single-phase mode, the current is three times higher. Thus, to obtain 90% of load current, resistor value that is sized to draw this current level at around 120Vrms is required. Since the maximum current varies by model and phase mode, the table below shows the recommended resistor values or resistive load bank settings.

Model	Rating/phs VA/W	Three & Two Phase Mode Calibration			Single Phase Mode Calibration		
		Max. I _{rms} /phs	Current (90%)	Recommended R Load (Ohm)	Max/ I _{rms}	Current (90%)	Recommended R Load (Ohm)
190ADF	9000				75.0	67.5	1.07
390ADF	3000	25.0	23	5.33			
1150ADF	15000				125.0	113	1.07
3150ADF	5000	41.7	38	3.20			
3300ADF	10000	83.3	75	1.60			
3450ADF	15000	125.0	113	1.07			
3600ADF	20000	166.7	150	0.80			

Table 11-3: Calibration Load Values by Model and Phase Mode

11.4.2 Current Calibration - Gain

The procedure to calibrate current gain is:

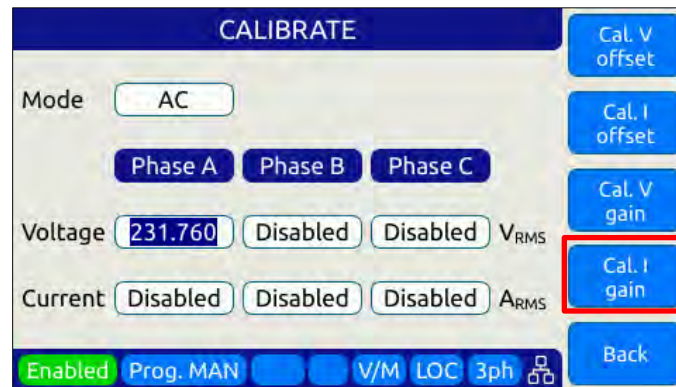

1. Select the Calibration entry from the “**System**” menu
2. Press the “Calibrate” soft key to enter calibration mode
3. Connect the required resistive load value to the output of phase A or all three outputs if three loads are available.
4. Program AC voltage to 120.0 Vrms L-N on all phases
5. Set the Frequency to the most commonly used value depending on typical applications
6. Enable the Output
7. Allow the load current to stabilize by monitoring the DMM current reading for each phase.
8. Enter the DMM VAC readings for all three phase in the respective Current data entry text boxes in the Calibration screen. If only one shunt and load is available, repeat the above steps for phase B and C making sure to turn OFF the output before moving the load and shunt to the next phase.
9. Press "Cal I. gain" soft key
10. Wait for the I gain coefficients for all phases to be calculated and displayed

11.4.3 Exit Calibration Mode

To exit the calibration mode once done, press the “**Back**” software.

12 Warnings & Error Messages

12.1 Preface

During normal operation, a series of error and/ or warning messages may be displayed on the front panel LCD display or reported by the error queue over one of the remote control interfaces. This section of the manual lists available warning and error messages in numerical order and provided some additional information on their meaning and possible causes. Where relevant, suggested remedies to resolve any conditions are included as well.

Note: There are some Error and Warning messages that may appear in the Errors & Events that are **NOT** listed in the next section. In case you encounter an unlisted error or warning message and code, contact Pacific Power customer service (support@pacificpower.com) and describe the number and description to obtain further information.

After reporting such an event, try rebooting the power sources by cycling power as most of these conditions will clear up with a reboot.

12.2 Errors & Warnings Messages in Numeric Order

Source	Code	Type	Description	Possible cause
Frontpanel	-500	"SCPI standard event"	"Event: Power ON."	Power on event detected. Normal after power on
Frontpanel	-350	"SCPI standard event"	"E&E queue overflow."	
Frontpanel	-360	"SCPI standard error"	"Communication error with an interface."	
Frontpanel	-320	"SCPI standard error"	"Storage fault."	
Frontpanel	-310	"SCPI standard error"	"System error"	
Frontpanel	-290	"SCPI standard error"	"Execution error: Memory use error."	
Frontpanel	-286	"SCPI standard error"	"Execution error: Not allowed command with the current configuration."	
Frontpanel	-285	"SCPI standard error"	"Execution error: Program syntax error."	
Frontpanel	-284	"SCPI standard error"	"Execution error: Program is currently running."	
Frontpanel	-282	"SCPI standard error"	"Execution error: Invalid program name."	
Frontpanel	-281	"SCPI standard error"	"Execution error: Cannot create program."	
Frontpanel	-256	"SCPI standard error"	"Execution error: File not found."	
Frontpanel	-253	"SCPI standard error"	"Execution error: Media is corrupted."	
Frontpanel	-240	"SCPI standard error"	"Execution error: Hardware error."	
Frontpanel	-224	"SCPI standard error"	"Execution error: Illegal parameter value."	
Frontpanel	-222	"SCPI standard error"	"Execution error: Argument out of range."	
Frontpanel	-221	"SCPI standard error"	"Execution error: Conflict in configuration setting."	
Frontpanel	-203	"SCPI standard error"	"Execution error: Permission denied."	
Frontpanel	-158	"SCPI standard error"	"Command error: String data is not allowed."	
Frontpanel	-138	"SCPI standard error"	"Command error: Numeric suffix is invalid."	

Source	Code	Type	Description	Possible cause
Frontpanel	-131	"SCPI standard error"	"Command error: Numeric suffix is out of range."	
Frontpanel	-113	"SCPI standard error"	"Command error: Undefined header."	
Frontpanel	-109	"SCPI standard error"	"Command error: Invalid number of parameters."	
Frontpanel	-108	"SCPI standard error"	"Command error: Parameters error."	
Frontpanel	-103	"SCPI standard error"	"Command error: Invalid separator."	
Frontpanel	-102	"SCPI standard error"	"Command error: Syntax error."	
Frontpanel	18	"Error"	"Unavailable transient element."	
Frontpanel	19	"Error"	"Maximum number of transient elements."	
Frontpanel	21	"Error"	"Internal communication: error during SDO upload."	
Frontpanel	22	"Error"	"Internal communication: error during SDO download."	
Frontpanel	29	"Error"	"USB interface unknown state."	
Frontpanel	31	"Error"	"Interface request packet	Not empty."
Frontpanel	32	"Error"	"Interface request packet	Unknown type"
Frontpanel	33	"Error"	"Interface request packet	Incompatible type."
Frontpanel	34	"Error"	"Interface request packet out of space."	
Frontpanel	35	"Error"	"Interface request packet	Unavailable command request
Frontpanel	36	"Error"	"Interface request packet has invalid arguments."	
Frontpanel	37	"Error"	"Interface response packet out of space."	
Frontpanel	42	"Error"	"Memory in use was removed."	
Frontpanel	47	"Error"	"Front panel is shutting down."	
Frontpanel	48	"Error"	"Fault state cannot be automatically reset."	
Frontpanel	51	"Error"	"The command cannot be executed in auxiliary unit."	
Frontpanel	53	"Error"	"Error during firmware update."	
Frontpanel	54	"Error"	"Calibration coefficient cannot be negative."	
Frontpanel	57	"Error"	"Waveform is not available."	
Frontpanel	58	"Error"	"Waveforms lengths are different between inverter controllers."	
Frontpanel	59	"Error"	"Unit does not exist."	
Frontpanel	60	"Error"	"Cannot read ambient temperature."	
Frontpanel	64	"Error"	"Unexpected reset."	
Frontpanel	65	"Error"	"Front panel is in passive mode."	
Frontpanel	66	"Error"	"Invalid host name."	
Frontpanel	67	"Error"	"DC voltage setpoint cannot change due to waveform saturation."	
Frontpanel	68	"Error"	"AC voltage setpoint cannot change due to waveform saturation."	
Frontpanel	69	"Error"	"Maximum user limit is lower than setpoint."	

Source	Code	Type	Description	Possible cause
Frontpanel	70	"Error"	"Minimum user limit is higher than setpoint."	
Frontpanel	72	"Error"	"Minimum limit is higher than maximum."	
Frontpanel	73	"Error"	"Maximum limit is lower than minimum."	
Frontpanel	75	"Error"	"IP address conflict. May be duplicated."	
Frontpanel	76	"Error"	"Invalid filename."	
Frontpanel	77	"Error"	"External memory storage is not available."	
Frontpanel	78	"Error"	"Datalogger rate not allowed."	
Frontpanel	79	"Error"	"Datalogger is running"	Yyou must stop it to change the configuration
Frontpanel	80	"Error"	"Datalogger execution error."	
Frontpanel	83	"Error"	"Internal error: File system partition blocked."	
Frontpanel	84	"Error"	"Unable to change form while output is enabled."	
Frontpanel	85	"Error"	"Unable to clear one or more fault."	
Frontpanel	86	"Error"	"Unable to enable output. One or more primary stages failed to enable."	
Frontpanel	89	"Error"	"Digital I/Os interface conflict: Remote inhibit is active."	
Frontpanel	90	"Error"	"Digital I/Os interface conflict: Remote enable is active."	
Frontpanel	91	"Error"	"Internal error: Unknown phase mode."	
Frontpanel	92	"Error"	"Unable to disable output. One or more primary stages failed to disable."	
Frontpanel	95	"Error"	"Digital I/Os interface conflict: Serial interface flow control is active."	
Frontpanel	96	"Error"	"Datalogger storage error."	
Frontpanel	97	"Error"	"Output enable in progress."	
Frontpanel	98	"Error"	"DC Voltage not allowed in "AC mode"."	
Frontpanel	99	"Error"	"AC Voltage not allowed in "DC mode"."	
Frontpanel	100	"Error"	"DC voltage setpoint cannot change due to user limit."	
Frontpanel	101	"Error"	"AC voltage setpoint cannot change due to user limit."	
Frontpanel	102	"Error"	"DC voltage setpoint cannot change due to low range."	
Frontpanel	103	"Error"	"AC voltage setpoint cannot change due to low range."	
Frontpanel	104	"Error"	"Waveform change in progress."	
Frontpanel	105	"Error"	"Error changing service name"	
Frontpanel	106	"Error"	"Error getting service name"	
Frontpanel	109	"Error"	"Transient step mode not available on UPC compatible mode."	
Frontpanel	110	"Error"	"System is about to reboot."	
Frontpanel	111	"Error"	"Cannot reboot system."	
Frontpanel	115	"Error"	"Unable to renew the DHCP lease. Changing to Auto-IP mode."	

Source	Code	Type	Description	Possible cause
Frontpanel	116	"Error"	"Failed starting firmware update."	
Frontpanel	117	"Error"	"Unable to execute this action with output enabled."	
Frontpanel	118	"Error"	"Frequency setpoint cannot change due to waveform saturation."	
Frontpanel	119	"Error"	"Frequency setpoint cannot change due to user limit."	
Frontpanel	120	"Error"	"Frequency not allowed in "DC mode"."	
Frontpanel	121	"Error"	"Waveform setpoint cannot change due to waveform saturation."	
Frontpanel	122	"Error"	"Cannot load program. Run PROG:CHECK? for more information."	
Frontpanel	125	"Error"	"Remote inhibit cannot be disabled in this model."	
Frontpanel	126	"Error"	"Line to line measurements only available with sinewaves."	
Frontpanel	127	"Error"	"Digital I/Os interface conflict: Single-Phase relay control is active."	
Frontpanel	128	"Error"	"Digital I/Os interface conflict: Single-Phase relay cannot change with output enabled."	
Frontpanel	129	"Error"	"Digital I/Os interface conflict: Single-Phase relay cannot change due relay closed."	
Frontpanel	130	"Error"	"Unable to disable output. One or more inverter stages failed to disable."	
Frontpanel	131	"Error"	"Cannot set EEPROM field"	
Frontpanel	132	"Error"	"EEPROM field already set"	
Frontpanel	133	"Error"	"Cannot read EEPROM field"	
Frontpanel	148	"Error"	"Serial number mismatch: Front panel does not match power stages."	
Frontpanel	150	"Error"	"Suffix not allowed in single form."	
Frontpanel	151	"Error"	"Suffix not allowed in split form."	
Frontpanel	152	"Error"	"Peak current limit setting is too low for the desired voltage and frequency."	
Frontpanel	153	"Error"	"Program transient trigger input is disabled."	
Frontpanel	154	"Error"	"Steady state not yet stabilized."	
Frontpanel	155	"Error"	"Trigger output not available in this model."	
Frontpanel	156	"Error"	"Trigger input not available in this model."	
Frontpanel	157	"Error"	"Filter size must be an odd number."	
Frontpanel	158	"Error"	"Voltage mode not available in UPC compatible mode."	
Frontpanel	159	"Error"	"Waveform is unique in UPC compatible mode."	
Frontpanel	160	"Error"	"Phase is 180 for split in UPC compatible mode."	
Frontpanel	161	"Error"	"Voltage AC is unique in UPC compatible mode."	
Frontpanel	162	"Error"	"CSC is always disabled during transient in UPC compatible mode."	
Frontpanel	163	"Error"	"Auto RMS is always enabled in UPC compatible mode."	

Source	Code	Type	Description	Possible cause
Frontpanel	166	"Error"	"Unable to set extended voltage because frequency is outside the allowed range."	
Frontpanel	169	"Error"	"Unable to update setpoint because it is outside the allowed range of extended voltage mode."	
Frontpanel	172	"Error"	"Command not allowed during power stage firmware update."	
Frontpanel	173	"Error"	"Cannot change Current RMS Overload mode with output enabled."	
Frontpanel	174	"Error"	"Strobe feature not available in this model."	
Frontpanel	175	"Error"	"Feature not available in this model."	
Frontpanel	176	"Error"	"Setpoints cannot be changed while transient program is running."	
Frontpanel	177	"Error"	"Cycle reset is always enabled in UPC compatible mode."	
Frontpanel	178	"Error"	"Command not available in this unit model."	
Frontpanel	179	"Error"	"Digital output is being used for transformer option."	
Frontpanel	180	"Error"	"Unknown processor type detected. Run unit discovery to recover."	
Frontpanel	181	"Error"	"Undiscovered node detected. Run unit discovery to recover."	
Frontpanel	182	"Error"	"Incorrect parallel unit count"	
Frontpanel	183	"Error"	"Invalid processor type"	
Frontpanel	184	"Error"	"Daisy chain invalid type"	
Frontpanel	185	"Error"	"Undiscovered controller node was detected. "	
Frontpanel	186	"Error"	"No master front panel was detected."	
Frontpanel	187	"Error"	"More than enabled master controller is was detected. Going to inactive state."	
Frontpanel	188	"Error"	"One or more units are not energized or have a failure."	
Frontpanel	189	"Error"	"Incompatible node detected."	
Frontpanel	190	"Error"	"Master unit nodes not found."	
Frontpanel	191	"Error"	"Fastscan failed."	
Frontpanel	192	"Error"	"Undetectable node exists."	
Frontpanel	193	"Error"	"An invalid firmare type exists."	
Frontpanel	501	"Error"	"Frequency is too high to enable xfmr coupling."	
Frontpanel	502	"Error"	"Extended voltage range is not allowed when overload modes are enabled."	
Frontpanel	503	"Error"	"Frequency is too high for extended voltage mode."	
Frontpanel	504	"Error"	"Cannot change extended voltage mode with output enabled."	
Frontpanel	505	"Error"	"Cannot enable current overload mode when extended voltage range is enabled."	
Frontpanel	506	"Error"	"Cannot enable extended frequency when extended voltage range is enabled."	
Frontpanel	509	"Error"	"Setpoint out of range due to extended frequency mode."	

Source	Code	Type	Description	Possible cause
Frontpanel	510	"Error"	"Unable to update setpoint because it is outside the allowed range of extended frequency mode."	
Frontpanel	511	"Error"	"Error during power stage firmware update."	
Frontpanel	512	"Error"	"Phase rotation is always negative in UPC compatible mode."	
Frontpanel	513	"Error"	"Cannot change split phase mode with output enabled."	
Frontpanel	514	"Error"	"Serial port flow control not available in this unit."	
Frontpanel	515	"Error"	"Too many commands per line."	
Frontpanel	518	"Error"	"Cannot change output impedance state with output enabled."	
Frontpanel	519	"Error"	"Cannot change output impedance mode with output enabled."	
Frontpanel	520	"Error"	"Inductive impedance not available in UPC compatible mode."	
Frontpanel	521	"Error"	"Read only file or folder."	
Frontpanel	522	"Error"	"Argument requires more decimals."	
Frontpanel	524	"Error"	"Digital I/Os interface conflict: Serial interface is active."	
Frontpanel	525	"Error"	"New IO firmware available. Must split system in two to perform update."	
Frontpanel	526	"Error"	"Cannot export configurations."	
Frontpanel	527	"Error"	"Cannot import configurations."	
Frontpanel	528	"Error"	"Version mismatch error."	
Frontpanel	529	"Error"	"Internal connection error with the power stage."	
Frontpanel	530	"Error"	"Fault during output enable."	
Frontpanel	531	"Error"	"Incorrect password."	
Frontpanel	533	"Error"	"This setpoint is being set by an analog input."	
Frontpanel	534	"Error"	"Image model not compatible."	
Frontpanel	535	"Error"	"Frontpanel not compatible."	
Frontpanel	536	"Error"	"Cannot convert cycle based transient to time based."	
Frontpanel	537	"Error"	"Cannot load pulse."	
Frontpanel	539	"Error"	"Parameter below minimum saturation."	
Frontpanel	540	"Error"	"Parameter below minimum range."	
Frontpanel	541	"Error"	"Parameter below minimum unit scope."	
Frontpanel	542	"Error"	"Parameter below minimum user limit."	
Frontpanel	543	"Error"	"Parameter below voltage mode."	
Frontpanel	544	"Error"	"Parameter above maximum saturation."	
Frontpanel	545	"Error"	"Parameter above maximum range."	
Frontpanel	546	"Error"	"Parameter above maximum unit scope."	
Frontpanel	547	"Error"	"Parameter above maximum user limit."	
Frontpanel	548	"Error"	"Parameter above voltage mode."	

Source	Code	Type	Description	Possible cause
Frontpanel	549	"Error"	"Locked unit	Please unlock with command SYST:UNLOCK PASSWORD
Frontpanel	550	"Error"	"Unit model changed to ADF."	
Frontpanel	551	"Error"	"Series parallel mode switch not available."	
Frontpanel	552	"Error"	"Series connection requires an even number of units."	
Frontpanel	553	"Error"	"Digital output is being used for series units option."	
Frontpanel	554	"Error"	"Series connection is disabled. A Series connection should be set with SYSTem:SERIES command."	
Frontpanel	555	"Error"	"Transformer option is configured."	
Frontpanel	556	"Error"	"Series connection option is configured."	
Frontpanel	557	"Error"	"Series connection not detected."	
Frontpanel	558	"Error"	"Series connection inhibit."	
Frontpanel	559	"Error"	"Digital input 3 is fixed to series connection inhibit."	
Frontpanel	560	"Error"	"Series connection requires series remote sense board."	
Frontpanel	561	"Error"	"Series connection incorrect units order."	
Frontpanel	562	"Error"	"Series connection protection cannot be disabled."	
Frontpanel	71	"Warning"	"Setpoint reduced due to low range."	
Frontpanel	107	"Warning"	"Redundant segments were combined."	
Frontpanel	108	"Warning"	"Redundant steps were combined."	
Frontpanel	144	"Warning"	"Internal battery needs to be replaced."	
Frontpanel	164	"Warning"	"Warning: CSC is enabled and Auto-RMS is disabled. Output RMS may not be regulated properly."	
Frontpanel	165	"Warning"	"Maximum AC voltage limit was reduced due to extended voltage range."	
Frontpanel	167	"Warning"	"Power limits were reduced due to extended voltage range."	
Frontpanel	168	"Warning"	"AC voltage setpoints and/or AC voltage maximum limit were reduced due to extended voltage range."	
Frontpanel	171	"Warning"	"Warning: Repeated waveform alias."	
Frontpanel	500	"Warning"	"AC voltage setpoint was automatically reduced to 0 Vrms."	
Frontpanel	507	"Warning"	"Power limits were reduced due to extended frequency mode."	
Frontpanel	508	"Warning"	"Current limits were reduced due to extended frequency mode."	
Frontpanel	516	"Warning"	"Resistive impedance was automatically reduced."	
Frontpanel	517	"Warning"	"Inductive impedance was automatically reduced."	
Frontpanel	523	"Warning"	"Warning: Ambient temperature approaching limit."	

Source	Code	Type	Description	Possible cause
Frontpanel	532	"Warning"	"Frontpanel firmware image model do not match frontpanel model."	
Frontpanel	563	"Warning"	"VLL estimation accuracy is lower."	
Frontpanel	331	"Fault"	"Unit discovery fault. Run unit discovery to recover."	
Frontpanel	332	"Fault"	"Undiscovered unit/node detected. Run unit discovery to recover."	
Frontpanel	334	"Fault"	"Power failure."	
Frontpanel	335	"Fault"	"Remote inhibit was issued from remote interface."	
Frontpanel	336	"Fault"	"System about to reboot."	
Frontpanel	338	"Fault"	"One or more inverters did not get enabled."	
Frontpanel	339	"Fault"	"One or more primaries did not get enabled."	
Frontpanel	342	"Fault"	"Mismatch between hardware revision of units in parallel."	
Frontpanel	343	"Fault"	"Power stage firmware update failed. Run SYSTEM:FW:INT:UPDATE:STAT? for more information. Run unit discovery to recover."	
Frontpanel	344	"Fault"	"Firmware update was interrupted"	Recovery is needed. Run unit discovery to recover."
Frontpanel	345	"Fault"	"GPIB hardware not found in this unit."	
Frontpanel	346	"Fault"	"GPIB hardware detected"	Unit model mismatch."
Frontpanel	347	"Fault"	"IO hardware not found in this unit."	
Frontpanel	348	"Fault"	"IO hardware detected"	Unit model mismatch."
Frontpanel	350	"Fault"	"Transformer hardware detected"	Unit model mismatch."
Frontpanel	351	"Fault"	"Ambient temperature exceeded maximum limit."	
Frontpanel	352	"Fault"	"Mismatch between models of units in parallel."	
Frontpanel	353	"Fault"	"Unit model mismatch."	
Frontpanel	355	"Fault"	"Series connection hardware detected"	Unit model mismatch."
Frontpanel	329	"Internal fault"	"Global fault detected."	
Frontpanel	330	"Internal fault"	"Global fault detected. Possible unenergized unit or node."	
Frontpanel	333	"Internal fault"	"Node in non-operational mode. Run unit discovery to recover."	
Frontpanel	337	"Internal fault"	"Missed node."	
Frontpanel	340	"Internal fault"	"Firmware version mismatch. Power stage version is older than expected. Contact technical support."	
Frontpanel	341	"Internal fault"	"Firmware version mismatch. Front panel version is older than expected. Contact technical support."	
Frontpanel	349	"Internal fault"	"Analog inputs cannot be read."	

Source	Code	Type	Description	Possible cause
Frontpanel	354	"Internal fault"	"Digital inputs cannot be read."	
Frontpanel	356	"Internal fault"	"Did not receive MDO 1 - Inverter A."	
Frontpanel	357	"Internal fault"	"Did not receive MDO 2 - Inverter A."	
Frontpanel	358	"Internal fault"	"Did not receive MDO 3 - Inverter A."	
Frontpanel	359	"Internal fault"	"Did not receive MDO 4 - Inverter A."	
Frontpanel	360	"Internal fault"	"Did not receive MDO 5 - Inverter A."	
Frontpanel	361	"Internal fault"	"Did not receive MDO 6 - Inverter A."	
Frontpanel	362	"Internal fault"	"Did not receive MDO 7 - Inverter A."	
Frontpanel	363	"Internal fault"	"Did not receive MDO 8 - Inverter A."	
Frontpanel	364	"Internal fault"	"Did not receive MDO 9 - Inverter A."	
Frontpanel	365	"Internal fault"	"Did not receive MDO 10 - Inverter A."	
Frontpanel	366	"Internal fault"	"Did not receive MDO 1 - Inverter B."	
Frontpanel	367	"Internal fault"	"Did not receive MDO 2 - Inverter B."	
Frontpanel	368	"Internal fault"	"Did not receive MDO 3 - Inverter B."	
Frontpanel	369	"Internal fault"	"Did not receive MDO 4 - Inverter B."	
Frontpanel	370	"Internal fault"	"Did not receive MDO 5 - Inverter B."	
Frontpanel	371	"Internal fault"	"Did not receive MDO 6 - Inverter B."	
Frontpanel	372	"Internal fault"	"Did not receive MDO 7 - Inverter B."	
Frontpanel	373	"Internal fault"	"Did not receive MDO 8 - Inverter B."	
Frontpanel	374	"Internal fault"	"Did not receive MDO 1 - Inverter C."	
Frontpanel	375	"Internal fault"	"Did not receive MDO 2 - Inverter C."	
Frontpanel	376	"Internal fault"	"Did not receive MDO 3 - Inverter C."	
Frontpanel	377	"Internal fault"	"Did not receive MDO 4 - Inverter C."	
Frontpanel	378	"Internal fault"	"Did not receive MDO 5 - Inverter C."	
Frontpanel	379	"Internal fault"	"Did not receive MDO 6 - Inverter C."	
Frontpanel	380	"Internal fault"	"Did not receive MDO 7 - Inverter C."	
Frontpanel	381	"Internal fault"	"Did not receive MDO 8 - Inverter C."	
Frontpanel	1	"Internal error"	"Unknown fault or error."	
Frontpanel	2	"Internal error"	"Cannot initialize command thread."	
Frontpanel	3	"Internal error"	"Cannot initialize global semaphore."	
Frontpanel	4	"Internal error"	"Cannot create SCPI status object."	
Frontpanel	5	"Internal error"	"Cannot create network manager object."	
Frontpanel	6	"Internal error"	"Cannot initialize CANOpen stack."	
Frontpanel	7	"Internal error"	"Cannot initialize process class array."	
Frontpanel	8	"Internal error"	"Cannot initialize local CANOpen object dictionary."	
Frontpanel	9	"Internal error"	"Cannot create FastCGI interface."	
Frontpanel	10	"Internal error"	"Cannot create TCP interface."	
Frontpanel	11	"Internal error"	"Cannot create TELNET interface."	
Frontpanel	12	"Internal error"	"Cannot create UART serial interface."	
Frontpanel	13	"Internal error"	"Cannot create USB serial interface."	

Source	Code	Type	Description	Possible cause
Frontpanel	14	"Internal error"	"Cannot create keyboard interface."	
Frontpanel	15	"Internal error"	"Cannot create front panel interface."	
Frontpanel	16	"Internal error"	"Cannot create SCPI program interface."	
Frontpanel	17	"Internal error"	"Cannot cast process class in runtime."	
Frontpanel	20	"Internal error"	"Unknown operation."	
Frontpanel	23	"Internal error"	"Unavailable node."	
Frontpanel	24	"Internal error"	"Cannot initialize GPIO library."	
Frontpanel	25	"Internal error"	"Process class: not implemented type."	
Frontpanel	25	"Internal error"	"Cannot attach GPIO."	
Frontpanel	26	"Internal error"	"Process class: invalid initialization."	
Frontpanel	27	"Internal error"	"SCPI program dynamic cast."	
Frontpanel	28	"Internal error"	"Cannot initialize node discovery."	
Frontpanel	38	"Internal error"	"Static null pointer."	
Frontpanel	39	"Internal error"	"Cannot create file system object"	
Frontpanel	40	"Internal error"	"Linux system call error"	
Frontpanel	41	"Internal error"	"XML library error."	
Frontpanel	43	"Internal error"	"Cannot create fault manager interface."	
Frontpanel	44	"Internal error"	"Global fault UIO driver."	
Frontpanel	45	"Internal error"	"Global fault interrupt disabled."	
Frontpanel	46	"Internal error"	"Cannot create global fault thread."	
Frontpanel	49	"Internal error"	"Cannot initialize communications reset mutex."	
Frontpanel	50	"Internal error"	"Cannot initialize communications reset condition variable."	
Frontpanel	52	"Internal error"	"Error in internal communications heartbeat."	
Frontpanel	55	"Internal error"	"Cannot initialize waveform manager."	
Frontpanel	61	"Internal error"	"Cannot initialize firmware update manager."	
Frontpanel	62	"Internal error"	"Cannot initialize buffer manager."	
Frontpanel	81	"Internal error"	"Internal error: Socket send error."	
Frontpanel	82	"Internal error"	"Internal error: Interface request packet has incorrect CRC."	
Frontpanel	87	"Internal error"	"Internal error: Cannot get system time."	
Frontpanel	88	"Internal error"	"Internal error: Unknown sequence."	
Frontpanel	93	"Internal error"	"Internal error: Cannot configure timer."	
Frontpanel	94	"Internal error"	"Internal error: Cannot create timer."	
Frontpanel	136	"Internal error"	"NVRAM CRC mismatch"	
Frontpanel	137	"Internal error"	"NVRAM cannot open."	
Frontpanel	138	"Internal error"	"NVRAM cannot close."	
Frontpanel	139	"Internal error"	"NVRAM cannot lock."	
Frontpanel	140	"Internal error"	"NVRAM cannot unlock."	
Frontpanel	141	"Internal error"	"NVRAM cannot read."	

Source	Code	Type	Description	Possible cause
Frontpanel	142	"Internal error"	"NVRAM cannot write."	
Frontpanel	143	"Internal error"	"Cannot reset EEPROM."	
Frontpanel	145	"Internal error"	"NVRAM hardware error. Using temporal storage."	
Frontpanel	146	"Internal error"	"Invalid command ID."	
Frontpanel	147	"Internal error"	"Command argument not exist."	
Frontpanel	149	"Internal error"	"This does not seems to be a front panel."	
Frontpanel	2000	"Internal error"	"Command request argument: argument cannot be null."	
Frontpanel	2001	"Internal error"	"Command request argument: cannot parse unknown argument."	
Frontpanel	2002	"Internal error"	"Command request argument: cannot parse argument."	
Frontpanel	2003	"Internal error"	"Command request argument: cannot append string to non string argument."	
Frontpanel	2004	"Internal error"	"Command request argument: cannot serialize due to small buffer."	
Frontpanel	2005	"Internal error"	"Command request argument: cannot deserialize due to small buffer."	
Frontpanel	2006	"Internal error"	"Command request argument: cannot get string due non string argument."	
Frontpanel	2007	"Internal error"	"EEPROM Data: Write header error."	
Frontpanel	2008	"Internal error"	"EEPROM Data: Write data error."	
Frontpanel	2009	"Internal error"	"EEPROM Data: Data too big."	
Frontpanel	2010	"Internal error"	"EEPROM Data: Cannot open temporal file."	
Frontpanel	2011	"Internal error"	"EEPROM Data: Close error."	
Frontpanel	2012	"Internal error"	"EEPROM Data: Offset error."	
Frontpanel	2013	"Internal error"	"EEPROM Data: Read error."	
Frontpanel	2014	"Internal error"	"Transformer: Corrupted internal database."	
Frontpanel	2015	"Internal error"	"XFMR ratio not found."	
Frontpanel	2016	"Internal error"	"Coupling cannot be changed with output enabled."	
Frontpanel	2017	"Internal error"	"XFMR ratio cannot be changed with output enabled."	
Frontpanel	2018	"Internal error"	"Transformer option not available in this model."	
Frontpanel	2019	"Internal error"	"XFMR ratio is disabled. A XFMR ratio should be set with SYSTEM:XFMR RATIO command."	
Frontpanel	2020	"Internal error"	"Transformer control circuits not detected."	
Frontpanel	2021	"Internal error"	"DC voltage not allowed with transformer coupling."	
Frontpanel	2022	"Internal error"	"Command request: command request cannot be null."	
Frontpanel	2023	"Internal error"	"Command request: command request argument is null."	
Frontpanel	2024	"Internal error"	"Command request: argument is null."	
Frontpanel	2025	"Internal error"	"Command request: argument number is null."	

Source	Code	Type	Description	Possible cause
Frontpanel	2026	"Internal error"	"Command request: argument number does not exist."	
Frontpanel	2027	"Internal error"	"Command request: there are no arguments."	
Frontpanel	2028	"Internal error"	"Command request: cannot serialize due small buffer."	
Frontpanel	2029	"Internal error"	"Command request: cannot deserialize due small buffer."	
Frontpanel	2030	"Internal error"	"Command request: cannot deserialize due argument count mismatch."	
Frontpanel	2031	"Internal error"	"Command request: cannot deserialize due size mismatch."	
Frontpanel	2032	"Internal error"	"Command request vector: request number does not exist."	
Frontpanel	2033	"Internal error"	"Command request vector: request number is null."	
Frontpanel	2034	"Internal error"	"Command request vector: request is null."	
Frontpanel	2035	"Internal error"	"Command request vector: vector is empty."	
Frontpanel	2036	"Internal error"	"Command request vector: cannot serialize due small buffer."	
Frontpanel	2037	"Internal error"	"Command request vector: cannot deserialize due small buffer."	
Frontpanel	2038	"Internal error"	"Command request vector: cannot deserialize due command count mismatch."	
Frontpanel	2039	"Internal error"	"Command request vector: cannot deserialize due size mismatch."	
Frontpanel	2040	"Internal error"	"Interface request packet: cannot deserialize due size mismatch."	
Frontpanel	2041	"Internal error"	"Command thread: cannot post command semaphore."	
Frontpanel	2042	"Internal error"	"Command thread: cannot initialize command semaphore."	
Frontpanel	2043	"Internal error"	"Debug message file: seek file error."	
Frontpanel	2044	"Internal error"	"Debug message file: tell file error."	
Frontpanel	2045	"Internal error"	"Debug message file: close file error."	
Frontpanel	2046	"Internal error"	"Debug message file: open file error."	
Frontpanel	2047	"Internal error"	"Debug message file: write file error."	
Frontpanel	2048	"Internal error"	"Debug message file: flush file error."	
Frontpanel	2049	"Internal error"	"Debug message file: unlink file error."	
Frontpanel	2050	"Internal error"	"Debug message ring buffer: cannot allocate buffer."	
Frontpanel	2051	"Internal error"	"Debug message ring buffer: seek file error."	
Frontpanel	2052	"Internal error"	"Debug message ring buffer: tell file error."	
Frontpanel	2053	"Internal error"	"Debug message ring buffer: close file error."	
Frontpanel	2054	"Internal error"	"Debug message ring buffer: open file error."	
Frontpanel	2055	"Internal error"	"Debug message ring buffer: write file error."	

Source	Code	Type	Description	Possible cause
Frontpanel	2056	"Internal error"	"Debug message ring buffer: flush file error."	
Frontpanel	2057	"Internal error"	"Debug message ring buffer: unlink file error."	
Frontpanel	2058	"Internal error"	"Debug message system: print error failed."	
Frontpanel	2059	"Internal error"	"Debug message system: print output failed."	
Frontpanel	2060	"Internal error"	"Debug: cannot get core limit."	
Frontpanel	2061	"Internal error"	"Debug: cannot set core limit."	
Frontpanel	2062	"Internal error"	"Debug: cannot initialize mutex attributes."	
Frontpanel	2063	"Internal error"	"Debug: cannot set mutex attributes."	
Frontpanel	2064	"Internal error"	"Debug: cannot initialize mutex."	
Frontpanel	2065	"Internal error"	"Debug: cannot destroy mutex."	
Frontpanel	2066	"Internal error"	"Debug: cannot lock mutex."	
Frontpanel	2067	"Internal error"	"Debug: cannot unlock mutex."	
Frontpanel	2068	"Internal error"	"Debug: cannot allocate debug message system."	
Frontpanel	2069	"Internal error"	"Debug: cannot allocate debug message ring buffer."	
Frontpanel	2070	"Internal error"	"Debug: cannot allocate debug message file."	
Frontpanel	2071	"Internal error"	"Timer: cannot initialize mutex attributes."	
Frontpanel	2072	"Internal error"	"Timer: cannot set mutex attributes."	
Frontpanel	2073	"Internal error"	"Timer: cannot initialize mutex."	
Frontpanel	2074	"Internal error"	"Timer: cannot destroy mutex."	
Frontpanel	2075	"Internal error"	"Timer: cannot lock mutex."	
Frontpanel	2076	"Internal error"	"Timer: cannot unlock mutex."	
Frontpanel	2077	"Internal error"	"Timer: cannot allocate mark."	
Frontpanel	2078	"Internal error"	"Timer: cannot get time."	
Frontpanel	2079	"Internal error"	"Timing: cannot initialize mutex attributes."	
Frontpanel	2080	"Internal error"	"Timing: cannot set mutex attributes."	
Frontpanel	2081	"Internal error"	"Timing: cannot initialize mutex."	
Frontpanel	2082	"Internal error"	"Timing: cannot destroy mutex."	
Frontpanel	2083	"Internal error"	"Timing: cannot lock mutex."	
Frontpanel	2084	"Internal error"	"Timing: cannot unlock mutex."	
Frontpanel	2085	"Internal error"	"Timing: cannot allocate timer."	
Frontpanel	2086	"Internal error"	"Timing: timer not found."	
Frontpanel	2087	"Internal error"	"Command response item: cannot get string of non string type."	
Frontpanel	2088	"Internal error"	"Command response item: cannot get two items."	
Frontpanel	2089	"Internal error"	"Command response item: cannot get three items."	
Frontpanel	2090	"Internal error"	"Command response item: cannot get item."	

Source	Code	Type	Description	Possible cause
Frontpanel	2091	"Internal error"	"Command response item: cannot set null item."	
Frontpanel	2092	"Internal error"	"Command response item: cannot set item with null data."	
Frontpanel	2093	"Internal error"	"Command response item: cannot set null item vector."	
Frontpanel	2094	"Internal error"	"Command response item: cannot append item of different type."	
Frontpanel	2095	"Internal error"	"Command response item: item not compatible."	
Frontpanel	2096	"Internal error"	"Command response item: cannot serialize due small buffer."	
Frontpanel	2097	"Internal error"	"Command response item: cannot deserialize due small buffer."	
Frontpanel	2098	"Internal error"	"Command response vector: vector is empty."	
Frontpanel	2099	"Internal error"	"Command response vector: last response is null."	
Frontpanel	2100	"Internal error"	"Command response vector: response does not exist."	
Frontpanel	2101	"Internal error"	"Command response vector: cannot serialize due small buffer"	
Frontpanel	2102	"Internal error"	"Command response vector: cannot deserialize due response count mismatch."	
Frontpanel	2103	"Internal error"	"Command response vector: cannot deserialize due size mismatch."	
Frontpanel	2104	"Internal error"	"Command response: cannot set null response."	
Frontpanel	2105	"Internal error"	"Command response: cannot append null data."	
Frontpanel	2106	"Internal error"	"Command response: vector is empty."	
Frontpanel	2107	"Internal error"	"Command response: last item is null."	
Frontpanel	2108	"Internal error"	"Command response: item does not exist."	
Frontpanel	2109	"Internal error"	"Command response: cannot serialize due small buffer."	
Frontpanel	2110	"Internal error"	"Command response: cannot deserialize due item count mismatch."	
Frontpanel	2111	"Internal error"	"Command response: cannot deserialize due size mismatch."	
Frontpanel	2112	"Internal error"	"Interface response packet: cannot convert due small buffer."	
Frontpanel	2113	"Internal error"	"Interface response packet: cannot deserialize due size mismatch."	
Frontpanel	2114	"Internal error"	"DB9 GPIOs: owner not allowed."	
Frontpanel	2115	"Internal error"	"Signals: system call sigemptyset."	
Frontpanel	2116	"Internal error"	"Signals: system call sigaddset."	
Frontpanel	2117	"Internal error"	"Signals: system call pthread_sigmask."	
Frontpanel	2118	"Internal error"	"Signals: system call sigaction."	
Frontpanel	2119	"Internal error"	"Signals: cannot initialize destructor semaphore."	
Frontpanel	2120	"Internal error"	"Signals: cannot destroy destructor semaphore."	

Source	Code	Type	Description	Possible cause
Frontpanel	2121	"Internal error"	"Thread: cannot initialize mutex."	
Frontpanel	2122	"Internal error"	"Thread: cannot create thread."	
Frontpanel	2123	"Internal error"	"Thread: cannot cancel thread."	
Frontpanel	2124	"Internal error"	"Thread: cannot join thread."	
Frontpanel	2125	"Internal error"	"NVRAM: field is not double."	
Frontpanel	2126	"Internal error"	"NVRAM: field is not bool."	
Frontpanel	2127	"Internal error"	"NVRAM: field is not unsigned char."	
Frontpanel	2128	"Internal error"	"XML file: default document is null."	
Frontpanel	2129	"Internal error"	"XML file: cannot lock mutex."	
Frontpanel	2130	"Internal error"	"XML file: cannot unlock mutex."	
Frontpanel	2131	"Internal error"	"XML file: cannot lock file."	
Frontpanel	2132	"Internal error"	"XML file: cannot truncate file."	
Frontpanel	2133	"Internal error"	"XML file: cannot seek file."	
Frontpanel	2134	"Internal error"	"XML file: cannot write file."	
Frontpanel	2135	"Internal error"	"XML file: cannot flush file."	
Frontpanel	2136	"Internal error"	"XML file: cannot sync file."	
Frontpanel	2137	"Internal error"	"XML file: cannot initialize mutex attributes."	
Frontpanel	2138	"Internal error"	"XML file: cannot set mutex attribute."	
Frontpanel	2139	"Internal error"	"XML file: cannot initialize mutex."	
Frontpanel	2140	"Internal error"	"XML file: cannot unlink file."	
Frontpanel	2141	"Internal error"	"XML file: cannot convert to double."	
Frontpanel	2142	"Internal error"	"XML file: cannot convert to float."	
Frontpanel	2143	"Internal error"	"XML file: cannot convert to int."	
Frontpanel	2144	"Internal error"	"XML file: cannot convert to unsigned int."	
Frontpanel	2145	"Internal error"	"XML file: cannot convert to bool."	
Frontpanel	2146	"Internal error"	"XML file: cannot convert attribute."	
Frontpanel	2147	"Internal error"	"XML file: cannot convert attribute to bool"	
Frontpanel	2148	"Internal error"	"XML file: document is null."	
Frontpanel	2149	"Internal error"	"XML file: element is null."	
Frontpanel	2150	"Internal error"	"XML file: element data is null."	
Frontpanel	2151	"Internal error"	"XML file: attribute is null."	
Frontpanel	2152	"Internal error"	"XML file: attribute data is null."	
Frontpanel	2153	"Internal error"	"XML file: system call access failed."	
Frontpanel	2154	"Internal error"	"XML file: cannot rename file."	
Frontpanel	2155	"Internal error"	"XML file: cannot allocate document."	
Frontpanel	2156	"Internal error"	"XML file: CRC mismatch."	
Frontpanel	2157	"Internal error"	"XML file: version mismatch."	
Frontpanel	2158	"Internal error"	"XML file: cannot amend file."	
Frontpanel	2159	"Internal error"	"XML file: data out of range."	
Frontpanel	2160	"Internal error"	"XML file: cannot insert element."	

Source	Code	Type	Description	Possible cause
Frontpanel	2161	"Internal error"	"XML file: cannot clone element."	
Frontpanel	2162	"Internal error"	"CAN interface: cannot initialize mutex."	
Frontpanel	2163	"Internal error"	"CAN open stack: cannot initialize running mutex."	
Frontpanel	2164	"Internal error"	"CAN open stack: cannot initialize reset mutex."	
Frontpanel	2165	"Internal error"	"CAN open stack: cannot initialize CO mutex."	
Frontpanel	2166	"Internal error"	"CAN open stack: cannot initialize READ mutex."	
Frontpanel	2167	"Internal error"	"CAN open stack: cannot destroy CO mutex."	
Frontpanel	2168	"Internal error"	"CAN open stack: cannot destroy reset mutex."	
Frontpanel	2169	"Internal error"	"CAN open stack: cannot destroy running mutex."	
Frontpanel	2170	"Internal error"	"CAN open stack: cannot initialize CO."	
Frontpanel	2171	"Internal error"	"CAN open stack: cannot create timer thread."	
Frontpanel	2172	"Internal error"	"CAN open stack: cannot create RX thread."	
Frontpanel	2173	"Internal error"	"CAN open stack: cannot CAN socket."	
Frontpanel	2174	"Internal error"	"CAN open stack: cannot configure CAN socket."	
Frontpanel	2175	"Internal error"	"CAN open stack: cannot bind CAN socket."	
Frontpanel	2176	"Internal error"	"CAN open stack: cannot close CAN socket."	
Frontpanel	2177	"Internal error"	"CAN open stack: cannot write CAN socket."	
Frontpanel	2178	"Internal error"	"CAN open stack: write CAN socket size mismatch."	
Frontpanel	2179	"Internal error"	"CAN open stack: CAN socket not initialized."	
Frontpanel	2180	"Internal error"	"CAN open stack: cannot initialize CO timer semaphore."	
Frontpanel	2181	"Internal error"	"CAN open stack: cannot destroy CO timer semaphore."	
Frontpanel	2182	"Internal error"	"CAN main: cannot initialize background semaphore mutex."	
Frontpanel	2183	"Internal error"	"CAN main: cannot destroy background semaphore mutex."	
Frontpanel	2184	"Internal error"	"CAN main: cannot initialize background semaphore."	
Frontpanel	2185	"Internal error"	"CAN main: cannot destroy background semaphore."	
Frontpanel	2186	"Internal error"	"Discovery: cannot initialize daisy chain GPIO."	
Frontpanel	2187	"Internal error"	"Discovery: daisy chain GPIO not initialized."	
Frontpanel	2188	"Internal error"	"Discovery: cannot get processor types due small vector."	
Frontpanel	2189	"Internal error"	"Discovery: cannot get inverters due small vector."	
Frontpanel	2190	"Internal error"	"Discovery: cannot get primaries due small vector."	
Frontpanel	2191	"Internal error"	"Discovery: cannot allocate discovery."	

Source	Code	Type	Description	Possible cause
Frontpanel	2192	"Internal error"	"DSP commands: NMT."	
Frontpanel	2193	"Internal error"	"DSP commands: SDO download."	
Frontpanel	2194	"Internal error"	"DSP commands: SDO upload."	
Frontpanel	2195	"Internal error"	"DSP commands: LSS INCRS."	
Frontpanel	2196	"Internal error"	"DSP commands: LSS SSDC."	
Frontpanel	2197	"Internal error"	"DSP commands: LSS CNI."	
Frontpanel	2198	"Internal error"	"DSP commands: LSS SC."	
Frontpanel	2199	"Internal error"	"DSP commands: LSS FS."	
Frontpanel	2200	"Internal error"	"DSP commands: LSS PPSTFS."	
Frontpanel	2201	"Internal error"	"DSP commands: invalid node ID."	
Frontpanel	2202	"Internal error"	"DSP commands: invalid DSP type."	
Frontpanel	2203	"Internal error"	"DSP commands: invalid mapping number."	
Frontpanel	2204	"Internal error"	"DSP commands: invalid COB ID."	
Frontpanel	2205	"Internal error"	"DSP commands: invalid heart beat number."	
Frontpanel	2206	"Internal error"	"DSP commands: invalid tries number."	
Frontpanel	2207	"Internal error"	"DSP commands: read SDO buffer length."	
Frontpanel	2208	"Internal error"	"DSP commands: read bootloader DSP types."	
Frontpanel	2209	"Internal error"	"DSP commands: read bootloader state."	
Frontpanel	2210	"Internal error"	"DSP update commands: flag for update."	
Frontpanel	2211	"Internal error"	"DSP update commands: check device type."	
Frontpanel	2212	"Internal error"	"DSP update commands: check bootloader update state."	
Frontpanel	2213	"Internal error"	"DSP update commands: unlock flash CSM."	
Frontpanel	2214	"Internal error"	"DSP update commands: lock flash CSM."	
Frontpanel	2215	"Internal error"	"DSP update commands: erase flash sector."	
Frontpanel	2216	"Internal error"	"DSP update commands: write flash block."	
Frontpanel	2217	"Internal error"	"DSP update commands: firmware run."	
Frontpanel	2218	"Internal error"	"Condition comparison: unknown condition."	
Frontpanel	2219	"Internal error"	"Observer program: SCPI program not initialized."	
Frontpanel	2220	"Internal error"	"Command vector: invalid initialization order."	
Frontpanel	2221	"Internal error"	"Command vector: incomplete initialization."	
Frontpanel	2222	"Internal error"	"Observer vector: invalid initialization order."	
Frontpanel	2223	"Internal error"	"Observer vector: incomplete initialization."	
Frontpanel	2224	"Internal error"	"Operation file system: XML file not initialized."	
Frontpanel	2225	"Internal error"	"Operation SDO: cannot get node ID."	
Frontpanel	2226	"Internal error"	"Operation generic: command ID vector empty."	

Source	Code	Type	Description	Possible cause
Frontpanel	2227	"Internal error"	"Operation IEEE4882: long IDN string."	
Frontpanel	2228	"Internal error"	"Operation system: DB9 GPIOs invalid state."	
Frontpanel	2229	"Internal error"	"Operation source: DB9 GPIOs invalid state."	
Frontpanel	2230	"Internal error"	"Operation source: waveform invalid state."	
Frontpanel	2231	"Internal error"	"Operation source: XML configuration file not initialized."	
Frontpanel	2232	"Internal error"	"Operation source: XML program file not initialized."	
Frontpanel	2233	"Internal error"	"Operation simulation: invalid variable ID."	
Frontpanel	2234	"Internal error"	"Operation program: invalid transient status"	
Frontpanel	2235	"Internal error"	"Operation program: command not available."	
Frontpanel	2236	"Internal error"	"Firmware update manager: firmware up to date."	
Frontpanel	2237	"Internal error"	"DSP firmware update log: mutex lock error."	
Frontpanel	2238	"Internal error"	"DSP firmware update log: mutex unlock error."	
Frontpanel	2239	"Internal error"	"DSP firmware update log: error opening log file."	
Frontpanel	2240	"Internal error"	"DSP firmware update log: error flushing log file."	
Frontpanel	2241	"Internal error"	"DSP firmware update log: error closing log file."	
Frontpanel	2242	"Internal error"	"DSP firmware update log: error writing log file."	
Frontpanel	2243	"Internal error"	"DSP firmware update log: no file open to write."	
Frontpanel	2244	"Internal error"	"DSP firmware update log: class null."	
Frontpanel	2245	"Internal error"	"Application: invalid application command."	
Frontpanel	2246	"Internal error"	"Application: cannot initialize running mutex."	
Frontpanel	2247	"Internal error"	"Application: cannot initialize application mutex."	
Frontpanel	2248	"Internal error"	"Application: cannot create timer."	
Frontpanel	2249	"Internal error"	"Application: cannot configure timer."	
Frontpanel	2250	"Internal error"	"Application: cannot close timer."	
Frontpanel	2251	"Internal error"	"XML handler: cannot load XML."	
Frontpanel	2252	"Internal error"	"Application: cannot save XML."	
Frontpanel	2253	"Internal error"	"Avahi XML: folder does not exist."	
Frontpanel	2254	"Internal error"	"Avahi XML: file does not exist."	
Frontpanel	2255	"Internal error"	"Avahi XML: invalid field number."	
Frontpanel	2256	"Internal error"	"Network manager: thread not initialized."	
Frontpanel	2257	"Internal error"	"Network manager: invalid variable ID."	
Frontpanel	2258	"Internal error"	"Network manager: invalid configuration type."	
Frontpanel	2259	"Internal error"	"Network manager: netconfig call failed."	

Source	Code	Type	Description	Possible cause
Frontpanel	2260	"Internal error"	"Network manager: avahi call failed."	
Frontpanel	2261	"Internal error"	"Network manager: udhcp call failed."	
Frontpanel	2262	"Internal error"	"Network manager: netconfig field not found."	
Frontpanel	2263	"Internal error"	"Network manager: invalid service name."	
Frontpanel	2264	"Internal error"	"Network manager: avahi close process."	
Frontpanel	2265	"Internal error"	"External interface: invalid socket path."	
Frontpanel	2266	"Internal error"	"External interface: cannot create from socket."	
Frontpanel	2267	"Internal error"	"External interface: cannot bind from socket."	
Frontpanel	2268	"Internal error"	"External interface: cannot listen from socket."	
Frontpanel	2269	"Internal error"	"External interface: cannot create to socket."	
Frontpanel	2270	"Internal error"	"External interface: cannot bind to socket."	
Frontpanel	2271	"Internal error"	"External interface: cannot listen to socket."	
Frontpanel	2272	"Internal error"	"External interface: cannot initialize to socket mutex."	
Frontpanel	2273	"Internal error"	"External interface: cannot allocate thread."	
Frontpanel	2274	"Internal error"	"External interface: invalid packet type."	
Frontpanel	2275	"Internal error"	"External interface: invalid response type."	
Frontpanel	2276	"Internal error"	"XML SCPI program file: buffer is null."	
Frontpanel	2277	"Internal error"	"XML SCPI program file: buffer is small."	
Frontpanel	2278	"Internal error"	"Program is undefined."	
Frontpanel	2279	"Internal error"	"XML SCPI program file: element is null."	
Frontpanel	2280	"Internal error"	"EEPROM: call failed."	
Frontpanel	2281	"Internal error"	"EEPROM: field not found."	
Frontpanel	2282	"Internal error"	"Memories: invalid folder."	
Frontpanel	2283	"Internal error"	"Memories: invalid name."	
Frontpanel	2284	"Internal error"	"XML access file: invalid IP."	
Frontpanel	2285	"Internal error"	"XML access file: invalid alias size."	
Frontpanel	2286	"Internal error"	"XML access file: cannot convert to bool."	
Frontpanel	2287	"Internal error"	"XML access file: invalid tag."	
Frontpanel	2288	"Internal error"	"Temperature: cannot open file."	
Frontpanel	2289	"Internal error"	"Temperature: file not opened."	
Frontpanel	2290	"Internal error"	"Temperature: cannot seek file."	
Frontpanel	2291	"Internal error"	"Temperature: cannot read file."	
Frontpanel	2292	"Internal error"	"Remote: DB9 GPIO not initialized."	
Frontpanel	2293	"Internal error"	"Remote: cannot open UIO."	
Frontpanel	2294	"Internal error"	"Remote: cannot write UIO."	
Frontpanel	2295	"Internal error"	"Interface vector: cannot initialize mutex attributes."	
Frontpanel	2296	"Internal error"	"Interface vector: cannot set mutex attributes."	

Source	Code	Type	Description	Possible cause
Frontpanel	2297	"Internal error"	"Interface vector: cannot initialize mutex."	
Frontpanel	2298	"Internal error"	"Interface vector: cannot allocate VXI interface."	
Frontpanel	2299	"Internal error"	"Interface vector: cannot lock mutex."	
Frontpanel	2300	"Internal error"	"Interface vector: cannot unlock mutex."	
Frontpanel	2301	"Internal error"	"SCPI program: destination program cannot be manual mode."	
Frontpanel	2302	"Internal error"	"SCPI program: invalid define string."	
Frontpanel	2303	"Internal error"	"SCPI program: missing voltage A."	
Frontpanel	2304	"Internal error"	"SCPI program: missing voltage B."	
Frontpanel	2305	"Internal error"	"Cannot get waveform field."	
Frontpanel	2306	"Internal error"	"Cannot delete waveform in use."	
Frontpanel	2307	"Internal error"	"Waveform #1 cannot be deleted or modified."	
Frontpanel	2308	"Internal error"	"Sequential interface: cannot initialize command executed semaphore."	
Frontpanel	2309	"Internal error"	"Sequential interface: cannot initialize execute command semaphore."	
Frontpanel	2310	"Internal error"	"Sequential interface: cannot initialize pending commands mutex."	
Frontpanel	2311	"Internal error"	"IEEE488.2 status: cannot initialize mutex."	
Frontpanel	2312	"Internal error"	"IEEE488.2 status: item does not exist."	
Frontpanel	2313	"Internal error"	"Fault manager: MDO not received."	
Frontpanel	2314	"Internal error"	"Measurement logger manager: cannot write file."	
Frontpanel	2315	"Internal error"	"Synchronization: cannot initialize operation complete mutex."	
Frontpanel	2316	"Internal error"	"Synchronization: cannot initialize operation complete mutex attributes."	
Frontpanel	2317	"Internal error"	"Synchronization: cannot set operation complete mutex attributes."	
Frontpanel	2318	"Internal error"	"Synchronization: cannot initialize operation complete condition variable."	
Frontpanel	2319	"Internal error"	"SCPI parser: cannot initialize mutex."	
Frontpanel	2320	"Internal error"	"SCPI parser: cannot lock mutex."	
Frontpanel	2321	"Internal error"	"SCPI parser: cannot unlock mutex."	
Frontpanel	113	"Internal warning"	"Missed second heartbeat."	
Frontpanel	114	"Internal warning"	"Missed first heartbeat."	
Frontpanel	123	"Internal warning"	"Warning: input voltage in EEPROM does not match the Primary DSP. Using DSP value."	
Frontpanel	0	"Success"	"No error"	
Inverter	265	"Fault"	"Inverter gate driver fault."	
Inverter	266	"Fault"	"Internal bias supply fault."	
Inverter	267	"Fault"	"No waveform loaded. Load waveform before enabling arbitrary waveform mode."	
Inverter	268	"Fault"	"Exceeded RMS current limit."	
Inverter	269	"Fault"	"Exceeded active power limit."	

Source	Code	Type	Description	Possible cause
Inverter	270	"Fault"	"Exceeded apparent power limit."	
Inverter	271	"Fault"	"Internal SCIA communication error."	
Inverter	272	"Fault"	"Internal McBSP communication CRC error."	
Inverter	273	"Fault"	"Inverter current negative peak protection."	
Inverter	274	"Fault"	"Inverter current positive peak protection."	
Inverter	275	"Fault"	"DC bus voltage minimum limit exceeded."	
Inverter	276	"Fault"	"DC bus voltage maximum limit exceeded."	
Inverter	277	"Fault"	"Temperature protection	Mmaximum limit
Inverter	278	"Fault"	"Temperature protection	Minimum limit
Inverter	279	"Fault"	"Output relay voltage protection	Minimum limit
Inverter	280	"Fault"	"Output relay voltage protection	Maximum limit
Inverter	281	"Fault"	"Output terminals common mode voltage protection	Minimum limit
Inverter	282	"Fault"	"Output terminals common mode voltage protection	Maximum limit
Inverter	283	"Fault"	"Inductor current RMS protection	Exceeded maximum limit for too long
Inverter	284	"Fault"	"Inductor current DC protection	Exceeded maximum limit for too long
Inverter	285	"Fault"	"Global fault input signal detected."	
Inverter	286	"Fault"	"Fan under voltage protection."	
Inverter	287	"Fault"	"Inductor current cycle-by-cycle protection trip limit."	
Inverter	288	"Fault"	"Fan current consumption is abnormal	Fan may be blocked
Inverter	292	"Fault"	"Output current has too much high frequency content	Possible oscillation. RQ monitor fault
Inverter	293	"Fault"	"Controller missed heartbeats from master front panel."	
Inverter	294	"Fault"	"Output over-voltage protection."	
Inverter	296	"Fault"	"Output current peak protection."	
Inverter	297	"Fault"	"Remote voltage sensing fault."	
Inverter	298	"Fault"	"Internal capacitors over-current protection."	
Inverter	299	"Fault"	"Internal bus over-voltage protection. Possible regenerative load."	
Inverter	300	"Fault"	"CSC loop has saturated"	
Inverter	301	"Fault"	"Output current overload. RMS current exceeded limit."	
Inverter	302	"Fault"	"Internal muxed ADC protection fault."	
Inverter	303	"Fault"	"Internal fan current regulation fault."	
Inverter	304	"Fault"	"Parallel units model mismatch."	
Inverter	289	"Internal fault"	"Hardware revision does not match expected by firmware. Firmware must be reloaded."	

Source	Code	Type	Description	Possible cause
Inverter	290	"Internal fault"	"Invalid node ID. Run unit discovery to recover."	
Inverter	291	"Internal fault"	"Incorrect DSP type detected. Cycle-power to re-try."	
Inverter	295	"Internal fault"	"Invalid constants loaded from EEPROM."	
Inverter	326	"Internal fault"	"Controller is not in operational node."	
Inverter	327	"Internal fault"	"Missing controller node."	
Inverter	328	"Internal fault"	"Cannot read fault information."	
Primary	200	"Fault"	"LLC primary/auxiliary current peak limit exceeded."	
Primary	201	"Fault"	"LLC/PFC gate driver fault or hardware OVP."	
Primary	202	"Fault"	"Controller missed heartbeats from master front panel."	
Primary	203	"Fault"	"LLC primary current average limit exceeded."	
Primary	204	"Fault"	"LLC auxiliary current average limit exceeded."	
Primary	205	"Fault"	"PFC current peak limit exceeded."	
Primary	206	"Fault"	"PFC DC bus voltage limit exceeded."	
Primary	207	"Fault"	"Gate driver fault"	Input buck converter
Primary	208	"Fault"	"Input buck switching time."	
Primary	209	"Fault"	"AC input current exceeded RMS limit for too long."	
Primary	210	"Fault"	"Unbalanced current in PFC boost converters."	
Primary	211	"Fault"	"PFC efficiency protection."	
Primary	212	"Fault"	"AC input: voltage is below minimum."	
Primary	213	"Fault"	"AC input: missing phase."	
Primary	214	"Fault"	"PFC DC bus voltage regulation lost."	
Primary	215	"Fault"	"PFC DC bus voltage limit exceeded. CLA OVP Trip"	
Primary	216	"Fault"	"Temperature 1 protection (input stage)"	Exceeded maximum limit
Primary	217	"Fault"	"Temperature 1 protection (input stage)"	Exceeded minimum limit
Primary	218	"Fault"	"Temperature 2 protection (PFC/LLC)"	Exceeded maximum limit
Primary	219	"Fault"	"Temperature 2 protection (PFC/LLC)"	Exceeded minimum limit
Primary	220	"Fault"	"Temperature 3 protection (PFC/LLC)"	Exceeded maximum limit
Primary	221	"Fault"	"Temperature 3 protection (PFC/LLC) exceeded minimum limit."	
Primary	222	"Fault"	"Temperature 4 protection (main transformer)"	Exceeded maximum limit
Primary	223	"Fault"	"Temperature 4 protection (main transformer)"	Exceeded minimum limit
Primary	224	"Fault"	"Internal bias supply fault."	
Primary	230	"Fault"	"PFC output current peak protection."	

Source	Code	Type	Description	Possible cause
Primary	231	"Fault"	"PFC output current slow protection"	
Primary	232	"Fault"	"AC input: voltage is above maximum."	
Primary	234	"Fault"	"Firmware task execution error."	
Primary	225	"Internal fault"	"Global fault input signal detected."	
Primary	226	"Internal fault"	"Hardware does not match input voltage setting."	
Primary	227	"Internal fault"	"Primary capacitor board not detected."	
Primary	228	"Internal fault"	"Invalid node ID. Run unit discovery to recover."	
Primary	229	"Internal fault"	"Incorrect DSP type detected. Cycle-power to re-try."	
Primary	233	"Internal fault"	"Invalid constants loaded from EEPROM."	
Primary	261	"Internal fault"	"Controller is not in operational node."	
Primary	262	"Internal fault"	"Missing controller node."	
Primary	263	"Internal fault"	"Cannot read fault information."	
IO board	399	"Fault"	"Transformer coupling / series connection circuits hardware fault."	
IO board	400	"Fault"	"Transformer coupling / series connection circuits not detected."	
IO board	401	"Fault"	"Remote inhibit was issued from remote interface."	
IO board	393	"Internal fault"	"Global fault detected."	
IO board	394	"Internal fault"	"Internal board fault."	
IO board	395	"Internal fault"	"Invalid node ID. Run unit discovery to recover."	
IO board	396	"Internal fault"	"Incorrect DSP type detected. Cycle-power to re-try."	
IO board	397	"Internal fault"	"Invalid constants loaded from EEPROM."	
IO board	398	"Internal fault"	"Controller is not in operational node."	
IO board	454	"Internal fault"	"Controller is not in operational node."	
IO board	455	"Internal fault"	"Missing controller node."	
IO board	456	"Internal fault"	"Cannot read fault information."	

Table 12-1: Warnings and Error Messages Listing

13 Service and Maintenance

13.1 Warnings



WARNING

THIS EQUIPMENT CONTAINS HIGH ENERGY, LOW IMPEDANCE CIRCUITS! LETHAL POTENTIALS ARE CONTAINED WITHIN THIS UNIT.

CARE MUST BE EXERCISED WHEN SERVICING THIS EQUIPMENT IN ORDER TO PREVENT SERIOUS SERVICE PERSONNEL INJURY OR EQUIPMENT DAMAGE.

OBSERVE THE FOLLOWING WHEN SERVICE OR MAINTENANCE ARE REQUIRED:

- 1. REMOVE ALL JEWELRY FROM ARMS AND NECK WHEN SERVICING THIS EQUIPMENT. THIS PREVENTS THE POSSIBILITY OF SHORTING THROUGH THE JEWELRY AND CAUSING BURNS TO SERVICE PERSONNEL.**
- 2. WEAR SAFETY GLASSES WHEN SERVICING THIS EQUIPMENT TO PREVENT EYE INJURY DUE TO FLYING PARTICLES CAUSED BY ACCIDENTAL SHORT CIRCUIT CONDITIONS.**
- 3. DO NOT REMOVE ANY PANEL OR COVER WITHOUT FIRST REMOVING THE INPUT SERVICE BY OPENING ALL CIRCUIT BREAKERS.**
- 4. DO NOT REMOVE ANY PANEL OR COVER WITHOUT FIRST WAITING 20 MINUTES FOR ALL INTERNAL CHARGES TO DISSIPATE TO A SAFE LEVEL.**
- 5. SERVICE OTHER THAN EXTERNAL CLEANING SHOULD BE REFERRED TO PERSONNEL AUTHORIZED BY THE FACTORY TO SERVICE THIS EQUIPMENT.**



WARNING

THIS EQUIPMENT CONTAINS HIGH ENERGY, LOW IMPEDANCE CIRCUITS! LETHAL POTENTIALS ARE CONTAINED WITHIN THIS UNIT.

CARE MUST BE EXERCISED WHEN SERVICING THIS EQUIPMENT IN ORDER TO PREVENT SERIOUS SERVICE PERSONNEL INJURY OR EQUIPMENT DAMAGE.

OBSERVE THE FOLLOWING WHEN SERVICE OR MAINTENANCE ARE REQUIRED:

- 1. REMOVE ALL JEWELRY FROM ARMS AND NECK WHEN SERVICING THIS EQUIPMENT. THIS PREVENTS THE POSSIBILITY OF SHORTING THROUGH THE JEWELRY AND CAUSING BURNS TO SERVICE PERSONNEL.**
- 2. WEAR SAFETY GLASSES WHEN SERVICING THIS EQUIPMENT TO PREVENT EYE INJURY DUE TO FLYING PARTICLES CAUSED BY ACCIDENTAL SHORT CIRCUIT CONDITIONS.**
- 3. DO NOT REMOVE ANY PANEL OR COVER WITHOUT FIRST REMOVING THE INPUT SERVICE BY OPENING ALL CIRCUIT BREAKERS.**
- 4. DO NOT REMOVE ANY PANEL OR COVER WITHOUT FIRST WAITING 20 MINUTES FOR ALL INTERNAL CHARGES TO DISSIPATE TO A SAFE LEVEL.**
- 5. SERVICE OTHER THAN EXTERNAL CLEANING SHOULD BE REFERRED TO PERSONNEL AUTHORIZED BY THE FACTORY TO SERVICE THIS EQUIPMENT.**

13.2 Authorized Service Centers

There are **NO** end-user serviceable parts in this product. In case of a problem or malfunction, **DO NOT ATTEMPT TO REPAIR!** Instead, contact one of Pacific Power Source's authorized service centers or your local Pacific Power Source distributor. For a list of authorized service centers, refer to section 1, "Contact Information".

14 ModBus TCP Server / Slave Interface

14.1 TCP ModBus TCP Interface

The ModBus TCP Server/Slave Interface provides a means to communicate with industrial bus protocols. This is a register based interface so no SCPI programming commands apply. Instead of sending commands, the user can write to specific register addresses to change various settings and read from other registers to option readings such as measurements or settings.

Gateway devices are available front third parties to connect to other bus protocols.

<https://www.anybus.com/products/gateway-index?Network-Interface-1=Modbus-TCP-Client/Master>

These gateways perform an intelligent protocol translation that allows devices and control systems using different protocols to communicate with each other seamlessly.

To use this interface, the user needs to reference the register addresses provided in the next section.

14.2 Modbus TCP Register Tables

The following tables apply to ADF, AFX, AZX, LMX and LSX Series power sources models. Some functions may not be supported on specific model series depending on supported modes of operation and feature sets.

Note: The information contained in the table below is available for download in MS Excel file [modbustcp-registers.xlsx](#) at the following link under 'documentation':

https://github.com/PPST-Inc/ModbusTCP_Examples

Modbus App

	Modbus address (dec)	Modbus address (hex)	Read coils	Read holding registers	Read input registers (0x06)	Write single coil (0x05)	Write single register (0x06)	Write multiple registers (0x10)	Description	Access	Data type	Data length in bytes	Number of registers	Data	Example
Modbus Interface	0	0000													
	1	0001			x				Modbus Ver	R	uint(16)	2	1		
	2	0002			x				Modbus Info	R	uint(16)	2	1		
Measurements	1000	03E8			x				Frequency	R	float	4	2	FP IEEE754	60
	1002	03EA			x				Output A frequency	R	float	4	2	FP IEEE754	
	1004	03EC			x				Output B frequency	R	float	4	2	FP IEEE754	
	1006	03EE			x				Output C frequency	R	float	4	2	FP IEEE754	
	1008	03F0			x				Voltage line to line ACDC	R	float	4	2	FP IEEE754	

Modbus App

Modbus address (dec)	Modbus address (hex)	Read coils	Read holding registers	Read input registers (0x06)	Write single coil (0x05)	Write single register (0x06)	Write multiple registers (0x10)	Description	Access	Data type	Data length in bytes	Number of registers	Data	Example
1010	03F2			x				Output A voltage line to line ACDC	R	float	4	2	FP IEEEE754	
1012	03F4			x				Output B voltage line to line ACDC	R	float	4	2	FP IEEEE754	
1014	03F6			x				Output C voltage line to line ACDC	R	float	4	2	FP IEEEE754	
1016	03F8			x				Voltage line to line AC	R	float	4	2	FP IEEEE754	
1018	03FA			x				Output A voltage line to line AC	R	float	4	2	FP IEEEE754	
1020	03FC			x				Output B voltage line to line AC	R	float	4	2	FP IEEEE754	
1022	03FE			x				Output C voltage line to line AC	R	float	4	2	FP IEEEE754	
1024	0400			x				Voltage line to line DC	R	float	4	2	FP IEEEE754	
1026	0402			x				Output A voltage line to line DC	R	float	4	2	FP IEEEE754	
1028	0404			x				Output B voltage line to line DC	R	float	4	2	FP IEEEE754	
1030	0406			x				Output C voltage line to line DC	R	float	4	2	FP IEEEE754	
1032	0408			x				Voltage ACDC	R	float	4	2	FP IEEEE754	
1034	040A			x				Output A voltage ACDC	R	float	4	2	FP IEEEE754	
1036	040C			x				Output B voltage ACDC	R	float	4	2	FP IEEEE754	
1038	040E			x				Output C voltage ACDC	R	float	4	2	FP IEEEE754	
1040	0410			x				Voltage AC	R	float	4	2	FP IEEEE754	
1042	0412			x				Output A voltage AC	R	float	4	2	FP IEEEE754	
1044	0414			x				Output B voltage AC	R	float	4	2	FP IEEEE754	
1046	0416			x				Output C voltage AC	R	float	4	2	FP IEEEE754	

Modbus App

Modbus address (dec)	Modbus address (hex)	Read coils	Read holding registers	Read input registers (0x06)	Write single coil (0x05)	Write single register (0x06)	Write multiple registers (0x10)	Description	Access	Data type	Data length in bytes	Number of registers	Data	Example
1048	0418			x				Voltage DC	R	float	4	2	FP IEEE754	
1050	041A			x				Output A voltage DC	R	float	4	2	FP IEEE754	
1052	041C			x				Output B voltage DC	R	float	4	2	FP IEEE754	
1054	041E			x				Output C voltage DC	R	float	4	2	FP IEEE754	
1056	0420			x				Current ACDC	R	float	4	2	FP IEEE754	
1058	0422			x				Output A current ACDC	R	float	4	2	FP IEEE754	
1060	0424			x				Output B current ACDC	R	float	4	2	FP IEEE754	
1062	0426			x				Output C current ACDC	R	float	4	2	FP IEEE754	
1064	0428			x				Current DC	R	float	4	2	FP IEEE754	
1066	042A			x				Output A current DC	R	float	4	2	FP IEEE754	
1068	042C			x				Output B current DC	R	float	4	2	FP IEEE754	
1070	042E			x				Output C current DC	R	float	4	2	FP IEEE754	
1072	0430			x				Active power	R	float	4	2	FP IEEE754	
1074	0432			x				Output A active power	R	float	4	2	FP IEEE754	
1076	0434			x				Output B active power	R	float	4	2	FP IEEE754	
1078	0436			x				Output C active power	R	float	4	2	FP IEEE754	
1080	0438			x				Apparent power	R	float	4	2	FP IEEE754	
1082	043A			x				Output A apparent power	R	float	4	2	FP IEEE754	
1084	043C			x				Output B apparent power	R	float	4	2	FP IEEE754	
1086	043E			x				Output C apparent power	R	float	4	2	FP IEEE754	
1088	0440			x				Peak current	R	float	4	2	FP IEEE754	
1090	0442			x				Output A peak current	R	float	4	2	FP IEEE754	
1092	0444			x				Output B peak current	R	float	4	2	FP IEEE754	

Modbus App

Modbus address (dec)	Modbus address (hex)	Read coils	Read holding registers	Read input registers (0x06)	Write single coil (0x05)	Write single register (0x06)	Write multiple registers (0x10)	Description	Access	Data type	Data length in bytes	Number of registers	Data	Example
1094	0446			x				Output C peak current	R	float	4	2	FP IEEE754	
1096	0448			x				Power factor	R	float	4	2	FP IEEE754	
1098	044A			x				Output A power factor	R	float	4	2	FP IEEE754	
1100	044C			x				Output B power factor	R	float	4	2	FP IEEE754	
1102	044E			x				Output C power factor	R	float	4	2	FP IEEE754	
1104	0450			x				Crest factor	R	float	4	2	FP IEEE754	
1106	0452			x				Output A crest factor	R	float	4	2	FP IEEE754	
1108	0454			x				Output B crest factor	R	float	4	2	FP IEEE754	
1110	0456			x				Output C crest factor	R	float	4	2	FP IEEE754	
1112	0458			x				Peak current recorded	R	float	4	2	FP IEEE754	
1114	045A			x				Output A peak current recorded	R	float	4	2	FP IEEE754	
1116	045C			x				Output B peak current recorded	R	float	4	2	FP IEEE754	
1118	045E			x				Output C peak current recorded	R	float	4	2	FP IEEE754	
1120	0460			x				Voltage thd	R	float	4	2	FP IEEE754	
1122	0462			x				Output A voltage thd	R	float	4	2	FP IEEE754	
1124	0464			x				Output B voltage thd	R	float	4	2	FP IEEE754	
1126	0466			x				Output C voltage thd	R	float	4	2	FP IEEE754	
1128	0468			x				Current thd	R	float	4	2	FP IEEE754	
1130	046A			x				Output A current thd	R	float	4	2	FP IEEE754	
1132	046C			x				Output B current thd	R	float	4	2	FP IEEE754	
1134	046E			x				Output C current thd	R	float	4	2	FP IEEE754	
1136	0470			x				Power factor angle	R	float	4	2	FP IEEE754	

Modbus App

Modbus address (dec)	Modbus address (hex)	Read coils	Read holding registers	Read input registers (0x06)	Write single coil (0x05)	Write single register (0x06)	Write multiple registers (0x10)	Description	Access	Data type	Data length in bytes	Number of registers	Data	Example
1138	0472			x				Output A power factor angle	R	float	4	2	FP IEEE754	
1140	0474			x				Output B power factor angle	R	float	4	2	FP IEEE754	
1142	0476			x				Output C power factor angle	R	float	4	2	FP IEEE754	
1144	0478			x				Displacement factor	R	float	4	2	FP IEEE754	
1146	047A			x				Output A displacement factor	R	float	4	2	FP IEEE754	
1148	047C			x				Output B displacement factor	R	float	4	2	FP IEEE754	
1150	047E			x				Output C displacement factor	R	float	4	2	FP IEEE754	
1152	0480			x				Distortion factor	R	float	4	2	FP IEEE754	
1154	0482			x				Output A distortion factor	R	float	4	2	FP IEEE754	
1156	0484			x				Output B distortion factor	R	float	4	2	FP IEEE754	
1158	0486			x				Output C distortion factor	R	float	4	2	FP IEEE754	
1160	0488			x				Kilowatt hour	R	float	4	2	FP IEEE754	
1162	048A			x				Output A kilowatt hour	R	float	4	2	FP IEEE754	
1164	048C			x				Output B kilowatt hour	R	float	4	2	FP IEEE754	
1166	048E			x				Output C kilowatt hour	R	float	4	2	FP IEEE754	
1168	0490			x				Kilowatt hour elapsed time	R	float	4	2	FP IEEE754	
1170	0492			x				Output A kilowatt hour elapsed time	R	float	4	2	FP IEEE754	
1172	0494			x				Output B kilowatt hour elapsed time	R	float	4	2	FP IEEE754	

Modbus App

Modbus address (dec)	Modbus address (hex)	Read coils	Read holding registers	Read input registers (0x06)	Write single coil (0x05)	Write single register (0x06)	Write multiple registers (0x10)	Description	Access	Data type	Data length in bytes	Number of registers	Data	Example
1174	0496			x				Output C kilowatt hour elapsed time	R	float	4	2	FP IEEE754	
2800	0AF0	x			x			Reset KWH	RW	bool			Coils : Kreset	ON=reset , self clear
2801	0AF1	x			x			Enable KWH	RW	bool			Coils : Kwhenable	ON=enable, OFF=disable

Setpoints	Modbus address (dec)	Modbus address (hex)	Read coils	Read holding registers	Read input registers (0x06)	Write single coil (0x05)	Write single register (0x06)	Write multiple registers (0x10)	Description	Access	Data type	Data length in bytes	Number of registers	Data	Example
Program	3000	0BB8							Program frequency	RW	float	4	2	FP IEEE754	
	3002	0BBA							Program frequency A	RW	float	4	2	FP IEEE754	
	3004	0BBC							Program frequency B	RW	float	4	2	FP IEEE754	
	3006	0BBE							Program frequency C	RW	float	4	2	FP IEEE754	
	3008	0BC0							Program voltage AC	RW	float	4	2	FP IEEE754	Value=VALUE if all set, Value=0 if else
	3010	0BC2							Program voltage AC output A	RW	float	4	2	FP IEEE754	
	3012	0BC4							Program voltage AC output B	RW	float	4	2	FP IEEE754	
	3014	0BC6							Program voltage AC output C	RW	float	4	2	FP IEEE754	
	3016	0BC8							Program voltage DC	RW	float	4	2	FP IEEE754	Value=VALUE if all set, Value=0 if else
	3018	0BCA							Program voltage DC output A	RW	float	4	2	FP IEEE754	
	3020	0BCC							Program voltage DC output B	RW	float	4	2	FP IEEE754	

Modbus App

Modbus address (dec)	Modbus address (hex)	Read coils	Read holding registers	Read input registers (0x06)	Write single coil (0x05)	Write single register (0x06)	Write multiple registers (0x10)	Description	Access	Data type	Data length in bytes	Number of registers	Data	Example
3022	0BCE							Program voltage DC output C	RW	float	4	2	FP IEEE754	
3024	0BD0							Power limit	RW	float	4	2	FP IEEE754	Value=V ALUE if all set, Value=0 if else
3026	0BD2							Power limit output A	RW	float	4	2	FP IEEE754	
3028	0BD4							Power limit output B	RW	float	4	2	FP IEEE754	
3030	0BD6							Power limit output C	RW	float	4	2	FP IEEE754	
3032	0BD8							Current limit ABC	RW	float	4	2	FP IEEE754	Value=V ALUE if all set, Value=0 if else
3034	0BDA							Current limit output A	RW	float	4	2	FP IEEE754	
3036	0BDC							Current limit output B	RW	float	4	2	FP IEEE754	
3038	0BDE							Current limit output C	RW	float	4	2	FP IEEE754	
3040	0BE0							KVA Limit	RW	float	4	2	FP IEEE754	Value=V ALUE if all set, Value=0 if else
3042	0BE2							KVA Limit output A	RW	float	4	2	FP IEEE754	
3044	0BE4							KVA Limit output B	RW	float	4	2	FP IEEE754	
3046	0BE6							KVA Limit output C	RW	float	4	2	FP IEEE754	
3048	0BE8							Phase offset output B	RW	float	4	2	FP IEEE754	
3050	0BEA							Phase offset output C	RW	float	4	2	FP IEEE754	
4000	0FA0	x			x			Enable output	RW	bool			Coils: Output	ON=enab le, OFF=disa ble
4001	0FA1	x			x			Enable output A	RW	bool			Coils: Output	ON=enab le,

Modbus App

Modbus address (dec)	Modbus address (hex)	Read coils	Read holding registers	Read input registers (0x06)	Write single coil (0x05)	Write single register (0x06)	Write multiple registers (0x10)	Description	Access	Data type	Data length in bytes	Number of registers	Data	Example
														OFF=disable
4002	0FA2	x			x			Enable output B	RW	bool			Coils: Output	ON=enable, OFF=disable
4003	0FA3	x			x			Enable output C	RW	bool			Coils: Output	ON=enable, OFF=disable

5000	1388	x			x			RMS Current protection	RW	bool				
5001	1389	x			x			Output A RMS Current protection	RW	bool				
5002	138A	x			x			Output B RMS Current protection	RW	bool				
5003	138B	x			x			Output C RMS Current protection	RW	bool				
5004	138C	x			x			RMS Power protection	RW	bool				
5005	138D	x			x			Output A RMS Power protection	RW	bool				
5006	138E	x			x			Output B RMS Power protection	RW	bool				
5007	138F	x			x			Output C RMS Power protection	RW	bool				
5008	1390	x			x			Peak current protection	RW	bool				
5009	1391	x			x			Output A Peak current protection	RW	bool				
5010	1392	x			x			Output B Peak current protection	RW	bool				
5011	1393	x			x			Output C Peak current protection	RW	bool				

Modbus App

Modbus address (dec)	Modbus address (hex)	Read coils	Read holding registers	Read input registers (0x06)	Write single coil (0x05)	Write single register (0x06)	Write multiple registers (0x10)	Description	Access	Data type	Data length in bytes	Number of registers	Data	Example
5012	1394	x			x			Peak voltage protection	RW	bool				
5013	1395	x			x			Output A Peak voltage protection	RW	bool				
5014	1396	x			x			Output B Peak voltage protection	RW	bool				
5015	1397	x			x			Output C Peak voltage protection	RW	bool				
5024	13A0							Current level	RW	float	4	2	FP IEEE754	
5026	13A2							Output A Current level	RW	float	4	2	FP IEEE754	
5028	13A4							Output B Current level	RW	float	4	2	FP IEEE754	
5030	13A6							Output C Current level	RW	float	4	2	FP IEEE754	
5032	13A8							Power level	RW	float	4	2	FP IEEE754	
5034	13AA							Output A Power level	RW	float	4	2	FP IEEE754	
5036	13AC							Output B Power level	RW	float	4	2	FP IEEE754	
5038	13AE							Output C Power level	RW	float	4	2	FP IEEE754	
5040	13B0							KVA Level	RW	float	4	2	FP IEEE754	
5042	13B2							Output A KVA Level	RW	float	4	2	FP IEEE754	
5044	13B4							Output B KVA Level	RW	float	4	2	FP IEEE754	
5046	13B6							Output C KVA Level	RW	float	4	2	FP IEEE754	
5048	13B8							Trip time	RW	float	4	2	FP IEEE754	minimum step of 0.1 seconds
5050	13BA							Output A Trip time	RW	float	4	2	FP IEEE754	
5052	13BC							Output B Trip time	RW	float	4	2	FP IEEE754	
5054	13BE							Output C Trip time	RW	float	4	2	FP IEEE754	
5056	13C0							Peak current limit	RW	float	4	2	FP IEEE754	

Modbus App

Modbus address (dec)	Modbus address (hex)	Read coils	Read holding registers	Read input registers (0x06)	Write single coil (0x05)	Write single register (0x06)	Write multiple registers (0x10)	Description	Access	Data type	Data length in bytes	Number of registers	Data	Example
5058	13C2							Output A Peak current limit	RW	float	4	2	FP IEEE754	
5060	13C4							Output B Peak current limit	RW	float	4	2	FP IEEE754	
5062	13C6							Output C Peak current limit	RW	float	4	2	FP IEEE754	
5064	13C8							Peak current protection level	RW	float	4	2	FP IEEE754	
5066	13CA							Output A Peak current protection level	RW	float	4	2	FP IEEE754	
5068	13CC							Output B Peak current protection level	RW	float	4	2	FP IEEE754	
5070	13CE							Output C Peak current protection level	RW	float	4	2	FP IEEE754	
5072	13D0							Peak voltage protection margin	RW	float	4	2	FP IEEE754	
5074	13D2							Output A Peak voltage protection margin	RW	float	4	2	FP IEEE754	
5076	13D4							Output B Peak voltage protection margin	RW	float	4	2	FP IEEE754	
5078	13D6							Output C Peak voltage protection margin	RW	float	4	2	FP IEEE754	
5080	13D8							Peak voltage protection level	RW	float	4	2	FP IEEE754	
5082	13DA							Output A Peak voltage protection level	RW	float	4	2	FP IEEE754	

Modbus App

Modbus address (dec)	Modbus address (hex)	Read coils	Read holding registers	Read input registers (0x06)	Write single coil (0x05)	Write single register (0x06)	Write multiple registers (0x10)	Description	Access	Data type	Data length in bytes	Number of registers	Data	Example
5084	13DC							Output B Peak voltage protection level	RW	float	4	2	FP IEEE754	
5086	13DE							Output C Peak voltage protection level	RW	float	4	2	FP IEEE754	
5088	13E0							Peak voltage protection mode	RW	uint(16)	2	1	unsgnd int 16b	0=MARGIN, 1=LEVEL, 2=MARGIN &LEVEL
5090	13E2							Output A Peak voltage protection mode	RW	uint(16)	2	1	unsgnd int 16b	
5092	13E4							Output B Peak voltage protection mode	RW	uint(16)	2	1	unsgnd int 16b	
5094	13E6							Output C Peak voltage protection mode	RW	uint(16)	2	1	unsgnd int 16b	

Configuration	6000	1770						Ramp time	RW	float	4	2	FP IEEE754	0.222 Seconds
Slew	6002	1772						Output A Ramp time	RW	float	4	2	FP IEEE754	
	6004	1774						Output B Ramp time	RW	float	4	2	FP IEEE754	
	6006	1776						Output C Ramp time	RW	float	4	2	FP IEEE754	
	6008	1778						Voltage AC	RW	float	4	2	FP IEEE754	
	6010	177A						Output A Voltage AC	RW	float	4	2	FP IEEE754	
	6012	177C						Output B Voltage AC	RW	float	4	2	FP IEEE754	
	6014	177E						Output C Voltage AC	RW	float	4	2	FP IEEE754	
	6016	1780						Frequency	RW	float	4	2	FP IEEE754	
	6018	1782						Output A Frequency	RW	float	4	2	FP IEEE754	

Modbus App

Modbus address (dec)	Modbus address (hex)	Read coils	Read holding registers	Read input registers (0x06)	Write single coil (0x05)	Write single register (0x06)	Write multiple registers (0x10)	Description	Access	Data type	Data length in bytes	Number of registers	Data	Example
6020	1784							Output B Frequency	RW	float	4	2	FP IEEE754	
6022	1786							Output C Frequency	RW	float	4	2	FP IEEE754	
6024	1788							Voltage DC	RW	float	4	2	FP IEEE754	
6026	178A							Output A Voltage DC	RW	float	4	2	FP IEEE754	
6028	178C							Output B Voltage DC	RW	float	4	2	FP IEEE754	
6030	178E							Output C Voltage DC	RW	float	4	2	FP IEEE754	
6032	1790							Phase	RW	float	4	2	FP IEEE754	
6034	1792							Output A Phase	RW	float	4	2	FP IEEE754	
6036	1794							Output B Phase	RW	float	4	2	FP IEEE754	
6038	1796							Output C Phase	RW	float	4	2	FP IEEE754	
6040	1798				x			Slew rate control	RW	bool				
6041	1799				x			Output A Slew rate control	RW	bool				
6042	179A				x			Output B Slew rate control	RW	bool				
6043	179B				x			Output C Slew rate control	RW	bool				

Configuration	8000	1F40						Configuration form	RW	uint(16)	2	1	unsgnd int 16b	1=SINGLE, 2=SPLIT, 3=THREE
Unit	8001	1F41						Configuration voltage range	RW	uint(16)	2	1	unsgnd int 16b	0=LOW, 1=HIGH
Settings	8002	1F42						Configuration mode	RW	uint(16)	2	1	unsgnd int 16b	0=AC, 1=DC, 2=AC-DC
	8003	1F43						Phase rotation	RW	uint(16)	2	1	unsgnd int 16b	0=NEGATIVE, 1=POSITIVE
	8004	1F44						Output impedance mode	RW	uint(16)	2	1	unsgnd int 16b	0=REAL TIME, 1=RMS

Modbus App

Modbus address (dec)	Modbus address (hex)	Read coils	Read holding registers	Read input registers (0x06)	Write single coil (0x05)	Write single register (0x06)	Write multiple registers (0x10)	Description	Access	Data type	Data length in bytes	Number of registers	Data	Example
8005	1F45							Output A impedance mode	RW	uint(16)	2	1	unsngnd int 16b	
8006	1F46							Output B impedance mode	RW	uint(16)	2	1	unsngnd int 16b	
8007	1F47							Output C impedance mode	RW	uint(16)	2	1	unsngnd int 16b	
8016	1F50							Update phase	RW	float	4	2	FP IEEE754	
8018	1F52							Output A update phase	RW	float	4	2	FP IEEE754	
8020	1F54							Output B update phase	RW	float	4	2	FP IEEE754	
8022	1F56							Output C update phase	RW	float	4	2	FP IEEE754	
8024	1F58							Output phase disable	RW	float	4	2	FP IEEE754	
8026	1F5A							Output A phase disable	RW	float	4	2	FP IEEE754	
8028	1F5C							Output B phase disable	RW	float	4	2	FP IEEE754	
8030	1F5E							Output C phase disable	RW	float	4	2	FP IEEE754	
8032	1F60							Max CSC gain	RW	float	4	2	FP IEEE754	
8034	1F62							Output A max CSC gain	RW	float	4	2	FP IEEE754	
8036	1F64							Output B max CSC gain	RW	float	4	2	FP IEEE754	
8038	1F66							Output C max CSC gain	RW	float	4	2	FP IEEE754	
8048	1F70	x			x			Continuous self calibration	RW	bool				
8049	1F71	x			x			Output A continuous self calibration	RW	bool				
8050	1F72	x			x			Output B continuous self calibration	RW	bool				
8051	1F73	x			x			Output C continuous	RW	bool				

Modbus App

Modbus address (dec)	Modbus address (hex)	Read coils	Read holding registers	Read input registers (0x06)	Write single coil (0x05)	Write single register (0x06)	Write multiple registers (0x10)	Description	Access	Data type	Data length in bytes	Number of registers	Data	Example
								self calibration						
8052	1F74	x			x			Fault on saturation	RW	bool				
8053	1F75	x			x			Output A fault on saturation	RW	bool				
8054	1F76	x			x			Output B fault on saturation	RW	bool				
8055	1F77	x			x			Output C fault on saturation	RW	bool				

6400	FA00							SCPI Write/query	RW	char	246	123	ASCII	MEASure : VOLTage : DC:NC#?
6426	FB00							SCPI Command last answer			1024	512	ASCII	0.000,0 .000 0.000,0 .000
6479	FD01	x			x			SCPI Char 16 endianess	RW	bool			Coils : Endianess	OFF= little, ON= Inverted
6470	FD02	x			x			SCPI Response next page	RW	bool			Coils : Next Page	ON=next, self clear

14.3 ModBus Control Example using Python

For those not familiar with using the ModBus TCP protocols, the example code shown here using Python may be of assistance in getting started.

Note: The example code named “modbustcp-example-1.py” referenced below is available for download at the following link in the ‘python’ directory:

https://github.com/PPST-Inc/ModbusTCP_Examples

This example code performs the following tasks in the order shown below.

```
> python.exe modbustcp-example-1.py
Enter the IP address of the unit: 192.168.107.183
Connecting
Setting voltage AC to 0 Vrms
Setting frequency to 50 Hz
Turning output on...
Setting voltage AC to 30 Vrms
Reading RMS voltage measurement
Voltage RMS measurement: 29.93 Vrms
Reading RMS current measurement
Current RMS measurement: 2.74 Arms
Turning output off
Disconnecting
Done
```

The dependencies and requirements to run the sample code are shown in the program comments and are:

```
# PPST ModbusTCP python example 1
# Version: 1.0.0
# Date: 11/07/2022
# Dependences:
# - pip install pymodbus
# - pip install pyModbusTCP
# Last tested with:
# - Python 3.10.5
# - pymodbus 3.0.2
# - pyModbusTCP 0.2.0
```

More advanced samples can be found using the link referenced above.

15 CE MARK Declaration of Conformity

The Manufacturer hereby declares that the products:

Product Name: AFX Series & ADF Series® Power Sources, All Models in Series

Conforms to the following standards or other normative documents:

RoHS (DIRECTIVE 2011/65/EU)

Standard applied EN IEC 63000:2018

SAFETY (DIRECTIVE 2014/35/EU):

Standard applied EN 61010-1: 2010; ED3/A1:2019

EMC (DIRECTIVE 2014/30/EU):

Standard applied EN 61326-1: 2013

Reference Standards:

ELECTROMAGNETIC EMISSIONS:

Radiated Emissions CISPR 11/22, CLASS A LIMITS
Conducted Emissions CISPR 11/22, CLASS A LIMITS

ELECTROMAGNETIC IMMUNITY:

RF Electromagnetic Field IEC 61000-4-3:2006+A1:2007+A2:2010
80 – 1000 MHz, 10 V/m
1 Khz sinewave (80% AM) 1.4 – 2 GHz, 3 V/m
2.0 – 2.7 GHz, 1 V/m

Conducted RF Immunity IEC 61000-4-6:2013
Conducted RF Immunity 0.15 – 80 MHz @ 3 Vrms

Electrostatic Discharge IEC 61000-4-2:2008
± 4 kV contact discharge
± 8 kV air discharge

Electrical Fast Transient/Burst IEC 61000-4-4:2004+A1:2010
AC or DC power ports, ± 2.0 kV
Signal and I/O ports, ± 1.0 kV

Surge IEC 61000-4-5:2006
AC or DC power ports, ± 2.0 kV Line to ground and ± 1.0 kV Line to Line

Power Frequency Magnetic Field IEC 61000-4-8:2009
30 A/m

Supplemental Information:

When and Where Issued September 28, 2022
Irvine, California, USA

Authorized Signatory 
Mitchel Orr,
Quality Manager, acting
Pacific Power Source

Responsible Person Mitchel Orr,
Pacific Power Source, Inc.
2802 Kelvin Ave, Suite 100
Irvine CA, 92614

Mark of Compliance



Index

A

AC input.....	42
AC Input	33, 46
AC terminal block.....	45
accessories	
included	22
Accessories.....	22
air filter	51
Airflow.....	48

B

Browser	302
Remote Interface.....	337

C

Cabinet	
Options	74
Calibration	345
Commands.....	181
CE MARK.....	392
Circuit Breaker	47
CONFIGURATION	
Screens	108
Configuration Settings.....	110
Connections	148
Console	
SCPI	138
Contact.....	12, 63, 376
Contents.....	3
CSC Configuration.....	117

D

date formats	266
Date formats.....	266
decimal separator	266
Decimal separator.....	266

E

E Version.....	26
Energy Savings Modes.....	85
equipment weight.....	40
Error and Event queue.....	122
Error Messages.....	352
Ethernet.....	75
Access Control	304
Export Version.....	26, 39
External Voltage Sense	150

F

Fault Queue	122
FE Version.....	39
Features	20

File Manager.....	141
Filter	
Air Intake	51
Firmware Update.....	146
front panel operation.....	82

G

Grounding	
Cabinet Systems	70

I

Installation.....	13, 40, 300
Interface	
Ethernet	75
Ethernet Browser.....	302
GPIB Settings	133
I/O Settings	133
LAN.....	75
Monitor	84
Remote Inhibit Settings	134
RS232 Settings.....	131
Screens.....	123
USB Settings	132

K

Keyboard	83
Touchscreen.....	126
KIT 48	

L

LAN	
Access Control.....	304
Browser Interface	302
Configuration	302
Setup.....	129
LAN Configuration	302
LAN.....	75
LCD Image	
capture to image file	83
Logging measurement data	106

M

Maintenance	
Air Filter Cleaning	50
Managing	
Files141	
Manual	312
Measurement Command	
Resolution Setting	192
Measurements	
Datalogger	105
MEASUREMENTS	
Logging	147
Plotting	104
Screen.....	101

Soft Keys	102, 105	Screen capture	
Memory		LCD Image.....	340
SD Card.....	84	SD Card	84
USB84		Sense Terminals	150
Memory Management	140	Service	375
Menus.....	86	Shuttle	83
ModBus		Size 149	
TCP377		Slew Rates.....	114
O		Specifications.....	24
optional output transformer.....	110	Start Phase	110
Output		Stop Phase	110
Control Switch	74	SYSTEM	
Enable Button.....	83	Screens.....	120
Response Time.....	85	system bus.....	78
Output Enable	85	system interface	77
P		System Interface.....	177
Parallel Operation	77	T	
Phase Angle		T Option	110
Control	110	Terminals	148
phase rotation		Terminator Characters	179
positive or negative	112	Tools Required	
Phase rotation	90	Cabinets.....	64
Powering Up.....	63	Touchscreen Keyboard.....	126
Presets		Transformer	
Output Parameters.....	91	Option.....	244
PROGRAM		Turn on.....	63
Soft Keys	93	U	
PROGRAM & MEASUREMENTS		UNIT INFORMATION	136
Screen	87	unpacking	40
Program Data Entry.....	91	Update Phase.....	110
Program Memory	116	USB	
Programming	82, 178	Drivers.....	300
Conventions	178	USB.....	75
Terminators	179	User Limits.....	113
Protection	31	User Presets.....	118
R		V	
Rear Panel		Video Monitor	84
Connector Locations.....	74	Virtual Front Panel	
Recommended Wire Sizing.....	52	Browser.....	337
regional setting.....	266	voltage sense	
Regional setting	266	External.....	62
Remote Control.....	178	Internal	62
RS232		W	
Interface.....	131	Warranty	13
S		Weight.....	33
safety information.....	13	Wire Size.....	149
Safety Information.....	13	Wire Sizing	
Safety Notices	15	Recommended.....	52
SCIP Console	138		



Pacific Power Source

The Power of Expertise