

Operation Manual

AZX Series® – Rev 1.1.9

P/N 162050-10

AZX Series® Programmable Power Source



 **PACIFIC**® **PACIFIC POWER SOURCE**

PACIFIC POWER SOURCE
Worldwide Supplier of Precision Programmable Power

Copyright © 2024, Pacific Power Source, Inc. (PPS) • All Rights Reserved • No reproduction without written authorization from PPS.

GENERAL DISCLAIMER

Pacific Power Source, Inc. reserves the right to revise this documentation and to make changes in content from time to time without obligation on the part of Pacific Power Source, Inc. to provide notification of such revision or change. This publication may include technical or other inaccuracies or typographical errors. Furthermore, changes are periodically added to the information herein; these changes will be incorporated in new editions of the publication. Pacific Power Source, Inc. may make improvements and/or changes in the operation, features, functions and/or technical specifications described in this publication at any time.

Table of Contents

1	Contact Information	16
2	Safety & Warranty Information	17
2.1	Limited Warranty	17
2.2	Service and Spare Parts Limited Warranty	17
2.3	Safety Information.....	17
2.4	Safety Notices	19
3	Product Overview	24
3.1	General Description.....	24
3.2	Product Features	24
3.3	Available Options.....	25
3.3.1	Option B Description	25
3.3.2	Option C Description	25
3.3.3	Option D Description	25
3.3.4	Option H Description	26
3.3.5	Option L Description.....	26
3.3.6	Option W Description & Connection Considerations	26
3.3.7	Multi-unit Parallel Systems Option Support.....	28
3.4	Block Diagram	28
3.5	Controller Description	29
3.6	Measurement Read-back	29
3.7	Load Mode of Operation (Option L).....	29
3.7.1	Constant Current (CC) Mode	30
3.7.2	Constant Resistive (CR) Mode.....	31
3.7.3	Constant Power (CP) Mode.....	33
3.7.4	Circuit Emulation Mode	35
3.7.5	Inrush Current Simulation Mode.....	38
3.8	Accessories Included (Ship Kit)	39
3.9	Remote Control Interfaces.....	39
4	Technical Specifications	40
4.1	Single Cabinet Models.....	40
4.2	Multiple Cabinet Models	40
4.3	AC Output Mode	41
4.3.1	Programmable Output Impedance Ranges by Phase Mode.....	43
4.3.2	Programmable Impedance operation	43
4.3.3	AC Voltage and Current Output Charts	44
4.3.4	Output Capacitance.....	50
4.4	DC Output Mode	51
4.4.1	DC Voltage and Output Current Charts	52
4.5	Protection Modes.....	57
4.6	Metering	57
4.7	Other Measurements.....	58
4.8	Transients.....	58
4.9	AC Input	59
4.10	Dimensions & Weight	60
4.11	Environmental	61
4.12	Safety & Regulatory.....	61
4.13	Digital Interfaces.....	61
4.14	Auxiliary I/O (Digital & Analog I/O).....	62
4.15	Electronic Load Mode (Option L).....	64

4.15.1	Constant Current (CC) Mode	64
4.15.2	Constant Current (CR) Mode	64
4.15.3	Constant Power (CP) Mode.....	64
4.15.4	Circuit Emulation (CE) Mode.....	64
4.16	Hardware in the Loop Option H	65
4.16.1	Option H (HIL Real Time Interface).....	65
5	Unpacking and Installation	66
5.1	Inspection	66
5.2	Lifting and Carrying Instructions.....	66
5.3	Verify Correct AC Input Line Voltage.....	67
5.4	AC Input Connections.....	68
5.4.1	Checking Rated AC Input Voltage	69
5.4.2	Changing AC Input Voltage Settings	69
5.4.3	AC Input Voltage Monitoring Relay	70
5.4.4	AC Input Connections	71
5.4.5	Power On Procedure	73
5.4.6	Safety Circuits Status Monitor	74
5.5	Grounding Requirements	76
5.5.1	Chassis Ground Connection Required	76
5.5.2	Output Neutral Grounding.....	76
5.6	AC Input Circuit Breaker.....	77
5.7	Emergency Shutdown & Restart Procedure.....	78
5.8	Airflow	78
5.9	Sound Levels	79
5.10	Cleaning.....	80
5.11	Air Intake Filter Removal and Cleaning	80
5.11.1	Air Filter Removal	80
5.11.2	Filter Cleaning	81
5.11.3	Air Filter Installation.....	81
5.12	Liquids Warnings	81
5.13	Load Connections	82
5.13.1	Output Wiring and Recommended Wire Sizing.....	84
5.13.2	Three Phase Wye Load Output Connection.....	85
5.13.3	FORM4 and FORM5 Load Output Connections.....	87
5.13.4	Three Phase Delta Load Output Connection – Standard AZX	89
5.13.5	Three Phase Delta Load Output Connection – AZX with W Option.....	91
5.13.6	Load Mode Three Phase Load Connections & W Option.....	92
5.13.7	Single Phase Load Output Connection	94
5.13.8	DC Mode with Series Connections (AZX-W only)	95
5.13.9	External Voltage Sense Connections	96
5.13.10	FB1 and FB2 Connections.....	97
5.13.11	Powering Up	97
5.13.12	In Case of Malfunction	98
5.14	Parallel Cabinets System Installation.....	98
5.14.1	Load Connections on Parallel Systems	98
5.14.2	Parallel System Bus Connection.....	99
5.15	Interface Options.....	101
5.15.1	Rear Panel Interface Connector Locations.....	101
5.15.2	USB Device Interface	101
5.15.3	RS232 Serial Interface.....	101
5.15.4	GPIB Device Interface	102
5.15.5	LAN Interface	102
6	Front Panel Operation	103

6.1	Front Panel Layout	103
6.1.1	Keyboard Buttons	104
6.1.2	Shuttle Knob.....	105
6.1.3	PC Monitor Output	105
6.1.4	USB Host Ports.....	105
6.1.5	SD Card Memory Slot	105
6.2	OUTPUT ENABLE Button.....	106
6.3	Menu Keys	106
6.4	PROG – PROGRAM Screens	107
6.4.1	Power On Settings	108
6.4.2	PROGRAM Parameters – Voltage Source Mode	108
6.4.3	PROGRAM Parameters – Current Source Mode	110
6.4.4	PROGRAM Parameters – Load Mode Option	111
6.4.5	Phase Rotation / Phase Sequence	126
6.4.6	Direct Data Entry - Presets	127
6.4.7	Customizing Output Programming Preset Soft Key Values.....	128
6.4.8	Changing Shuttle Programming Resolution	128
6.4.9	Phase Mode Selection.....	129
6.4.10	PROGRAM Soft Keys.....	130
6.4.11	Available Waveforms	134
6.4.12	Waveform Smoothing Filter.....	136
6.4.13	AUTO RMS Function – Steady State – AC Source Mode	137
6.4.14	PROGRAM Harmonics.....	138
6.4.15	PROGRAM Interharmonics (Option C)	139
6.4.16	DEVIATION Setpoint Programming	140
6.5	MEAS – MEASUREMENTS Screens	143
6.5.1	Measurements Screen	143
6.5.2	Scope Measurements	144
6.5.3	Harmonic Measurements	145
6.5.4	Measurement Screen Soft Keys.....	146
6.5.5	Measurement Data Logging.....	148
6.5.6	Three Phase Measurement Screen Soft Keys	149
6.5.7	Individual Phase Measurement Screen Soft Keys.....	151
6.6	TRAN- TRANSIENTS Screens	152
6.6.1	LIST Mode	152
6.6.2	LIST Parameters	153
6.6.3	LIST Transient Edit Mode	156
6.6.4	LIST Transient Execution Modes.....	157
6.6.5	LIST Transient Entry Modes	159
6.6.6	Multiple User Waveforms in LIST Transients	160
6.6.7	STEP or RAMP Modes.....	161
6.6.8	STEP or RAMP Parameters.....	162
6.6.9	STEP or RAMP Transient Execution Modes.....	163
6.6.10	PULSE Mode.....	164
6.6.11	PULSE Parameters	165
6.6.12	PULSE Transient Execution Modes.....	166
6.6.13	AUTO RMS Function – Transients.....	167
6.6.14	INRUSH CURRENT Mode.....	167
6.6.15	INRUSH CURRENT Settings.....	168
6.6.16	INRUSH CURRENT Web Browser Control.....	170
6.6.17	INRUSH CURRENT Capture Examples.....	172
6.7	CONF – CONFIGURATION Screens	174
6.7.1	UNIT CONFIGURATION Screens.....	175
6.7.2	USER LIMITS SETTINGS Screen.....	179

6.7.3	RAMP TIME & SLEW RATE SETTINGS Screen	180
6.7.4	PROGRAM MEMORY Screen	182
6.7.5	CSC CONFIGURATION Screen	183
6.7.6	TRANSIENT SETTINGS Screen.....	184
6.7.7	OUTPUT IMPEDANCE Screen.....	185
6.7.8	USER PRESETS Screen.....	186
6.8	SYST – SYSTEM Screens	188
6.8.1	SYSTEM MENU 1.....	189
6.8.2	SYSTEM MENU 2.....	189
6.8.3	ERROR / EVENT QUEUE Screen	190
6.8.4	FAULT INFORMATION Screen.....	190
6.8.5	INTERFACE Screen	191
6.8.6	UNIT INFORMATION Screen	204
6.8.7	CONNECTED UNITS Screen	205
6.8.8	SCPI CONSOLE.....	206
6.8.9	SYSTEM SETTINGS Screen	207
6.8.10	MEMORY MANAGEMENT Screen	208
6.8.11	CALIBRATION MENU Screen.....	213
6.8.12	FIRMWARE UPDATE Screen.....	214
6.8.13	REMOTE SUPPORT Screen	215
7	Rear Panel, Connectors and Protection	216
7.1	OUTPUT Terminals	216
7.1.1	Output Power Connector Rating and Isolation.....	217
7.1.2	Wire Size.....	217
7.1.3	Connecting a UUT.....	217
7.2	External Voltage Sense Input Terminals	218
7.2.1	External Voltage Sense Connector Rating and Isolation	219
7.2.2	Load Connection without External Voltage Sense.....	219
7.2.3	Load Connection with External Voltage Sense.	219
7.3	Auxiliary I/O	220
7.3.1	Auxiliary I/O Functions	220
7.3.2	DB25 Connector AUX I/O Pin locations	221
7.3.3	Aux I/O Signal Table by pin number	222
7.3.4	Aux I/O Signal Table by Function	223
7.3.5	DB25 Connector REAL TIME I/O Pin locations – Option “H”	224
7.3.6	Dedicated Function Digital Inputs.....	225
7.3.7	Transient Trigger Input.....	226
7.3.8	External or Line Sync Input.....	226
7.3.9	Digital Output control signals.....	229
7.3.10	User Programmable Digital signals.....	232
7.3.11	Analog I/O Descriptions.....	234
7.3.12	12 DC Power Supply	235
7.3.13	RS232 Description.....	235
7.3.14	Front Panel Operation of AUX I/O Functions.....	236
8	Remote Control Programming.....	243
8.1	Overview	243
8.1.1	Programming Conventions and Notations.....	243
8.1.2	Command Terminators	244
8.2	Remote Control Command Descriptions by Subsystem	245
8.3	Calibration Commands.....	246
8.3.1	AZX Calibration Commands	246
8.3.2	UPC Specific commands.....	248
8.3.3	AUX I/O Interface Calibration Commands	248
8.4	Measurement Commands.....	249

8.4.1	Voltage Measurement Commands	249
8.4.2	Frequency Measurement Commands	253
8.4.3	Current Measurement Commands	253
8.4.4	Power Measurement Commands	255
8.4.5	KWh Measurement Commands	256
8.4.6	Other Measurement Commands	257
8.4.7	Measurement Data Logging Commands	258
8.4.8	Waveform Capture Commands.....	261
8.4.9	Harmonic Measurements Commands	263
8.4.10	Measurement Resolution Setting Commands.....	268
8.5	Output Control Commands	269
8.6	Program Commands	274
8.6.1	Program Control Commands	274
8.6.2	Execution Commands.....	287
8.6.3	Transient Segments Commands.....	288
8.6.4	Memory Management Commands.....	295
8.7	Voltage Source Commands.....	298
8.7.1	Source Configuration Programming Commands.....	298
8.7.2	Voltage Programming Commands	303
8.7.3	Real Time Voltage Slew Rate Programming Commands.....	316
8.7.4	Frequency Programming Commands.....	319
8.7.5	Current Limit Programming Commands	321
8.7.6	Phase Programming Commands	323
8.7.7	Waveform Programming Commands	325
8.7.8	Voltage Protection Programming Commands.....	333
8.7.9	Voltage Sense Protection Commands	338
8.7.10	Current Protection Programming Commands.....	340
8.7.11	Power Protection Programming Commands.....	344
8.7.12	Frequency Protection Programming Commands	349
8.7.13	Impedance Programming Commands	350
8.7.14	STEP Transient Commands	352
8.7.15	PULSE Transient Commands.....	372
8.7.16	Interharmonics Commands (IEC61000-4-13 Option C).....	384
8.7.17	Harmonics Generation Commands.....	391
8.8	Current Source Commands.....	396
8.8.1	Current Programming Commands	396
8.8.2	Current Slew Rate Programming Commands	399
8.8.3	Real Time Current Slew Rate Programming Commands.....	400
8.8.4	Current Transient Programming.....	402
8.8.5	Voltage Protection Programming Commands.....	402
8.8.6	Peak Current Protection Programming Commands.....	405
8.8.7	Peak Power Protection Programming Commands.....	407
8.8.8	User Limit Commands	408
8.8.9	Voltage and Frequency RMS Protection Commands	410
8.9	Active Load Commands	418
8.9.1	Load Mode Commands.....	418
8.9.2	Load Sync Commands	418
8.9.3	Load Waveform Commands	420
8.9.4	Load SOURCE Frequency Commands.....	421
8.9.5	Load Voltage Input Protection Commands	422
8.9.6	Load Phase Commands	422
8.9.7	Load Power & KVA Limit Commands	423
8.9.8	Load CC Mode Commands.....	425
8.9.9	Load CR Mode Commands.....	427
8.9.10	Load CP Mode Commands.....	441

8.9.11	Load Circuit Emulation Commands	454
8.9.12	Transient Inrush Current Mode Commands	460
8.9.13	High Impedance Mode Commands	485
8.10	Status Commands	487
8.11	System Commands	489
8.11.1	System Error Commands	489
8.11.2	System Information Commands	491
8.11.3	System Interface Commands	495
8.11.4	System Configuration Commands	499
8.11.5	System Operation Mode Commands	500
8.11.6	Parallel System Commands	501
8.11.7	System Sanitization Commands	502
8.11.8	Communication LAN Commands	502
8.11.9	Communication Serial Port Commands	507
8.11.10	Communication USB Commands	509
8.11.11	Communication GPIB Commands	511
8.11.12	Communication CAN / CAN-FD Commands	513
8.11.13	System Firmware Commands	514
8.11.14	System Remote Access Commands	515
8.11.15	System Regional Setting Commands	517
8.11.16	Miscellaneous System Commands	517
8.11.17	System Import / Export Commands	518
8.11.18	Miscellaneous Remote Restart Commands	519
8.12	Auxiliary I/O System Commands	520
8.12.1	System Analog & Digital IO Commands	520
8.12.2	SOURce:SYNChronize Commands	533
8.12.3	PROGram:TRANSient Triggers Commands	536
8.12.4	AUX I/O Calibration Commands	538
8.13	Test Sequence Commands	542
8.14	IEEE488.2 Common Commands	545
8.15	Status and Events Registers	549
8.15.1	Status Byte Register (STB)	549
8.15.2	Status Event Register (ESR)	551
8.15.3	SCPI Status Registers	552
9	USB Driver Installation	554
9.1	Overview	554
9.2	Installation	554
10	LAN Interface Configuration	556
10.1	Overview	556
10.2	Web Browser Interface	556
10.3	Access Control	558
10.3.1	Browser Access Control	559
10.3.2	Front Panel Access Control	563
10.4	Web Browser Interface	564
10.5	Available Web Interface Menu Tree	564
10.6	Home Screen	565
10.6.1	SCPI Console Command Line Interface	565
10.6.2	Status Byte Display	566
10.6.3	Browser Status Bar	566
10.6.4	Operation Manual PDF	566
10.7	Source Control Screens	567
10.7.1	Program	568
10.7.2	Protections	576

10.7.3	Transients.....	577
10.7.4	Analog Programming.....	583
10.7.5	Interharmonic & Harmonic.....	584
10.7.6	Setpoint Deviation.....	585
10.7.7	Program Memory.....	588
10.7.8	Waveform.....	589
10.7.9	Waveform Editor.....	590
10.7.10	Test Sequence.....	595
10.7.11	SCPI Script.....	597
10.8	Measurement Screens.....	599
10.8.1	Monitor.....	600
10.8.2	Real-Time Plot.....	601
10.8.3	V/I Plot.....	602
10.8.4	Data Logger.....	603
10.8.5	Scope Functions.....	604
10.8.6	Harmonics Measurements.....	608
10.9	Configuration Screens.....	610
10.9.1	Unit Settings.....	611
10.9.2	User Limits & Presets.....	615
10.9.3	Ramp Time & Slew Rate.....	616
10.10	System Screens.....	617
10.10.1	Error/Event Queue.....	618
10.10.2	Fault List.....	619
10.10.3	Error/Event List.....	620
10.10.4	Interface Setup.....	621
10.10.5	Access Control.....	622
10.10.6	Digital & Analog IO's.....	623
10.10.7	Remote Interface (Virtual Front Panel).....	627
10.10.8	Unit Information.....	628
10.10.9	Connected Units.....	629
10.10.10	Memory Browser.....	630
10.10.11	Calibration.....	631
10.10.12	Remote Support.....	632
10.10.13	Import / Export.....	632
10.10.14	Firmware Update.....	633
10.10.15	Sanitize and Reboot.....	634
10.11	Additional Functions.....	634
10.11.1	Sharing Options – FTP & SAMBA.....	634
11	Calibration.....	635
11.1	Calibration Interval.....	635
11.2	Closed Case User Calibration.....	635
11.3	Equipment Required.....	635
11.4	Calibration Procedures.....	636
11.4.1	Voltage Calibration – Offset.....	636
11.4.2	Current Calibration - Offset.....	637
11.4.3	Voltage Calibration - Gain.....	638
11.4.4	Current Gain Calibration Setup Diagrams.....	640
11.4.1	Current Calibration Load Values.....	641
11.4.2	Current Calibration - Gain.....	642
11.4.3	Exit Calibration Mode.....	642
12	Warnings & Error Messages.....	643
12.1	Preface.....	643
12.2	Errors & Warnings Messages in Numeric Order.....	643

13	Service and Maintenance	671
13.1	Warnings.....	671
13.2	Authorized Service Centers.....	672
14	ModBus TCP Server / Slave Interface.....	673
14.1	ModBus TCP Interface.....	673
14.2	Modbus TCP Register Tables	673
14.3	ModBus Control Example using Python.....	688
15	CAN / CAN-FD Interface.....	689
15.1	CAN / CAN-FD Interface Option.....	689
15.2	USB to CAN Bus Adaptor Required.....	689
15.2.1	Key features and Specifications are:.....	690
15.2.2	CAN-FD Adaptor Technical Specifications	690
15.3	CAN / CAN-FD Configuration File.....	691
15.4	Downloading and installing the canfd.dcb file.....	692
15.5	Vector CANdb++ Editor Windows Software	693
15.6	Enabling or Disabling the CAN / CAN-FD interface	694
16	CE MARK Declaration of Conformity.....	696
	Index	697

Table of Tables

Table 3-1: Available options	25
Table 3-2: Load Circuit Emulaton Mode - Schematic Diagrams	37
Table 3-3: Included Accessories	39
Table 3-4: Remote Control Interfaces	39
Table 4-1: Programmable Impedance Ranges by Phase mode	43
Table 5-1: AC Input Wire Size Table	71
Table 5-2: Safety Circuits Status Monitor	75
Table 5-3: Parallel Configurations of up to four AZX units	98
Table 5-4: RS232 DB25 Tx and Rx Pin Locations	102
Table 5-5: GPIB Interface Connector Pin Assignments	102
Table 6-1: Available Menu Keys	106
Table 6-2: Available Voltage Source Mode Parameters on PROGRAM screen	109
Table 6-3: Available Current Source Mode Parameters on PROGRAM screen	110
Table 6-4: Available Load CC Setting Parameters on PROGRAM screen	113
Table 6-5: Available Load CR Setting Parameters on PROGRAM screen	115
Table 6-6: Available Load CP Setting Parameters on PROGRAM screen	119
Table 6-7: Changing Programming Resolution	128
Table 6-8: PROGRAM screen soft keys	133
Table 6-9: Available Included AZX Series® Waveforms	135
Table 6-10: Measurement Screen Soft Keys	147
Table 6-11: Three Phase Measurement Screen Soft Keys	150
Table 6-12: Individual Phase Measurement Screen Soft Keys	151
Table 6-13: Available LIST Transient Parameters	153
Table 6-14: Voltage Transient List for Example 1	154
Table 6-15: RTCA/DO160 Section 16 test number 16.5.2.1d	155
Table 6-16: Voltage Transient List for Example 1	155
Table 6-17: Available TRANSIENT EDIT screen soft keys	157
Table 6-18: Available TRANSIENT DEBUG screen soft keys	157
Table 6-19: Available TRANSIENT PROGRAM screen soft keys	158
Table 6-20: Available STEP Transient Parameters	162
Table 6-21: Available STEP PROGRAM screen soft keys	162
Table 6-22: Available STEP EXECUTION screen soft keys	163
Table 6-23: Available STEP Transient Parameters	165
Table 6-24: Available STEP PROGRAM screen soft keys	165
Table 6-25: Available STEP PROGRAM screen soft keys	166
Table 6-26: Available UNIT CONFIGURATION 1 screen soft keys	177
Table 6-27: Available UNIT CONFIGURATION 2 screen soft keys	179
Table 6-28: Available USER LIMITS SETTINGS screen soft keys	180
Table 6-29: Available RAMP TIME & SLEW RATE SETTINGS screen soft keys	181
Table 6-30: Available SLEW RATE SETTINGS screen soft keys	183
Table 6-31: Available CSC CONFIGURATION screen soft keys	183
Table 6-32: Available TRANSIENT SETTINGS screen soft keys	184
Table 6-33: Available PROGRAMMABLE IMPEDANCE screen soft keys	185
Table 6-34: Available USER INTERFACE screen soft keys	193

Table 6-35: Available USER INTERFACE screen soft keys.....	196
Table 6-36: Available ETHERNET INTERFACE SETUP screen soft keys	198
Table 6-37: Available SERIAL INTERFACE SETUP screen soft keys	199
Table 6-38: Available USB INTERFACE SETUP screen soft keys	200
Table 6-39: Available GPIB INTERFACE SETUP screen soft keys	201
Table 6-40: Available UNIT INFORMATION screen soft keys.....	204
Table 6-41: Available PARALLEL UNITS screen soft keys	205
Table 6-42: Available SYSTEM SETTINGS screen soft keys	208
Table 6-43: Available CALIBRATION MENU screen soft keys.....	214
Table 6-44: Available FIRMWARE UPDATE screen soft keys	214
Table 6-45: Available LOGGING TOOL screen soft keys.....	215
Table 7-1: Auxiliary I/O DB25 Connector Pin numbers and Signals by DB25 pin number.....	222
Table 7-2: Auxiliary I/O DB25 Connector Pin numbers and Signals by Signal Name.....	223
Table 7-3: Default Analog Output Functions	235
Table 7-4: AUX I/O Analog Input assignable Commands.....	237
Table 7-5: AUX I/O Digital Output assignable Events or Conditions.....	240
Table 8-1: Available SCPI Command Subsystems	245
Table 8-2: Available Included AZX Series® Waveforms	326
Table 8-3: Mandatory IEEE488.2 Common Commands	545
Table 8-4: Status Byte Register (STB)	549
Table 8-5: Status Event Register (ESR).....	551
Table 10-1: Supported Script Entries.....	597
Table 11-1: Required Calibration Equipment	635
Table 11-2: Setup for Voltage Offset Calibration	636
Table 11-3: Calibration Load Values Phase Mode	641
Table 12-1: Warnings and Error Messages Listing.....	670
Table 15-1: CAN-FD USB adaptor DB9 Pin Assignments.....	690
Table 15-2: CAN-FD USB Adaptor Technical Specs	691

Table of Figures

Figure 3-1: AZX Series® Basic Block Diagram	28
Figure 4-1: Output Voltage distortion into full R Load as a function of Frequency	42
Figure 4-2: AC Mode Voltage/Current range, 3300AZX Models - Three phase mode.	44
Figure 4-3: AC Mode Voltage/Current range, 3300AZX Models – Split phase mode.	44
Figure 4-4: AC Mode Voltage/Current range, 3300AZX Models – Single phase mode.	45
Figure 4-5: AC Mode Voltage/Current range, 3450AZX Models – Three phase mode.....	46
Figure 4-6: AC Mode Voltage/Current range, 3450AZX Models – Split phase mode.....	46
Figure 4-7: AC Mode Voltage/Current range, 3450AZX Models – Single phase mode.	47
Figure 4-8: AC Mode Voltage/Current range, 3550AZX Models - Three & Split-phase mode.....	48
Figure 4-9: AC Mode Voltage/Current range, 3550AZX Models – Single phase mode.	48
Figure 4-10: AZX Series Low Frequency (< 45 Hz) derating chart	49
Figure 4-12: DC Mode Voltage/Current range, 3300AZX Models- Three Channel mode.....	52
Figure 4-13: DC Mode Voltage/Current range, 3300AZX Models – Dual Channel mode.....	53
Figure 4-14: DC Mode Voltage/Current range, 3300AZX Models – Single Channel mode.....	53
Figure 4-15: DC Mode Voltage/Current range, 3450AZX Models- Three Channel mode.....	54
Figure 4-16: DC Mode Voltage/Current range, 3450AZX Models- Dual Channel mode.....	54
Figure 4-17: DC Mode Voltage/Current range, 3450AZX Models – Single Channel mode.....	55
Figure 4-18: DC Mode Voltage/Current range, 3550AZX Models- Three & Two Channel mode.	56
Figure 4-19: DC Mode Voltage/Current range, 3550AZX Models – Single Channel mode.....	56
Figure 4-20: Cabinet Dimension Drawing AZX Series® 30kVA & 50kVA Model.....	60
Figure 5-1: AC Input Line Monitor	70
Figure 5-2: AC Input Terminal Location on rear panel of AZX cabinet	71
Figure 5-3: Mains CB in OFF (lower) Position	73
Figure 5-4: Mains CB in ON (upper) Position.....	73
Figure 5-5: Grounding Floating Neutral Outputs.....	77
Figure 5-6: Input Power On/Off CB.....	77
Figure 5-7: AC or DC Output Connection Terminals Location on AZX rear panel.....	83
Figure 5-8: Three phase Wye Load Output Connections – Internal Voltage Sense.....	85
Figure 5-9: Three phase Wye Load Output Connections – External Voltage Sense	86
Figure 5-10: : FORM4 Two Outputs Load Output Connections	87
Figure 5-11: : FORM5 Three Outputs Load Output Connections	88
Figure 5-12: Three phase Delta Load Output Connections – Internal Voltage Sense	89
Figure 5-13 Three phase Delta Load Output Connections – External Voltage Sense.....	90
Figure 5-14: Three phase Delta Load Output Connections on AZX-W	91
Figure 5-15: Three Phase AC Star versus Delta Connections.....	92
Figure 5-16: Single phase Load Output Connections.....	94
Figure 5-17: DC Output Series Connection on AZX-W	95
Figure 5-18: External Voltage Sense Connector Signal Connections.....	97
Figure 5-19: Parallel Mode Bus Connections using parallel bus cable	100
Figure 5-20: Remote Control Interface Connector Locations on Rear Panel	101
Figure 6-1: AZX Series® Front Panel View.....	103
Figure 6-2: PROGRAM Screen - Voltage Source Mode	108
Figure 6-3: PROGRAM Screens Current Source Mode.....	110
Figure 6-4: PROGRAM Screens Constant Current Load Mode	112

Figure 6-5: Three Phase AC mode Default Phase Rotation	126
Figure 6-6: Three Phase AC mode Reversed Phase Rotation	127
Figure 6-7: Phase Mode Data Entry Status Field	129
Figure 6-8: Waveform with no Smoothing Filter Applied.....	136
Figure 6-9: Same Waveform with maximum smoothing Filter Applied	136
Figure 6-10: Measurement Screens 1 through 2.....	143
Figure 6-11: Measurement Screens 3 through 4.....	143
Figure 6-12: Voltage Transient Example 1.....	154
Figure 6-13: RTCA/DO160 Section 16 test number 16.5.2.1d	155
Figure 6-14: Blank TRANSIENT PROGRAM screen	156
Figure 6-15: TRANSIENT VIEW Edit Mode	156
Figure 6-16: TRANSIENT Debug mode screen	157
Figure 6-17: Transient shown in STEP Entry Mode.....	159
Figure 6-18: Transient shown in SEGMENT Entry Mode	159
Figure 6-19: Available User Waveforms in Transients.....	160
Figure 6-20: USER LIMIT SETTINGS Screen	179
Figure 6-21: RAMP TIME & SLEW RATE SETTINGS Screens	180
Figure 6-22: PROGRAM MEMORY screen.....	182
Figure 6-23: CSC CONFIGURATION screen	183
Figure 6-24: SYSTEM MAIN MENU 1	188
Figure 6-25: SYSTEM MAIN MENU 2	188
Figure 6-26: ERROR & EVENT QUEUE Screen	190
Figure 6-27: FAULT INFORMATION screen	190
Figure 6-28: INTERFACE SETUP Screen	191
Figure 6-29: ETHERNET INTERFACE SETUP Screen	197
Figure 6-30: SERIAL INTERFCE SETUP Screen	199
Figure 6-31: USB INTERFACE SETUP Screen	200
Figure 6-32: USB INTERFACE SETUP Screen	201
Figure 6-33: REMOTE INHIBIT Setup Screen.....	202
Figure 6-34: UNIT INFORMATION Screen	204
Figure 6-35: PARALLEL UNITS Screen	205
Figure 6-36: SYSTEM SETTINGS Screen.....	207
Figure 6-37: MEMORY MANAGMENT Screen.....	208
Figure 6-38: CALIBRATION MENU Screen.....	213
Figure 6-39: FIRMWARE UPDATE Screen	214
Figure 6-40: REMOTE SUPPORT Screen.....	215
Figure 6-41: Remote Support REPORT Screen.....	215
Figure 7-1: DB25 Connector AUX I/O Pin Locations	221
Figure 7-2: DB25 Connector REAL TIME I/O with H option Pin Locations	224
Figure 7-3: External Trigger Input Timing	226
Figure 7-4: External Sync Input Pulses.....	227
Figure 7-5: External Sync Input Sync Status Indication	228
Figure 7-6: External Sync Input Sync Lost Status Indication	228
Figure 7-7: Transient Trigger Output Pulse	230
Figure 7-8: Function Strobe Output Pulse	230
Figure 7-9: Phase A Zero Phase Sync Output Pulse	231

Figure 8-1: OUTP:ZERO Command Ramp and Dwell settings	273
Figure 8-2: Status Byte Logical Model	550
Figure 8-3: Standard Event Register (ESR) Model	551
Figure 8-4: SCPI Status Registers Model.....	553
Figure 9-1: PPST USB Drivers visible in Windows Device Manager	555
Figure 10-1: LXI Web Server Home Screen	557
Figure 10-2: ACCESS CONTROL Dialog Screen	559
Figure 10-3: Remote Access Control Request Dialog	560
Figure 10-4: Remote Access Control IP Filter screen.....	561
Figure 10-5: Waveform Edit defined using 4 data points.....	591
Figure 10-6: Waveform Edit defined using 16 data points.....	591
Figure 11-1: Voltage Calibration Equipment Setup – 1 or 3 Phase Mode – Phase A.....	638
Figure 11-2: Current Calibration Equipment Setup – 3 Phase Mode – Phase A.....	640
Figure 11-3: Current Calibration Equipment Setup – 1 Phase Mode	641

1 Contact Information

AMERICA / CANADA

Pacific Power Source

2802 Kelvin Avenue, Suite 100

Irvine, CA 92614

USA

Phone: +1(949) 251-1800

Fax: +1 (949) 756-0756

Email: support@pacificepower.com

EUROPE

Pacific Power Source Europe GmbH.

Binzigstraße 21

77876 Kappelrodeck

Germany

Phone: +49(0)7842-99722-20

Fax: +49(0) 7842-99722-29

Email: info@pacificepower.eu

CHINA

PPST Shanghai Co. Ltd.

4 floors , building 2, No. 2185 Lai Fang Road

Jiu Ting Town, Song Jiang District

Shanghai 201615

Phone: +86-21-6763-9223

Fax: +86-21-5763-8240

Email: support@pacificepower.comWeb: <http://pacificpower.com>

2 Safety & Warranty Information

2.1 Limited Warranty

Pacific Power Source, Inc. (PPS) warrants each unit to be free from defects in material and workmanship. For the period of two (2) years from the date of shipment to the purchaser, PPS will either repair or replace, at its sole discretion, any unit returned to the PPS factory in Irvine, California or one of its designated service facilities. It does not cover damage arising from misuse of the unit or attempted field modifications or repairs. This warranty specifically excludes damage to other equipment connected to this unit.

Upon notice from the purchaser within (30) days of shipment of units found to be defective in material or workmanship, PPS will pay all shipping charges for the repair or replacement. If notice is received more than thirty (30) days from shipment, all shipping charges shall be paid by the purchaser. Units returned on debit memos will not be accepted and will be returned without repair.

This warranty is exclusive of all other warranties, expressed or implied.

2.2 Service and Spare Parts Limited Warranty

PPS warrants repair work to be free from defects in material and workmanship for the period of ninety (90) days from the invoice date. This Service and Spare Parts Limited Warranty applies to replacement parts or to subassemblies only. All shipping and packaging charges are the sole responsibility of the buyer. PPS will not accept debit memos for returned power sources or for subassemblies. Debit memos will cause return of power sources or assemblies without repair.

This warranty is exclusive of all other warranties, expressed or implied.

2.3 Safety Information

This chapter contains important information you should read BEFORE attempting to install and power-up PPS Equipment. The information in this chapter is provided for use by experienced operators. Experienced operators understand the necessity of becoming familiar with, and then observing, life-critical safety and installation issues. Topics in this chapter include:

- Safety Notices
- Warnings
- Cautions
- Preparation for Installation
- Installation Instructions

Make sure to familiarize yourself with the **SAFETY SYMBOLS** shown on the next page. These symbols are used throughout this manual and relate to important safety information and issues affecting the end user or operator.

SAFETY SYMBOLS



Direct current (DC)



Alternating current (AC)



Both direct and alternating current



Three-phase alternating current



Protective Earth (ground) terminal



On (Supply)



Off (Supply)



Fuse



Caution: Always consult this manual when you see this warning symbol marking in order to familiarize yourself with the nature of the potential hazard and actions to be taken to avoid them.



Caution, risk of electric shock

2.4 Safety Notices

SAFETY SUMMARY

The following general safety precautions must be observed during all phases of operation, service, and repair of this instrument. Failure to comply with these precautions or with specific warnings elsewhere in this manual violates safety standards of design, manufacture, and intended use of the instrument. Pacific Power Source assumes no liability for the customer's failure to comply with these requirements.



WARNING: CLASS 1 INSTRUMENT

This product is a Safety Class 1 instrument (provided with a protective earth terminal). The protective features of this product may be impaired if it is used in a manner not specified in the operation instructions.



AVERTISSEMENT: APPAREIL CLASSE 1

Cet produit est un appareil Classe 1 (avec terre de protection). Les dispositifs de sécurité de ce produit peuvent être altérés si le produit est utilisé d'une manière non spécifiée dans le manuel d'utilisation.



WARNING: ENVIRONMENTAL CONDITIONS

This instrument is intended for indoor use in an installation category II, pollution degree 2 environments only. It is designed to operate at a maximum relative humidity of 80% for temperatures up to 40 °C and at altitudes of up to 2000 meters. Refer to the specifications tables for the ac mains voltage requirements and ambient operating temperature range.



AVERTISSEMENT: CONDITIONS ENVIRONNEMENTALES

Cet appareil est destiné à une utilisation intérieure dans une installation de catégorie II, degré de pollution 2. Il est conçu pour fonctionner sous humidité relative maximale de 80%, pour des températures allant jusqu'à 40°C et à des altitudes allant jusqu'à 2000 m. Se reporter aux tableaux de spécifications pour les exigences en terme de tension secteur et plage de température ambiante de fonctionnement.

**CAUTION: USE COPPER CONDUCTOR WIRING ONLY**

Use only copper conductor (CU) wiring for all AC Input, AC and DC Output and Ground Connections.

**ATTENTION: UTILISER UNIQUEMENT LE CÂBLAGE DU CONDUCTEUR EN CUIVRE**

Utilisez uniquement un câblage à conducteur en cuivre (CU) pour toutes les connexions d'entrée CA, de sortie CA et CC et de mise à la terre.

**CAUTION: BEFORE APPLYING POWER**

Verify that the product AC input specifications noted on the model tag matches the available utility line voltage and frequency.

**ATTENTION: AVANT DE METTRE SOUS TENSION**

Vérifier que les spécifications de tension d'alimentation de l'équipement notées sur l'étiquette sont bien compatibles avec la tension et fréquence secteur disponibles.

**SAFETY NOTICE: GROUNDING**

This product is a Safety Class 1 instrument (provided with a protective earth terminal). To minimize shock hazard, the instrument chassis or cabinet must be connected to an electrical safety ground. The instrument must be connected to the AC power supply mains through a properly rated three phase power cable with protective earth (L1-L2-L3-E). Any interruption of the protective (grounding) conductor or disconnection of the protective earth terminal will cause a potential shock hazard that could result in personal injury.

This instrument is equipped with a line filter to reduce electromagnetic interference and must be properly grounded to minimize electric shock hazard. Operation at line voltages or frequencies in excess of those stated on the model type plate may cause leakage currents in excess of 5.0 mA peak.

**REGLE DE SECURITE: MISE A LA TERRE**

Ce produit est un équipement de Classe 1 (muni d'une borne de mise à la terre). Pour minimiser le risque de choc électrique, le châssis de l'appareil ou de l'armoire/rack doit impérativement être relié à une terre de sécurité électrique. L'appareil doit être branché sur le secteur d'alimentation électrique à courant alternatif par un câble d'alimentation triphasé approprié avec terre de protection (L1-L2-L3-PE). Toute interruption de la mise à la terre de protection ou de déconnexion de la borne de terre causera un risque de choc électrique qui pourrait entraîner des blessures.

Cet appareil est équipé d'un filtre secteur pour réduire les interférences électromagnétiques et doit être correctement mis à la terre afin de minimiser le risque de choc électrique. Le fonctionnement sous tensions et fréquences supérieures à celles indiquées sur l'étiquette peut provoquer des courants de fuite de plus de 5,0 mA peak.

**WARNING: DO NOT OPERATE IN AN EXPLOSIVE ATMOSPHERE**

Do not operate the instrument in the presence of flammable gases or fumes.

**AVERTISSEMENT: NE PAS UTILISER SOUS ATMOSPHERE
EXPLOSIVE**

Ne pas faire fonctionner l'appareil en présence de gaz ou vapeurs inflammables.

**WARNING**

The AC input connections must include a disconnect device (an external switch or circuit-breaker) as part of the installation. The disconnect device must be suitably located and easily reached and must be marked as the disconnecting device for the equipment. The disconnect device must disconnect all line conductors simultaneously.

An external overcurrent protection device must be provided (by, e.g., fuses or circuit breaker). The breaking capacity of the overcurrent protection device should be compatible with the current rating of the installation.

A minimum of basic insulation is required between mains-connected parts of opposite polarity on the supply side of the overcurrent protection device.

Overcurrent protection devices shall not be fitted in the protective conductor. Fuses or single pole circuit-breakers shall not be fitted in the neutral conductor of multi-phase equipment.

Installation should be in accordance with ANSI/NFPA 70, NEC.



AVERTISSEMENT

Les connexions d'entrée AC doivent inclure un dispositif de déconnexion (un commutateur externe ou disjoncteur) dans le cadre de l'installation. Le dispositif de déconnexion doit être convenablement situé et facilement accessible et doit être marqué comme le dispositif de déconnexion de l'équipement. Le dispositif de déconnexion doit déconnecter tous les conducteurs de ligne simultanément.

Un dispositif de protection de surintensité externe doit être fourni (par exemple, par des fusibles ou coupe-circuit). Le pouvoir de coupure du dispositif de protection contre les surintensités doit être compatible avec le courant nominal de l'installation.

Un minimum d'isolation de base est nécessaire entre les parties de réseau connecté de polarité opposée sur le côté d'alimentation du dispositif de protection contre les surintensités.

Les dispositifs de protection contre les surintensités ne doivent pas être installés dans le conducteur de protection. Fusibles ou simples disjoncteurs ne doivent pas être installés dans le conducteur neutre des équipements multi-phasés.

L'installation doit être conforme à la norme ANSI / NFPA 70, NEC.



WARNING: DO NOT SUBSTITUTE PARTS OR MODIFY INSTRUMENT

Because of the danger of introducing additional hazards, do not install substitute parts or perform any unauthorized modification to the instrument. Return the instrument to a Pacific Power Source Sales and Service Office for service and repair to ensure that safety features are maintained.

Instruments that appear damaged or defective should be made inoperative and secured against unintended operation until they can be repaired by qualified service personnel.

**AVERTISSEMENT: NE PAS REMPLACER DE PIÈCES ET DE COMPOSANTS – NE PAS MODIFIER L'ÉQUIPEMENT**

En raison d'introduction de dangers supplémentaires, ne pas installer des pièces de rechange et ne pas effectuer de modification de l'équipement non autorisés. Retourner l'appareil à un bureau de ventes et services Pacific Power Source pour le service et la réparation afin d'assurer le maintien des caractéristiques de sécurité. Les appareils qui semblent endommagés ou défectueux doivent être rendus inopérants et protégés contre le fonctionnement involontaire jusqu'à ce qu'ils puissent être réparés par un personnel qualifié.

**CAUTION: INSTRUMENT LOCATION**

Do not position this instrument in such a way as to block easy access to any mains disconnect device or in any way that makes it difficult to operate the mains disconnect device.

**ATTENTION: EMBLACEMENT DE L'APPAREIL**

Ne pas placer cet appareil de manière à bloquer l'accès facile à tout débranchement du réseau électrique ou d'une façon qui rende difficile l'opération de débranchement du réseau électrique.

3 Product Overview

This chapter provides an overview of the PPS AZX Series® programmable regenerative power sources. It introduces the reader to general operating characteristics of these power supplies.

3.1 General Description

The Pacific Power Source (PPS) AZX Series® power sources are designed to provide accurate, stable and clean AC or DC power to a unit under test. The AZX can also be used as a regenerative AC or DC load by adding the –L Load option. The PPS AZX Series® power supply can be operated from the front panel (manual mode) or using USB, LAN (Ethernet), GPIB or RS232 remote control.

The performance of the AZX Series® power source models are detailed in section 4, “Technical Specifications”. This manual covers standard AZX Series® models. Modified units are generally shipped with a manual addendum as a supplement to this manual. The manual addendum covers specific modifications from the standard model(s).

3.2 Product Features

The following key characteristics apply to all AZX Series® models;

- Fully programmable electronic power source with advanced controller functions.
- Bidirectional power flow operation with energy recovery to the AC grid.
- AC, DC and AC+DC output modes.
- Operating Modes:
 - AC, DC and AC+DC Voltage Source
 - AC, DC and AC+DC Current Source
 - Optional AC or DC Load Operation. (Option L).
 - Hardware in the Loop Amplifier (Option H).
- Single, Split and Three phase modes.
- Fully remote control of all settings and metering read back.
- Dual voltage ranges.
- Over voltage, over current and over power protection.
- Residual Current Monitoring AC Input Line protection.
- AC Input voltage phase-rotation, phase-balance and phase-loss protection
- Input transformer overtemperature protection
- External voltage sense.
- Programmable Output Impedance (R + L)
- Auxiliary I/O – Analog and Digital.

3.3 Available Options

The following options may be specified at the time of ordering. These options are not field-installable. See technical specification for more details. . See section 7.3, “Auxiliary I/O” on page 7.3 for alternate pinout configuration on Option H equipped AZX models.

Option Suffix	Description
Option B	Configuration provision for use of AZX with ECTS2 EMC test systems
Option C	Interharmonics Generator for IEC 61000-4-13 Immunity test. Includes Ects_413Gui Windows software for IEC 61000-4-13 test and report generation.
Option D	Safety Performance Level D upgrades to meet specific EU factory equipment safety standard.
Option H	Real Time I/O option for PHIL applications. This option changes some of the analog I/O inputs and output to high-speed versions to support real-time power hardware in the loop applications (PHIL).
Option L	Electronic AC or DC Load Operation.
Option W	Isolated Output Neutrals. Standard AZX output neutral terminals are shorted together. With option W, each phase has its own isolated Neutral connection. (NA, NB, Nc).

Table 3-1: Available options

3.3.1 Option B Description

The B option configures the voltage and or current maximum outputs to work with the ECTS2 Series Harmonics and Flicker test systems. It is only required on AZX power sources that are part of an ECTS2 EMC test system.

3.3.2 Option C Description

The C options add interharmonics generation to the power source controller feature set. This option is required to support IEC 61000-4-13 Harmonics and Interharmonics compliance testing. It can also be used to generate interharmonics on the output of the power source for other immunity test purposes. For IEC 61000-4-13 compliance testing, the Ects_413Gui Windows Test software is available to execute all tests called out in the IEC standard.

3.3.3 Option D Description

The D option adds performance level class D safety features in accordance with EN ISO 13849-1 standard for up to two AZX cabinets. With this option, the following features are added:

- Remote reset - the unit's circuit breaker (CB) will not trip. It can be reset with an external 24Vdc signal.
- No Idle consumption.

- Built-in redundant contactor turn-off (required by Performance Level class D).
- Parallel safety connection. Emergency shutoff will turn off the entire system. Note, applies only if all parallel AZX units are configured with the D option. If one or more AZX units in the system do not have the D option, the system loses almost all the previous advantages, but it can be used that way if desired/needed.

3.3.4 Option H Description

Option H adds a fast analog I/O subsystem intended for use with Power Hardware in the Loop test systems. This is a real-time analog interface that is compatible with most PHIL hardware units, although a specific interface cable may be required to connect.

3.3.5 Option L Description

Option L adds electronic AC and DC load mode functionality to the AZX power source turning it into a fully functional programmable load. Standard AZX modes remain available to select if this option is configured.

3.3.6 Option W Description & Connection Considerations

Option W means the three output neutral terminals are not shorted together inside the AZX unit. For three phase load applications, the user will have to short the neutral outputs at the back of the AZX or at the load. This option allows each phase / output to be used as an independent Source or Load (if configured with Option L). It also supports output FORM4 and FORM5.

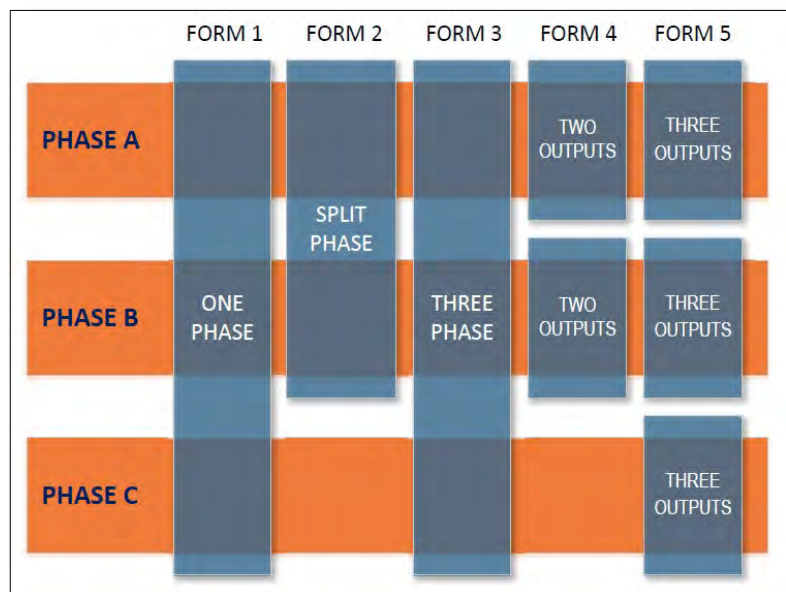

Consideration for AZX operating modes and output connections with standard AZX versus AZX with W Option are as follows:

The standard AZX in three phase mode has 3 sources (phases) in a Y (star) connection, i.e. all neutrals are connected together with an internal shorting busbar. In voltage mode they function as three **voltage sources**, in current or load mode they function as three **current sources**.

The W Option means this internal shorting busbar has been removed, so it converts the AZX to three independent (and thus floating) voltage or current sources, similar to having three batteries, which can be externally connected in Y (star), delta, or even in series.”

Thus, a standard AZX is identical to an AZX -W with its three Neutral terminals shorted externally.”

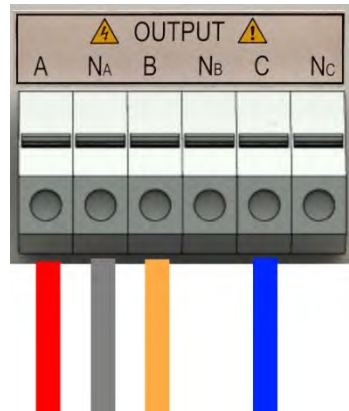

Standard AZX Output

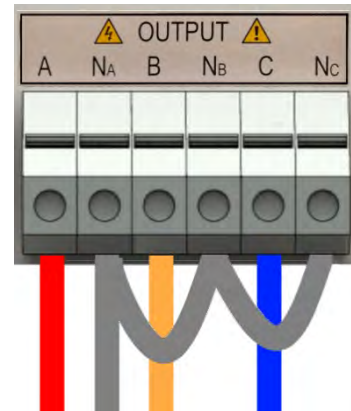

AZX with W Option Output

With the AZX working in voltage mode, if the outputs are connected in delta mode it is equivalent to connect voltage sources in parallel, which is a problem since voltage sources that are connected in parallel, will “fight” to control the voltage. This results in at least one of them tripping an overcurrent protection.

Delta connection of the AZX output is mostly meant to be used in load and current source mode. In general, voltage mode should be used with star (Y) connection of the outputs.

Something similar happens with a standard AZX (with star connection) in load (or current mode) with the neutral terminals **not** connected to the voltage source (unit under test). It’s equivalent to have current sources in parallel, which is not permissible as one phase will saturate its output trying to control the current.

To summarize:

- AZX in three phase voltage mode, output “should” be connected in star (Y), as the standard AZX.
- AZX in three phase current or load mode, output “should” have the Neutral connected to the voltage source, or changed to delta connection (with W option).

With the AZX working as a load (or current source), these are the possible combinations:

- AZX (load) in star + UUT (voltage source) in star = WORKS (with neutral connection to the AZX)
- AZX (load) in star + UUT (voltage source) in delta = DOES NOT WORK => need W option + delta connection in AZX
- AZX-W (load) in delta + UUT (voltage source) in delta = WORKS
- AZX-W (load) in delta + UUT (voltage source) in star (no neutral connection) = WORKS

One more important consideration is that the AZX in load mode is based on **current sources**. So even in “resistive” emulation mode, the output power stages work as current sources and don’t behave as actual resistors. So, they cannot have a current source connected to them as a unit under test. The unit under test **MUST** be a voltage source. Refer to section 5.13, “Load Connections” on page 82 for more information.

3.3.7 Multi-unit Parallel Systems Option Support

AZX systems consisting of two or more AZX units are controlled by only one of the AZX units called the Master unit. All other units connected through the parallel DVI cable interface act as Auxiliary units and their controller is disabled. Only those options installed on the Master unit are available for use. Thus, if the unit used as the Master is not configured with an option, that option is not available to use at the parallel system level.

3.4 Block Diagram

The block diagram of the AZX power source is shown in Figure 3-1 below. It shows the key functional blocks for the three phase AZX models.

Using a three-phase AC line input isolation transformer followed by a synchronous rectifier stage, the AZX produces a regulated bi-polar DC bus that provides power to the dual full bridge output inverter stages for each phase. The two output inverters for each phase can be switched in series or parallel to select high or low voltage ranges. Output power remains the same in either range. This is illustrated in the diagram below.

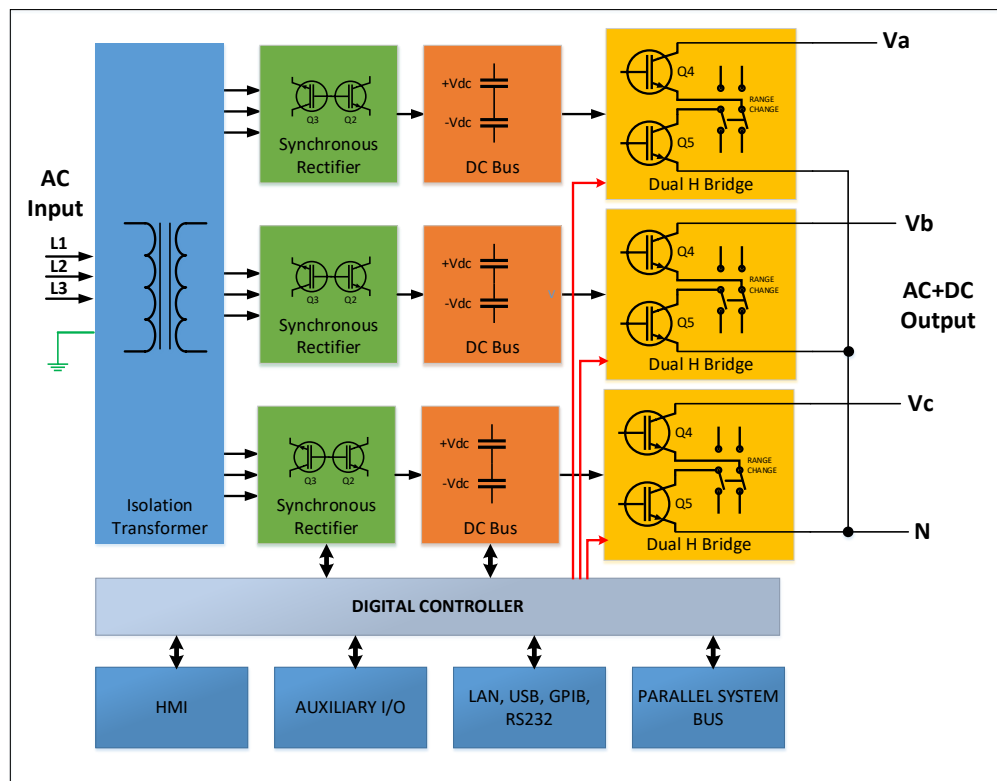

Figure 3-1: AZX Series® Basic Block Diagram

3.5 Controller Description

The AZX Series® power supplies use an advanced command processor that communicates with the internal power stages using several high-speed communication buses and with the outside world through a variety of interfaces. One of these interfaces is the front panel keyboard and LCD display, which supports manual operation of the power source.

The command processor handles all user inputs as well as any analog or digital input provided to the unit. All power stages are operated autonomously and take input from the main command processor. For larger power configurations consisting for multiple chassis, the master unit command processor communicates to all chassis that are connected on the master/auxiliary parallel interconnect bus.

3.6 Measurement Read-back

The voltage, frequency and current limit settings of the power source can be set from the front panel or over any of the available digital remote control interfaces. During operation, the source output voltage, frequency, current and power can be read back for each of the available output phases.

Notes:

- In source mode of operation, current and power measurements will be displayed with a minus sign and a green back ground color when the AZX is sending power back to the grid.
- In Load mode of operation (Option L), current and power measurements will be shown with a minus sign and a green back ground color.

3.7 Load Mode of Operation (Option L)

This section provides a basic overview of the electronic load functions of the AZX Series units when equipped with the Electronic Load mode option (Option L). If your unit does not have this option, you can skip this section.

Units equipped with Option L will have the letter “L” appended to the model number when queries over the bus with the *IDN? Command. For example, a 3550AZX with Option L and AC input configured for 380~400Vac would return:

```
PPSC,3550AZX-4L,0,3.5.1
```

To operate the AZX as an electronic load i.s.o of a source, the mode needs to be set to LOAD in the UNIT CONFIGURATION menu using the “**Operating Mode**” field. (Section 6.7.1, page 175). Select “**Active Load**” to enable load operation.

Note: When used as a load, the AZX output becomes and input and is normally connected to a voltage source type EUT.

The other settings like Voltage Range and Coupling serve the same purpose as in Source mode.

The “Load Type” setting only appears in Load Mode and allows selection between the following load operation modes:

- Constant Current
- Constant Resistance
- Constant Power
- Circuit Emulation

In load mode, most energy absorbed from the unit under test is returned to the utility grid. This reduces the amount of heat generated by the AZX compared to a conventional dissipative load considerably.

3.7.1 Constant Current (CC) Mode

This is the most commonly used mode of operation when testing a voltage source such as an AC or DC power supply, battery or Power converter. In this mode of operation, the load will sink a constant level of AC and/or DC current as set by the user, regardless of any voltage variations. A real time feedback loop ensures a stable current under any voltage variation on the input.

Both AC and DC current can be set independently as needed.

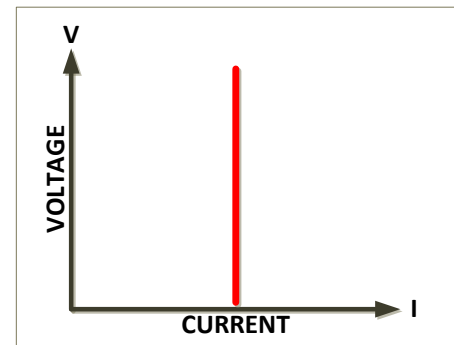

This mode is recommended for load regulation testing, loop stability testing, battery discharge testing and any other form of voltage regulation loop testing.

Available features in CC mode are:

- Transient programming – Set points are in current.
- Analog programming – The units are in current. For RMS modes, the input signal waveshape controls the current waveform and amplitude of the analog input signal defines current amplitude.
- User Limits.
- Programmable Slew Rate.
- Interharmonics and Harmonics Generation.

3.7.2 Constant Resistive (CR) Mode

In Constant Resistance mode, the load will sink AC and/or DC current directly proportional to the sensed input voltage. The ratio between voltage and current is linear per ohms law and can be set by the user within the operating range of the load. The current is defined by the formula shown here where R is the set value in CR mode and V is the dc input voltage from the unit under test.

$$I = V/R$$

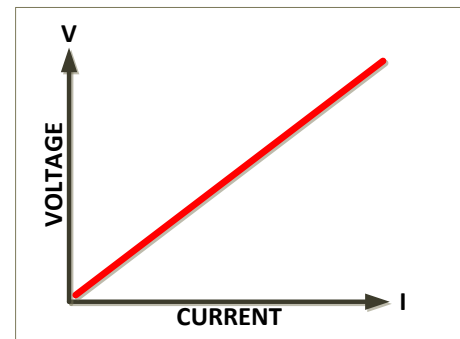

The AZX supports four different Constant Resistive Modes:

- Resistance RMS
- Conductance RMS
- Instant Resistance (Real-Time)
- Instant Conductance (Real-Time)

Coupling can be set to AC, DC or AC&DC. In AC&DC mode, AC and DC current can be programmed independently. Each mode offers different capabilities that are suited for a wide range of applications.

Available features in CR mode are:

- Transient programming – Same as Current Mode but set points are in resistance or inductance depending on selected mode.
- Analog programming – The units are in resistance or conductance. For RMS modes, the input signal waveshape controls the current waveform but the amplitude of the analog input signal defines the resistance or the conductance.
- User Limits - Same as constant current load mode but the limits are in resistance or conductance depending on the type.
- Slew Rate - Same as constant current load but the slew rates are in resistance or conductance depending on the type.

Not available in CR mode:

- Interharmonics and Harmonics Generation.

The following sections explain each mode in more detail.

3.7.2.1 Constant Resistance RMS Mode

This mode programs both AC and DC resistance in Ohms. An “Infinite” value setting is available for all resistance modes/.

For AC applications, the current waveform can be set to a sinewave (SINE), the RECTIFIER waveform or a user defined arbitrary waveform. The RECTIFIER Waveform is available for RMS modes only.

The output current is computed as:

$$Out = \frac{Vac}{Sac} * waveform(t) + \frac{Vdc}{Sdc}$$

Where:

- Vac is the measured voltage AC
- Vdc is the measured voltage DC
- Waveform is the normalized arbitrary or rectifier one.
- Sac is the AC setpoint
- Sdc is the DC setpoint

The SYNC mode setting allows the current to be phase synced with the AC input voltage waveform so the current syncs up to the voltage and the phase angle of the current can be shifted as needed. Thus, it allows the Power Factor to be adjusted. Any power factor load from -1.0 (lagging) to +1.0 (leading) can be simulated.

For DC applications, the SYNC mode is turned off allowing an AC+DC current waveform to be used based on resistance settings in $I_{rms} = V_{dc} / R_{prog}$

Note: Analog programming using the AUX I/O input function controls the current waveform but the RMS value is programmed in Ohms.

3.7.2.2 Constant Conductance RMS Mode

This mode is the inverse version of the Constant Resistance mode. Instead of setting a Resistance value (Ohms), the user programs in Conductance (Siemens = 1 / Ohms).

The advantage of this somewhat unusual mode of operating is that a zero conductance setting results in zero Amps of current being drawn by the load. In Constant Resistance mode, a zero set value is not possible as it would require infinite current.

3.7.2.3 Instant Resistance (Real-Time) Mode

This mode programs both AC and DC resistance in Ohms just like the CR RMS mode but the SINE or arbitrary waveform selected defines the resistance setting as a function of time, not the actual current. This mode is the most versatile CR mode available.

One good example of using this mode is to emulate a DC only resistance so the current waveform will follow the input voltage waveform.

This mode can be synced or not as well. Non synced is useful with a DC input voltage to generate an AC waveform that defines a changing resistance value in real-time.

Note: Analog programming using the AUX I/O input function controls the resistance waveform in real-time.

This mode supports Transients, Ramp Time and Slew Rate programming.

Summarizing, the following commonly found DC Load Modes can be supported with the Constant Resistance Real-Time mode:

- CR Mode
- CR + CV Mode *(with some additional commands)*

3.7.2.4 Instant Conductance (Real-Time) Mode

This mode is the same as the resistance Real-Time mode but the set points and waveform is the conductance of the load instead of resistance.

3.7.3 Constant Power (CP) Mode

In Constant Power mode, the DC load will attempt to maintain the programmed Power dissipation by sinking more or less current at the voltage sensed. The current is defined by the formula shown below.

$$I = P/V$$

The constant power has also three modes, very similar to constant resistance:

- Apparent Power RMS Mode
- Active Power RMS Mode
- Instant Power Mode (Real-Time)

In CP mode the setpoints are in power (kW) or KVA. The units generate the current based on the voltage measurement and the load input sense points. All the CP types have the sync control.

Available features in CR mode are:

- Transient programming – Same as Current Mode but set points are in KW or KVA depending on selected mode.
- Analog programming – The units are in KW or KVA. For RMS modes, the input signal waveshape controls the current waveform but the amplitude of the analog input signal defines the KW or KVA level.
- User Limits - Same as constant current load mode but the limits are in KW or KVA depending on the type.
- Slew Rate - Same as constant current load but the slew rates are in KW or KVA depending on the type.

Not available in CP mode:

- Interharmonics and Harmonics Generation.

The following sections explain each mode in more detail.

3.7.3.1 Apparent Power RMS Mode

This mode sets the kVA level using the current waveform. This mode can be Synced to allow phase shifting with respect to an AC input voltage. It can also be unsynced which is appropriate for DC input voltage applications.

An AC rectifier waveform is available in this mode based on a programmable Current Crest factor setting.

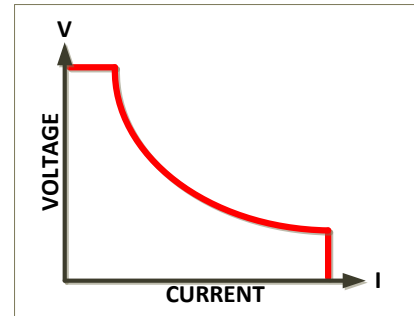

When a phase shift is programmed in Synced mode, the amplitude of the AC waveform will be adjusted (increased or decreased as needed) to maintain the active power level programmed by the user.

The output current is computed as:

$$Out = \frac{Sac}{V_{rms}} * waveform(t) + \frac{Sdc}{V_{rms}}$$

Where:

- Vrms is the measured voltage RMS
- Waveform is the normalized arbitrary or rectifier one
- Sac is the AC setpoint
- Sdc is the DC setpoint

The following less common Load modes can be emulated using this mode:

- Constant VA mode (CVA)
- Constant VA mode + Phase Shift

3.7.3.2 Active Power RMS Mode

The Active Power (aka True Power) RMS mode is equivalent to the Apparent Power RMS Mode but control the true power or active power.

An AC rectifier waveform is available in this mode based on a programmable Current Crest factor setting.

When a phase shift is programmed in Synced mode, the amplitude of the AC waveform will be adjusted (increased or decreased as needed) to maintain the active power level programmed by the user.

The output current is computed as:

$$Out = \frac{Sac}{Vac * \cos(\varphi)} * waveform(t) + \frac{Sdc}{Vdc}$$

Where:

- Vac is the measured voltage AC
- Vdc is the measured voltage DC
- Waveform is the normalized arbitrary or rectifier one
- Sac is the AC setpoint
- Sdc is the DC setpoint
- Cos(phi) is the cosine of the angle between voltage and current

The following Load modes can be emulated using this mode:

- CP Mode (CP)
- CP Mode + Phase Shift

3.7.3.3 Instant Power Mode (Real-Time)

The Active Power (aka True Power) mode is equivalent to the Apparent Power RMS Mode but in this mode the AC waveform represents the Active Power in real-time.

For AC, the arbitrary waveform controls the instant resistance as follows:

$$Out(t) = \frac{S_{ac}}{V(t)} * waveform(t) + \frac{S_{dc}}{V(t)}$$

Where:

- Vac is the measured voltage AC
- Vdc is the measured voltage DC
- Waveform is the normalized arbitrary or rectifier one
- Sac is the AC setpoint
- Sdc is the DC setpoint
- Cos(phi) is the cosine of the angle between voltage and current

The following DC Load modes can be emulated using this mode:

- CP Mode (CP)
- CP + CV Mode

However, this load mode has several uses for AC test applications as well.

3.7.4 Circuit Emulation Mode

This electronic load mode allows emulation of a wide range of AC circuits. See table on next page for schematic diagrams. The following circuits can be emulated in this operating mode.

- Resistor
- Series RL
- Series RC
- R // Series RL
- R // Series RC
- R (L // C)
- L (R // C)
- C (R // L)
- Series RLC
- R // Series RLC
- Series RL // Series RC
- R // Series RL // Series RC
- Series RL (R // C)
- Rectifier Single Phase (Rectifier + Series RL + Parallel RC)
- Rectifier Three Phase (Rectifier + Series RL + Parallel RC)

Equivalent Circuit Diagrams

Mode	Circuit Diagram	Mode	Circuit Diagram
R		Series RLC	
Series RL		R // Series RLC	
Series RC		Series RL // Series RC	
R // Series RL		R // Series RL // Series RC	
R // Series RC		Series RL (R // C)	
R (L // C)		Rectifier Single Phase	

Mode	Circuit Diagram	Mode	Circuit Diagram
L (R // C)		Rectifier Three Phase	
C (R // L)			

Table 3-2: Load Circuit Emulation Mode - Schematic Diagrams

Note: This Load mode of operation does **not** support the following functions:

- Transient Programming
- Analog Programming
- Interharmonics & Harmonics
- User Selectable Waveforms & Waveform Editor
- Phase Rotation setting
- User Limit settings
- Ramp & Slew modes

3.7.5 Inrush Current Simulation Mode

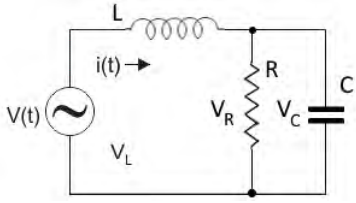
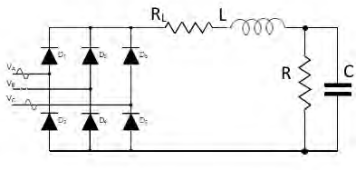
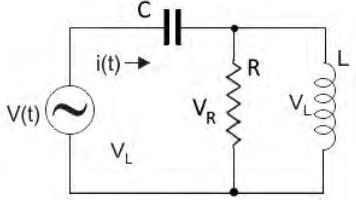
The special mode applies to both Current Source and Electronic Load modes of operation as either mode controls current and is used to create typical inrush current scenarios for testing the ability of a power source design to handle challenging inrush current demands.

Examples of current events that can be programmed using this operating mode are shown in the figure below. This current waveform shows both rectified peak currents as caused by a three-phase diode bridge capacitor non-power corrected circuit as well as subsequent power factor corrected current waveforms for a three phase AC input product. The various time periods and current waveshapes can be programmed by the user in both amplitude, duration, waveform etc.

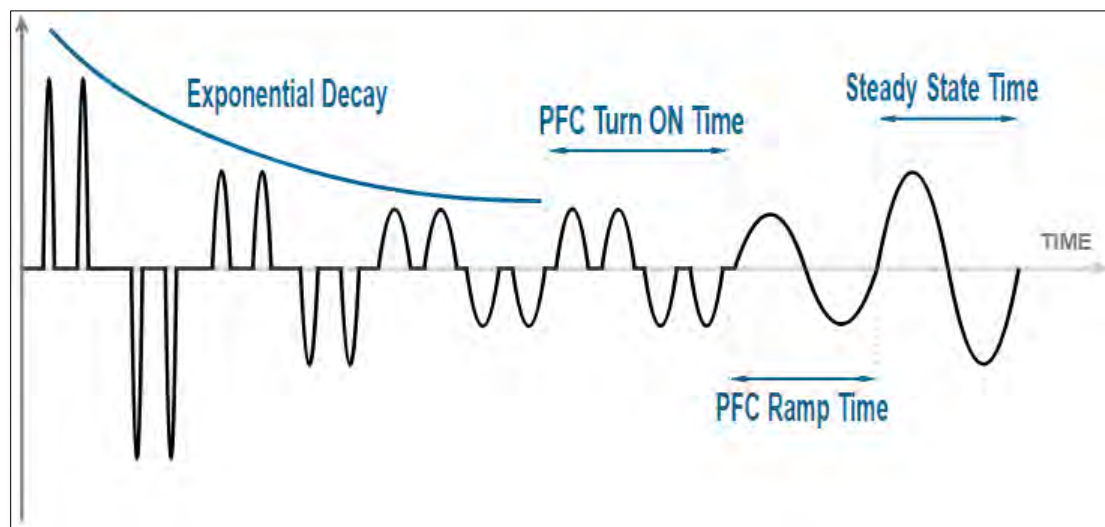

This mode of operation uses the inherent transient sequence programming functions of the AZX Series unit but eliminates the need for tedious transient list sequence programming by allow a higher level of data entry mode using inrush current decay rate settings, PFC turn on delay setting and steady state setting definitions provided by the user.

This section provides an overview of the use of this functionality. Note that the “L” Load Option is required to use this functionality.

Note: As needed, these current inrush functions may also be used as part of a customer ATE program using any of the remote-control interface by sending the relevant SCPI Commands. For a summary of available remote control commands for these functions, refer to section 8.9.12, “Transient Inrush Current Mode Commands” starting on page 460.

3.8 Accessories Included (Ship Kit)

The following accessories are included with each AZX Series® AC power source. If one or more of these is missing upon incoming inspection of the product, please contact Pacific Power Source customer service. Note that AC input and AC output wiring, grid connection devices or external terminal blocks are NOT included with the power source or source cabinet systems.

Item	Quantity
Operation Manual in PDF Format	Available from PPS website
Combination AC Input Terminal, AC+DC Output Terminal and Voltage Sense Safety Cover (Plastic).	1
Certificate of Conformance	1

Table 3-3: Included Accessories

3.9 Remote Control Interfaces

Following remote control interfaces are standard:

Available Interfaces		Standard
USB Interface	Standard	✓
LAN Interface	Standard	✓
AUX I/O	Standard	✓
GPIB	Standard	✓

Table 3-4: Remote Control Interfaces

The HIL Interface can be added as an option can be ordered at time of original purchase.

Optional alternative interfaces supported on the AZX Series are:

Optional Interfaces		
ModBus TCP	Requires I/F adaptor	See section 14 on page 673
CAN / CAN-FD	Requires I/F adaptor	See section 15 on page 689

4 Technical Specifications

Technical specifications shown here apply at an ambient temperature of 25° C ± 5° C.

4.1 Single Cabinet Models

Three and Two (split) Phase Modes

MODEL	No. Outputs	Rated Power	Voltage Ranges		Current / Phs	Voltage Range		No. Cabs
			AC			DC		
3300AZX	3 Phase	30 kW	225 / 440 Vac		90 / 45 A	335 / 650 Vdc		1
	Split Phase	30 kW	225 / 440 Vac		117 / 68 A	335 / 650 Vdc		1
3450AZX	3 Phase	45 kW	225 / 440 Vac		110 / 65 A	335 / 650 Vdc		1
	Split Phase	33 kW	225 / 440 Vac		125 / 72 A	335 / 650 Vdc		1
3550AZX	3 Phase	55 kW	225 / 440 Vac		130 / 75 A	335 / 650 Vdc		1
	Split Phase	36.7 kW	225 / 440 Vac		130 / 75 A	335 / 650 Vdc		1

Single Phase Mode

MODEL	No. Outputs	Rated Power	Voltage Ranges		Current / Phs	Voltage Range		No. Cabs
			AC			DC		
3300AZX	1 Phase	30 kW	225 / 440 Vac		270 / 135 A	335 / 650 Vdc		1
3450AZX	1 Phase	45 kW	225 / 440 Vac		330 / 195 A	335 / 650 Vdc		1
3550AZX	1 Phase	55 kW	225 / 440 Vac		390 / 225 A	335 / 650 Vdc		1

4.2 Multiple Cabinet Models

Multi cabinet model configurations consist of a single master cabinet and one or more slave cabinets connected through a high-speed parallel bus. Each cabinet requires its own three-phase AC input and must be turned on at the front panel using its individual circuit breaker. This avoids massive inrush current at power up of the system as each cabinet can be turned on one at a time.

Three and Two (split) Phase Mode

MODEL	No. Outputs	Rated Power	Voltage Ranges		Current / Phs	Voltage Range		No. Cabs
			AC			DC		
3600AZX	3 Phase	60 kW	225 / 440 Vac		180 / 90 A	335 / 650 Vdc		2
	Split Phase	60 kW	225 / 440 Vac		234 / 136 A	335 / 650 Vdc		1
3900AZX	3 Phase	90 kW	225 / 440 Vac		220 / 130 A	335 / 650 Vdc		2
		66 kW	225 / 440 Vac		240 / 140 A	335 / 650 Vdc		1
31100AZX	3 Phase	110 kW	225 / 440 Vac		260 / 150 A	335 / 650 Vdc		200 / 100 A
	Split Phase	73.3 kW						
31650AZX	3 Phase	165 kW	225 / 440 Vac		390 / 225 A	335 / 650 Vdc		300 / 150 A
	Split Phase	110 kW						
32200AZX	3 Phase	220 kW	225 / 440 Vac		520 / 300 A	335 / 650 Vdc		4

MODEL	No.	Rated	Voltage Ranges	Current / Phs	Voltage Range	Curr./Output	No.
	Split Phase	147 kW					

4.3 AC Output Mode

AC OUTPUT	
Voltage	
Low Voltage AC Range	0 - 225 V L-N rms / 0 - 390 V L-L rms
High Voltage AC Range	0 - 440 V L-N rms / 0 - 760 V L-L rms
Programming Resolution	0.01 V
Accuracy	±0.1% F.S.(CSC mode)
Waveforms	Sine wave, Clipped, Square, Triangle, Saw tooth, Arbitrary Max. No. of waveforms: 200
DC Offset	< 20 mV
Harmonic Distortion ¹ (Vthd) (Full, Resistive Load)	< 100 Hz: < 0.2% 100~1000 Hz: < 0.2% +0.125%/100Hz See V THD Chart at bottom of page
Output Noise (DC – 300 kHz)	
Low Voltage AC Range	< 250 mV rms
High Voltage AC Range	< 500 mV rms
Load Regulation	± 0.02% (CSC Mode on)
Line Regulation	± 0.1% for 10% Line Change
External Voltage Sense	External Sense, max. voltage drop 5% FS.
Voltage Slew Rate	12.0 V/μs max. for 10%-90% or 90%-10% of Full scale voltage
Isolation	
Any Output Terminal to Chassis	1000 V _{peak} / 1000 V _{DC}
Frequency	
Range	15.00 – 1000.0 Hz (Normal Mode) 1.00 – 15.00 Hz (Very Low Frequency mode [VLF] – see Figure 4-10) 1000 – 3000 Hz (Extended High Frequency Range – see Figure 4-11)
Programming Resolution ²	0.01 Hz
Accuracy	± 0.005% / 50 ppm
Current Limit	
Range ³	See Figure 4-2 and Figure 4-3. Values shown are supported for any period of time.
Maximum AC Peak Current	Low Voltage Range: 360Apk / phase High Voltage Range: 180Apk / phase
Programming Resolution	0.01 A rms
Accuracy	± 0.25% F.S.
Modes	Constant Current Mode or Output Trip
Response Time	RMS Current Limit: Programmable, 100 msec min. Peak Current: 10 μsec
Phase Angles (3 Phase Models)	
Phase Offsets ⁴	A = 0°, B = 240°, C = 120° (programmable)
Programming Resolution	0.1°
Accuracy	± 0.35° ± 0.1° in Phase Regulation Mode
Phase Rotation in 3-Phs mode (default)	A, B, C = 0°, 120°, 240° Consistent with Pacific Power UPC Controller products. Phase rotation default phase rotation selectable using “reversed phase polarity” setting if desired.
Programmable Impedance (Real-Time Mode)	
Resistance (R)	-10.000 to +10.000 Ohm

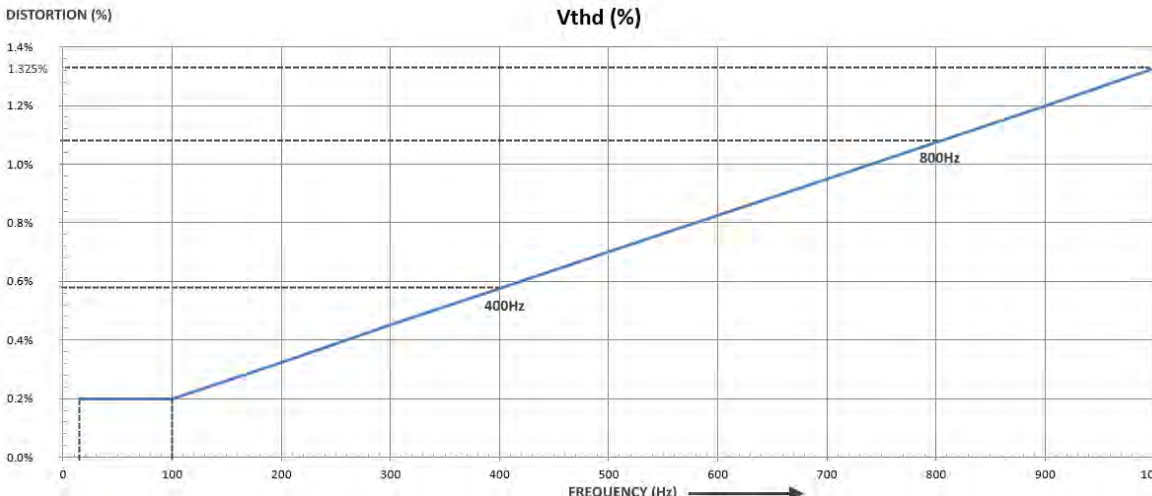
AC OUTPUT	
Inductance (L)	0 to 2 mH
Programmable Impedance (RMS Mode)	
Resistance (R)	-10.000 to +10.000 Ohm
Inductance (L)	0 to 2 mH
Note 1: Refer to Figure 4-1, "Output Voltage distortion into full R Load as a function of Frequency" on next page.	
Note 2: FREQUENCY PROGRAM RESOLUTION FOR EXPORT MODELS (-E): Per U.S.A. Bureau of Industry and Security, ECCN 3A225, frequency control is limited to no better than 0.2% at frequencies of 600 Hz. or more for unrestricted export products. To meet that requirement, frequency programming on all AZX--E models has three resolution ranges, which round the frequency to the nearest increment, as defined in the table below.	
Frequency Resolution for Export Models	
<u>Range</u>	<u>Resolution</u>
1.00 - 99.99 Hz	0.01 Hz
100-599.9 Hz	0.1 Hz
600 - 999 Hz	2.0 Hz
1000	5.0 Hz
Note 3: Refer to AC Mode Voltage / Current rating charts Figure 4-2 through Figure 4-5	
Note 4: Actual output phase angles may be slightly different from programmed values for highly unbalanced three phase load conditions, in particular at high frequency due to amplifier phase shift differences.	
	
<p>Figure 4-1: Output Voltage distortion into full R Load as a function of Frequency</p>	

4.3.1 Programmable Output Impedance Ranges by Phase Mode

The programmable range for output impedance varies based on model, phase mode setting. The table below summarizes the available ranges as function of these. Ranges are the same for Real-Time Mode and RMS Mode.

Models	Phase Mode	± Limits	0 - Max Limits
		R +/- Ohms	L + mH
3300AZX, 3450AZX, 3550AZX	Three Phase (FORM3), FORM4 & FORM5	-10.00 ~ + 10.00	0 ~ 2.00
	Split Phase	-20.00 ~ + 20.00	0 ~ 4.00
	Single Phase	-10.00 ~ + 10.00	0 ~ 2.00

Table 4-1: Programmable Impedance Ranges by Phase mode

4.3.2 Programmable Impedance operation

Considerations when using Programmable Impedance functions.

In order to maximize the setting range for prog-Z, the AC Source controller gradually reduces the bandwidth of the feedback loop. This means that higher impedances (resistance and/or inductance) are slower to react.

At frequency settings of 50~60Hz, this works well in over the entire range. At higher frequencies the impedance accuracy will decrease, especially the inductive part (L).

Also, setting a high resistance (>1ohm) R impedance when the AC source is driving a highly capacitive load can result in instability.

The user should verify the prog-Z stability with the load before using it. ***Tight protection settings (peak and RMS current) are recommended to protect the power source and the load in case the system oscillates.***

Also, when using a negative impedance setting, the AC source can easily become unstable, depending on the load impedance, because negative impedance implies positive feedback which has a higher likelihood of causing instability.

4.3.3 AC Voltage and Current Output Charts

AC VOLTAGE RANGES – 3300AZX Models

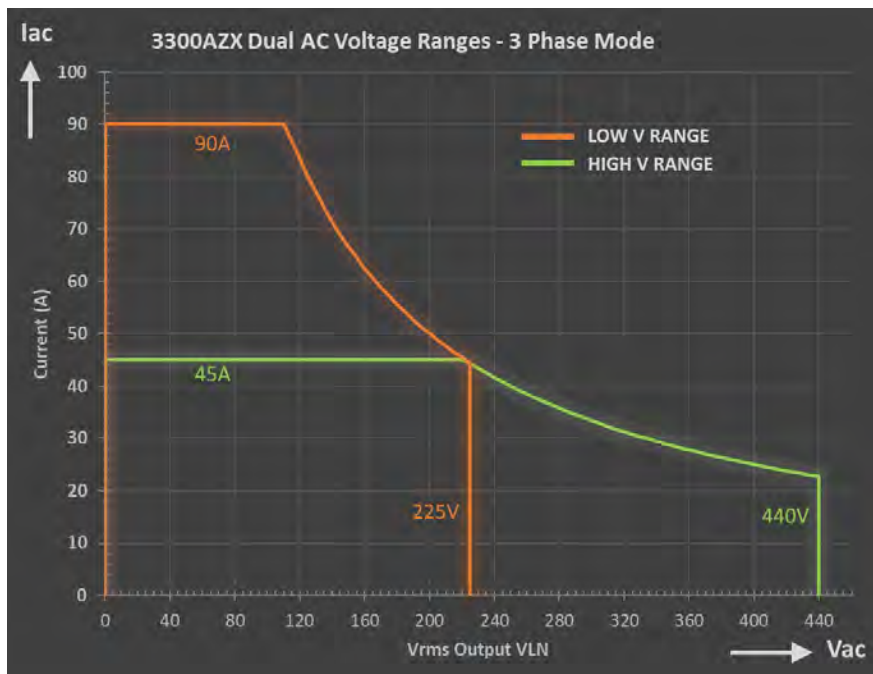

Figure 4-2: AC Mode Voltage/Current range, 3300AZX Models - Three phase mode.

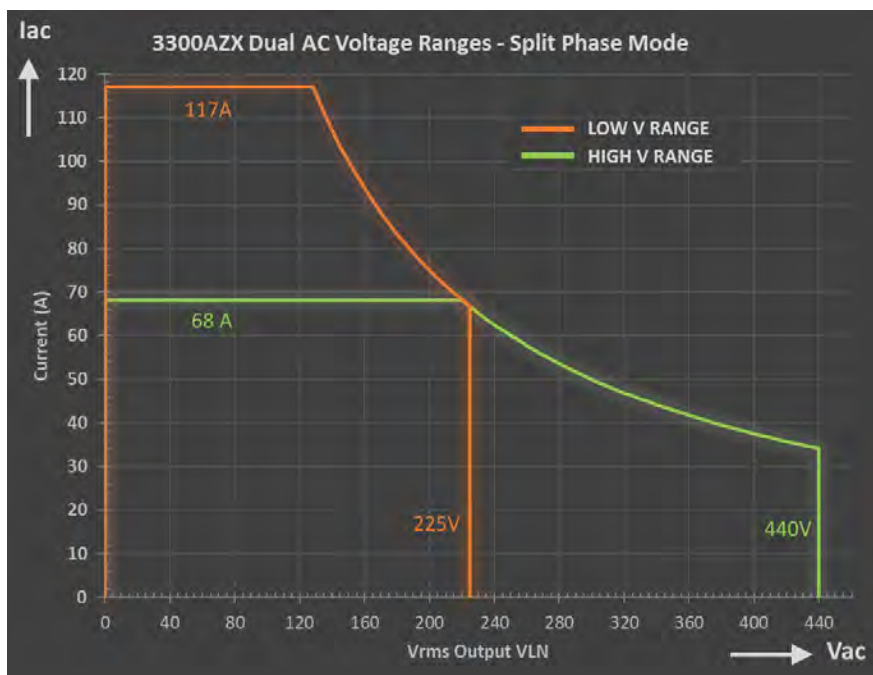

Figure 4-3: AC Mode Voltage/Current range, 3300AZX Models – Split phase mode.

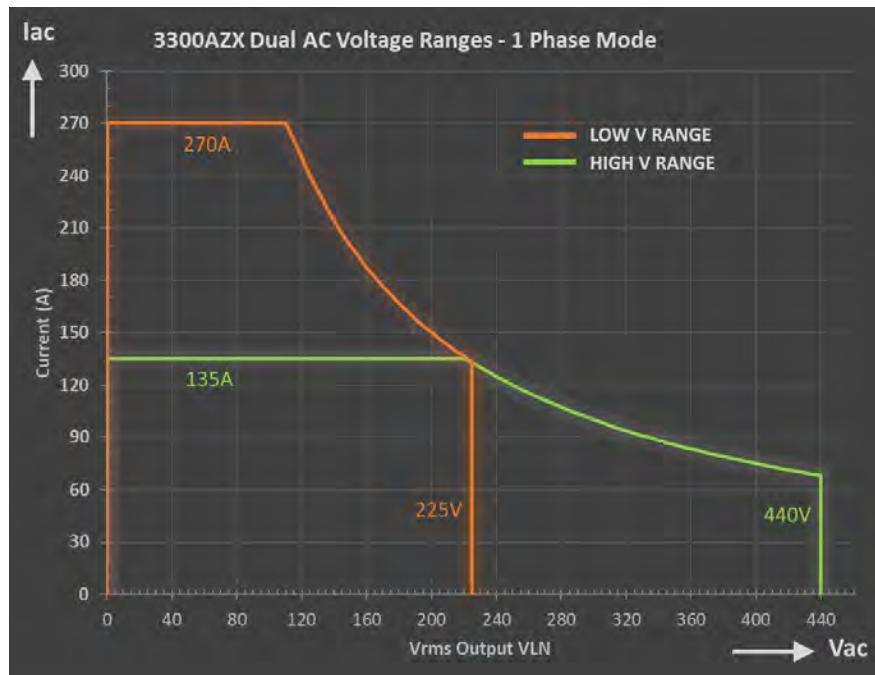

Figure 4-4: AC Mode Voltage/Current range, 3300AZX Models – Single phase mode.

AC VOLTAGE RANGES – 3450AZX Models

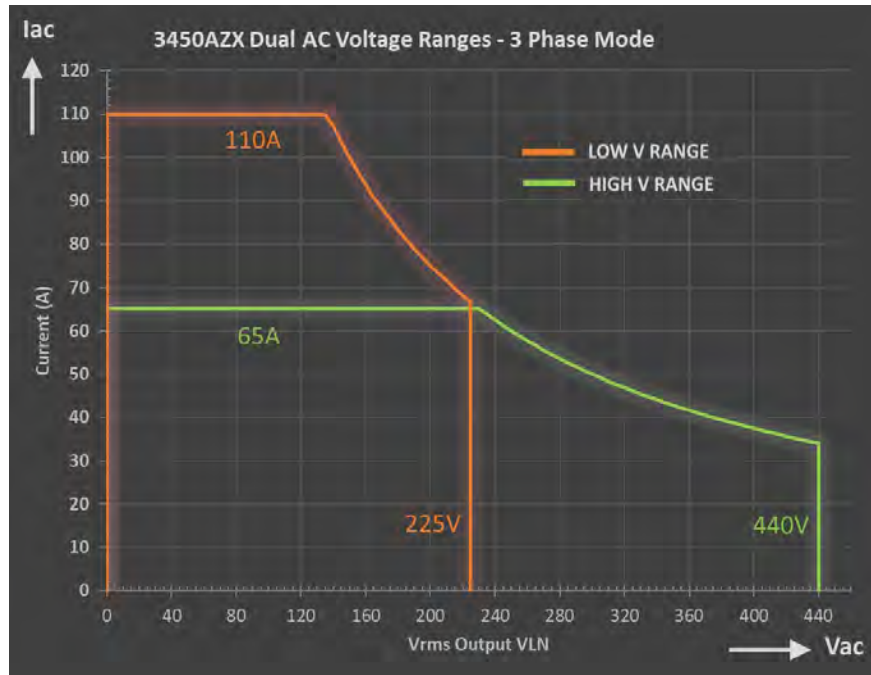

Figure 4-5: AC Mode Voltage/Current range, 3450AZX Models – Three phase mode.

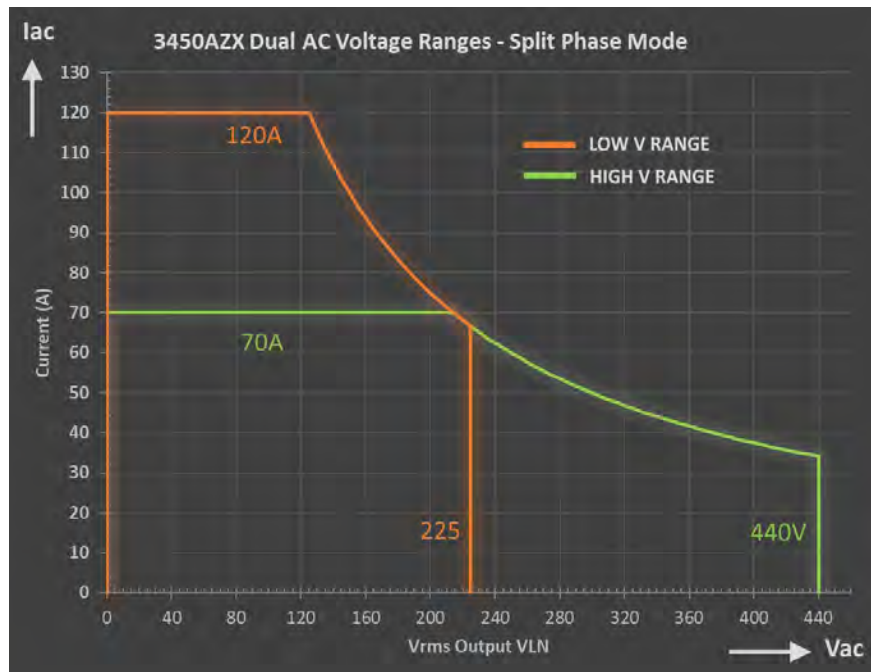

Figure 4-6: AC Mode Voltage/Current range, 3450AZX Models – Split phase mode.

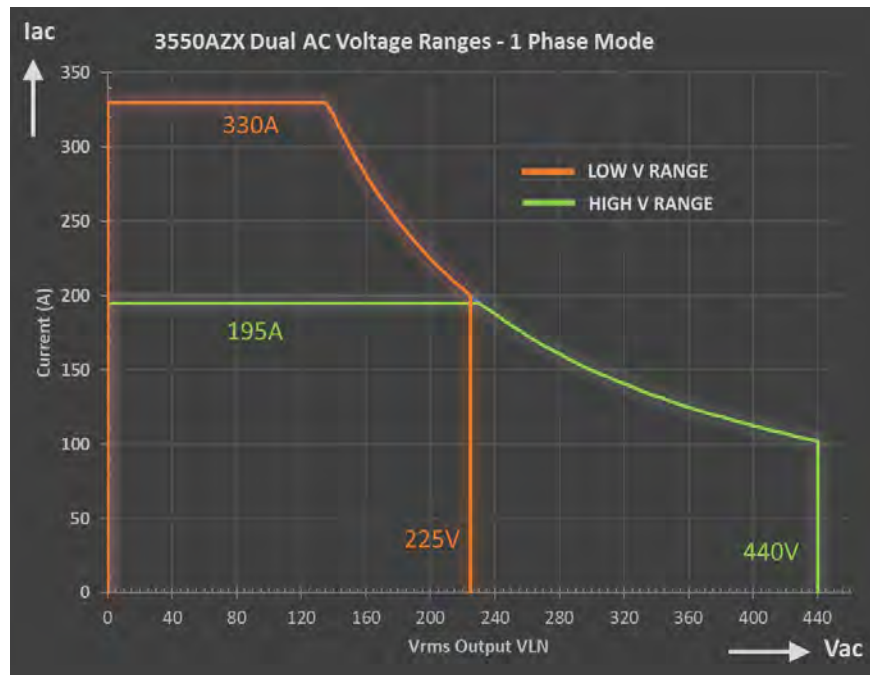

Figure 4-7: AC Mode Voltage/Current range, 3450AZX Models – Single phase mode.

AC VOLTAGE RANGES – 3550AZX Models

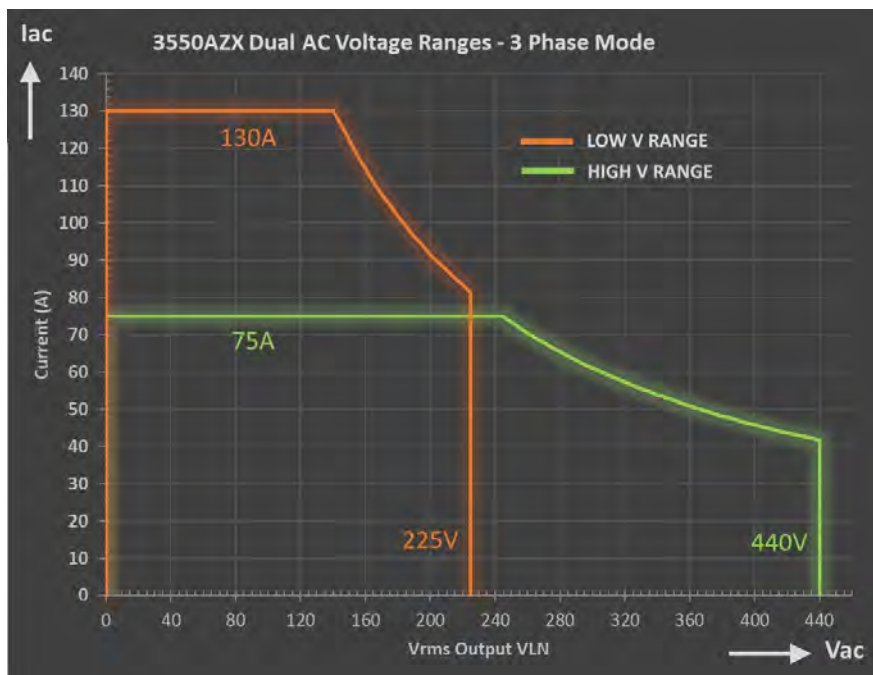

Figure 4-8: AC Mode Voltage/Current range, 3550AZX Models - Three & Split-phase mode.

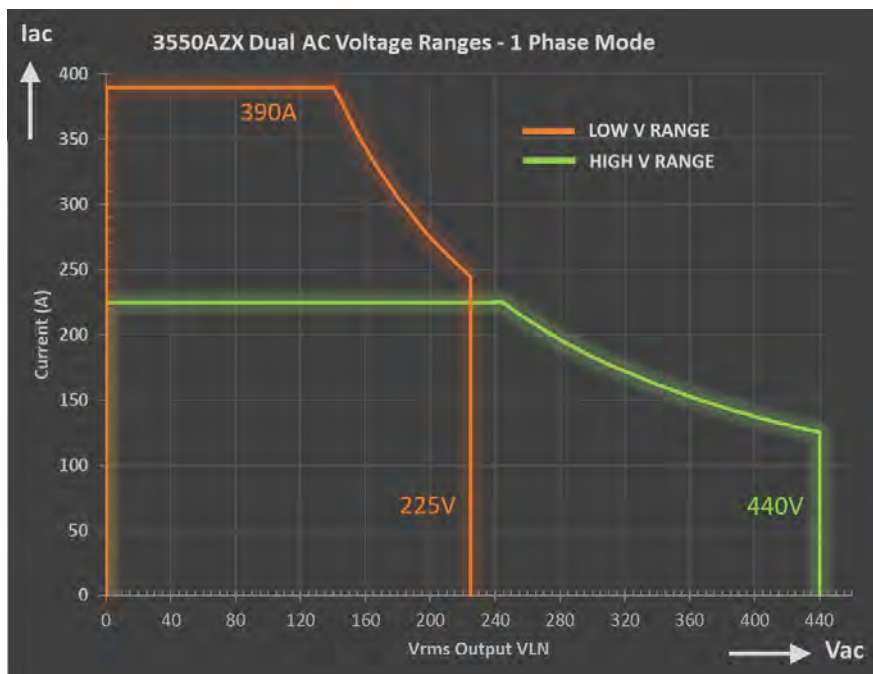

Figure 4-9: AC Mode Voltage/Current range, 3550AZX Models – Single phase mode.

LOW FREQUENCY POWER DERATING CHARTS AZX SERIES

At frequencies below 45Hz, the output power and current of the AZX Series power sources derates in a linear fashion.

The derating formulas for models 45kW or higher are:

$$\text{CURRENT_RMS_LOW_RANGE} = 100 \text{ Arms} * \text{FACTOR} * \text{PARALLEL_UNITS} + ((\text{FREQ} - 1)/14) (\text{NOMINAL_CURRENT_LOW_RANGE} - 100 \text{ Arms})$$

$$\text{CURRENT_RMS_HIGH_RANGE} = 50 \text{ Arms} * \text{FACTOR} * \text{PARALLEL_UNITS} + ((\text{FREQ} - 1)/14) (\text{NOMINAL_CURRENT_HIGH_RANGE} - 50 \text{ Arms})$$

$$\text{POWER} = 35.35 \text{ kW} * \text{PARALLEL_UNITS} + ((\text{FREQ} - 1)/14) (\text{NOMINAL_POWER} - 35.35 \text{ kW})$$

$$\text{KVA} = 35.35 \text{ kVA} * \text{PARALLEL_UNITS} + ((\text{FREQ} - 1)/14) (\text{NOMINAL_POWER} - 35.35 \text{ kVA})$$

There is no derating for low frequency on the 3300AZX 30kW models. This is represented in the chart below.

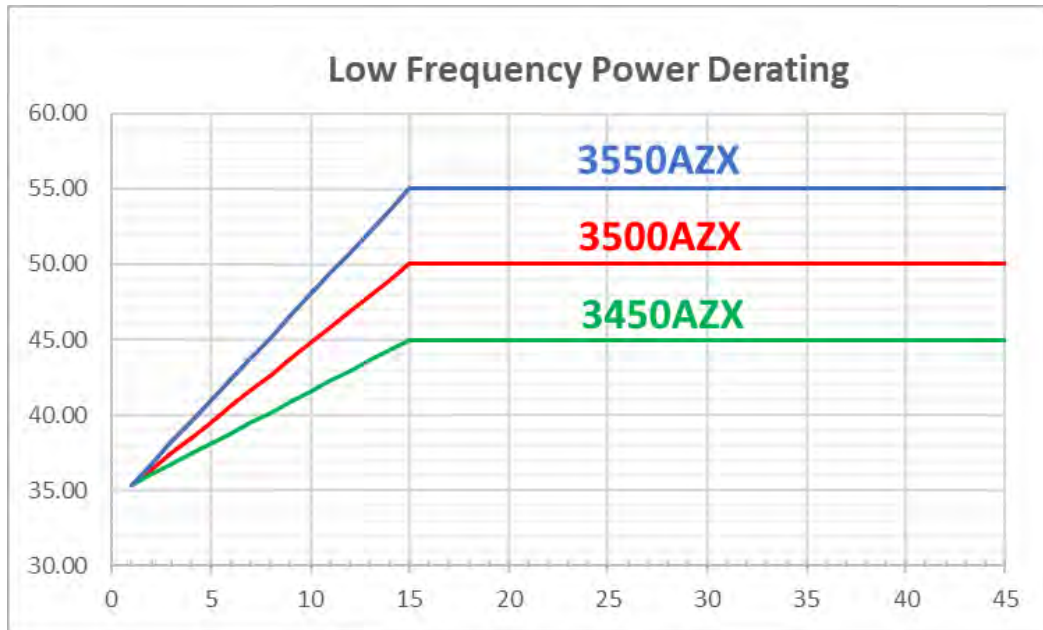

Figure 4-10: AZX Series Low Frequency (< 45 Hz) derating chart

HIGH FREQUENCY POWER DERATING AZX SERIES

At frequencies above 1000Hz, the output power, voltage and current of the AZX Series power sources derates in a linear fashion. **Note** that extended high frequency operation may require a firmware update.

The power derating for extended high frequency operation is linear from 1000 Hz to the maximum of 3000 Hz as follows:

Model	Phases	High Voltage Range Max	Low Voltage Range Max
3550AFX & 3500AZX	3 or 2	@ 2000Hz, 60Arms / 380 Vrms	@ 2000Hz, 90Arms / 210 Vrms
		@ 3000Hz, 50Arms / 250 Vrm	@ 3000Hz, 75Arms / 140 Vrms
	Single	Current is times 3, same Vmax	Current is times 3, same Vmax
3450AZX	3 or 2	@ 2000Hz, 60Arms / 380 Vrms	@ 2000Hz, 90Arms / 210 Vrms
		@ 3000Hz, 50Arms / 250 Vrm	@ 3000Hz, 75Arms / 140 Vrms
	Single	Current is times 3, same Vmax	Current is times 3, same Vmax
3300AZX	3 or 2	@ 2000Hz, 45Arms / 380 Vrms	@ 2000Hz, 90Arms / 210 Vrms
		@ 3000Hz, 45Arms / 250 Vrms	@ 3000Hz, 75Arms / 140 Vrms
	Single	Current is times 3, same Vmax	Current is times 3, same Vmax

Note: There is no power derating for extended high frequency on the 3300AZX 30kW models.

4.3.4 Output Capacitance

The output capacitance of the AZX unit varies as a function of operating mode (Voltage Source, Current Source or Load and high or low voltage range). This capacitance can interact with a unit under test connected to the output (or input in Load mode) of the unit. These capacitor component can only absorb so much power so care must be taken not to over-stress them. The AZX will measure total ripple and power consumption and shut down the unit if power dissipation in these capacitors gets too high. However, ripple currents above 100 kHz are outside of the AZX measurement range so will not be considered.

Depending on the mode and range, the number of capacitors at the output changes to the following:

- Voltage Mode: 5 capacitors (in parallel) per power module.
 - High range: 2 power modules in series, 5 capacitors are connected in series with 5 capacitors, total output capacitance is 5.5uF. The maximum current is 30Arms.
 - Low range: 2 power modules in parallel, 10 capacitors are connected in parallel, total output capacitance is 22uF. The maximum current is 60Arms.
- Current Mode or Load Mode: 1 capacitor per power module.
 - High range: 2 power modules in series, 1 capacitor in series with 1 capacitor, total output capacitance is 1.1uF. The maximum current is 6Arms.

- Low range: 2 power modules in parallel, 2 capacitors are connected in parallel, total output capacitance is 4.4uF. The maximum current is 12Arms.

Operating Mode	High Range		Low Range	
	Capacitance	Max Ripple	Capacitance	Max Ripple
Voltage Source	5.5 μ F	30 Arms	22 μ F	60 Arms
Current Source / Load	1.1 μ F	6 Arms	4.4 μ F	12 Arms

The table below shows typical reactive current at 230Vac / Hz and 120Vac / 60Hz for the available capacitance configurations on a single AZX unit in three or split phase mode that are available.

Reactive current per channel						
Voltage RMS [Vrms]	Frequency [Hz]	Capacitance [μ F]	Less Capacitance [μ F]	VRange Mode	Current RMS [Arms]	Current RMS [Arms]
230.00	50.00	22.00	4.40	Low	1.590	0.318
230.00	50.00	5.50	1.10	High	0.397	0.079
120.00	60.00	22.00	4.40	Low	0.995	0.199
120.00	60.00	5.50	1.10	High	0.249	0.050

Note: For single phase mode, multiply current by 3. For parallel AZX units, multiply current by the number of units in parallel

4.4 DC Output Mode

DC OUTPUT	
Voltage	
Low Voltage DC Range	0 – 335 Vdc
High Voltage DC Range	0 – 650 Vdc
	Refer to Figure 4-4 and Figure 4-5 for Voltage vs Current Constant Power Mode profile for 3 phase and 1 phase modes
Programming Resolution	0.01 V
Accuracy	\pm 0.1% F.S
Noise & Ripple	
Low Voltage Range	< 250 mV rms
High Voltage Range	< 500 mV rms
Load Regulation	\pm 0.02% (CSC Mode on)
Line Regulation	\pm 0.1% for 10% Line Change
External Voltage Sense	External Sense, max. voltage drop 5% FS.
Voltage Slew Rate	12.0 V/ μ s max. for 10%-90% or 90%-10% of Full scale voltage
Isolation- Output to Chassis	1000 Vdc
Current Limit	
Range	See Figure 4-7 and Figure 4-8
Programming Resolution	0.01 Adc
Accuracy	\pm 0.25 % F.S.
Modes	Constant Current Mode or Output Trip

4.4.1 DC Voltage and Output Current Charts

DC VOLTAGE RANGES – 3300AZX Models

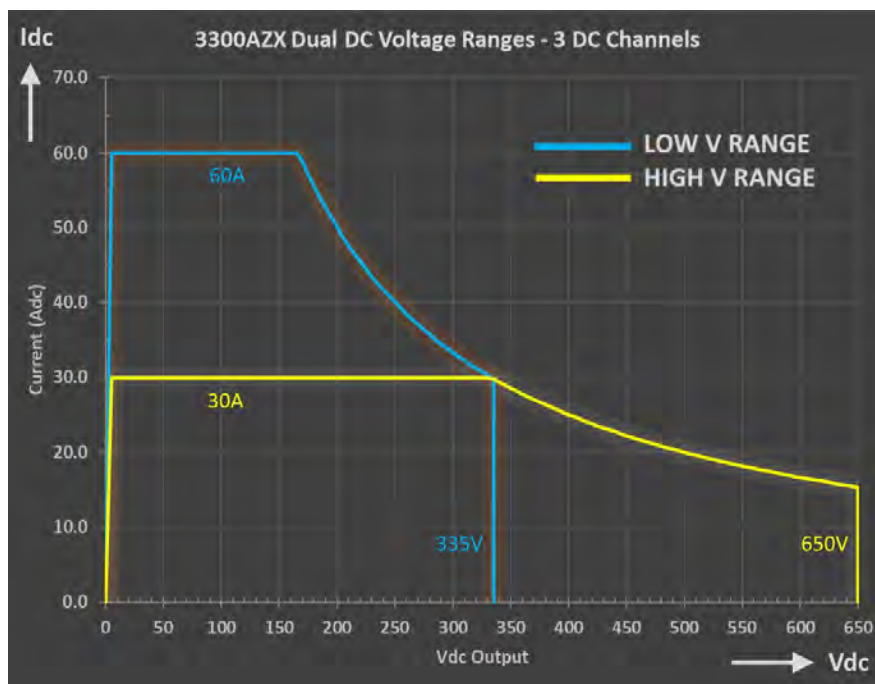

Figure 4-11: DC Mode Voltage/Current range, 3300AZX Models- Three Channel mode.

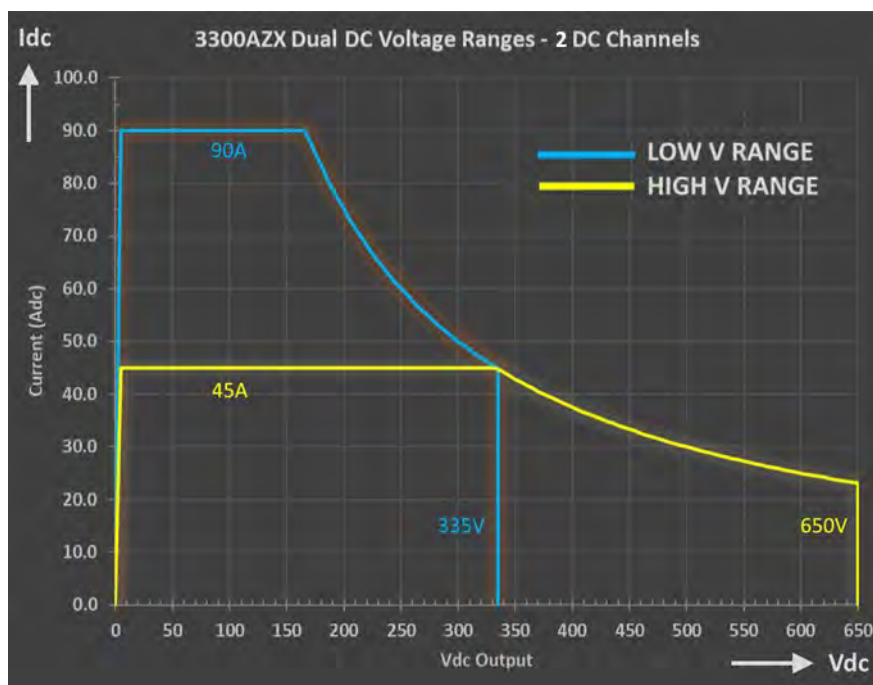

Figure 4-12: DC Mode Voltage/Current range, 3300AZX Models – Dual Channel mode.

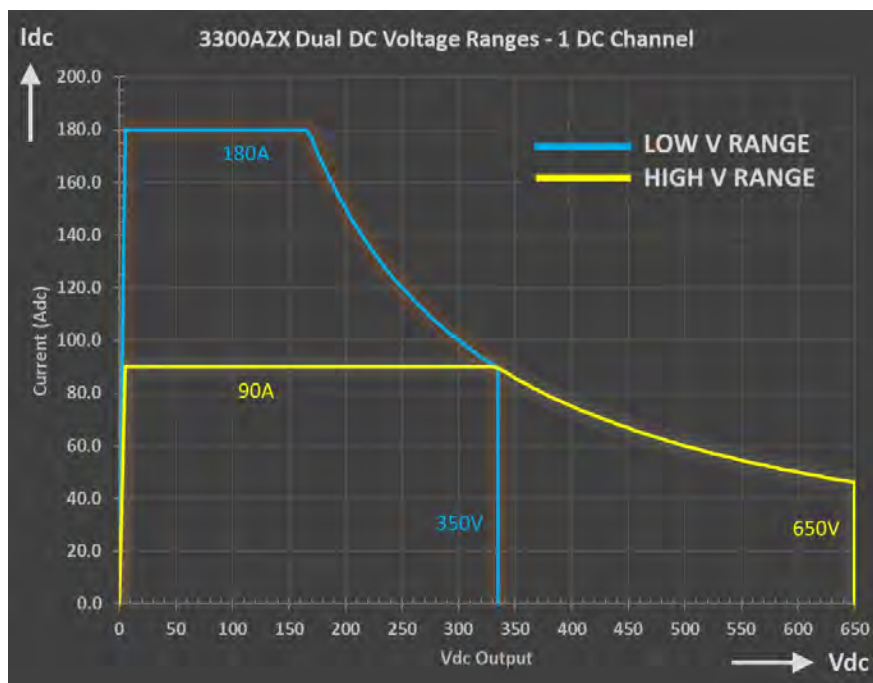

Figure 4-13: DC Mode Voltage/Current range, 3300AZX Models – Single Channel mode.

DC VOLTAGE RANGES – 3450AZX Models

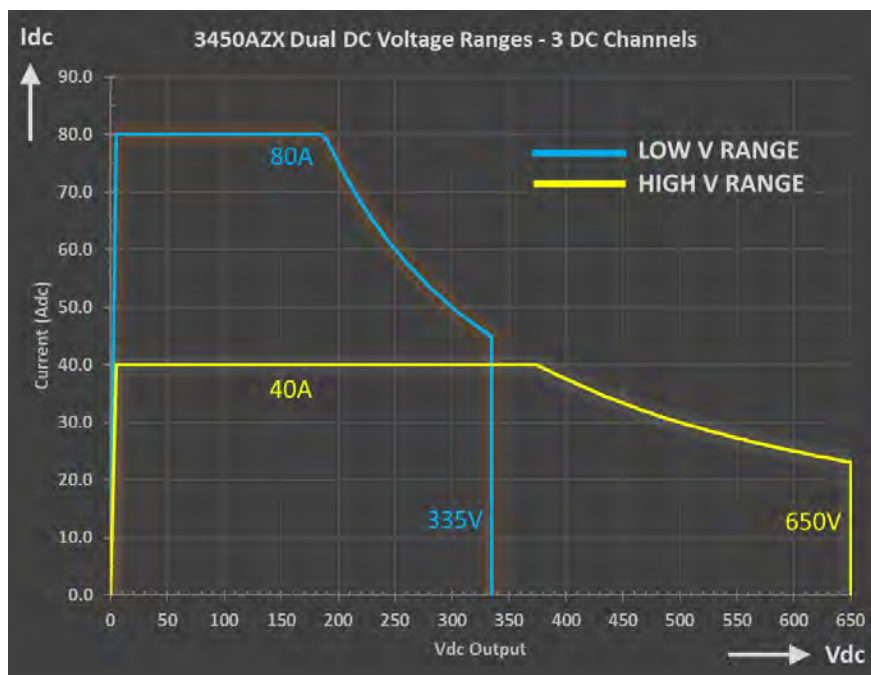

Figure 4-14: DC Mode Voltage/Current range, 3450AZX Models- Three Channel mode.

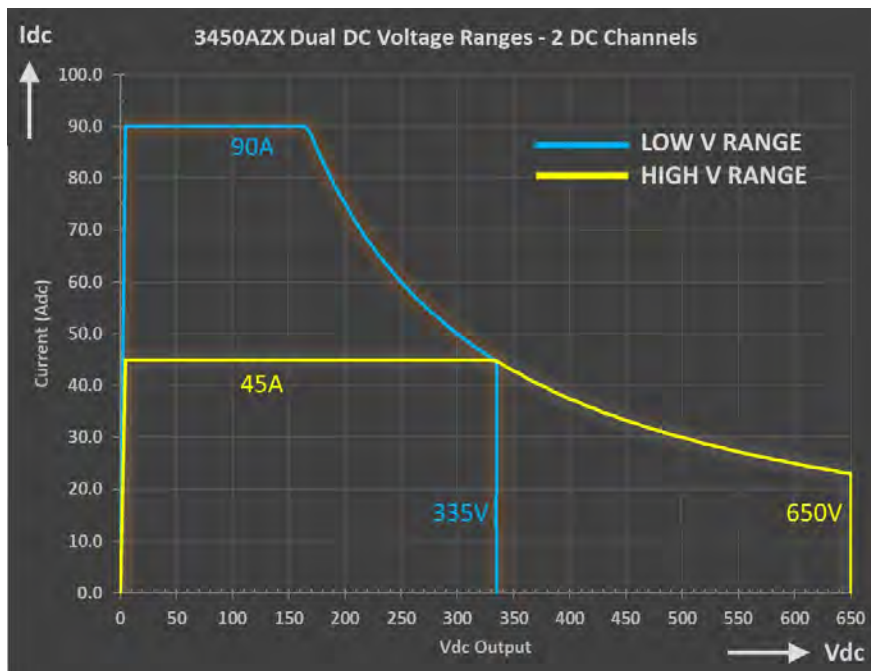

Figure 4-15: DC Mode Voltage/Current range, 3450AZX Models- Dual Channel mode.

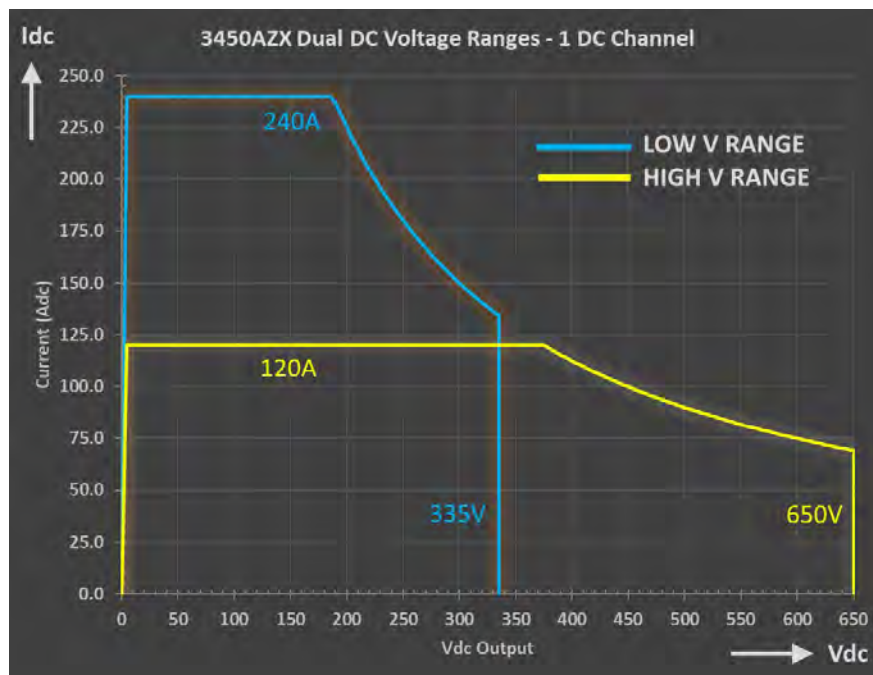

Figure 4-16: DC Mode Voltage/Current range, 3450AZX Models – Single Channel mode.

DC VOLTAGE RANGES – 3550AZX Models

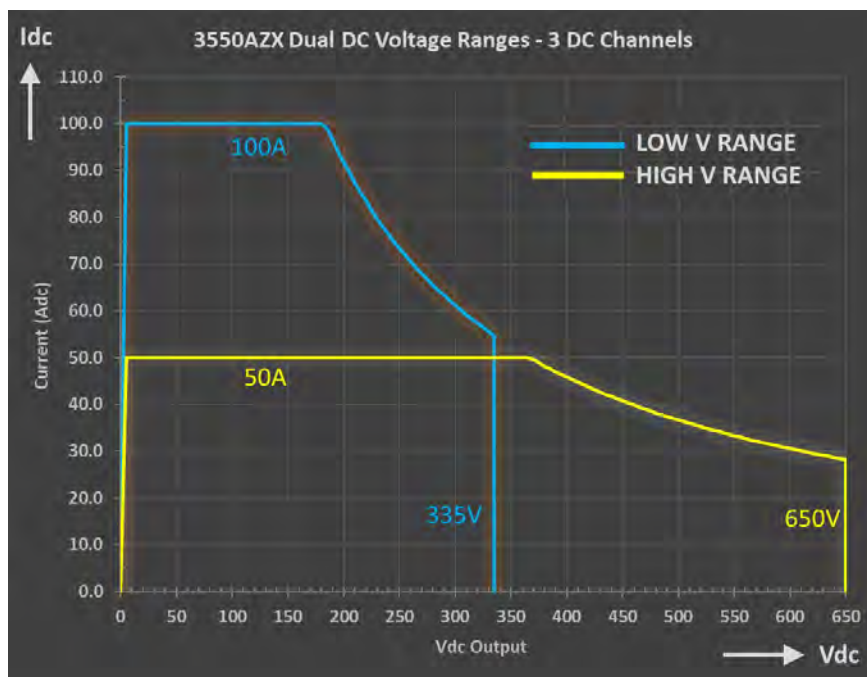

Figure 4-17: DC Mode Voltage/Current range, 3550AZX Models- Three & Two Channel mode.

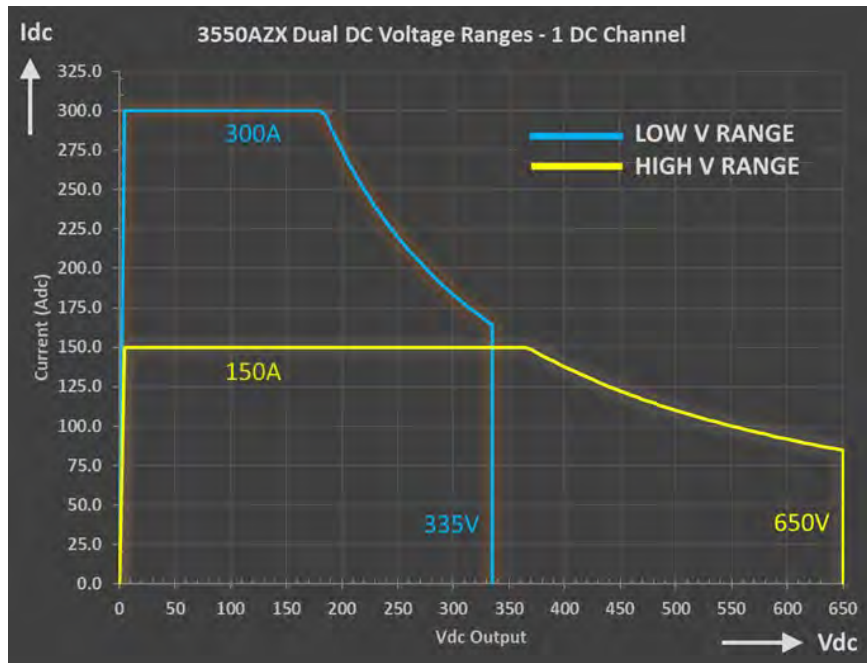

Figure 4-18: DC Mode Voltage/Current range, 3550AZX Models – Single Channel mode.

4.5 Protection Modes

PROTECTION	
Protection Modes	RMS Current, DC Current, Peak Current, Peak Voltage, True Power, Apparent Power, Internal Over Temperature, Advanced protection modes for regenerative devices
OVP Range	0 - 105% Vmax
AC Input Voltage	Over and Under Voltage

4.6 Metering

MEASUREMENTS		Per AZX Chassis
AC Voltage (Vrms)		
Ranges		0 – 440 V _{LN} / 0-760 V _{LL}
Resolution		FP: 0.01 V / Bus: 0.001 V
Accuracy		± 0.1% F.S.
Frequency (Hz)		
Fundamental Range		1 Hz - 1000 Hz
Resolution		FP: 0.01 Hz / Bus: 0.001 Hz
Accuracy		± 0.1% Rdg
AC Current (Arms)		
Current Meas. Ranges ¹		High 0 - ±130 Arms / Low: 0 - ±65 Arms
Resolution		FP: 0.01 A / Bus: 0.001 A
Accuracy ²		± (0.25% + f (kHz) * 0.25%) F.S.
Current Crest Factor		
Range		1.00 - 10.00
Resolution		FP: 0.01 / Bus: 0.001
Accuracy ³		± 2.0% F.S.
AC or DC Power (W)		
Range		0 – 55 kW
Resolution		FP: 0.01 W / Bus: 0.0001 W
Accuracy ³		± 0.75 % F.S.
Apparent Power (VA)		
Range		0 – 55 kVA
Resolution		FP: 0.01 VA / Bus: 0.0001 VA
Accuracy ³		± 0.75 % F.S.
Power Factor		
Range ³		0.00 - 1.00
Resolution		PF: 0.01 / Bus: 0.001
DC Voltage (Vdc)		
Range ⁴		0 – 650 Vdc
Resolution		FP: 0.01 V / Bus: 0.001 V
Accuracy		± 0.1% F.S.
DC Current (Adc)		
Range ¹		High: 0 – ±100 Adc / Low: 0 - ±50 Adc
Resolution		FP: 0.01 A / Bus: 0.001 A
Accuracy ²		± 0.25% F.S.

Note 1: Plus sign indicates sourcing current, minus sign indicates sinking current.

Note 2: Measurement Accuracies for Current and Power apply for load currents of 2.0 Arms or more.

Note 3: For Current levels above 1.0 Arms

4.7 Other Measurements

Measurements	
Waveform Capture	
Time Domain	1024 samples/period
Parameters	$V_{LN-A}, V_{LN-B}, V_{LN-C}, V_{LLAB}, V_{LLAC}, V_{LLBC}, IA, IB, IC$
Samples/cycle	1024 (512 in UPC Compatibility mode)
Record Length	1 Period of fundamental Frequency
Bandwidth	100 kHz @ 500 kps
Harmonics Measurements	
Parameters	$V_{LN-A}, V_{LN-B}, V_{LN-C}, V_{LLAB}, V_{LLAC}, V_{LLBC}, IA, IB, IC$
Harmonics Range	H1 ~ H50
Accuracy – Amplitude	± 1.0 % of RMS Reading
Phase Angle Range	0 ~ 359.9
Accuracy - Phase Angle	2 μsec
Bandwidth	100 kHz @ 500 kps
Display Modes	Table format, Graph Format

4.8 Transients

Transients	
Programming	
No. of Entries	200 Steps, 400 Segments
Parameters	Voltage, Frequency, Phase B & C, Ramp Time, Dwell Time
Dwell Time Range	0.0 – 10,000,000.0 msec
Ramp Time Range	0.2 – 10,000,000.0 msec
Time Resolution	100 μsec (0.0001 sec)
Edit Modes	Add at End, Insert Before, Delete
Execution	
Run Control	Run from Step # to Step # Run, Step, Restart, Stop
Program Storage	
Non-Volatile	100, Programs + Transients

4.9 AC Input

AC INPUT			
Mains Voltage Form	4 Wire, L1, L2, L3 and PE		
Frequency	47 - 63 Hz		
400V Input Setting	3300AZX	3450AZX	3550AZX
Input Voltage Range	380V ~ 400Vac ± 10%		
Max. Output Power Rating	30 kW	45 kW	55 kW
Nominal Line Current @380Vac	54 Arms	80 Arms	100 Arms
Max. Line Current @ Low Line 342V	60 Arms	90 Arms	110 Arms
Peak Inrush Current	< 130 Apk	< 150 Apk	< 150 Apk
Input Power Factor	> 0.99 @ Full Load		
AC Input Current - THDi	< 2 %		
Efficiency	89%	90%	90%
480V Input Setting	3300AZX	3450AZX	3550AZX
Input Voltage Range	480Vac ± 10%		
Max. Output Power Rating	30 kW	45 kW	55 kW
Nominal Line Current	43 Arms	72 Arms	80 Arms
Max. Line Current @ Low Line 432V	47 Arms	80 Arms	88 Arms
Peak Inrush Current	< 110 Apk	< 120 Apk	< 120 Apk
Input Power Factor	> 0.99 @ Full Load		
AC Input Current - THDi	< 2 %		
Efficiency	89%	90%	90%
Standby Mode Power Consumption (typical)			
	The power source has a Standby Mode which can be enabled when the output relay is in the OFF state. In this mode, all fans and power stages are turned off to reduce power consumption. Only the AC input transformer remains energized. Typical power consumption in each mode is as follows:		
Output State ON, no load connected:	1100 Watt		
Output State Off:	800 Watt / 1500 VA		
Output State Off & Standby Mode:	500 Watt		

NOTE: For models consisting of multiple chassis, power input ratings apply to each chassis.

4.10 Dimensions & Weight

MECHANICAL	
Dimensions	
H x W x D (Height includes Casters)	59.8" x 24.0" x 31.9" 1520 x 610 x 810 mm
Shipping H x W x D	71" x 32" x 44" 1800 x 810 x 1120 mm
Weight	
Net	517 Kg / 1140 lbs.
Shipping	592 Kg / 1305 lbs.

NOTE: For models consisting of multiple chassis, multiply weight and height by the number of chassis.

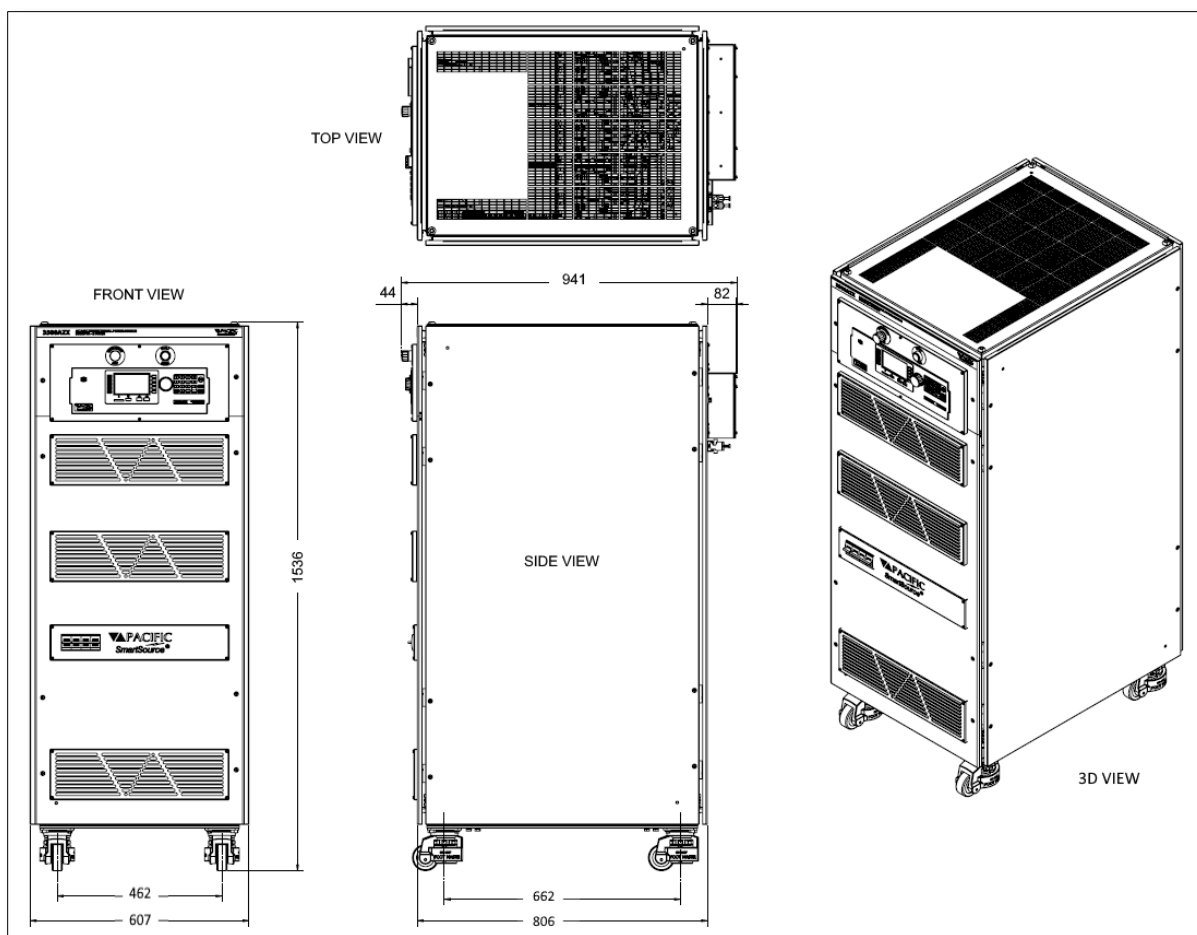

Figure 4-19: Cabinet Dimension Drawing AZX Series® 30kVA & 50kVA Model



4.11 Environmental

ENVIRONMENTAL	
Cooling	Variable speed fan cooled, front and bottom intake, top exhaust. User Serviceable Air Filters on front panel
Audible Noise, Single Cabinet AZX	No Load: 63.4 dBA typical Full Load: 73.3 dBA typical <i>Measured at front of unit, 1 m / 3.3 Ft distance, 1.5 m / 5 Ft from floor</i>
Operating Temperature	0 to 40 °C / 32 to 104 °F
Storage Temperature	-20 to 70 °C / -4 to 158 °F
Humidity	< 80%, non-condensing for temperatures up to 40 °C
Altitude (max.)	2000 m / 6560 feet
Equipment ingress protection rating per IEC 60529	IP20

4.12 Safety & Regulatory

SAFETY & REGULATORY	
Safety Standard	EN 61010-1:2010 (Edition 3)
EMC Emissions	EN 55011:2009+A1:2010
EMC Immunity	EN 6100-4-2, -3, -4, -5, -6, -8, -11
Product Category	EN61326-1:2010 (Measurement, Laboratory and Control Equipment)
Approvals	CE Mark

4.13 Digital Interfaces

USB	
USB Standard	USB 2
USB Class	
Front Panel	Type A USB Host (2)
Connector	Type A, standard
Rear Panel	Type A USB Host (1) Type B USB Device (1)
Connector Types	<div style="display: flex; justify-content: center; align-items: center; gap: 20px;"> <div style="text-align: center;"> <p>A</p>  </div> <div style="text-align: center;"> <p>B</p>  </div> </div>

RS232	
Baud rate:	9600, 14400, 19200, 38400, 57600, 62500, 115200
Parity:	O = Odd = uneven parity E = Even = even parity N = None = no parity bit
Number of data bits:	7 or 8
Number of stop bits:	1 or 2
Handshake:	Xon/Xoff
Signal Levels:	
Inputs (RxD)	Maximum input voltage: ± 25 V Input Impedance: 5 kΩ typical Switching thresholds: $V_H < -3 V, V_L > +3 V$
Outputs (TxD)	Output voltage (at $R_{LOAD} > 3 k\Omega$): min ± 5 V, typical ± 5.4 V Output Impedance: < 300Ω min., 10 MΩ typical in power off state Short circuit current: Typ. ± 35 mA typical

Ethernet (L)	
Protocol	Ethernet TCP/IP, 100Mb/1000Mb
Connector	RJ45
Webserver	Built-in
LXI Compliance	Core, version 1.4

GPIB	
IEEE Standard	IEEE488,1, IEEE488.2 (2003 incl., NI HS488) IEC 60488-1, IEC 60488-2 (2004)
IEEE Functions Supported	SH1, AH1, T6, L3, SR1, RL1, DC1, DT1
Connector	Amphenol 24 pin, Micro ribbon connector. Rear Panel Set screws: M3.5×0.6 metric threads.

Remote Inhibit	
Operation	Contact closure enables Output On/Off control Open circuit disables On/Off control
Modes	Disabled, Live or Latching (Configurable)
Connector	DB25, Rear Panel (See Auxiliary I/O)

4.14 Auxiliary I/O (Digital & Analog I/O)

The following technical specifications apply to the Auxiliary I/O functions.

AUX I/O SIGNAL SPECIFICATIONS	
Digital Inputs	
Input Signals	Remote Inhibit, External Trigger Input, Phase Sync, User Inputs (3)
Voltage Levels	Logic low: $V_{in} < 0.4\text{ V}$ Logic High: $V_{in} > 2.0\text{ V}$
Input Impedance	10 k Ω
Absolute max. voltage	12V
Digital Outputs	
Output Signals	<i>Open Collector (0.5A max. protection):</i> FORM Relay Control, Transformer Relay Control Note: DO1 and DO2 are TTL outputs with 5.2V output and 200 Ω output impedance. Into a 5k Ω load, the output voltage is ~5V. Note: DO3 and DO4 are open-drain outputs with internal pull-up of 1k to 5.5V with a diode protection. At no load, these outputs will measure 5.5V. With a 5k Ω impedance, these outputs will measure ~4.6V. <i>TTL Level:</i> Relay State/Function Strobe / Trigger Out Phase Reference (sync output) User programmable outputs (2)
Voltage Levels @ 0.4 mA	Logic low: $V_{in} < 0.4\text{ V}$ Logic High: $V_{in} > 4.6\text{ V}$
Output impedance	200 Ω
Analog Inputs	
Signals	Analog Inputs (4)
Voltage Range	-10V – 10V
Accuracy	$\pm 0.1\%$ F.S.
Sampling Rate	10 Hz or 10 times/sec

AUX I/O SIGNAL SPECIFICATIONS	
Open Circuit Level	2 ~ 3 % of F.S. if analog input is left floating (no connection)
Input Impedance	5 kΩ
Absolute max. voltage	12V
Analog Outputs	
Signals	Analog Outputs (4)
Voltage Range	0V – 10V
Accuracy	± 0.1 % F.S. (with 5 kΩ load or higher)
Update Rate	10 Hz or 10 times/sec
Output Impedance	5 kΩ
Power	
Output	12.0 Vdc
Accuracy	± 0.1 Vdc
Max. Current	0.5 Adc
RS232	
Signals	Tx, Rx
Handshake	Xon/ Xoff
Baud rates	9600 – 460800 bps

Auxiliary I/O Signal Protection Information and Recommendations

- All the signals on the auxiliary I/O DB25 port have double insulation with respect to high voltage. They are safe to touch (SELV) and safe to connect to any other equipment.
- These signals are referenced to earth, so any data acquisition card or equipment used to control the power source should be referenced to the same earth as the power source. For the power source unit, earth is its chassis.
- If the controlling computer connected to the power source is connected to an earth with different potential - this can happen when using different outlets or AC utility circuits - , that voltage difference can damage low-signal circuits.
- Analog outputs cannot be negative and cannot be higher than 5V. Any DAQ card or instrument used to monitor/read these outputs must have a sufficient input voltage range.
- In general, it is recommended to limit signal input voltages with series resistors and clamping diodes in case the “source” can generate a voltage higher than the maximum allowed by the analog inputs of the power source. See relevant specification on the previous page.

4.15 Electronic Load Mode (Option L)

The following specifications apply to AZX models configured with optional Electronic Load mode (Option L).

4.15.1 Constant Current (CC) Mode

See section 4.3 and 4.4 for respective AC and DC Current ranges as a function of voltage range and phase mode.

4.15.2 Constant Current (CR) Mode

Constant Resistance Mode (CR)	
Programming Ranges	
Resistance RMS	0.01 Ohm to 99.999 kOhm / Infinite = 100 kOhm
Conductance RMS	0.00 mS to 70859.90 mS

4.15.3 Constant Power (CP) Mode

See section 4.1 for respective Watt and VA ranges as a function of phase mode.

4.15.4 Circuit Emulation (CE) Mode

Circuit Emulation (CE) Mode	
Programming Range	
Resistance	0.01 Ohm to 100 kOhm
Inductance	0.001 mH to 100,000 mH
Capacitance	0.001 uF to 100.000 uF
Initial Voltage	0.00 to 2000.00 V

4.16 Hardware in the Loop Option H

The following technical specifications apply to the available hardware options. See section 7.3.5, "DB25 Connector REAL TIME I/O Pin locations – Option “H” on page 224 for pinout configuration for Option H Real Time Analog DB25 connector.

Option Suffix	Description
H	Real Time I/O option for PHIL applications.

4.16.1 Option H (HIL Real Time Interface)

REAL TIME I/O SIGNAL SPECIFICATIONS	
Analog Programming Inputs	
No. of Signals	Analog Inputs, 3 One per phase, configurable as voltage or current setpoint
Voltage Range	Standard: -10V - +10V Optional: -16V - +16V
Signal Type	Single Ended or Differential Programmable gain and offset. In Single Ended mode, negative inputs have to be connected to Gnd. In Differential mode, use positive and negative inputs differentially.
Accuracy	< 0.5%
Sampling Rate	500 ksps
Input Impedance	> 10 kOhm
Absolute max. voltage	12V (input saturates at 10V).
Analog Monitoring Outputs	
No. of Signals	Analog Outputs, 6 3 phase outputs mirror currents in real-time 3 phase outputs mirror voltage in real-time
Voltage Range	Standard: -10V - +10V Optional: -16V - +16V
Signal Type	Single Ended (SE) or Differential (DI) mode. <ul style="list-style-type: none"> In SE mode, output is from _P to GND, signal is +/-10V In DI mode, output from _P to _N, signal is +/- 20V. In DI ode, output is from _P to GND, signal is +/-5V
Accuracy	< 0.5%
Update Rate	Real time analog signal
Output Impedance	< 10 Ohm

5 Unpacking and Installation

5.1 Inspection

The AZX Series® of AC power sources are carefully inspected before shipment. If instrument damage has occurred during transport, please inform Pacific Power Source' nearest sales and service office or representative.

All AZX models require three-phase AC input and are furnished with a compression terminal block for AC input. A suitable line cord and power disconnect is required (but not included) to connect these power supplies to the mains.

Refer to "check line voltage" to check the line voltage selection and fuse type.

Note: For input and output connections to paralleled AZX cabinet systems, refer to Section 5.14, "Parallel Cabinets System" starting on page 98.

5.2 Lifting and Carrying Instructions



WARNING

THIS UNIT IS HEAVY. A forklift or pallet jack is required to move this unit. DO NOT attempt to lift cabinet.



AVERTISSEMENT

CET APPAREIL EST LOURD. Un chariot élévateur ou un transpalette est nécessaire pour déplacer cet appareil. NE PAS tenter de soulever l'armoire.

This equipment weighs over 517 Kg / 1140 lbs. To remove the equipment from its shipping crate, use a forklift or a ramp after removing the crate's side panels. .

For use, the unit must be placed on a flat floor capable of supporting the full weight of the AZX cabinet.

5.3 Verify Correct AC Input Line Voltage

The AZX Series® power supply can be ordered with a range of 3 phase AC input voltage configurations. Prior to connecting the AC power source to the local mains, it is important to check the type label on the unit to verify that its AC input configuration matches the local utility power.

Do not connect the power supply to the mains if the AC input voltage, phasing and frequency does not match.



WARNING

DO NOT CONNECT A 400 V AC INPUT AZX MODEL TO A 480V OR HIGHER THREE PHASE UTILITY LINE VOLTAGE AS DAMAGE TO THE UNIT MAY OCCUR.

DO NOT CONNECT A 480 V AC INPUT AZX MODEL TO A 208V OR 400V THREE PHASE UTILITY LINE VOLTAGE AS THE UNIT WILL NOT OPERATE.



AVERTISSEMENT

NE PAS CONNECTER UNE 400 V AC ENTRÉE AZX MODÈLE À UN 480V OU PLUS DE TROIS PHASES UTILITAIRE TENSION EN PANNE QUI PEUT SE PRODUIRE.

NE PAS CONNECTER UNE 480 V AC ENTRÉE AZX MODÈLE À UN 208V OU 400V TRIPHASE UTILITAIRE TENSION QUE L'APPAREIL NE FONCTIONNE PAS.

5.4 AC Input Connections



WARNING

The AC input connections must include a disconnect device (an external switch or circuit-breaker) as part of the installation. The disconnect device must be suitably located and easily reached and must be marked as the disconnecting device for the equipment. The disconnect device must disconnect all line conductors simultaneously.

An external overcurrent protection device must be provided (by, e.g., fuses or circuit breaker). The breaking capacity of the overcurrent protection device should be compatible with the current rating of the installation.

A minimum of basic insulation is required between mains-connected parts of opposite polarity on the supply side of the overcurrent protection device.

Overcurrent protection devices shall not be fitted in the protective conductor. Fuses or single pole circuit-breakers shall not be fitted in the neutral conductor of multi-phase equipment.

Installation should be in accordance with ANSI/NFPA 70, NEC.



AVERTISSEMENT

Les connexions d'entrée AC doivent inclure un dispositif de déconnexion (un commutateur externe ou disjoncteur) dans le cadre de l'installation. Le dispositif de déconnexion doit être convenablement situé et facilement accessible et doit être marqué comme le dispositif de déconnexion de l'équipement. Le dispositif de déconnexion doit déconnecter tous les conducteurs de ligne simultanément.

Un dispositif de protection de surintensité externe doit être fourni (par exemple, par des fusibles ou coupe-circuit). Le pouvoir de coupure du dispositif de protection contre les surintensités doit être compatible avec le courant nominal de l'installation.

Un minimum d'isolation de base est nécessaire entre les parties de réseau connecté de polarité opposée sur le côté d'alimentation du dispositif de protection contre les surintensités.

Les dispositifs de protection contre les surintensités ne doivent pas être installés dans le conducteur de protection. Fusibles ou simples disjoncteurs ne doivent pas être installés dans le conducteur neutre des équipements multi-phasés.

L'installation doit être conforme à la norme ANSI / NFPA 70, NEC.



CAUTION: USE COPPER CONDUCTOR WIRING ONLY

Use only copper conductor (CU) wiring for all AC Input, AC and DC Output and Ground Connections.

**ATTENTION: UTILISER UNIQUEMENT LE CÂBLAGE DU
CONDUCTEUR EN CUIVRE**

Utilisez uniquement un câblage à conducteur en cuivre (CU) pour toutes les connexions d'entrée CA, de sortie CA et CC et de mise à la terre.

5.4.1 Checking Rated AC Input Voltage

Units are shipped from the factory set to the AC input voltage rating specified at the time of order. The AC input setting is shown on the Model Serial Tag label affixed on the back panel in the upper left hand corner when facing the back of the cabinet.



Always check to see the indicated configured AC input voltage match that of the local utility power. If not, **DO NOT CONNECT** the unit to the power grid as damage may result from an incorrect voltage application.

5.4.2 Changing AC Input Voltage Settings

If a unit is moved to a different location where the correct AC voltage is not present, the AC input may be reconfigured by authorized service personnel only and after contacting customer service. A new Serial Tag label will have to be provided and affixed after the changeover. Only two settings are available:

- 480Vac 3~ Typical for US, Canada, Mexico
- 380-415Vac 3~ Typical for Europe, UK, Asia

Note: For 200Vac 3~ or 208Vac 3~ requirements, contact factory. These input settings are not available on standard units.

To change an existing units' AC input voltage setting, contact customer service for directions on how to proceed.

5.4.3 AC Input Voltage Monitoring Relay

The power source has an extensive set of AC line monitoring protection mechanisms. These settings may have to be changed when relocating the power source to a different region or to accommodate local AC Mains specifications.

A Phoenix EMD-BL-PH electronic monitoring relay is located on the left side of the cabinet. This relays monitors the following AC line parameters:

- Phase Sequence (Rotation)
- Phase Loss
- Voltage Unbalance

To access this relay to check or adjust setting, the left panel has to be removed.



Never access this device to change settings or remove cabinet panels unless mains power is disconnected from the cabinet.

Indicators and Controls (Refer to Figure 5-1)

1. LED: output relay R
2. LED: failure
3. LED: supply U
4. "DELAY" potentiometer: Response delay
5. "ASYM" potentiometer: Asymmetry
6. Snap-on foot for DIN rail mounting

Protection adjustment ranges are shown in the table below.

Parameter	Min	Max
AC Voltage	187 Vac	519 Vac
Frequency	48 Hz	63 Hz
Response delay	0.1 sec	10 secs
Recovery Time		500 msec
Voltage Asymmetry (Unbalance)	5 %	25 %

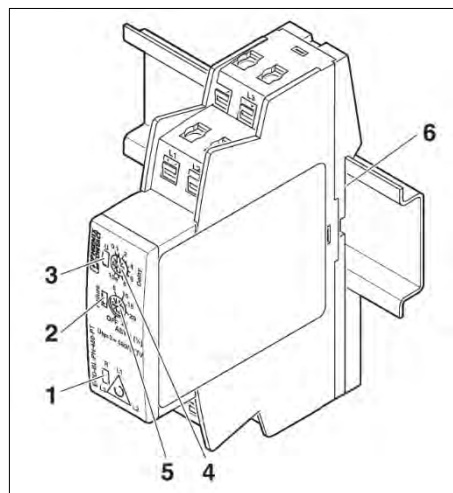

Figure 5-1: AC Input Line Monitor

If any of the programmed settings are exceeded, the power source will trip off and has to be manually restarted as described in section 5.7.

5.4.4 AC Input Connections

Consult the table below for recommended wire size by model number and AC input rating.

MODEL	INPUT VOLTAGE	INPUT CURRENT	RECOMMENDED INPUT SERVICE	MINIMUM COPPER WIRE SIZE, 75°C RATED
3300AZX-400	380/400 V ac, 3~	55 A rms, max	70 A rms	21.2 mm ² (AWG 4)
3300AZX-480	480 V ac, 3~	45 A rms, max	60 A rms	13.3 mm ² (AWG 6)
3550AZX-400	380/400 V ac, 3~	90 A rms, max	100 A rms	33.6 mm ² (AWG 2)
3550AZX-480	480 V ac, 3~	72 A rms, max	90 A rms	26.7 mm ² (AWG 3)

Table 5-1: AC Input Wire Size Table

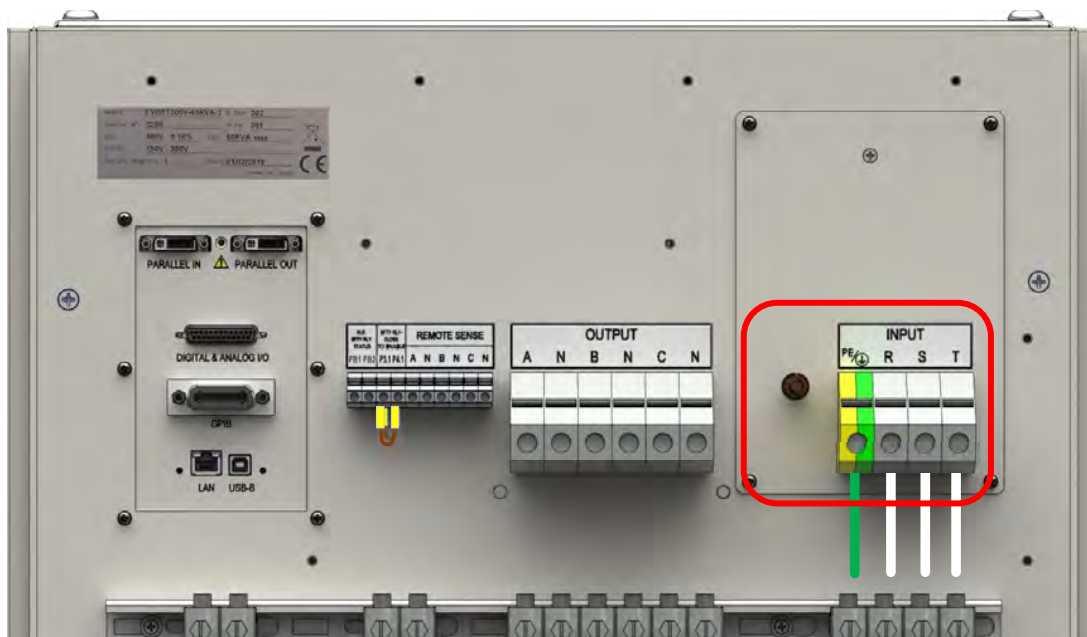

Figure 5-2: AC Input Terminal Location on rear panel of AZX cabinet

The AC input connections must be made at the rear panel AC terminal block. The safety cover that must be removed to connect the unit to the utility grid and re-installed when done.

Note: To access the AC input terminal block, the rear panel safety cover must be removed first by removing the 6 screws (see image to the right).

Note: The AC input terminal uses the standard Supply Input reference of **R-S-T**. This is equivalent to L1-L2-L3 phasing.

Note: There is **NO AC INPUT NEUTRAL** Connection so either a Delta or Wye grid service can be used as long as the Line to Line voltage rating matches the configured input voltage setting.

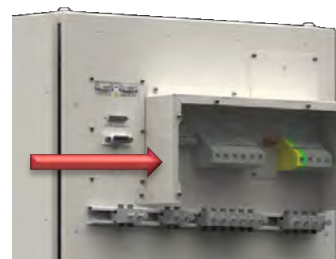

The following wire strip lengths are required for the AC input wires listed.

R, S, T Wires: 11/16", 17 mm

Neutral, Ground Wires: 3/4", 19 mm

Wire Strip Length

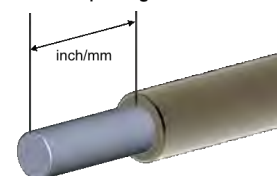

The AC input terminal phasing is marked on the rear panel and shown in Figure 5-2. A four wire mains connection is required. (L1, L2, L3 and Earth Ground). Protective Ground connection can be made using either the Ground Stud to the left of the AC Input terminal block or using the PE Terminal Position on the AC Input terminal block itself.

Note: To relief stress on the AC Input terminals of the power source, use the strain reliefs located directly below the AC Input terminal block – see image below - to support the weight of the AC input wiring.



5.4.5 Power On Procedure

Once AC input power is connected to the power source and the rear panel safety cover is installed, the unit can be powered up by following the following startup procedure:



1. Make sure the **EMERGENCY STOP** Switch located above the front panel on the left is not depressed. If it is, pull it out and twist it to lock it in the non-depressed position
2. Press the **FAULT RESET** Button located above the front panel on the right to clear the unit for power-on
3. Pull the Circuit breaker lever located on the lower left corner of the unit to the upper position. See section 5.6 on page 77.
4. The unit will now go through the power-on process. Wait for the controller to boot up completely and display to show the PROGRAM screen before attempting to operate the unit.

Refer to the image below for OFF and ON Positions of Circuit Breaker.



Figure 5-3: Mains CB in **OFF** (lower) Position



Figure 5-4: Mains CB in **ON** (upper) Position

5.4.6 Safety Circuits Status Monitor

The Safety Circuit Status Monitor LED indicators monitor the safety circuits and can be helpful in troubleshooting grid connectors or startup problems. These LEDs are located to the right on the Circuit Breaker panel on the lower front of the unit.



The LEDs are numbered 1 through 7 from left to right.



The table below describes the purpose of each LED and provides hint on troubleshooting issue based on the status of these lights.

LED	FAULT	POSSIBLE CAUSE	SOLUTION
1	Emergency Stop	Emergency Stop Switch	<ul style="list-style-type: none"> Release the emergency stop button on the Front Panel: rotate its red cap until it releases.
2	Phase Detector	Phase detector relay	<ul style="list-style-type: none"> Check the correct sequence of the input line phases. Swap two of the input phases if needed. Check the asymmetry (voltage balance) in the input line phase voltages. Check that the 3 input phase lines are present. Check for duplicated phases.
3	Residual Current Monitor	Electronic residual current relays	<ul style="list-style-type: none"> Disconnect the output Load. If the problem persists, contact customer service.
4	XFMR TC	XFMR thermistors	<ul style="list-style-type: none"> If the unit was ON, there was an overtemperature condition: remove and clean all the air filters. Also, ensure there is no obstruction of the top air outlets and front air inlets. If the unit was OFF, contact customer service.

LED	FAULT	POSSIBLE CAUSE	SOLUTION
5	Open Door	Rear panel door SW	<ul style="list-style-type: none"> • If the rear panel is open, close it. Try pressing the left side of the rear panel about halfway up the panel. If the problem disappears, tighten the rear panel screws.
6	Remote Contact (Rear)	Missing rear panel contact	<ul style="list-style-type: none"> • Close the rear panel remote inhibit contact (short with a jumping wire).
7	UVR	Safety relay	<ul style="list-style-type: none"> • All the other LEDs must be on for this one to be on. • First Press the RESET button. • Second, if LED is still off, press EPO button, rotate EPO button red cap, and final press RESET button. • If the problems persists, contact customer service.

Table 5-2: Safety Circuits Status Monitor

5.5 Grounding Requirements

5.5.1 Chassis Ground Connection Required



WARNING

SHOCK HAZARD: Equipment must be grounded.



AVERTISSEMENT

RISQUE DE CHOC: l'équipement doit être mis à la terre.



CAUTION: USE COPPER CONDUCTOR WIRING ONLY

Use only copper conductor (CU) wiring for all AC Input, AC and DC Output and Ground Connections.



ATTENTION: UTILISER UNIQUEMENT LE CÂBLAGE DU CONDUCTEUR EN CUIVRE

Utilisez uniquement un câblage à conducteur en cuivre (CU) pour toutes les connexions d'entrée CA, de sortie CA et CC et de mise à la terre.

The unit **MUST** be grounded via the AC Input. A line cord with proper Earth Ground must be used at all times. Correct grounding of your electrical system infrastructure according to applicable national standards must also be observed.

5.5.2 Output Neutral Grounding

The output neutral terminals of the power source are **NOT** connected to earth ground but rather floating. This allows the output of the power source to float with respect to ground. Some loads will have their neutral input grounded, which will result in the power source neutral being grounded through the load. Alternatively, the user may ground the output

neutral terminals himself by running a suitable wire size from one of the output neutral terminals to the ground stud on the rear panel of the power source as shown in

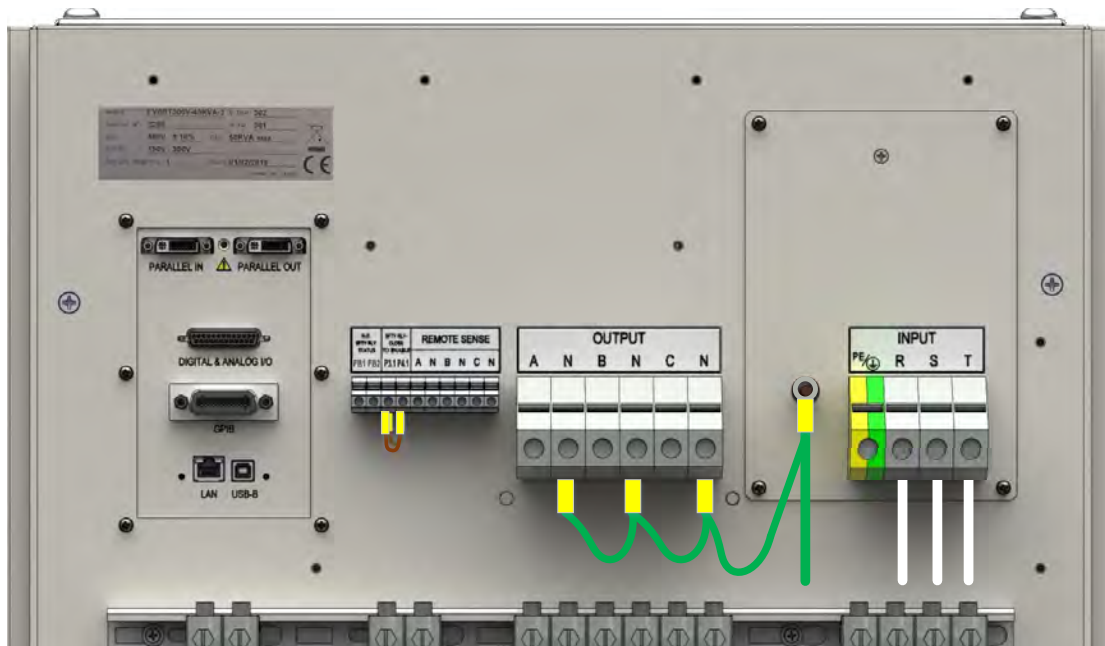

Figure 5-5: Grounding Floating Neutral Outputs

5.6 AC Input Circuit Breaker

This product is fitted with a mains input circuit breaker on the lower left hand side of the front of the cabinet. The power off position of the circuit breaker handle is marked “O”. The power on position of the circuit breaker is marked “I”. The Fault trip position is in the middle position between these.

Refer to the next section if the unit won’t turn on because the CB trips back to the trip (center) position.

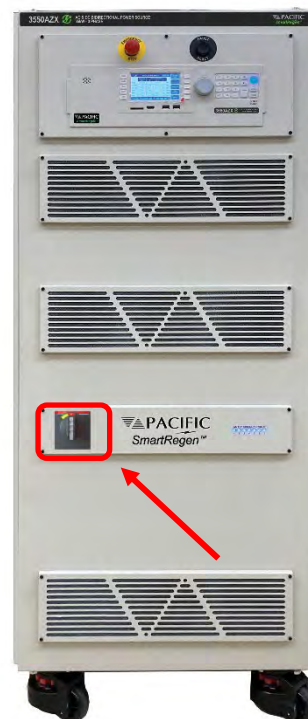

Figure 5-6: Input Power On/Off CB

5.7 Emergency Shutdown & Restart Procedure

The AZX is equipped with an emergency circuit that opens the main AC input circuit breaker. This emergency system is always powered, even when the circuit breaker is in the OFF (O) position. The emergency circuit is triggered by any of the following **eight conditions**:

- The mushroom style push button located above the control panel on the front of the AZX is pressed by an operator
- The cabinet's rear panel is opened
- Any of the following AC mains Input Faults:
 - phase rotation error
 - phase loss
 - phase imbalance
- Input Transformer Over-temperature fault
- An external interlock circuit is opened
- Leakage Current Detector is tripped

When the emergency circuit is triggered, the mains circuit breaker is opened and locked in the center trip position causing the AZX to power down.

To re-engage the power source after an emergency shut-down, the following steps must be followed:

- Make sure that all conditions that caused the shut-down have been cleared. Check AC input voltage level, phase rotation (swap B and C as needed), frequency, voltage unbalance or missing phase before proceeding.
- Twist and pull the mushroom switch to disengage.
- Press the RESET Button to release the circuit breaker lockout. The RESET button is located above the control panel on the front of the AZX.
- Turn the power source back ON (1) using the circuit breaker.

5.8 Airflow

The AZX Series® of AC power sources are cooled by drawing in air through the front and out at the top of the cabinet. Do not place the cabinet in a manner that blocks the free flow. Allow a minimum of 3 feet / 1 meter free of obstructions in front of the cabinet to prevent overheating.

Note: Refer to section 5.11 on page 80 for instructions on air filter maintenance.

5.9 Sound Levels



WARNING

Sound pressure level should be measured both at the operator's position in normal use and at whatever point 1 meter from the power source enclosure that has the highest sound pressure level.

The installer shall provide measures to reduce the sound pressure level at the operator's point of use to a safe level. These measures may include the fitting of noise-reducing baffles or hoods or provision of protective earpieces.



AVERTISSEMENT

Le niveau sonore doit être mesuré à la fois à la position de l'opérateur en utilisation normale et quelque soit le point à 1 mètre de l'enceinte de l'appareil qui a le niveau sonore le plus élevé.

L'installateur doit prendre des mesures visant à réduire le niveau sonore au point d'utilisation de l'opérateur. Ces mesures peuvent inclure la mise en place de hottes antibruit, ou la fourniture d'oreillettes de protection.



When the equipment is operated at or near full rated output power, fan speed will be at its highest and corresponding noise levels will be higher. Operators should wear ear protection while exposed to these levels of sound.

5.10 Cleaning



CAUTION

BEFORE you clean the unit, switch the unit off at the front panel breaker AND remove all mains power using the mains disconnect.

- Please do NOT use any organic solvent capable of changing the nature of the plastic such as benzene or acetone.
- Please ensure that no liquid is allowed to penetrate this product.



ATTENTION

AVANT de nettoyer l'appareil, mettez l'appareil hors tension au niveau du disjoncteur de face avant ET retirez tout câble d'alimentation secteur.

- Ne pas utiliser **de** solvant organique capable de changer la nature de la matière plastique tel que le benzène ou l'acétone.
- Veiller à ce qu'aucun liquide ne pénètre à l'intérieur de l'appareil

To clean this product, use a soft or slightly damp cloth.

5.11 Air Intake Filter Removal and Cleaning

The power source is equipped with removable air intake filters that must have their filter material cleaned on a regular basis. A six-month cleaning interval is recommended. For units deployed in particularly dirty environments, this cleaning interval should be shortened to three months or less to prevent the air filters from clogging up with dirt.

5.11.1 Air Filter Removal

To remove the air filter, proceed as follows:

1. Turn the unit off first.
2. Using an Allen key driver, remove the screws from each corner of the filter panels on the front of the unit.
3. Removed each filter panel carefully and remove the filter material.



5.11.2 Filter Cleaning

Use warm water and some mild detergent to rinse all dirt out of the filter materials. Allow the filters to dry for two hours or more until fully dry before re-installing. If the filter material is too dirty to clean, replace with a new filter. Contact customer service for replacement filters.

5.11.3 Air Filter Installation

To reinstall the filter material, proceed as follows:

1. Place the cleaned filter material against each fan set of the front panel.
2. Line up the filter materials so the corners align with the four corners on the unit.
3. Install the removable filter panel using the original screws.

5.12 Liquids Warnings

The AZX Series® of AC power sources offer no protection against liquid spills. Openings exist in the cabinet to allow air flow on the front panel and on the top panel. The top panel in particular is very porous and great care should be taken not to put any container or objects containing liquids on top of the cabinet. Any liquid spills can cause great damage to the unit, even when switched off.

Do not install this product in any area where liquids or chemicals are used that could spill into the unit.



WARNING

PRODUCT IS **NOT** SPILL PROOF: Do not place this unit in any area where liquids are used. **DO NOT** put any container or objects containing liquids on top of the cabinet. Any liquid spills can cause great damage to the unit, even when switched off.



AVERTISSEMENT

LE PRODUIT **N'EST PAS** ANTI-DÉVERSEMENT: Ne placez pas cet appareil dans un endroit où des liquides sont utilisés. NE placez AUCUN récipient ou objet contenant des liquides sur le dessus de l'armoire. Tout déversement de liquide peut causer de graves dommages à l'appareil, même lorsqu'il est éteint

5.13 Load Connections

**WARNING**

HAZARDOUS OUTPUT: The power source output may be set to hazardous voltage levels. It provides basic isolation from the AC input mains. Therefore, the output must always be considered hazardous. Connections must be inaccessible to the operator in all situations when AC input mains voltage is applied.

Always disconnect power supply from the mains before connecting or disconnecting to the hazardous output terminals.

**AVERTISSEMENT**

SORTIE DANGEREUSE: La sortie de l'appareil peut être réglée à des niveaux de tension dangereux. L'appareil fournit une isolation de base du réseau d'entrée AC. Par conséquent, la sortie doit toujours être considérée comme dangereuse. Les connexions doivent être inaccessibles à l'opérateur dans toutes les situations où la tension d'entrée secteur est appliquée.

Toujours débrancher l'alimentation secteur avant de connecter ou déconnecter les bornes de sortie dangereuses.

**CAUTION: USE COPPER CONDUCTOR WIRING ONLY**

Use only copper conductor (CU) wiring for all AC Input, AC and DC Output and Ground Connections.

**ATTENTION: UTILISER UNIQUEMENT LE CÂBLAGE DU CONDUCTEUR EN CUIVRE**

Utilisez uniquement un câblage à conducteur en cuivre (CU) pour toutes les connexions d'entrée CA, de sortie CA et CC et de mise à la terre.

Note: The AC power source can be configured for either single-phase output or three-phase output.

Note: The External Voltage Sense connector always has three phase and three neutral connections but in single-phase mode of operation, only the A phase and one neutral connection are required.

Load connections are made on the rear panel using the Output Connectors. The output connectors are labelled A – B – C. Each output phase has a separate neutral connector terminal positions but all neutrals are tied together internally. For balanced three phase AC Wye Load applications, only one neutral wire connection to the load is required.

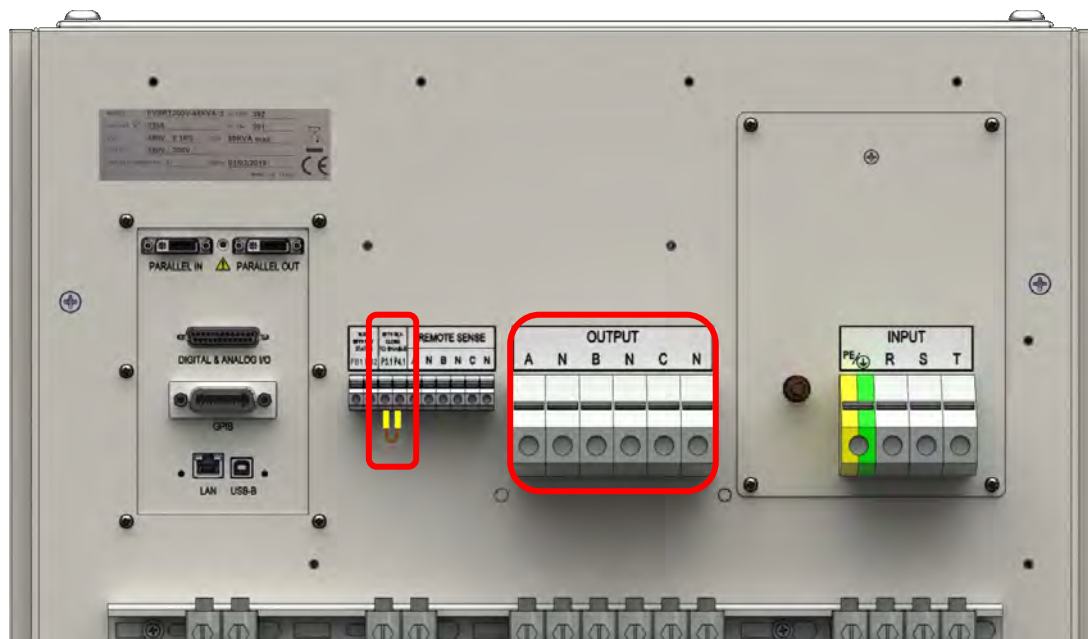

Figure 5-7: AC or DC Output Connection Terminals Location on AZX rear panel



Note: REMOTE INTERLOCK CONNECTION. To enable the AZX to power up, the Remote Interlock connector pins P3.1 and P4.1 **MUST** be shorted together. If no interlock is required, a shorting wire can be installed as shown above. If an interlock safety connection is required, connect P3.1 and P4.1 to a suitable remote safety shutdown switch. **Note** that restarting the AZX after a safety shutdown can only be done from the front panel. For Output On/Off remote requirements, refer to the AUX I/O section.

5.13.1 Output Wiring and Recommended Wire Sizing

Connections from the AC source output terminal to the load should be made using the output connector.

Load currents are a function of the load so care must be taken by the user to select appropriately sized output wires in accordance with local electrical codes.

Note: Since local electrical codes vary by location, Pacific Power Source **DOES NOT INCLUDE** any AC input or AC output wires with its power sources.

Maximum output voltage and current ratings of the available power source models is covered in section 4, “Technical Specifications” and should be consulted when determining correct wire size. Also, consider the voltage insulation rating of the load wires and External voltage sense wires used.

Note: To relief stress on the output terminals of the power source, use the strain reliefs located directly below the output terminal block – see image below - to support the weight of the output wiring.



5.13.2 Three Phase Wye Load Output Connection

The requisite WYE load output wiring is shown in Figure 5-9 using internal voltage sense and Figure 5-10 when using external voltage sense.

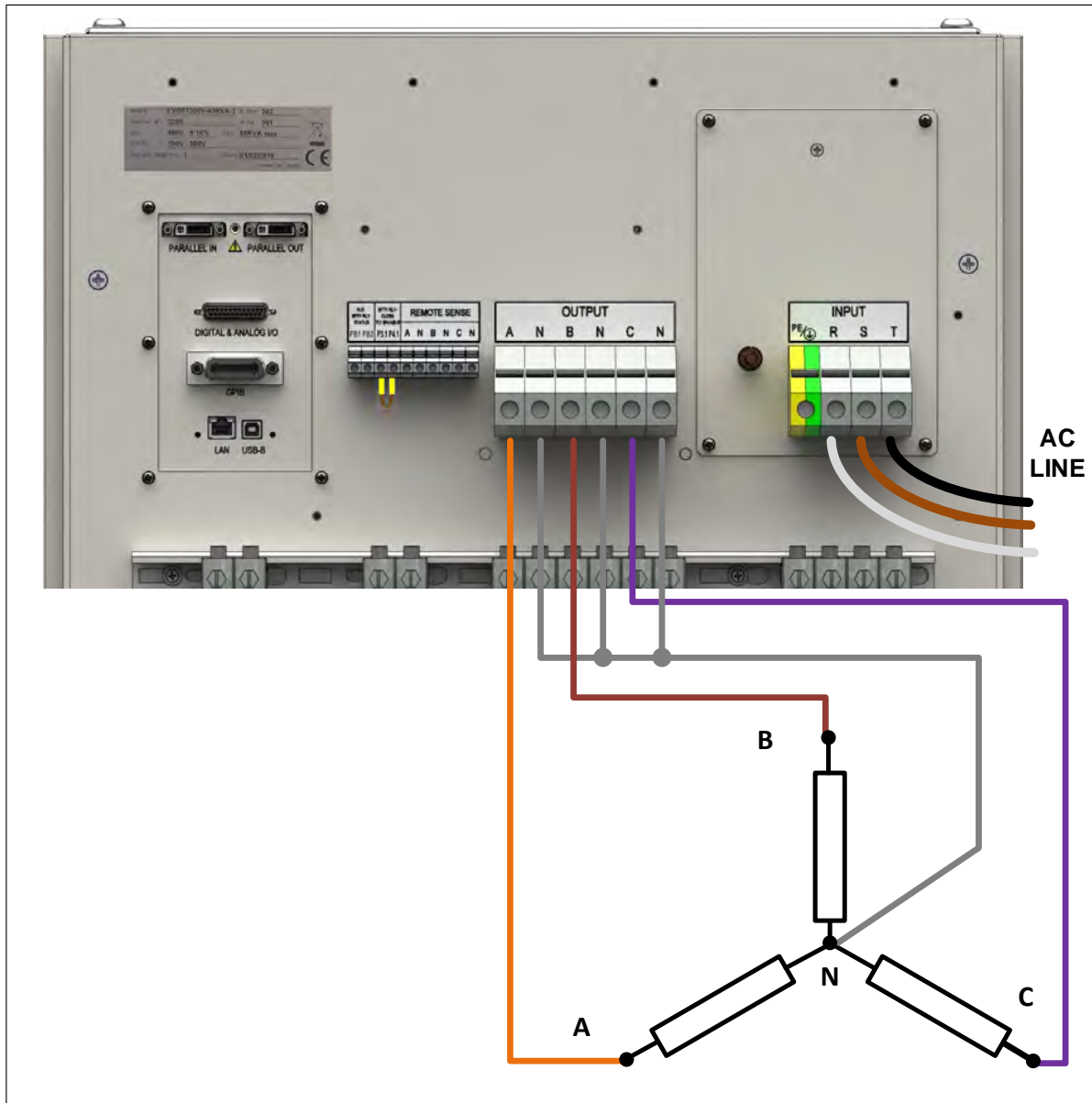

Figure 5-8: Three phase Wye Load Output Connections – Internal Voltage Sense

Note Load and sense wiring are **NOT** included with the power source and must be supplied by the end-user.

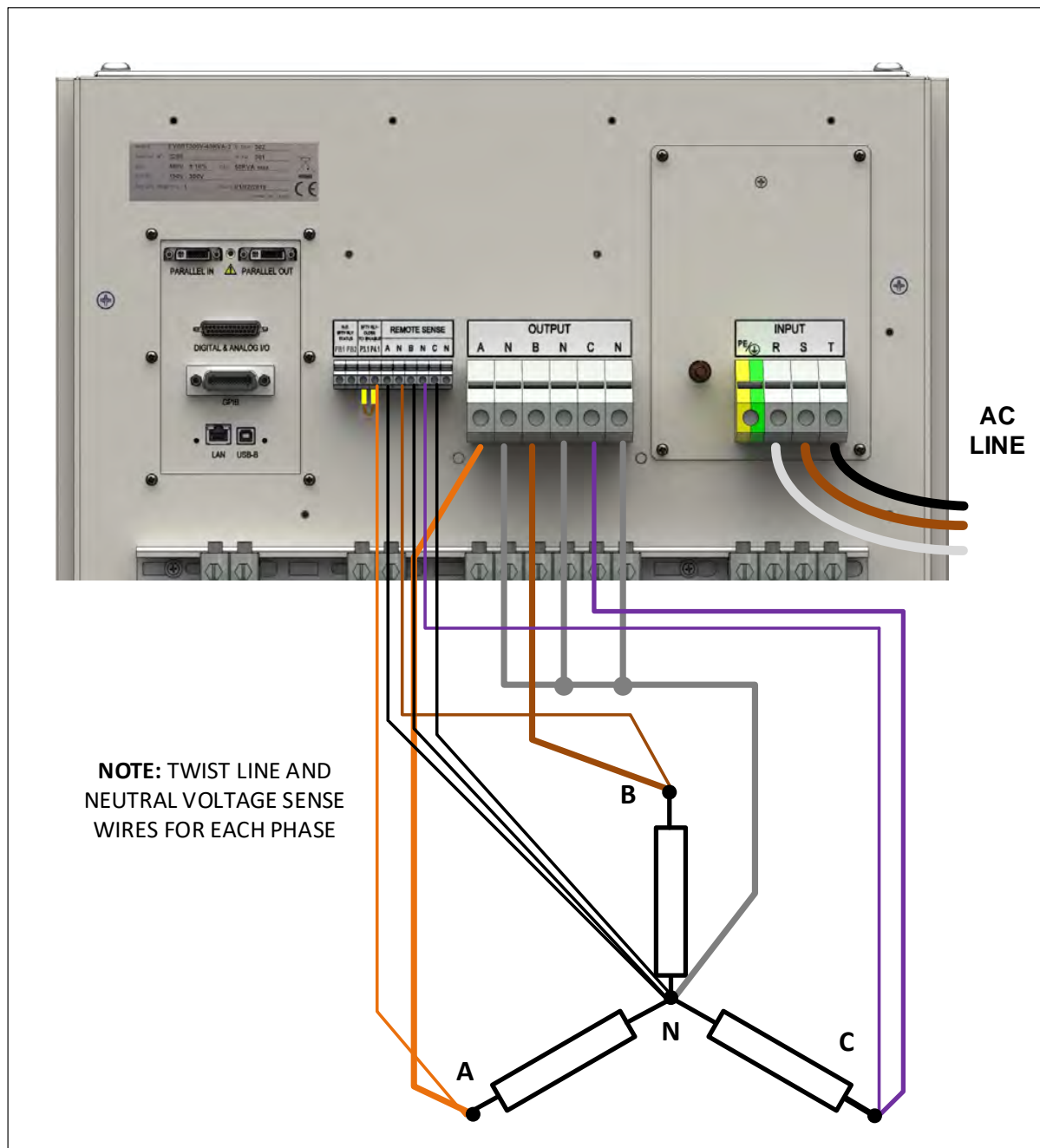

Figure 5-9: Three phase Wye Load Output Connections – External Voltage Sense

Note Load and sense wiring are **NOT** included with the power source and must be supplied by the end-user.

5.13.3 FORM4 and FORM5 Load Output Connections

Load connections on the AZX when operating in either FORM4 (Two outputs) or FORM5 (Three outputs) are similar to three phase WYE connections except there is no phase relationships or frequency commonality between the A, B and C outputs so each output drives a separate single-phase load.

Note that AZX units without the W Option still has a common neutral so the AN, BN and CN neutral terminals are shorted together inside the AZX.

For AZX units with the W option, the internal shorts have been removed so each output neutral is isolated from the others and can be floated at different levels with respect to ground as needed.

Connections for FORM4 and FORM5 respectively are shown in the next two figures.

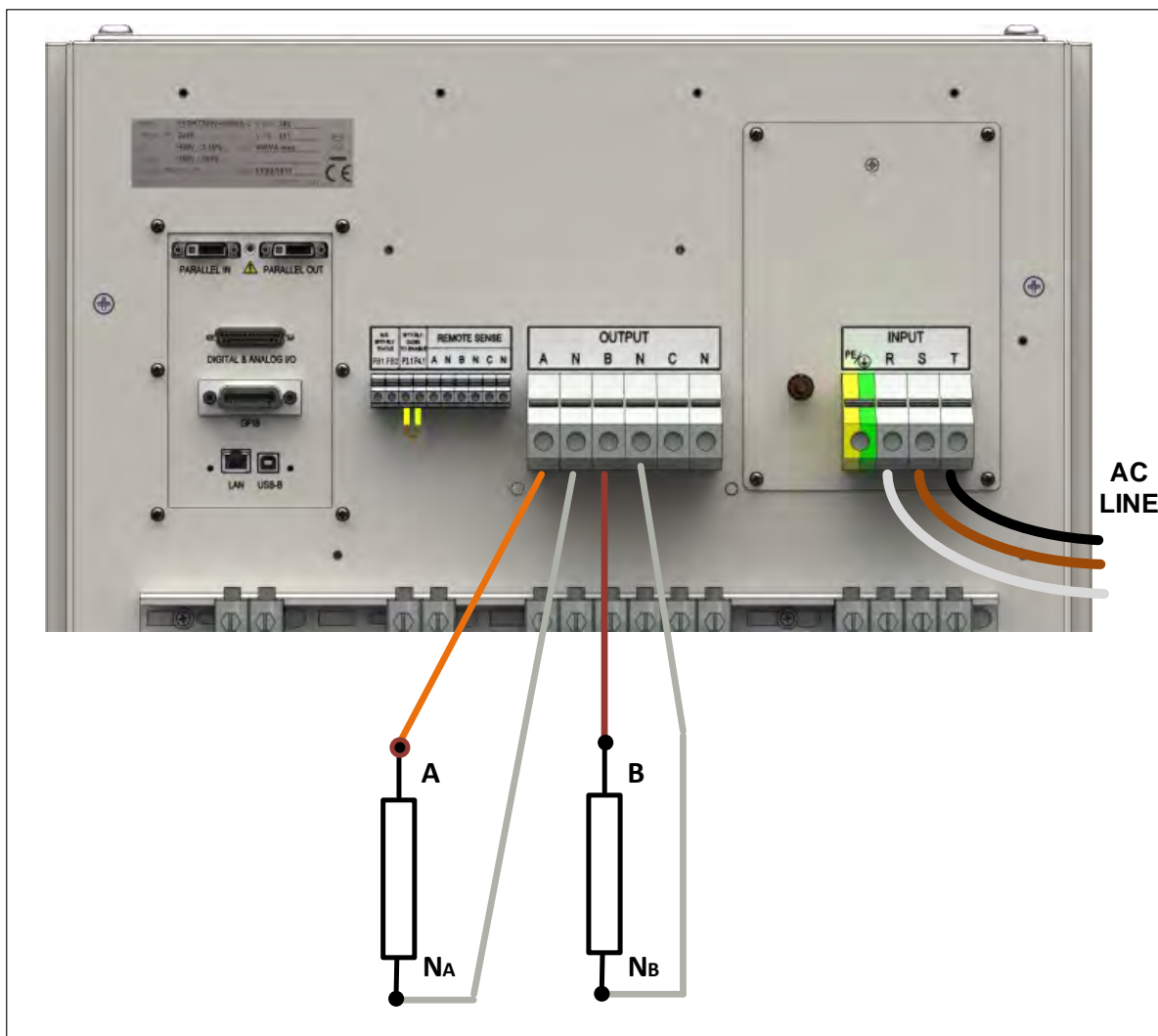

Figure 5-10: : FORM4 Two Outputs Load Output Connections

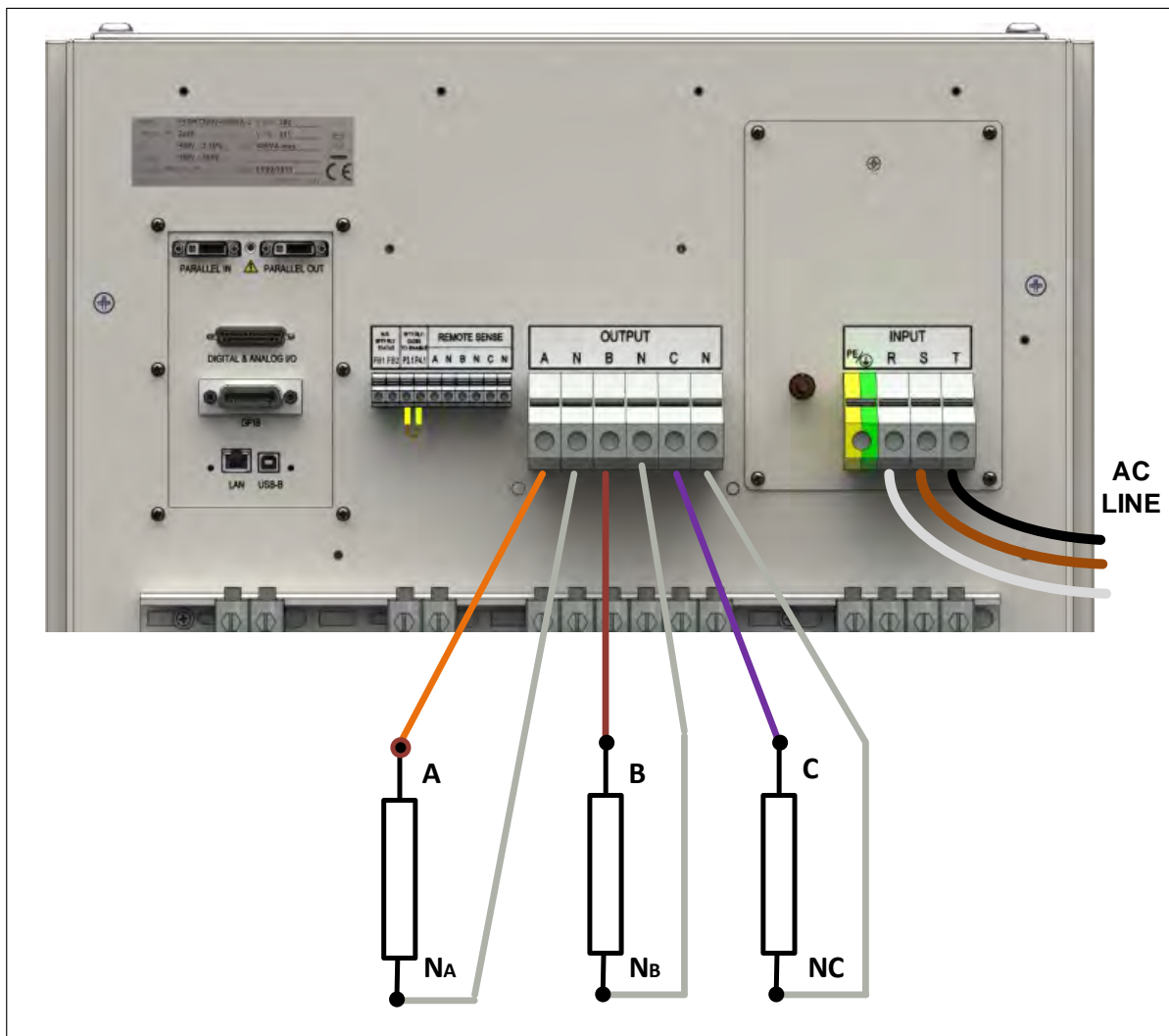

Figure 5-11: : FORM5 Three Outputs Load Output Connections

5.13.4 Three Phase Delta Load Output Connection – Standard AZX

The requisite DELTA load output wiring is shown in Figure 5-11 using internal voltage sense and Figure 5-12 when using external voltage sense.

Note Load and sense wiring are **NOT** included with the power source and must be supplied by the end-user.

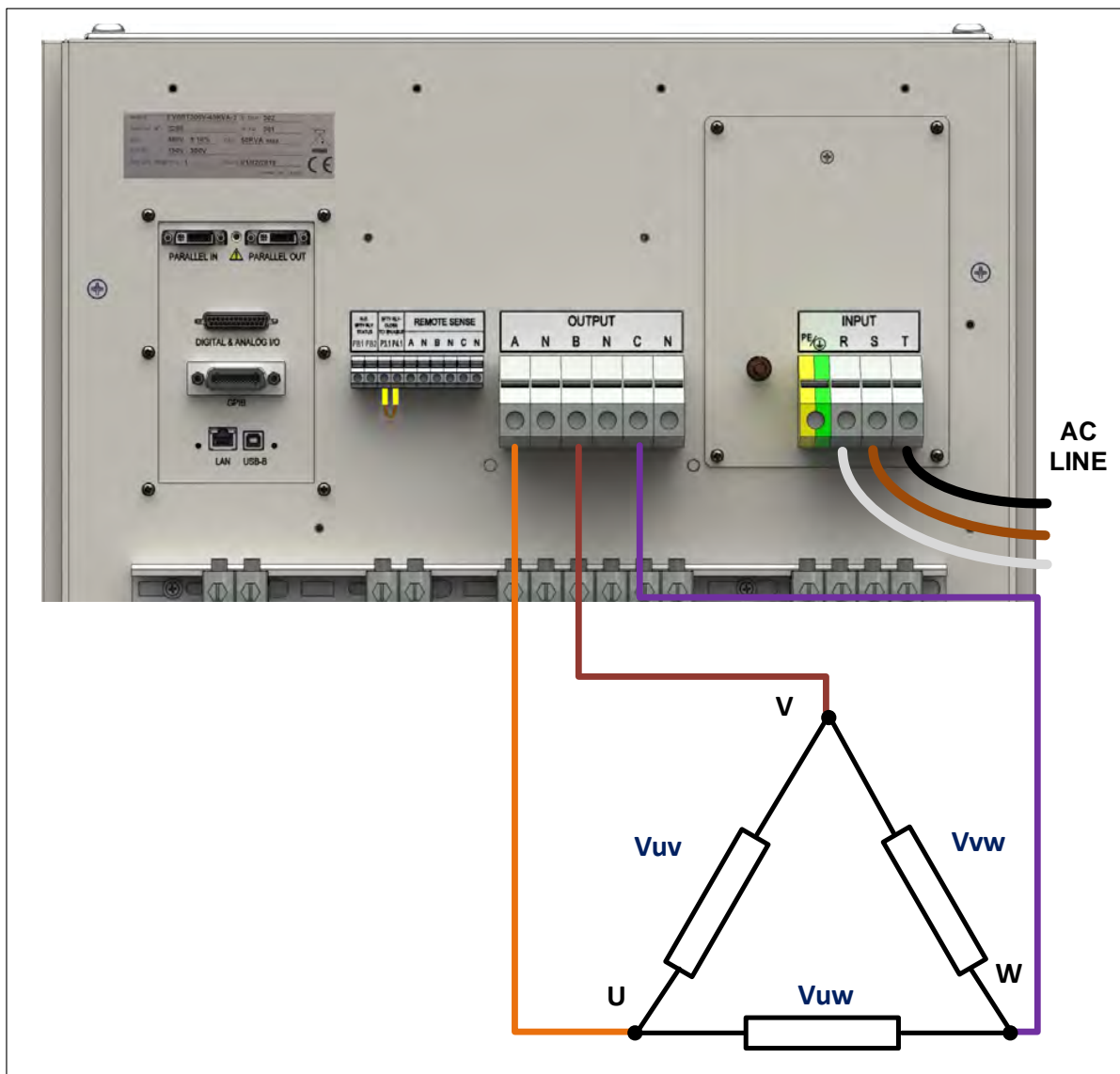

Figure 5-12: Three phase Delta Load Output Connections – Internal Voltage Sense

Note Load and sense wiring are **NOT** included with the power source and must be supplied by the end-user.

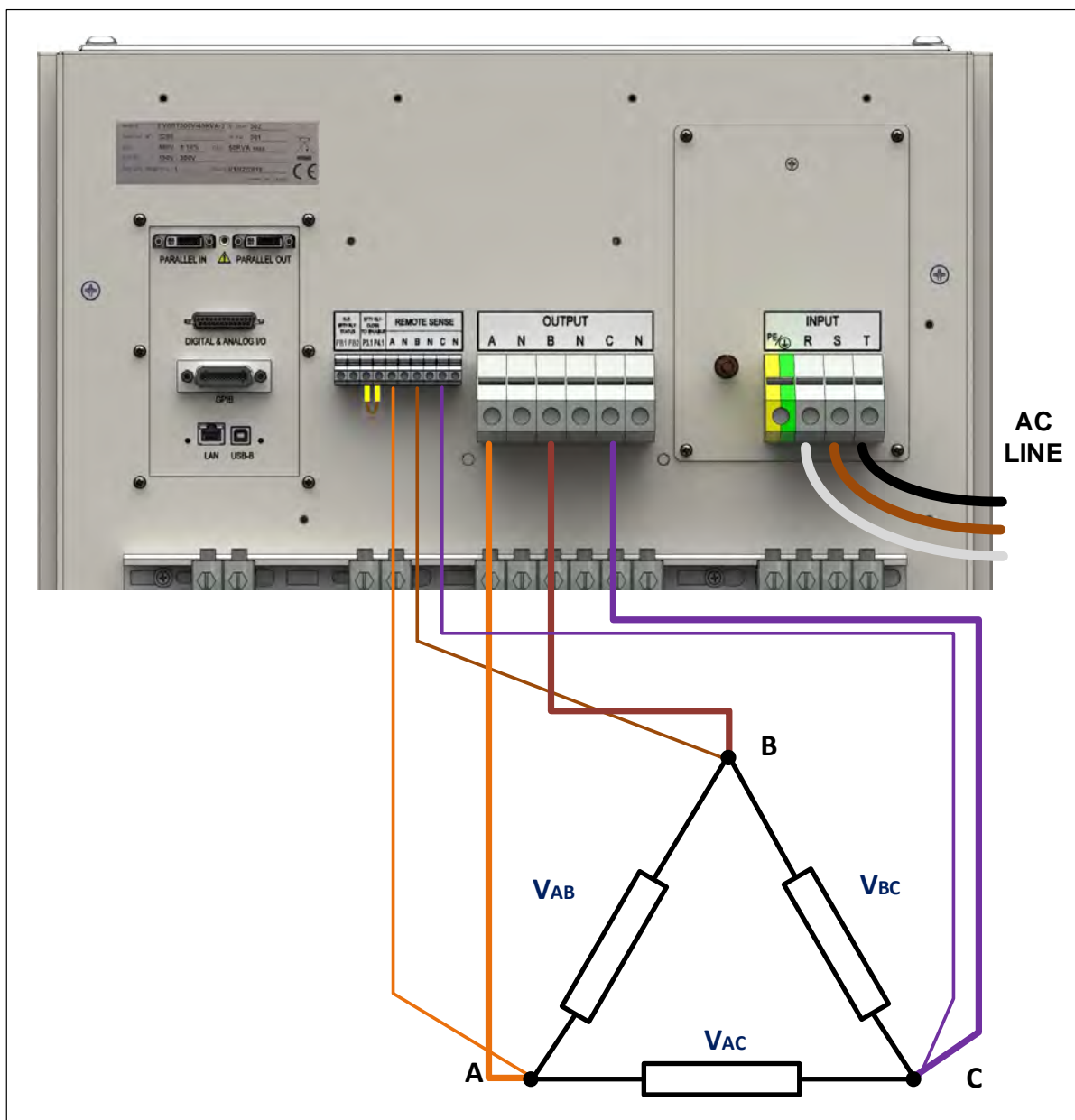

Figure 5-13 Three phase Delta Load Output Connections – External Voltage Sense

5.13.5 Three Phase Delta Load Output Connection – AZX with W Option

The requisite DELTA load output wiring for AZX Sources configured with the Isolated Neutrals (Option W) is shown in Figure 5-14. The three Neutrals **MUST** be shorted externally on AZX_W models to operate correctly.

Note Load and sense wiring are **NOT** included with the power source and must be supplied by the end-user.

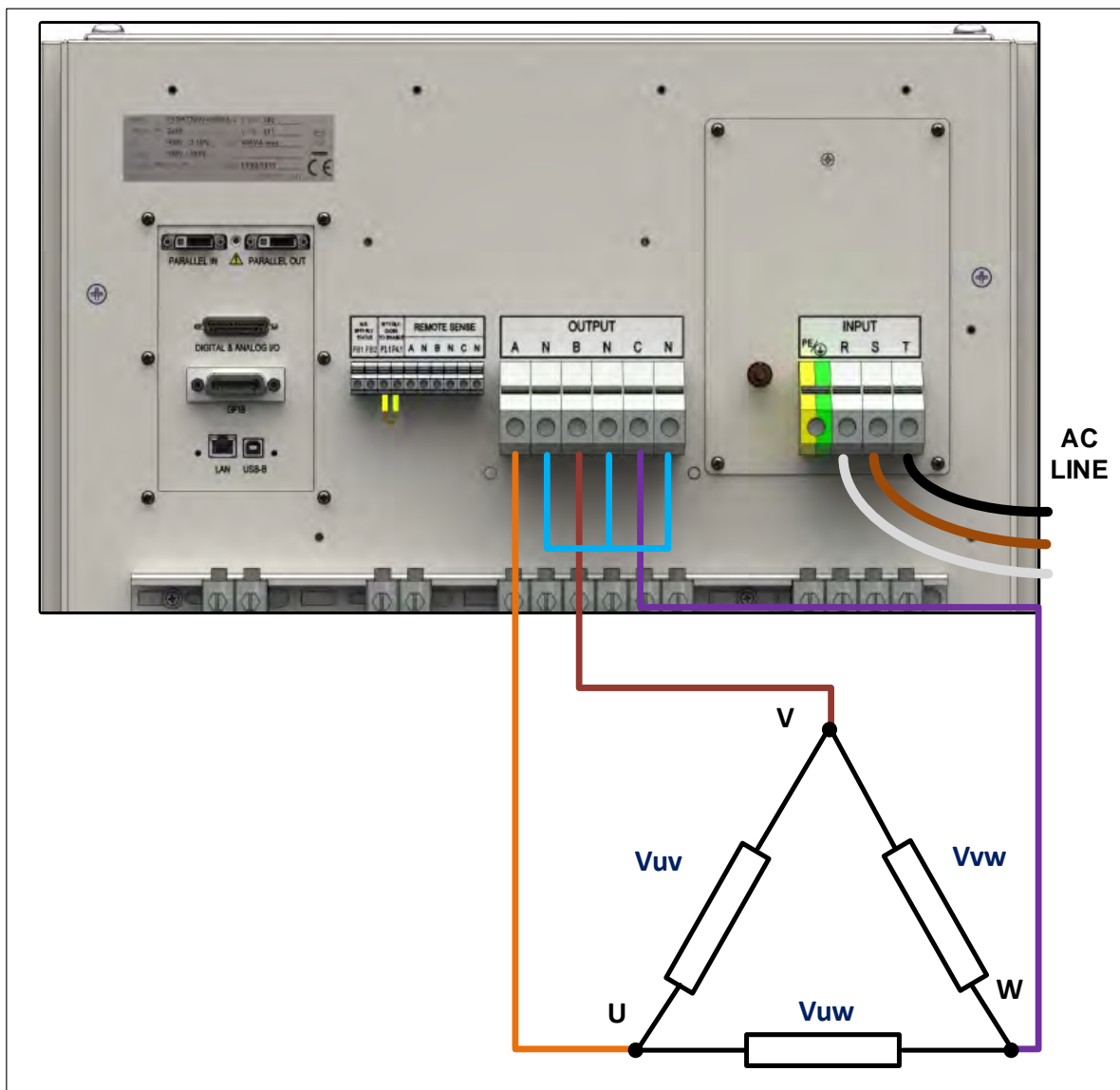

Figure 5-14: Three phase Delta Load Output Connections on AZX-W

5.13.6 Load Mode Three Phase Load Connections & W Option

When operating in electronic load mode – Option L – care must be taken to use to correct three phase connections when connecting to a Delta AC Source. Unlike a Wye (aka Star) AC Source connection, to connect a 3-phase electronic load to a Delta AC Source, the load must be configured with isolated Neutrals for each phase on the “Output (load input)” Terminal block. This requires the “W” option which implies the AZX is shipped from the factory with isolation Neutrals (NA, NB and NC). This means each phase (load input) has its own neutral, not internally connected to the other two phase (input) neutrals as is the case for an AZX without the W option.

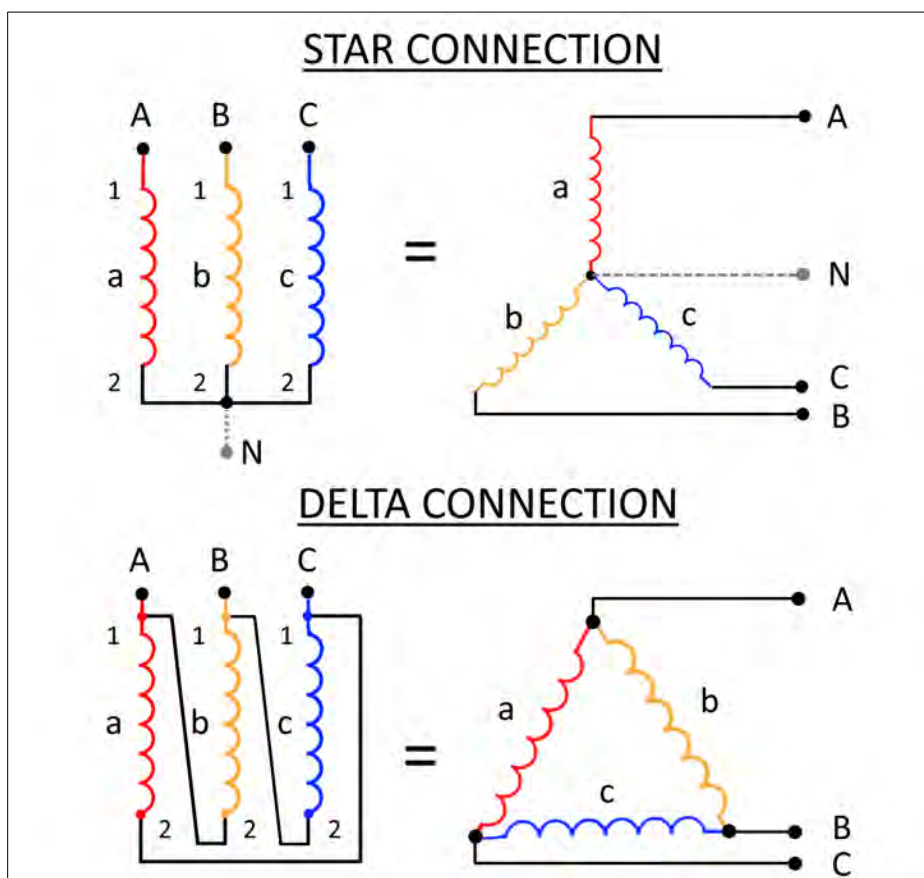

Figure 5-15: Three Phase AC Star versus Delta Connections

Note that in AC Voltage source mode, the AZX can be connected to either a Wye or Delta three phase load without requiring isolated neutrals. For electronic Load or Current Source modes however, this will not work. The following conditions apply:

- AZX (load) in star + UUT (source) in star WORKS (with neutral connection to the AZX)
- AZX (load) in star + UUT (source) in delta DOES NOT WORK. Requires W option + delta connection in AZX
- AZX-W (load) in delta + UUT (source) in delta WORKS

- AZX-W (load) in delta + UUT (source) in star (no neutral connection) WORKS

Using an AZX with W option, you can make a star or delta connection, but with a standard AZX, only a star connection is possible because all Neutrals shorted together inside.

The following connections are supported with the W option:

Star output with standard AZX (Na, Nb, Nc are shorted inside unit), used connects only one neutral or all 3 neutrals, depending on the neutral current level:

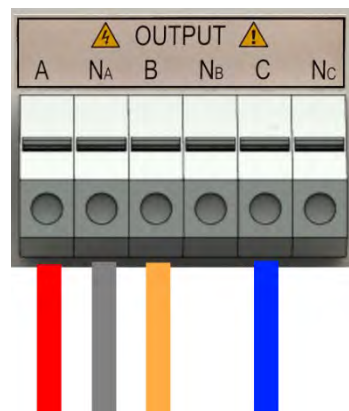

Star output with “Option W” AZX (Na, Nb, Nc have to be shorted outside unit, either at terminal block or somewhere else):

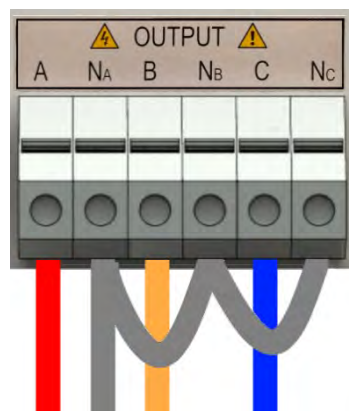

Delta output with “W Option” AZX:

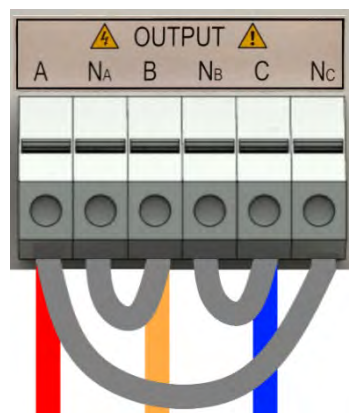

5.13.7 Single Phase Load Output Connection

Connection of a single phase or DC load can be accomplished by using a power splicer terminal block like the one shown here may be used. Example of suitable splicer block is Marathon P/N 1452579, 600V, 380A.

Note Splicer terminal blocks like the one shown above are **NOT** included with the power source and must be supplied by the end-user.

Connect AZX output phases A, B and C to the Line connection of the AC load or DC+ side for a DC load. Connect all three-phase output connections to the Neutral connection of the AC load or the DC- side for a DC load. Refer to Figure 5-10 for single-phase mode load connection diagram.

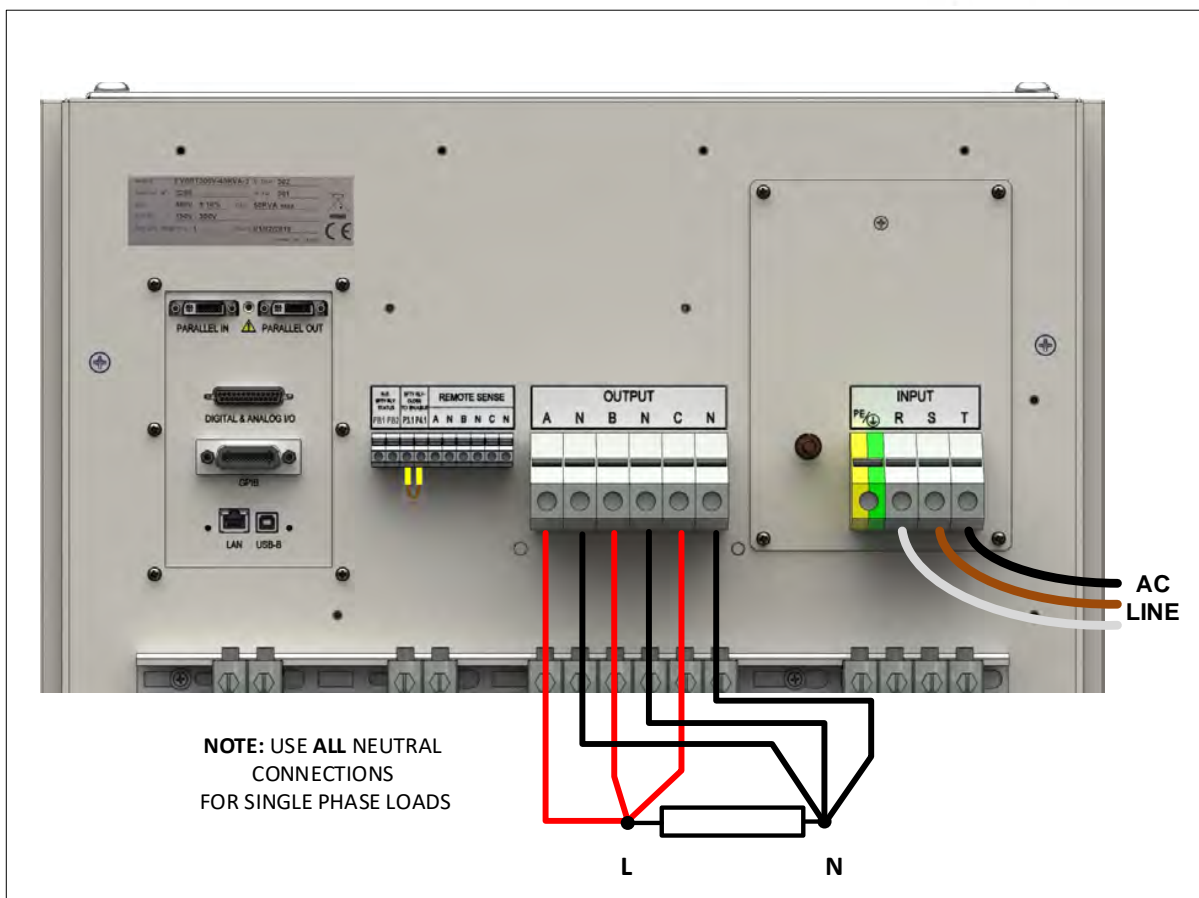

Figure 5-16: Single phase Load Output Connections

Note Load and sense wiring are **NOT** included with the power source and must be supplied by the end-user.

5.13.8 DC Mode with Series Connections (AZX-W only)

AZX models with the -W isolated neutral option may be used for higher DC voltage applications by using the AZX-W in three phase mode and connecting the three outputs in series.

Note: This requires the W option and **cannot** be done with a standard AZX model.

Care must be taken however that the maximum output voltage of any of the three outputs (phases) does not exceed the maximum isolation voltage rating of the AZX which is 1000V.

For split phase (dual) DC output applications, this can be accomplished by connecting the neutral to ground so neither of the two DC outputs ever exceeds $\pm 650V_{dc}$.

For a three-phase series output application as described in this section, there is no ‘center’ neutral output as there are three DC supplies in series connections (A, B, C) and three neutral outputs (Na, Nb, Nc). To ensure the 1000Vdc safety limit is not exceeded, the following output arrangement and connections should be used:

- phA-OUT (A): output positive
- phA-N (Na): to phB-OUT (B)
- phB-OUT (B): to phA-N (Na)
- phB-N (Nb): to phC-OUT (Nc) and earth
- phC-OUT (C): to phB-N (Nv) and earth
- phC-N (Nc): output negative

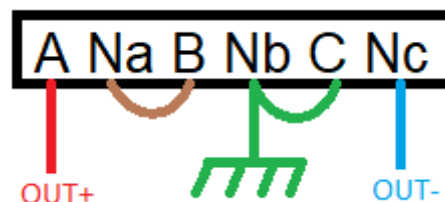
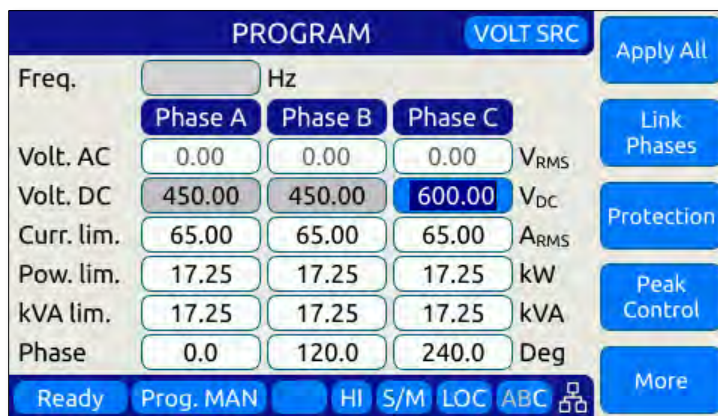

Figure 5-17: DC Output Series Connection on AZX-W

This is illustrated in the diagram to the right.

Using this connection diagram, program Phase C to +600Vdc and A and B to +450Vdc each, the output will be + 900V / - 600V, leaving a 100 V safety margin for the common mode voltage of the A output. The EUT will see the required 1500Vdc between output (phase) A and C.



Note: It is recommended that **phA** is kept at the **highest potential** to earth because that phase has common mode voltage protection. So if the 1000V are exceeded in any of the output terminals of phA, the unit shuts down. Phase B and C do not have CM voltage protection due to the W option.

5.13.9 External Voltage Sense Connections



WARNING

HAZARDOUS OUTPUT: The power source output may be set to hazardous voltage levels. It provides basic isolation from the ac input mains. Therefore, the external voltage sense must also always be considered hazardous. Connections must be inaccessible to operator in all situations when ac input mains voltage is applied.

Always disconnect power supply from the mains before connecting or disconnecting to the hazardous external voltage sense terminals.

Note Load and sense wiring are **NOT** included with the power source and must be supplied by the end-user.



AVERTISSEMENT

SORTIE DANGEREUSE: La sortie de l'appareil peut être réglée à des niveaux de tension dangereux. L'appareil fournit une isolation de base du réseau d'entrée AC. Par conséquent, les connexions de sense externes doivent toujours être considérées comme dangereuses. Les connexions doivent être inaccessibles à l'opérateur dans toutes les situations où la tension d'entrée secteur est appliquée.

Toujours débrancher l'alimentation secteur avant de connecter ou déconnecter les bornes de connexions de sense externes.

When the external voltage sense lines are disconnected, the sensing circuit trips a sensing fault right after the protection trip time. The protection trip time is configured on the protections section and by default is 500ms. The protection is based on RMS values, so at least it takes 100ms to trip.

The protection trips if the following condition is fulfilled during a time equal to the protection trip time:

$$\text{ABS}(\text{VOLTAGE_SETPOINT_RMS} - \text{VOLTAGE_MEASUREMENT_RMS}) > \text{MAX}(\text{SENSe:FAULT:LEVel:PERcentage} * \text{VOLTAGE_SETPOINT_RMS}, \text{SENSe:FAULT:LEVel:MIN})$$

By default SENSE:FAULT:LEVel:PERcentage is 10% and SENSE:FAULT:LEVel:MIN is 25 volts.

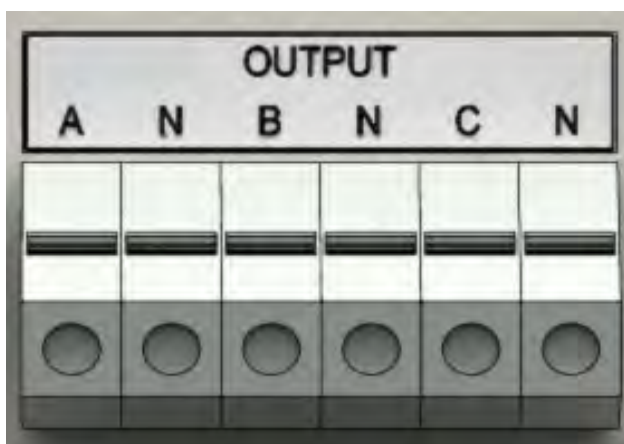

Figure 5-18: External Voltage Sense Connector Signal Connections

When using external voltage sense, sense wires must be connected between the rear panel REMOTE SENSE terminals (A N B N C N) and the load. These wires do not carry any load current so can be sized accordingly.

Note: If the external sense connections are not used and should be left unconnected. When not connected, the power source will automatically use internal voltage sense. In internal voltage sense mode, any voltage drop between the output terminals and the load caused by load wire resistance is not compensated.

For three-phase sense connection wiring, refer to Figure 5-7 for 3 phase WYE load connections and Figure 5-9 for three phase DELTA load connections.

Note The required Load and sense wires are **NOT** included with the power source and must be supplied by the end-user.



Note: **REMOTE INTERLOCK CONNECTION.** To enable the AC input, the Remote Interlock connector pins P3.1 and P4.1 **MUST** be shorted together. If no interlock is required, a shorting wire can be installed as shown above. If an interlock safety connection is required, connect P3.1 and P4.1 to a suitable remote safety shutdown switch.

Note that restarting the AZX after a safety shutdown can only be done from the front panel.

5.13.10 FB1 and FB2 Connections

These terminals may be used to monitor the Output Relay Status of the power source.

5.13.11 Powering Up

The following procedure should be followed before applying mains power:

1. Check that the front panel circuit breaker is in the OFF (O) position.
2. Verify that the model nameplate AC input specification match the local utility power.

3. Make sure that nothing is connected to any of the OUTPUT terminals on the rear panel.
4. Connect the correct AC mains line to the AZX Series® AC input terminal using a suitable three phase AC mains disconnect switch.
5. Close the AC mains disconnect to apply utility power.
6. Turn on the front panel circuit breaker by pulling the lever upward to the “I” position.
Note: Allow about 25 seconds for the AZX unit to fully initialize.
7. If the instrument does not turn on for some reason, turn OFF the front panel circuit breaker and verify the presence of the correct AC line input voltage using appropriate safety measures.

5.13.12 In Case of Malfunction

In the unlikely event of an instrument malfunction or if the instrument does not turn on despite the presence of the correct AC line voltage, please attach a warning tag to the instrument to identify such to the owner or any possible user of the equipment and indicate that service or repair is required. Refer to section 5.4.7, “Safety Circuits Status Monitor” on page 74 first. If problem persists, contact Pacific Power Source or its authorized representative to arrange for service.

5.14 Parallel Cabinets System Installation

Two or more AZX units can be configured as a parallel system to create a higher power system. This requires at least one Master AZX cabinet and one or more Auxiliary cabinet or Master cabinet that will be used as Auxiliaries to the first Master.

Only the first Master unit on the system bus will have an active front panel. All other AZX cabinets will display the fact that they are operating in Auxiliary mode with an inactive front panel. No re-configuration is of a Master cabinet used in an auxiliary position is required.

Note: Master cabinets used in an auxiliary paralleled position can be different models as in a 30kVA/kW 3300AZX can be paralleled with a 50kVA/kW 3550AZX. In this case, each unit delivers its rated current and power current /power into the load.

Dual Units	Total Power	Three Units	Total Power	Four Units	Total Power
30 / 30	60 kVA/ 60 kW	30 / 30 / 30	90 kVA/90 kW	30 / 30 / 30 / 30	120 kVA/120 kW
50 / 30	80 kVA/ 80 kW	50 / 30 / 30	110 kVA/110 kW	50 / 30 / 30 / 30	140 kVA/140 kW
50 / 50	100 kVA/100 kW	50 / 50 / 30	130 kVA/130 kW	50 / 50 / 30 / 30	160 kVA/160 kW
		50 / 50 / 50	150 kVA/150 kW	50 / 50 / 50 / 30	180 kVA/180 kW
				50 / 50 / 50 / 50	200 kVA/200 kW

Table 5-3: Parallel Configurations of up to four AZX units

5.14.1 Load Connections on Parallel Systems

Paralleling two or more cabinets requires that their outputs are tied together using equal length load cables from each cabinet to the load. A common coupling terminal block may be used to combine outputs in combination with larger size load wires to the load. Make sure

the appropriate size wiring is used for the higher current levels obtained by paralleling two or more cabinets.

5.14.2 Parallel System Bus Connection

For both units to operate correctly, the system bus connections between the master and auxiliary units **MUST** be made. This is done by daisy chaining the master to the first auxiliary and that auxiliary to the next one.

The system interface connectors are located on the left hand side of the rear panel and marked as follows:

PARALLEL IN On the MASTER unit, this connector is **NOT CONNECTED**. This causes the unit to become a master for other parallel units at power on. On an AUX unit, this connector is connected to a MASTER unit or an AUX unit that precedes this unit in the parallel chain.

PARALLEL OUT On the MASTER unit, this connector is connected to the first AUX unit. On the last AUX unit in the parallel chain, this connector is **NOT CONNECTED** signifying the end of the parallel chain.



The system bus uses a DVI-I Dual Link Male to Male interconnect cable with noise suppression ferrite beads. Cable length for paralleling cabinets with no more than 1U space between units is 3 feet (1 m). Use of longer cables is not recommended.

An example of the interconnects between one MASTER and one AUX is shown in the figure below.

Note: Any unused Parallel bus connector must be covered by the included safety covers.

Note AC input, AC Load and sense wiring are **NOT** included with the power source and must be supplied by the end-user.

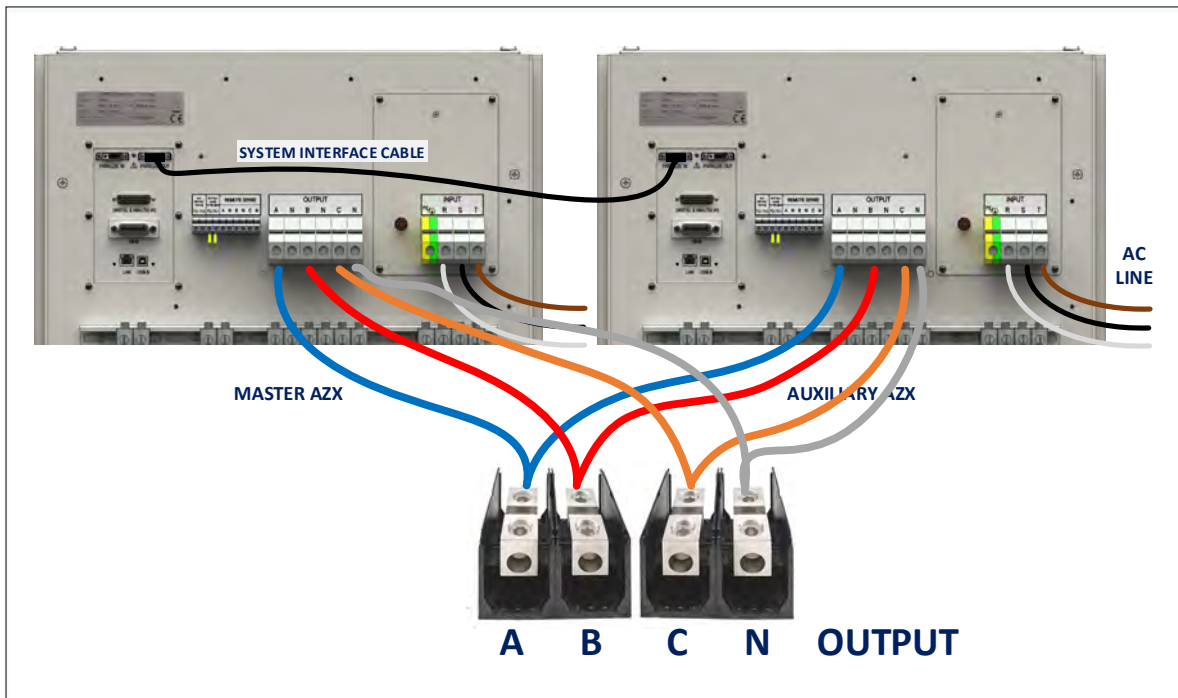

Figure 5-19: Parallel Mode Bus Connections using parallel bus cable

5.15 Interface Options

All AZX Series® models supports four remote control interface options; USB, LAN, GPIB and RS232. All remote control interface connectors are located at the rear panel as shown in the illustration below.

5.15.1 Rear Panel Interface Connector Locations

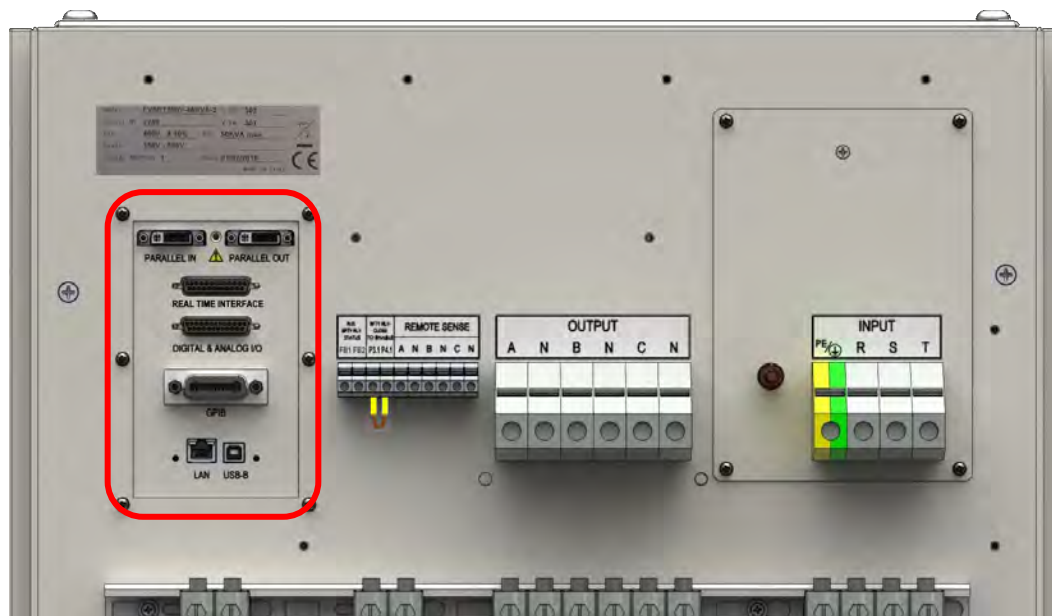

Figure 5-20: Remote Control Interface Connector Locations on Rear Panel

5.15.2 USB Device Interface

The USB DEVICE interface (USB Type B connector on the rear panel) provides a virtual COM port for the PC. Via this port, the unit can be controlled as a normal RS232 interface, e. g. with a terminal program or user application program. Refer to the section 9, “USB Driver Installation” for further setup and configuration information.

Refer to the section 9, “USB Driver Installation” for further setup and configuration information.

5.15.3 RS232 Serial Interface

The RS232 serial interface of the AZX Series is incorporated in the DB25 Auxiliary I/O connector located on the rear panel. Refer to section 7.3, “Auxiliary I/O” on page 220 for details. Do not use standard DB9 to DB25 adaptors or cables to connect to the RS232 serial interface. The connections shown in table below **MUST** be used.

PIN	Abbreviation	Description
Pin 1	RXD	RS232 I/F – Receive Data
Pin 2	GND	GND
Pin 14	TXD	RS232 I/F – Transmit Data

Table 5-4: RS232 DB25 Tx and Rx Pin Locations

5.15.4 GPIB Device Interface

The GPIB interface uses the IEEE488.1 standard 24-pin D-Shell Amphenol micro ribbon connector. Using a standard GPIB cable, the cable will break out to the left of the unit when facing the rear. This will typically obstruct USB and LAN interface connector access. Reverse GPIB cables are available but using these will obstruct the Auxiliary I/O connector.

The GPIB pin assignments are per the IEEE488.1 standard and listed in the table below.

PIN	Signal	Description
Pin 1	DIO1	Data input/output bit.
Pin 2	DIO2	Data input/output bit.
Pin 3	DIO3	Data input/output bit.
Pin 4	DIO4	Data input/output bit.
Pin 5	EOI	End-of-identify.
Pin 6	DAV	Data valid.
Pin 7	NRFD	Not ready for data.
Pin 8	NDAC	Not data accepted.
Pin 9	IFC	Interface clear.
Pin 10	SRQ	Service request.
Pin 11	ATN	Attention.
Pin 12	SHIELD	
Pin 13	DIO5	Data input/output bit.
Pin 14	DIO6	Data input/output bit.
Pin 15	DIO7	Data input/output bit.
Pin 16	DIO8	Data input/output bit.
Pin 17	REN	Remote enable.
Pin 18	GND	(wire twisted with DAV)
Pin 19	GND	(wire twisted with NRFD)
Pin 20	GND	(wire twisted with NDAC)
Pin 21	GND	(wire twisted with IFC)
Pin 22	GND	(wire twisted with SRQ)
Pin 23	GND	(wire twisted with ATN)
Pin 24	Logic ground	

Table 5-5: GPIB Interface Connector Pin Assignments

5.15.5 LAN Interface

The LAN interface connector is installed on the rear panel. The MAC address of the unit can be found near the LAN connector.

No special device drivers are required to use the LAN interface as it uses TCP/IP protocol but the IP address needs to be configured to operate on the user's local area network or private network.

6 Front Panel Operation

This Chapter provides an overview of front panel operation for the AZX Series® AC power sources. For remote control operation, refer to Section 8 “Remote Control Programming” of this manual for an overview of available programming commands.

6.1 Front Panel Layout

The front panel layout is shown in Figure 6-1 below. The number of buttons is kept to a minimum to ensure simple front panel operation for casual and experienced users alike. The shuttle knob is used to slew parameter values and move through menus to make selections.

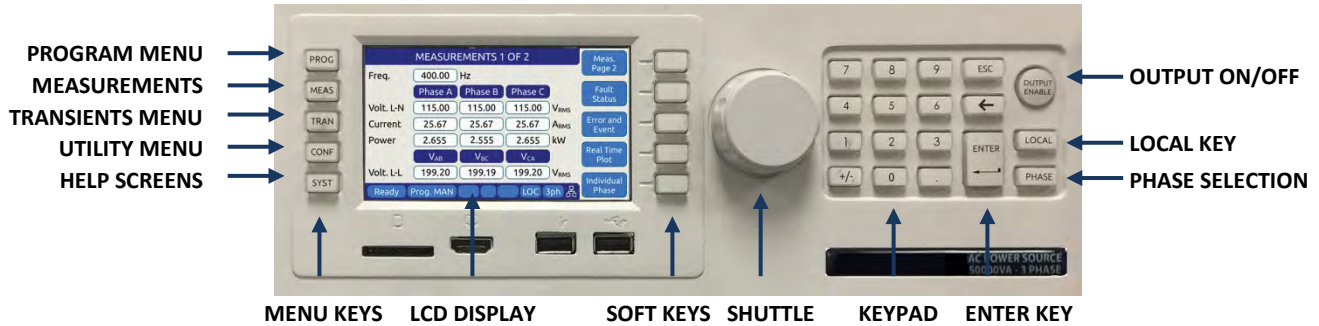

Figure 6-1: AZX Series® Front Panel View

A large backlit LCD display is located in the center. Most user controls are located directly to the right of the display.

6.1.1 Keyboard Buttons

There are several groupings of push buttons that make up the front panel. They are grouped as follows:



Group	Function
Menu Selection Keys	These keys select the available top-level menus. Sub menus may be accessible using any of the available soft keys within each top-level menu.
Soft Keys	Soft keys change function as indicated by the decal directly to the left of the soft key on the LCD display.
Shuttle	See next section for details on shuttle operation.
Decimal Key Pad	The decimal key pad is used to enter parameter values directly. Values may also be set using any available soft key or the shuttle.
ENTER Key	The ENTER key confirms a selection or setting made with the decimal key pad. Until confirmed by pressing the ENTER key, selections and values will be shown grayed out on the LCD display to indicate they have been edited/changed but have not yet taken effect. This allows multiple parameters in the same screen to be edited with all new setting values taking effect at once when the ENTER or UPDATE ALL soft key is pressed.
ESC Key	The escape key backs out of a menu or selection and returns to a previous level.
Back Space Key (←)	This key backs up one position erasing the last digit value entered.
OUTPUT ENABLE	The OUTPUT ENABLE key is used to toggle the output on (Green) or off (Blue). If the output is ON, this key will be lit. When alternating between green and blue colors, there is one or more error message in the E&E queue.
LOCAL	Returns the instrument to local control mode allowing front panel operation. This key may be disabled over one of the remote control interfaces. While in REMOTE, the keyboard is locked out. The LOCAL key can also be used to capture and LCD Image and store it as a .png image file in internal memory. To do so press and hold the LOCAL key, then press the 1 key. Screen images are saved in folder "internal/screenshots".
PHASE	The PHASE key is used to select a specific phase, A, B or C or all phases (ABC).

6.1.2 Shuttle Knob

The shuttle knob or rotary digital encoder is used to navigate (scroll) through menus and select fields to modify settings. The shuttle knob also includes a SELECT push button function. Pushing in the shuttle knob (SELECT) while on a data field will allow the value to be slewed up or down.

NOTE: Unlike when using the decimal keypad to enter a value, the SELECT shuttle mode will cause the output to change immediately. This allows slewing of the actual output value.

Once the final value is reached, pressing the shuttle again will take it out of slew mode and back into scroll mode.

6.1.3 PC Monitor Output

A PC monitor output connector is located below the LCD on the front panel. This connector is marked with a monitor icon as shown here. This allows connection of a computer monitor. When connected, the monitor will display the information otherwise shown on the front panel LCD screen and the LCD screen itself will be off.



This feature allows for the connection of a touch enabled LCD monitor to the Video Output the front panel as well. When detected by the AZX, a message will pop-up asking the operator to change to the external screen. If accepted, the front panel LCD will turn off and the AZX screen will be display on the monitor along with a touch panel to operate the unit. The actual front panel keypad will remain active as well. This feature is useful for operator training or in control rooms where being able to read the measurement screen from across the room is required. A USB connection to one of the AZX USB ports is required to use the monitor's touch feature.

To return the display to the LCD screen, unplug the monitor.

6.1.4 USB Host Ports

Two USB host ports are located directly below the LCD display on the front panel. These ports will accept a USB memory device or a USB peripheral such as a mouse or keyboard. These USB ports are marked with the standard USB symbol as shown here.



6.1.5 SD Card Memory Slot

A SD Card memory device slot is located directly below the LCD display on the front panel. This slot will accept a standard SD memory card. The SD Card slot is marked with the symbol shown to the right here.

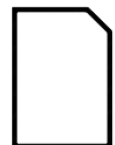

6.2 OUTPUT ENABLE Button

The circular Output Enable (On/Off) button is located on the right hand side of the front panel keypad. Its unique circular shape makes it easy to find so the output can be turned off quickly if needed.

The state of the output is indicated by the back light color of the Output On/Off button. A blue color indicates the output is OFF, a green color indicates the output is ON. Alternating Green and Blue color indicates there is one or more error messages in the E&E queue.

6.3 Menu Keys

The various menus and settings available to the user from the front panel are detailed in this section of the manual.

All available menus can be accessed using the Menu keys to the left of the LCD display. The following five keys are available.

MENU KEY	MENU SCREEN	Description
PROG	PROGRAM	Programming of output parameters
MEAS	MEASUREMENTS	Measurements
TRAN	TRANSIENTS	Transient programming and execution
CONF	CONFIGURATION	Configuration Screens
SYST	SYSTEM	System Settings, Interface Configuration and Calibration

Table 6-1: Available Menu Keys

Following sections cover each aspect of the front panel screen and parameters in more detail.

6.4 PROG – PROGRAM Screens

All output parameters can set from the PROGRAM screen. This screen has a list of available parameters on the main PROGRAM screen. Each parameter can be changed by highlighting the field and either slewing the value using the shuttle knob or entering a value using the numeric key pad. The difference between these two data entry modes is that slewing causes the output to change as the knob is turned while using the keypad allows one or more parameters to be preset to a new value which won't become active until the "Apply All" soft key or the ENTER key is pressed.

Thus to slew a value, proceed as follows:

1. Use shuttle to move the active field to the parameter you want to slew.
2. Press the shuttle once to enter the slew mode. The selected field will be highlighted.
3. Use the shuttle to increment (*clockwise*) or decrement (*counterclockwise*) the selected parameter. Note that these changes take effect immediately resulting in the active output slewing up or down.

Note: This assumes the output is ON. If the output is OFF, the new value will be in effect and apply at the output as soon as the output is turned ON.

To slew a parameter while observing the MEASUREMENT screen, proceed as follows:

1. Use shuttle to move the selected field to the parameter you want to change.
2. While on the desired parameter (e.g. Voltage or Frequency), DOUBLE-PRESS the shuttle (similar to double clicking a mouse button).
3. The MEASUREMENT screen will appear with the parameter to be slewed visible in the header bar.
4. Use the Shuttle to slew the parameter up or down. The value will be displayed in the header bar of the measurement menu.
5. When done, press the PROGRAM key to return to the regular PROGRAM screen and exit this interactive mode.

With the parameter field selected, enter a new value using the numeric keypad.

To change one or more values but not change the actual output till all parameters are preset, proceed as follows:

1. Use shuttle to move the selected field to the parameter you want to change.
2. With the parameter field selected, enter a new value using the numeric keypad. Note that all fields are now shown with a gray background (Edit mode active)
3. Once satisfied with the new value, move to the next parameter you want to change.
4. Once all values are set to the new desired set value, press the ENTER key or the "Apply All" soft key.

Note: Actual Program screen content will vary with the selected mode of operation between Voltage Source, Current Source or Active Load modes.

6.4.1 Power On Settings

The AZX Series will normally power up with the last settings in effect at turn-off

This behavior is determined by the “SOURce:INITial” command. This feature is active by default. This makes the AZX “remember” all the settings after cycling power.

This mode can be disabled by using the remote control command:

SOURce:INITial 0

This setting is retained in non-volatile (FLASH) memory.

6.4.2 PROGRAM Parameters – Voltage Source Mode



Figure 6-2: PROGRAM Screen - Voltage Source Mode

The Change Style (SK1) soft key toggles the PROGRAM Screen to a combination Setting and Measurement screen as shown below (example with Current Mode selected).

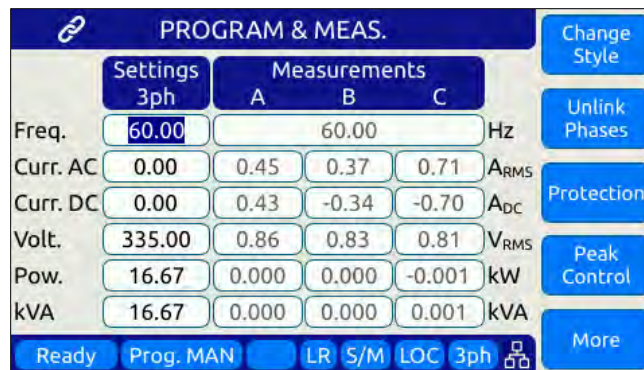

This mode only applies when all phases are LINKED as there is only one column for changing settings (Column 1). The Measurements are updated continuously.

The two data entry methods described apply to the parameters on the main PROGRAM screen. This includes those shown in the table below.

PARAMETER	Range	Unit	Description
Frequency	15 - 1000	Hz	Output frequency
Phase	0.0 – 359.0	Degrees	Phase angles for phase B and C Voltage
Voltage AC	0 – 440	V rms	AC output
Voltage DC	0 - 650	Vdc	DC output
Current limit	0 to Max	A rms	RMS Current Limit
Power limit	0 to Max	W	True Power Limit
kVA limit	0 to Max	VA	Apparent Power Limit

Table 6-2: Available Voltage Source Mode Parameters on PROGRAM screen

Each screen has up to five soft keys on the right-hand side of the display. These may change as the selected parameter changes. To move between parameter fields in any screen, use the shuttle knob. To change a parameter, press the shuttle knob and then adjust the value by turning the shuttle. When done, press the shuttle to exit edit mode.

There are three program screens like this, each with some different soft keys. To access the second and third program screen, use the More (SK3) soft key on the left side of each screen. This will toggle through the three available PROGRAM screens.



PROGRAM screen two allows access to the Protection and Peak Control screens.



Note: The same Program screens and soft keys are available in Current Source Mode or in Programmable Load mode.

6.4.3 PROGRAM Parameters – Current Source Mode



Figure 6-3: PROGRAM Screens Current Source Mode

The Current Source Mode functions in much the same way as the Voltage Source mode, except for:

- The current is now a set point, not a protection limit
- The Voltage setting is now a protection level.
- The peak voltage protection becomes a level only protection.
- The peak current becomes a level and/or margin protection.
- Slew rates and transient programming now applies to current iso voltage settings.

The two data entry methods described apply to the parameters on the main PROGRAM screen. This includes those shown in the table below.

PARAMETER	Range	Unit	Description
Frequency	15 - 1000	Hz	Output frequency
Curr. AC	0 – ± 440	Arms	AC current set point ¹ .
Curr. DC	0 - ± 650	Adc	DC current set point ¹
Volt. limit	0 to Max	Vrms	RMS Voltage Input Limit
Pow. limit	0 to Max	W	True Power Limit
kVA limit	0 to Max	VA	Apparent Power Limit
Phase	0.0 – 359.0	Degrees	Phase angles for phase B and C Current

Table 6-3: Available Current Source Mode Parameters on PROGRAM screen

Each screen has up to five soft keys on the right hand side of the display. These may change as the selected parameter changes. To move between parameter fields in any screen, use the shuttle knob. To change a parameter, press the shuttle knob and then adjust the value by turning the shuttle. When done, press the shuttle to exit edit mode.

¹ Negative current settings apply in Current Source & Active Load modes only and indicate sinking of current (Regen).

6.4.4 PROGRAM Parameters – Load Mode Option

The LOAD mode is an optional feature. If the Load option is not installed, these screens will not be visible and you can skip this section of the manual. The Load mode is described in more detail section 3.7 on page 29. This section covers the front panel PROGRAM screens for each of the four Load operating modes.

There are four distinct Load operating modes that are selectable. The load mode can be set from the UNIT CONFIGURATION screen available from the CONF key. The four modes are shown in the screens below.

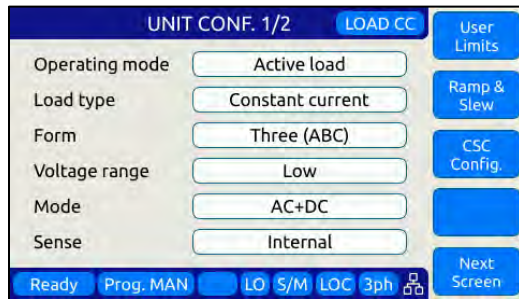

Constant current mode

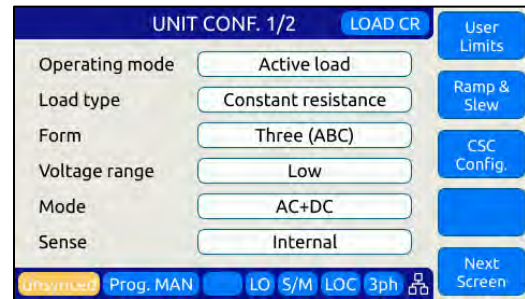

Constant resistance mode

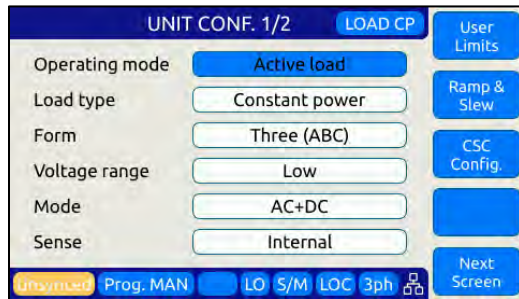

Constant Power mode

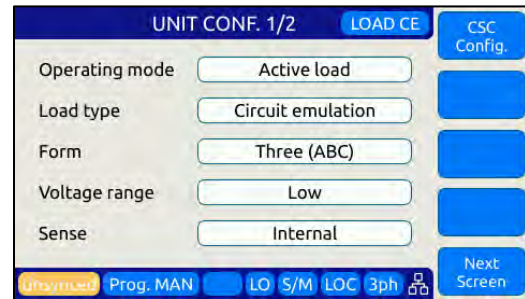

Circuit Emulation mode

Front panel operation for each Load mode is covered in the following four sections in the order shown above.

6.4.4.1 Constant Current Mode Program Screens

To operate the unit in Load mode, press the CONF menu key and set the Operating mode to “Active load” as shown below. Then set the Load type field to “Constant Current”. This enables the constant current load mode. Sinking current and power is achieved by entering negative set values for current settings and power limits.

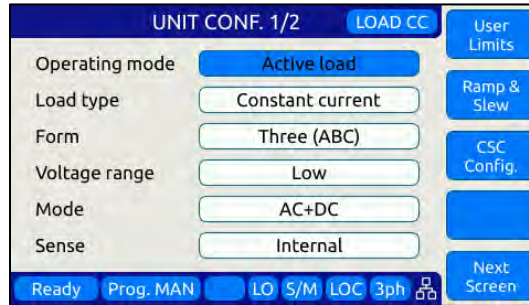

Next Press the PROG menu key to display the PROGRAM screen. The mode indicator in the upper right corner will show “LOAD CC” to indicate the operating mode.

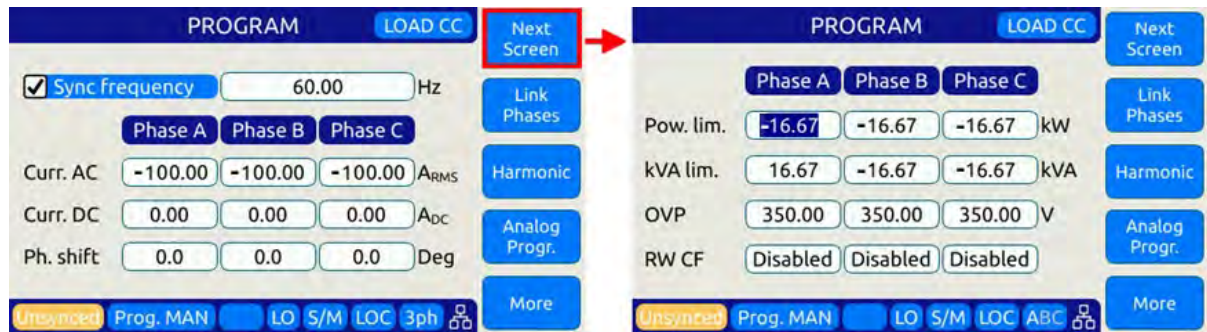

Figure 6-4: PROGRAM Screens Constant Current Load Mode

In CC mode there are two PROGRAM screens as shown above. This first one allows programming of the AC and/or DC current to be drawn from the EUT as well as the phase angle of the AC current with respect to the AC input voltage from the EUT.

Press the Next Soft key to select the second screen to set Power and VA limits and OVP trip levels for each phase. The number of phases displayed is a function of the selected phase mode, one phase, split phase, or three-phase.

The available setting parameters in this load mode are shown in the table below.

PARAMETER	Range	Unit	Description
Sync freq.	15 - 1000	Hz	Expected Load input Frequency
Curr. AC	0 – ± 130	A rms	Max AC current sink depends on selected range ² .
Curr DC	0 – ± 100	Adc	Max DC current sink depends on selected range ²

² Sum of AC peak + DC Current cannot exceed max rating of unit. Negative value indicates sinking current.

PARAMETER	Range	Unit	Description
Phase Shift	0 – 359.9	Degrees	Phase angle between input AC voltage and AC load current
Pow. limit	0 to ± Max	W	True Power Limit
kVA limit	0 to ± Max	VA	Apparent Power Limit
OVP.	0 to Max	Vpk	Maximum Input Voltage Peak limit
RW CF	Enabled/Disabled		Rectifier Waveform Crest Factor

Table 6-4: Available Load CC Setting Parameters on PROGRAM screen

Each screen has up to five soft keys on the right-hand side of the display. These may change as the selected parameter changes. To move between parameter fields in any screen, use the shuttle knob. To change a parameter, press the shuttle knob and then adjust the value by turning the shuttle. When done, press the shuttle to exit edit mode.

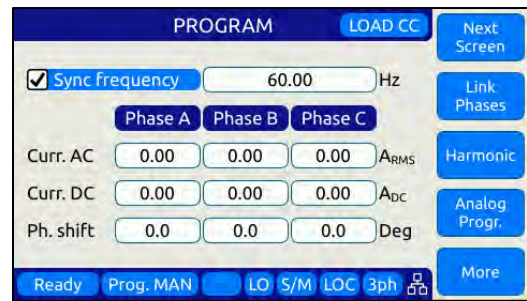

The following soft keys are available in the Load Program screens:

- Waveform** Allows selection of standard or custom waveforms
- Interharmonic** Allows programming of an interharmonics amplitude and frequency for current in Current Source or Load modes.
- Harmonic** Allows programming of up to five regulated harmonics for current in Current Source or Load modes
- Analog Progr.** Allows programming of Analog input functions.

Note: See section 6.4.4.3, “Active Load Sync Operation and Crest Factor Settings” on page 124 for Crest Factor Current modes.

6.4.4.2 Constant Resistance Mode Program Screens

To operate the unit in Load mode, press the CONF menu key and set the Operating mode to “Active load” as shown below. Then set the Load type field to “Constant Resistance”. This enable the constant current load mode.

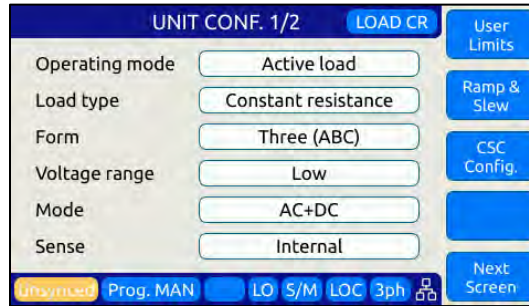

Next Press the PROG meny key to display the PROGRAM screen. The mode indicator in the upper right corner will show “LOAD CR” to indicate the operating mode.

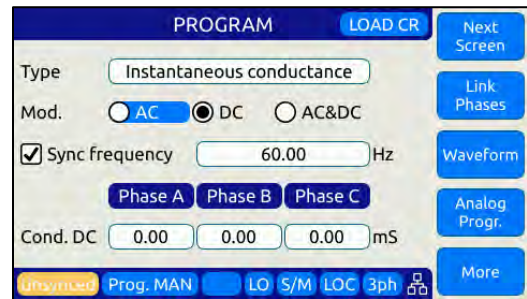
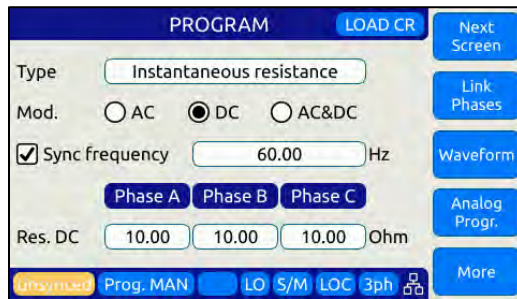
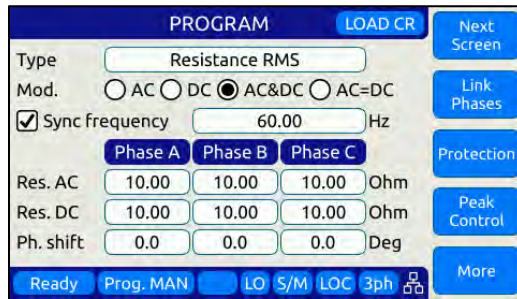

The PROGRAM screens allows selection of four different CR Load Types:

- Resistance RMS
- Conducatece RMS
- Instantaneous Resistance
- Instantaneous Conducatece

The second screen available by pressing the Next Screen Soft key is the same for all four CR models and is shown below.



All four primacy CR Mode program screens offer similar parameters but two operate in RMS mode while the other two operate in instantaneous mode. This latter mode causes the current to track the Voltage waveform.

Press the Next Soft key to selected the second screen to set Current, Power and VA limits and OVP trip levels for each phase. The number of phases displayed is a function of the selected phase mode, one phase, split phase or three-phase. The second program screen also allows the user to set the maximum current slew rate in A/usec.

The available setting parameters in this load mode are shown in the table below.

PARAMETER	Range	Unit	Description
Type	Resistance RMS Conductance		Resistance or Conductance mode
Modulation	AC, DC, AC &DC or AC = DC		Separate AC and DC set values. No AC=DC selection for instaneous modes.
Sync freq.	15 - 1000	Hz	Expected Load input Frequency
Res. / Cond. AC	0 - 1000, Infinite	Ohm	AC resistance or conductance
Res. / Cond. DC	0 - 707, Infinite	mS	DC resistance or conductance
Phase Shift	0 – 359.9	Degrees	Phase angle between input AC voltage and AC load current. Applies to RMS CR modes only.
Curr. Limit	0 – 130A	A rms	Range depends on load model and selected voltage range
Pow. limit	0 to Max	W	True Power Limit
kVA limit	0 to Max	VA	Apparent Power Limit
OVP.	0 to Max	Vpk	Maximum Input Voltage Peak limit
Peak Curr. Limit	0 to Max	lpk	Maximum Current Peak limit
Max Curr. Slew	0.001 – 100	A/us	Current slew rate when input voltage changes.
RW CF	Enabled/Disabled		Rectifier Waveform Crest Factor

Table 6-5: Available Load CR Setting Parameters on PROGRAM screen

Each screen has up to five soft keys on the right-hand side of the display. These may change as the selected parameter changes. To move between parameter fields in any screen, use the shuttle knob. To change a parameter, press the shuttle knob and then adjust the value by turning the shuttle. When done, press the shuttle to exit edit mode.



The following soft keys are available in the Load CR Program screens:

Protection

Allows programming of RMS protections for current, power, trip delay, OVP, UVP, OFP and UFP. These settings use three screens as shown below.

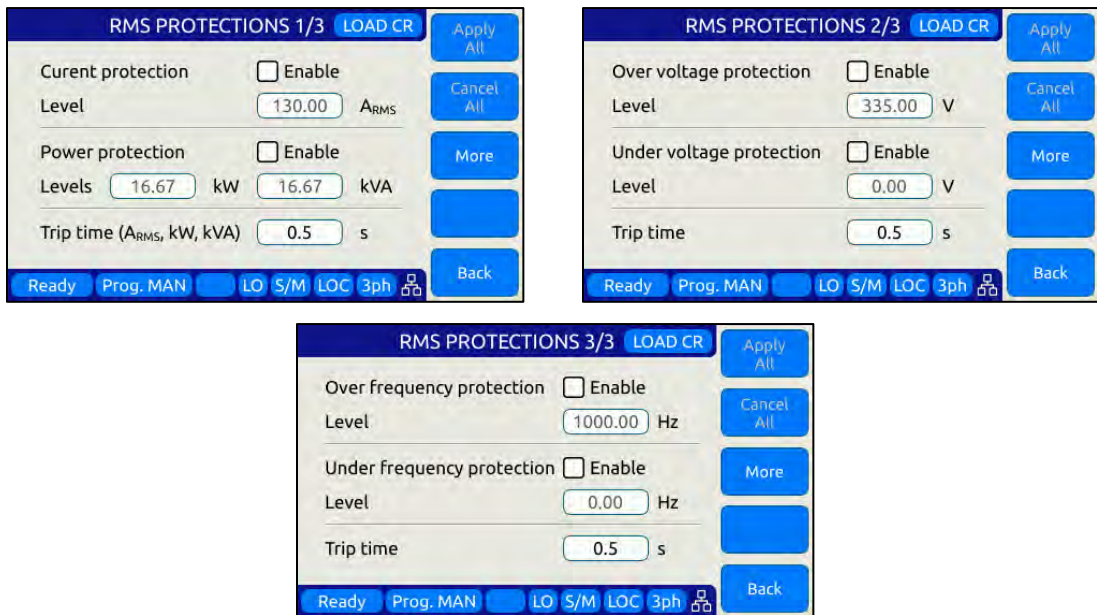

Peak Control

Peak Protection for Voltage, Current and Power.

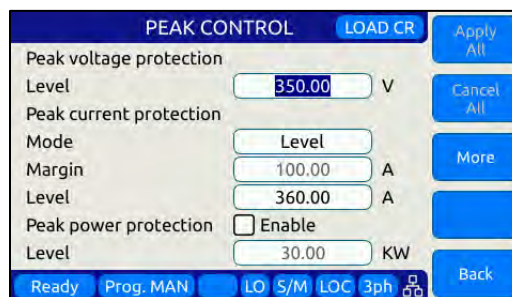

Waveform Allows selection of standard or custom waveforms

Analog Progr. Allows programming of Analog input functions.

Note: See section 6.4.4.3, “Active Load Sync Operation and Crest Factor Settings” on page 124 for Crest Factor Current modes.

6.4.4.1 Constant Power Mode Program Screens

To operate the unit in Load mode, press the CONF menu key and set the Operating mode to “Active load” as shown below. Then set the Load type field to “Constant Power”. This enable the constant current load mode.



Next Press the PROG meny key to display the PROGRAM screen. The mode indicator in the upper right corner will show “LOAD CP” to indicate the operating mode. This mode has two settings:

Apparent Power RMS in kVA

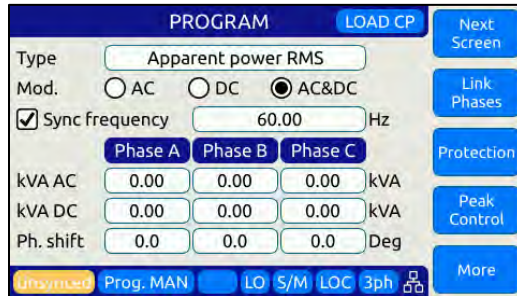

Active Power RMS in kWatt



In each of these CP modes there are two PROGRAM screens as shown above. Both modes support selectable AC, DC or AC & DC settings.

Depending on the selected CP Mode, either kVA or kW for AC and DC can be set separately. The last setting on the first CP screen is for the phase angle of the AC current with respect to the AC input voltage from the EUT.

Press the Next Soft key to selected the second screen to set Current, Power and Power or VA limits and OVP trip levels for each phase. The number of phases displayed is a function of the selected phase mode, one phase, split phase or three-phase. The second program screen also allows the user to set the maximum current slew rate in A/usec.

The available setting parameters in this load mode are shown in the table below.

PARAMETER	Range	Unit	Description
Type	Active power Apparent power	VA or W	Power mode selection
Modulation	AC, DC, AC &DC or AC = DC		Separate AC and DC set values.
Sync freq.	15 - 1000	Hz	Expected Load input Frequency
KVA / Power AC	0 to Max	kVA or W	Power setting AC
kVA / Power DC	0 to Max	kVA or W	Power setting DC
Phase Shift	0 – 359.9	Degrees	Phase angle between input AC voltage and AC load current
Curr. Limit	0 – 130A	A rms	Range depends on load model and selected voltage range
Pow. / VA Limit	0 to Max	W	True Power Limit
OVP.	0 to Max	Vpk	Maximum Input Voltage Peak limit
Peak Curr. Limit	0 to Max	l _{pk}	Maximum Current Peak limit
Max Curr. Slew	0.001 - 100	A/us	Current slew rate when input voltage changes.
Rec. wave.	Enabled/Disabled		Rectifier Waveform Crest Factor

Table 6-6: Available Load CP Setting Parameters on PROGRAM screen

Each screen has up to five soft keys on the right-hand side of the display. These may change as the selected parameter changes. To move between parameter fields in any screen, use the shuttle knob. To change a parameter, press the shuttle knob and then adjust the value by turning the shuttle. When done, press the shuttle to exit edit mode.

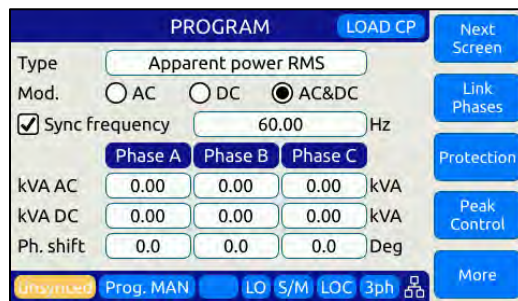

The following soft keys are available in the Load CP Program screens:

Protection Allows programming of RMS protections for current, power, trip delay, OVP, UVP, OFP and UFP. These settings use three screens as shown below.

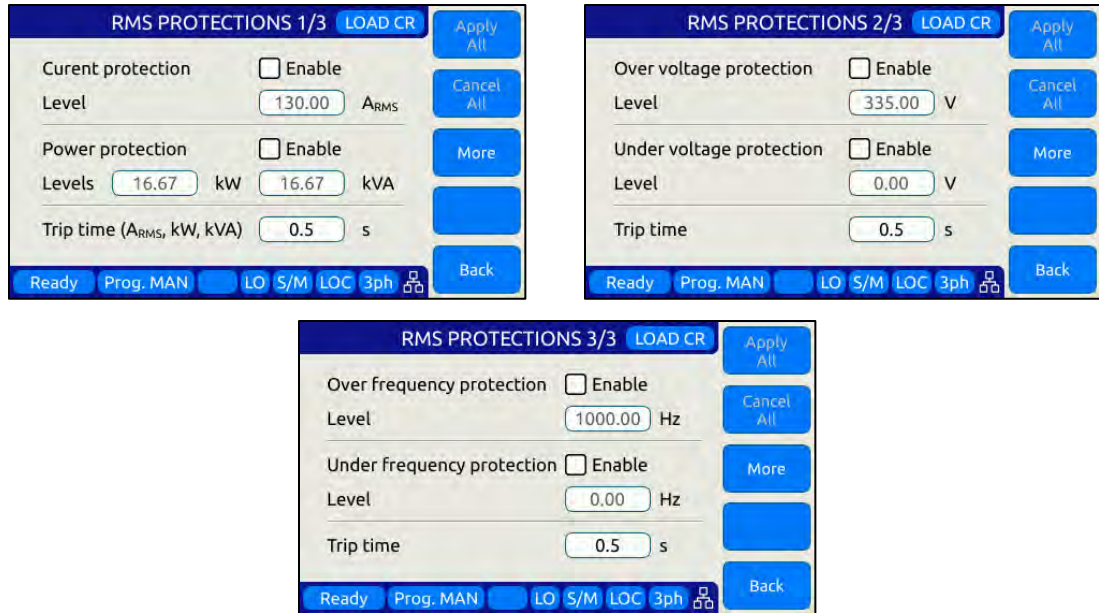

Peak Control Peak Protection for Voltage, Current and Power.

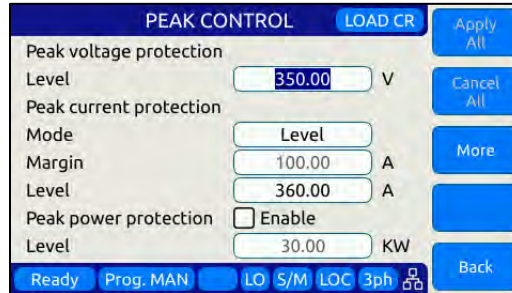

Waveform Allows selection of standard or custom waveforms

Analog Progr. Allows programming of Analog input functions.

Note: See section 6.4.4.3, "Active Load Sync Operation and Crest Factor Settings" on page 124 for Crest Factor Current modes.

6.4.4.2 Circuit Emulation Mode Program Screens

To operate the unit in Load mode, press the CONF menu key and set the Operating mode to “Active load” as shown below. Then set the Load type field to “Circuit Emulation”. This enable the constant current load mode.

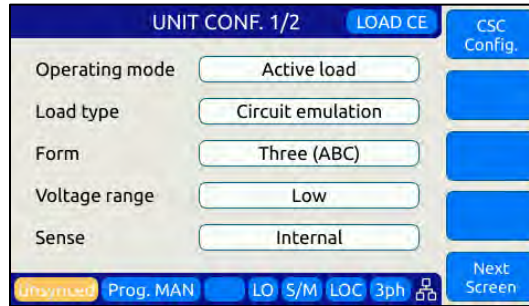

Next Press the PROG meny key to display the PROGRAM screen. The mode indicator in the upper right corner will show “LOAD CE” to indicate the operating mode.

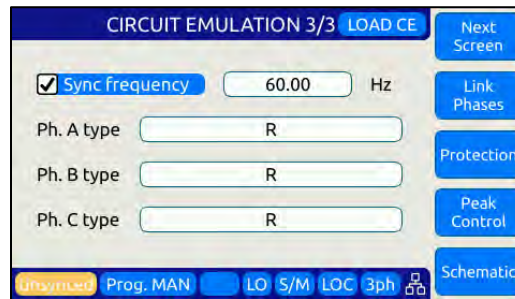
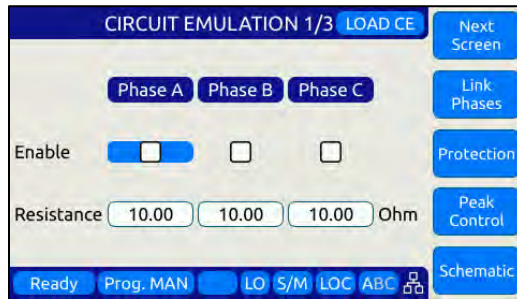

In CE mode there are three PROGRAM screens as shown above. This first one allows phase selection and resistance setting as all circuits emulated have at least one Resistor.

The second CE mode screen allows limit setting just like for CC, CR and CP load modes.

The third CE mode screen allows the specific electrical network to be emulated to be selected for each of three input phases.

The “Schematic” soft key (#5) in the the 1st and 3rd Circuit Emulation Program screen displays the circuit diagram selected for the selected phase. Some samples are shown below but for a complete listing, see section 3.7.4 on page 35.

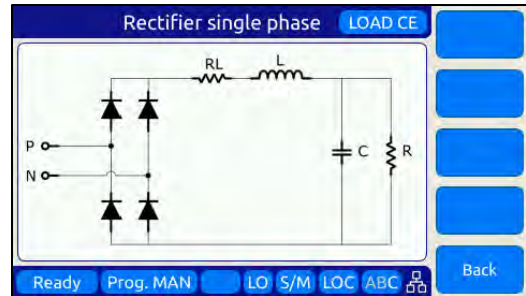
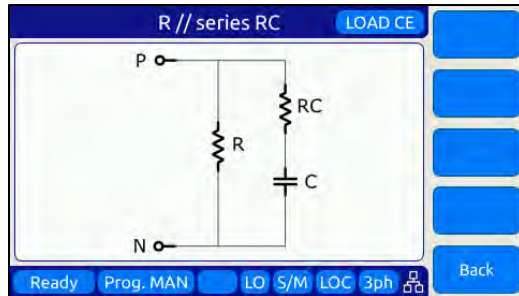

Note that the first Program screen may look different depenednet on what load network is selected for each phase. Simple networks like a resistor require only one parameter while more complex networks may require 2 to 4. In the example below, phase A is set to a Series R L network so phase A parameters set fields visible are R and L only. Phase B is set to a simple R only so only one setting applies to phase B. Finally, phase C uses a more complex network requiring four set values, R, RL and L.

Individual phases can be enabled or disabled in the first (1/3) Program screen.

The following soft keys are available in the Load CE Program screens:

Protection Allows programming of RMS protections for current, power, trip delay, OVP, UVP, OFP and UFP. These settings use three screens as shown below.

RMS PROTECTIONS 3/3		LOAD CR	Apply All
Over frequency protection	<input type="checkbox"/> Enable		Cancel All
Level	<input type="text" value="1000.00"/> Hz		More
Under frequency protection	<input type="checkbox"/> Enable		
Level	<input type="text" value="0.00"/> Hz		
Trip time	<input type="text" value="0.5"/> s		Back
Ready		Prog. MAN	LO S/M LOC 3ph 

Peak Control

Peak Protection for Voltage, Current and Power.

PEAK CONTROL		LOAD CR	Apply All
Peak voltage protection			Cancel All
Level	<input type="text" value="350.00"/> V		More
Peak current protection			
Mode	<input type="text" value="Level"/>		
Margin	<input type="text" value="100.00"/> A		
Level	<input type="text" value="360.00"/> A		
Peak power protection	<input type="checkbox"/> Enable		
Level	<input type="text" value="30.00"/> KW		Back
Ready		Prog. MAN	LO S/M LOC 3ph 

Note: See section 6.4.4.3, “Active Load Sync Operation and Crest Factor Settings” on page 124 for Crest Factor Current modes.

6.4.4.3 Active Load Sync Operation and Crest Factor Settings

In Load mode, the programmed current can be synced to the AC input voltage or the unsynced mode can be selected.

When the SYNC is enabled the unit tries to sync the current with the voltage present at the output. There is a status that indicated in the lower left corner of the display if it is synced or unsynced. The sync frequency control is the center frequency of the PLL and a phase shift that controls the phase shift between the voltage and the generated current. The PLL is able to lock in the full range of frequency, but it will be faster if it is near the output frequency. In SYNC mode, the phase of the current can be shifted with respect to the AC input voltage.

When the SYNC is disabled it is very similar to a current source. It is useful to generate AC+DC current with DC input voltages for example. The frequency and phases can be controlled just as a current source.

Power and KVA limits act at RMS level, behaves as in voltage source.

The OVP is the OVP protection level also available in protections screen. As the voltage is not governed by the unit it is useful to set these as appropriate for the application.

When the rectifier waveform is enabled it will generate a waveform with the desired crest factor. To obtain different power factors the phase shift has to be controlled.

For single phase form the waveform with CF 3 looks like:

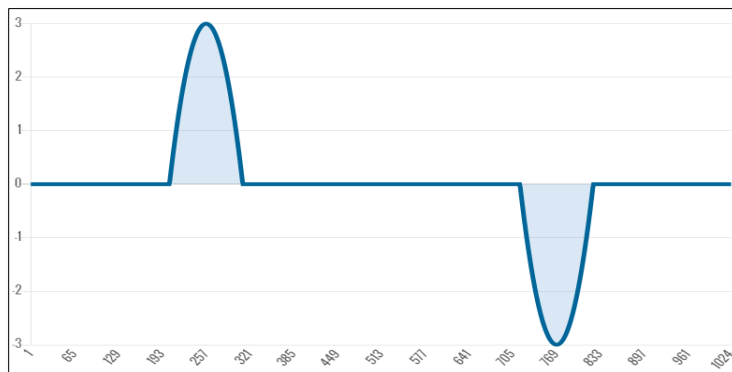

For three phase form the waveform with CF 3 looks like:

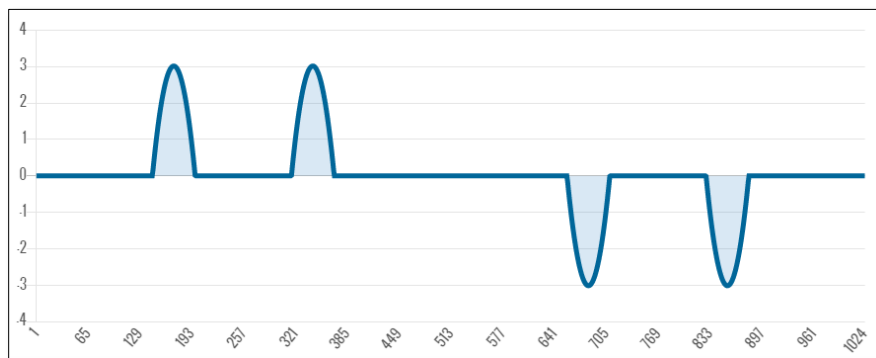

When the rectifier waveform is disabled the waveform is controlled as always. The waveform corresponds to the waveform of the current. Arbitrary waveforms are allowed as well.

6.4.5 Phase Rotation / Phase Sequence

In AC Source mode, Phase rotation (aka sequence) in three-phase mode is determined by the programmed phase angles for phase B and C. Phase A is always the 0° reference and this value can only be changed when an external phase sync. Input mode is used. For normal operation, the internal phase A is used as the phase reference for B and C so phase A is fixed at 0° and the field is disabled. (Light grey instead of black text).

The default phase rotation of the AZX in AC Source mode is the same as that of legacy PPS UPC controllers. This phase rotation is positive so when driving AC motors, the motors will turn forward.

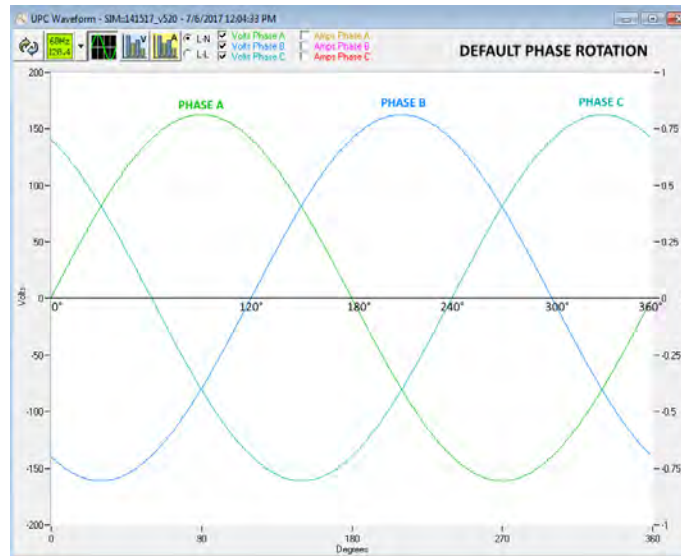

Figure 6-5: Three Phase AC mode Default Phase Rotation

Phase rotation in three-phase mode can be reversed if needed in one of three ways:

1. By swapping output connection wires B (V) and C (W) to the load.
2. By reprogramming the default phase setting for B (V) to 240° and for C (W) to 120°.
3. By selecting “Positive (Phase B leading A)” under “**Phase Rotation**” in the source configuration screen.

The reversed phase rotation is shown in the figure below for reference.

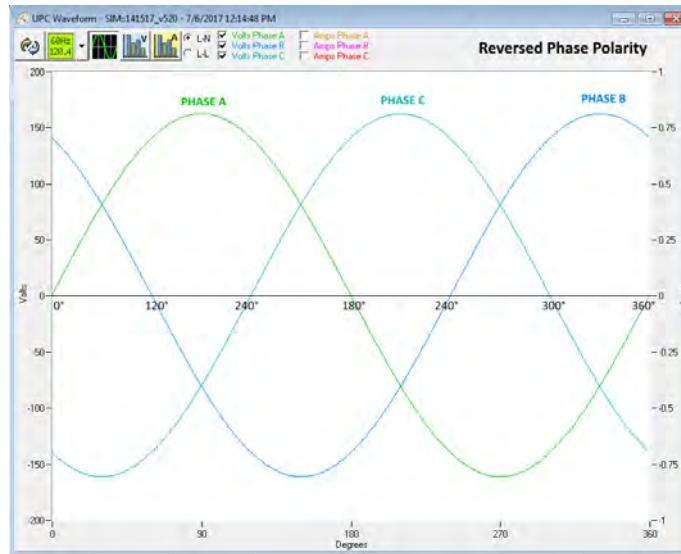

Figure 6-6: Three Phase AC mode Reversed Phase Rotation

6.4.6 Direct Data Entry - Presets

Values for Frequency, Voltage, Current, Phase and Power can be entered directly using the numeric keypad. Position the flashing cursor on the field for which you want to enter a new setting value. Once a field is selected, press the first key of the value you want.

As soon as you enter the first digit, the soft keys will display commonly used values for the parameter you are changing. For example, if you are on the Frequency fields, presets for 50 Hz, 60 Hz, 400 Hz and 800 Hz will appear.

If you are on the Voltage AC field, presets for 115 V, 230 V and 300 V will appear. A Low Voltage Range selection will be offered as well allowing you to lock in the virtual low range, which limits AC voltage entry to no more than 225 Vac. This is illustrated on the image below.

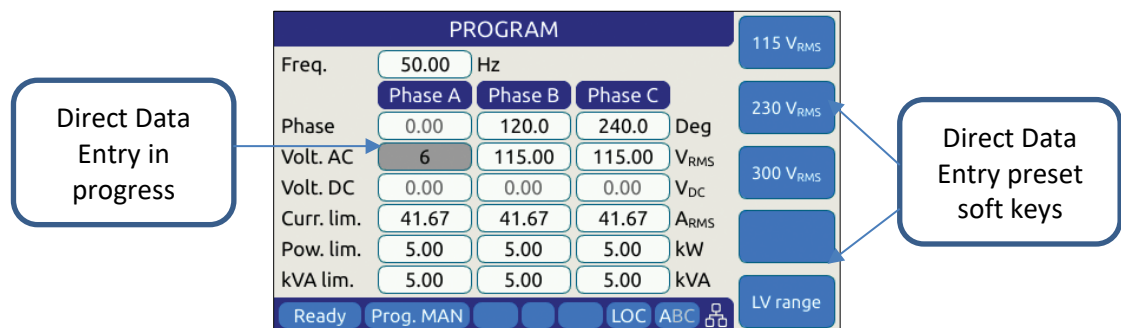

6.4.7 Customizing Output Programming Preset Soft Key Values

The power source allows the user to set up his own preferred or often used output programming values in place of the factory default selections. This can be done from the SYST menu by selecting the UNIT CONFIGURATION 2 OF 2 screen and pressing the “User Presets” soft key.

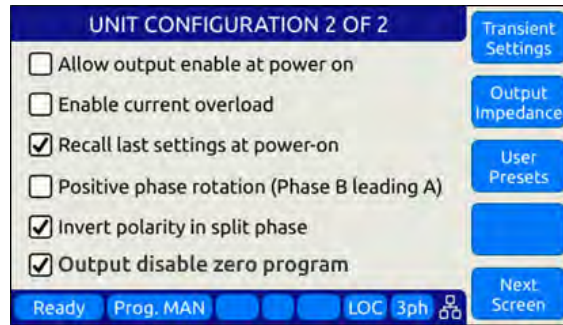

For details on change any available pre-set soft key value, refer to Section 6.7.8, “USER PRESETS Screen” on page 186.

6.4.8 Changing Shuttle Programming Resolution

Once entering EDIT mode on any programmable field – by double clicking the shuttle knob – the parameter value can be slewed by turning the knob. The setting resolution can be changed as needed. If a large value change is needed, a lower resolution will result in a faster change, e.g. changing voltage 10V per click or 1V per click. For a very small change, a 0.1V or 0.01V change per click may be more appropriate.

The selected resolution is reflected by the blinking character when in edit slew mode. To change the position and thus resolution, use the keypad numeric keys. The lowest number keys will select the smallest increment/decrement setting. The higher number keys will select a larger increment/decrement setting.

The table bellows maps the keypad keys to the resolution setting.







Key Pad Key #	Position	Resolution
1 or 2		0.01
3		0.1
4		1
5		10
6, 7, 8 or 9		100
7, 8, 9		1000

Table 6-7: Changing Programming Resolution

6.4.9 Phase Mode Selection

Setting parameters when the AC power source is in single-phase mode (FORM1) is straightforward as there is only one phase to program. Thus, all fields displayed in the PROGRAM screen apply to phase A.

In three-phase mode, there are two ways to program most parameters other than the Frequency:

- Coupled
- Uncoupled

Coupled mode means all phases are set and changed to the same value. Thus, Voltage AC when set or changed applies to all three output phases. This method ensures output phase voltages are always balanced and is convenient for driving normal three phase loads. Coupled mode is indicated by the “ABC” status indicator on the right hand side of the status bar as highlighted below.

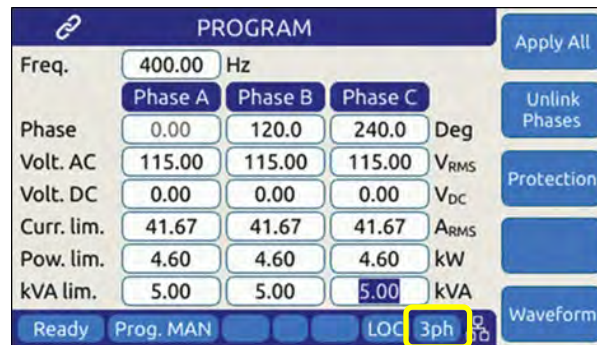

Figure 6-7: Phase Mode Data Entry Status Field

Uncoupled means each phase can be set individually. To do so, the phase to be set or changed must be selected first using the **PHASE** key located on the right hand side of the front panel keyboard. The selected phase (A, B or C) is displayed in the status bar as either “A”, “B” or “C” when in SINGLE phase mode or “3ph” will be displayed when in THREE phase mode.



6.4.10 PROGRAM Soft Keys

The following five soft keys are available on the main PROGRAM screen.

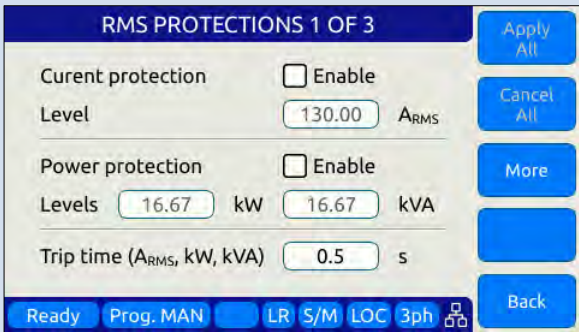
SOFT KEY	Description
Change Style (SK1)	<p>Changes all soft keys to up to five preset values that may be used to change the selected parameter to any of the preset values shown on the soft key labels. This provides a quick way to set commonly used values. It is also possible to reprogram these presets to user specific values. Refer to Section 6.4.5, “Customizing Output Programming Preset Soft Key Values” on page 128 for details.</p> <p>The following presets are offered for the parameters listed:</p> <p>Frequency 50Hz, 60Hz, 400Hz, 800Hz, 1000Hz</p> <p>Voltage AC 115V, 230V, 300V</p> <p>Voltage DC MAX, 200V, 0V, -200V, MIN</p> <p>Current limit MAX, 15A, 4A, PEAK CURRENT</p> <p>Power limit MAX, 4kW, 2kW, 1kW</p> <p>kVA limit MAX, 4kVA, 2kVA, 1kVA</p>
Link Phases Unlink Phases (SK2)	<p>This soft key has the same function as the Phase key on the front panel key pad. It toggles phase coupling in 2 or 3 phase modes between LINK or UNLINKED. When linked, changing one phase parameter changes the other one or two phase set values as well.</p> <p>Note: Does NOT apply to Phase programming for Phase B and C.</p>
Protection (SK3)	<p>Displays the RMS, PEAK POWER AND VOLTAGE PROTECTIONS screens shown below. First screen controls RMS and Power Protection modes.</p> 

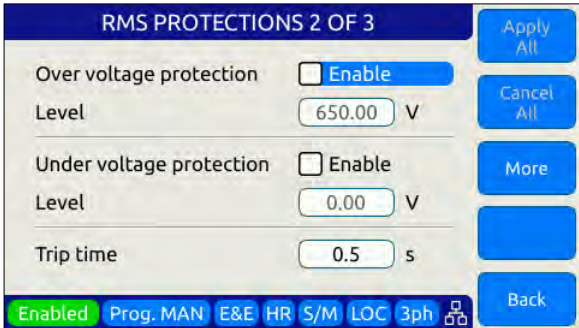
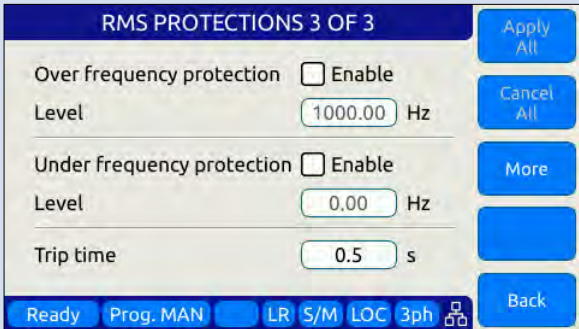
SOFT KEY	Description				
Protection (SK3)	<p>Second screen controls Over and Under Voltage Protection modes.</p> 				
Protection (SK3)	<p>Third screen controls Over and Under Frequency Protection modes.</p>  <p>There are two check box options and one data field on these screens that can be set as needed:</p> <table border="0"> <tr> <td data-bbox="581 1144 657 1171">Enable</td> <td data-bbox="982 1144 1412 1239">Activates the associated function at the value set in the main program screen</td> </tr> <tr> <td data-bbox="581 1255 690 1283">Trip time:</td> <td data-bbox="982 1255 1388 1350">Determines how long the power source will allow the setting to be exceeded before tripping off.</td> </tr> </table>	Enable	Activates the associated function at the value set in the main program screen	Trip time:	Determines how long the power source will allow the setting to be exceeded before tripping off.
Enable	Activates the associated function at the value set in the main program screen				
Trip time:	Determines how long the power source will allow the setting to be exceeded before tripping off.				

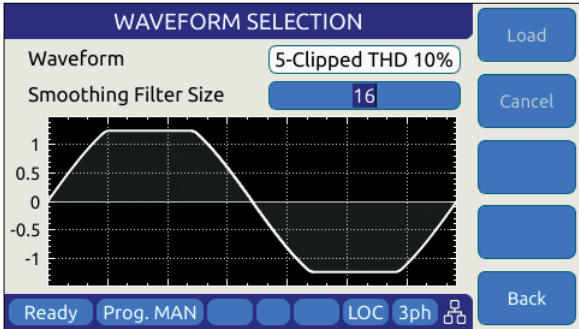
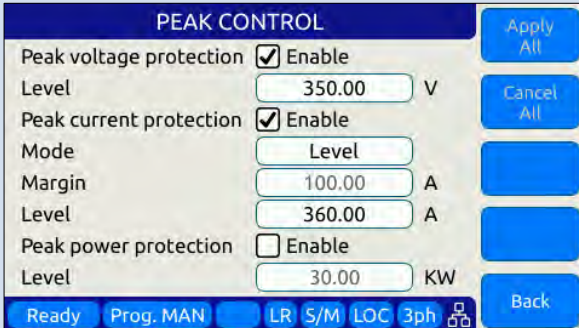
SOFT KEY	Description
<p>Waveform (SK3)</p>	<p>Displays the Waveform selection screen. This function allows the active waveform shape to be changed. Available waveform selections are:</p> <p>Sinewave, Clipped Sinewave 1% THD, Clipped Sinewave 2% THD, Clipped Sinewave 5% THD, Clipped Sinewave 10% THD, Square and Triangle.</p>  <p>Select waveform using the shuttle. Each waveform can be previewed. With the desired waveform displayed, press the “Apply” soft key to confirm. This will take you back to the PROGRAM screen.</p>
<p>Peak Control (SK4)</p>	<p>The peak control screen allow peak current, voltage and/or peak power protection modes to be set and enabled.</p> 

SOFT KEY	Description
<p>Harmonic (SK4)</p>	<p>The Harmonic programming screen allows the user to program harmonic order components for Voltage (Voltage Source Mode) or Current (Current Source Mode). Amplitudes can be enter in percent of Fundamental (Percent) or in absolute values (Voltage/Current). There are five control loops available for this function. Each loop regulates the output for the harmonics number set by the user for each of the five loops.</p> 
<p>Interharmonic (SK4)</p>	<p>The Interharmonic programming screen allows a single interharmonic frequency and amplitude to be super imposed on the output. This applies ot eitehr Voltage Source Mode or Current Source mode as well as Active Load mode.</p> 
<p>More All (SK5)</p>	<p>The “Apply all” soft key is used to confirm all presets made to program parameters in the PROGRAM screen. When pressed, all newly set values are applied to the output and the parameter background colors revert back to white.</p>

Table 6-8: PROGRAM screen soft keys

6.4.11 Available Waveforms

The AZX Series® is supplied with 10 pre-loaded waveforms but can hold a total of 200. The default content of the first 10 registers are shown in the table below. Also shown are the waveform number names and the waveform description each waveform.

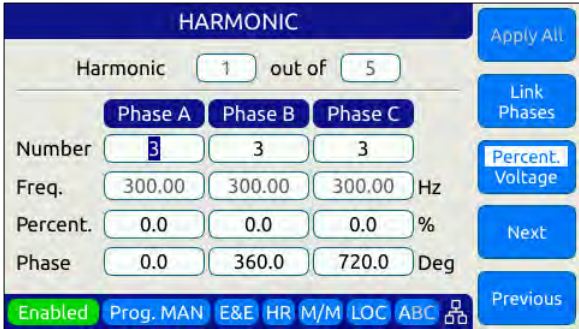
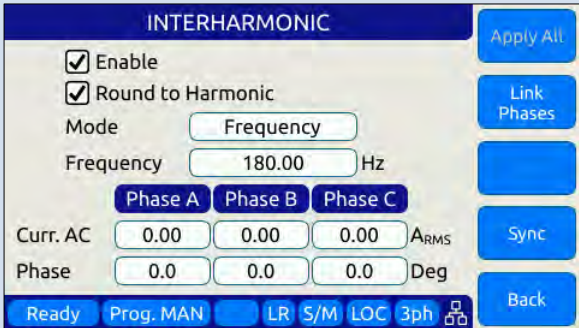
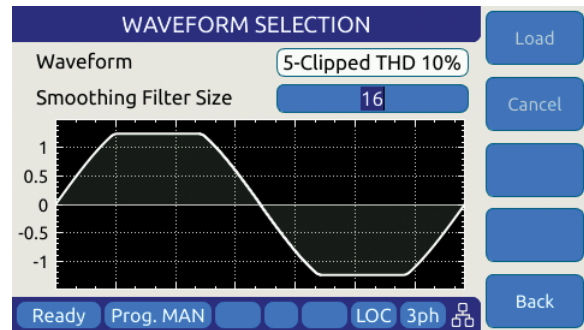

For waveforms with high harmonic content – e.g. sharp transition or fast edges – the smoothing filter feature can be used to smooth out these high frequency events to reduce over/undershoot as needed. The value entered indicates the number of waveform data points that will be averaged to obtain a smoother wave shape. Preview of the resulting smoothed waveform is shown on the LCD screen.

Waveforms can be used for Voltage in AC Source Mode or for Current in AC Load Mode (Option –L required).

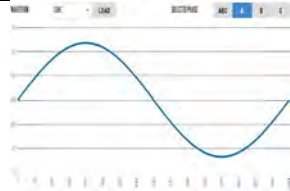
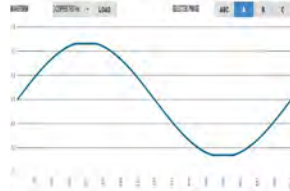
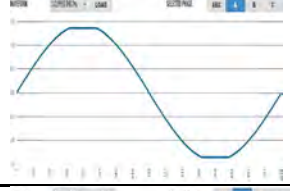
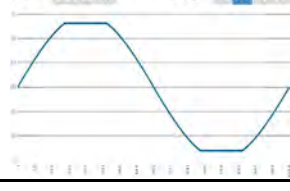
Name	Description	Image	Notes
1	SINE		Standard sine wave. No harmonic content ¹ . This is also the default selected waveform at power on unless a power-on setup is recalled. Waveform 1 is fixed and CANNOT be changed! Note 1: See SOURCE:WAVEFORM:SINEwave command
2	CLIPPED THD 1%		Clipped sine with 1% total harmonic voltage distortion due to flat topping of sinewave peaks.
3	CLIPPED THD 2%		Clipped sine with 2% total harmonic voltage distortion due to flat topping of sinewave peaks.
4	CLIPPED THD 5%		Clipped sine with 5% total harmonic voltage distortion due to flat topping of sinewave peaks.



Name	Description	Image	Notes
5	CLIPPED THD 10%		Clipped sine with 10% total harmonic voltage distortion due to flat topping of sinewave peaks.
6	SQUARE LF		Square wave. Consists of fundamental and all odd harmonics. The LF (low frequency) version is recommended for use below 100Hz.
7	SQUARE HF		Square wave. Consists of fundamental and all odd harmonics. The HF (high frequency) version is recommended for use above 100Hz.
8	SAWTOOTH LF		Saw tooth. Consist of fundamental and both odd and even harmonics. Note: Not recommended for conventional power applications. LF use < 100Hz.
9	SAWTOOTH HF		Saw tooth. Consist of fundamental and both odd and even harmonics. Note: Non-linear! Not recommended for conventional power applications. HF use > 100Hz.
10	TRIANGLE		Triangle. Similar to saw tooth but at same fundamental as a sine wave. Contains fundamental and odd harmonics with amplitudes that roll off as the inverse square of the harmonic number. (1/3, 1/9, 1/25 etc.).
11 ~ 200	User Defined		Waveforms 17 through 200 can be added as needed.

Table 6-9: Available Included AZX Series® Waveforms

6.4.12 Waveform Smoothing Filter

User defined or arbitrary waveforms can contain sudden transients, which equates to high order harmonics. Such types of waveforms can result in over or undershoot when applied at higher frequencies (i.e. 400Hz to 800Hz). An extreme example of this is a pure square wave, which would require infinite output bandwidth to accurately reproduce.

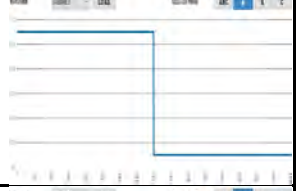
To mitigate this effect, the AZX Series® offers a smoothing filter feature that may be used to smooth these transient. This filter using a moving average method over 1 to 101 samples to reduce the slew rates of these abrupt transitions. A value of 1 represents Disabled (default setting) so no smoothing takes place.

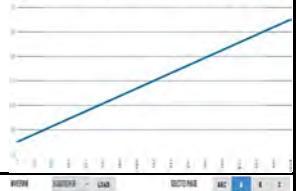
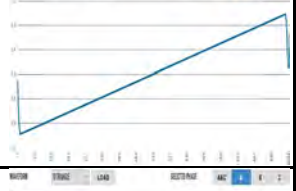
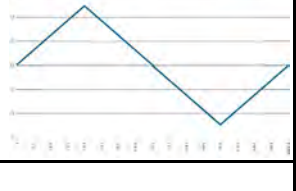
The two samples below show the same square waveform with no smoothing (disabled) and smoothing over 100 waveform data points (max.).

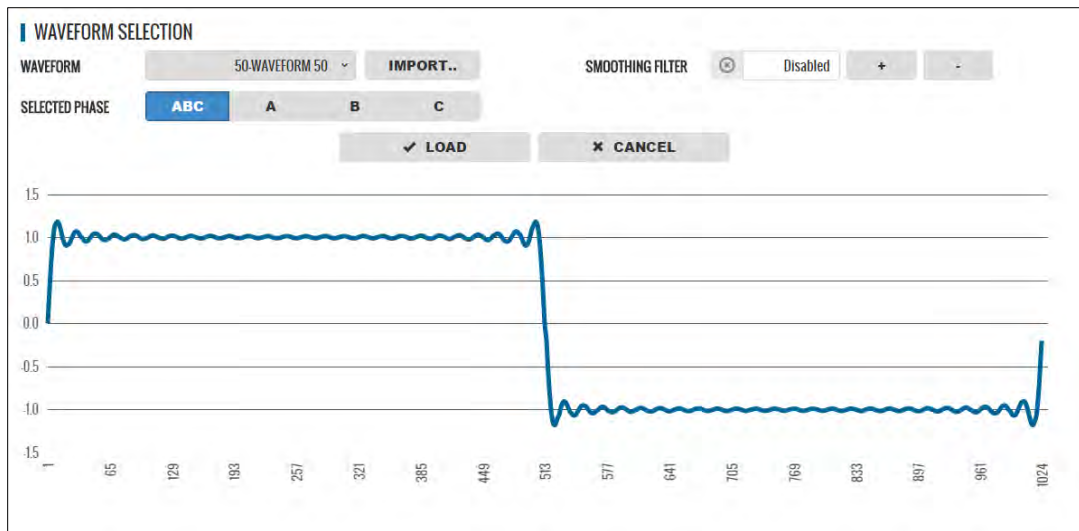

Figure 6-8: Waveform with no Smoothing Filter Applied



Figure 6-9: Same Waveform with maximum smoothing Filter Applied

6.4.13 AUTO RMS Function – Steady State – AC Source Mode

The AUTO RMS mode, if enabled, causes the AC voltage output value to be calculated as a true RMS voltage of the waveform selected. This means the output RMS voltage will remain at the programmed level regardless of a change in waveform shape. This may or may not be what the user intends. For example, adding a transient spike on a sine wave as part of a user defined waveform will cause the overall RMS value to increase so the sinewave portion of this user defined waveform will be attenuated somewhat when used.

When AUTO RMS is disabled, RMS calculation of substituted waveforms does not occur so the output RMS voltage may change from the set value if the waveform selected for output is not a sine wave. This mode is preferred if switching to a user waveform that has a different mathematical RMS value from a sine wave should NOT result in the output voltage amplitude being adjusted to maintain the same RMS level as with a sine wave. As in the previous example, adding a spike or a dip in part of the sinewave will not affect the output amplitude of the sinewave portion.

Note: The setting of the AUTO RMS mode is important when CSC mode is used as CSC mode uses the measured output RMS voltage to adjust the output to maintain voltage regulation.

This mode can be set by sending the `[SOURCE:]WAVEFORM:AUTORMS` command over one of the Digital control interfaces.

The following examples illustrate the different behaviors between AUTO RMS mode ON and OFF.

6.4.13.1 AUTO RMS ON Mode:

In the example below a, 100Vrms sine wave is swapped for a half wave rectified ac waveform. The RMS value of this non-sinusoidal waveform is 1.414x that of a sine wave so the peak value is increased to maintain a 100Vrms output voltage with this wave shape. Not that there is a considerable amount of DC offset present as well due to this non-symmetrical waveform.

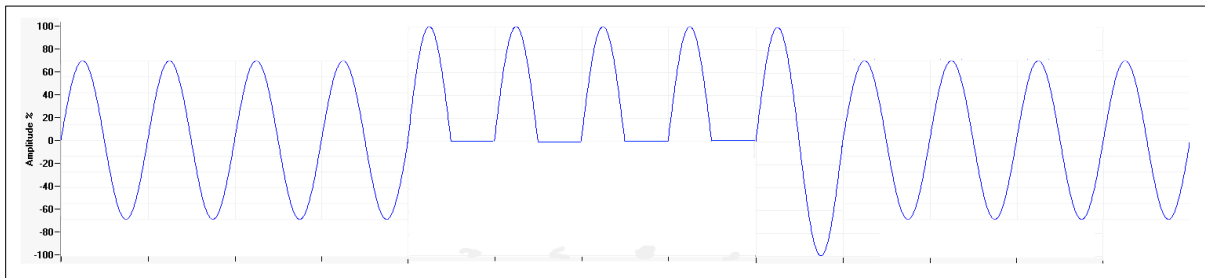

6.4.13.2 AUTO RMS OFF Mode:

Same waveform example but this time with AUTO RMS mode OFF results in no change to output peak voltage but the actual RMS voltage during these four cycles is only 70.7Vrms instead of the 100Vrms programmed setting.

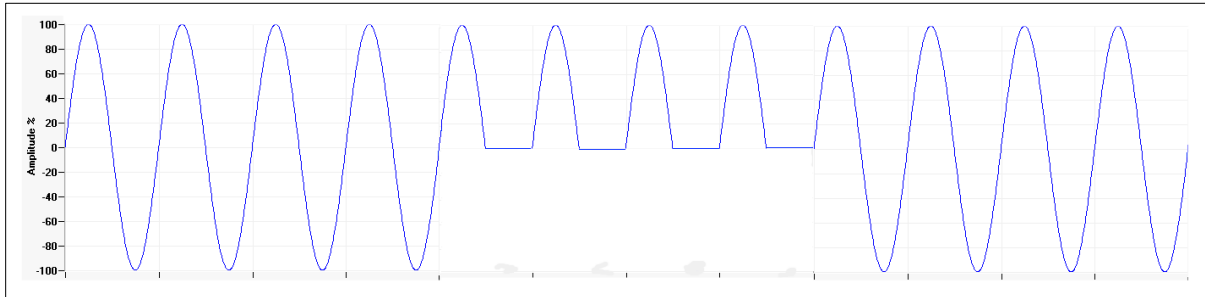

Note: In UPC Compatibility mode, this mode is always enabled.

6.4.14 PROGRAM Harmonics

The Harmonics programming screen is accessed from the PROGRAM screen using the “Harmonics” soft key (SK#4). Use the More soft key (SK#5) if the Harmonics soft key is not visible.

Harmonics can be generated using a harmonic waveform using the Arbitrary waveform capabilities of the power source as well but with that approach, only the RMS Voltage or Current Level is regulated, not the individual harmonic Voltage or Current Components.

The Harmonics programming function allows up to five individual harmonic components to be defined. There is an independent load regulation loop for each of these five harmonics that results in more precise harmonic amplitude levels.

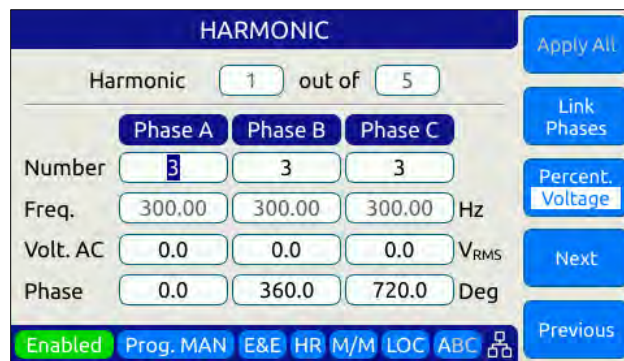

The five programmable harmonics can be anywhere from 2 to 50. For each harmonic, the frequency is automatically calculated and displayed as the multiple of the set fundamental frequency. Voltage or Current amplitude in Vrms / Arms or % of Fundamental Vrms / Arms can be set for each harmonic set. Same is true for phase angles.

6.4.15 PROGRAM Interharmonics (Option C)



The interharmonics programming screen can be selected using the Inter-harmonic Soft key (SK#4). Use the More soft key (SK#5) if the Harmonics soft key is not visible. This screen allows entry of the interharmonics frequency (Hz), the amplitude (Vrms or Arms in absolute or percent of fundamental) and the relative phase angle with respect to the phase A output AC voltage or current.

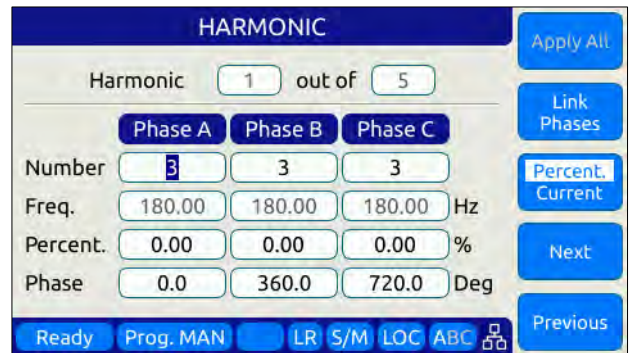
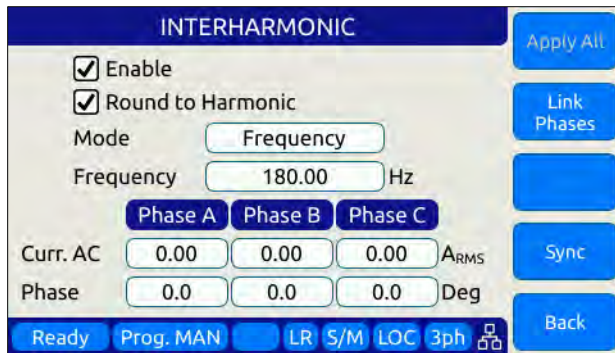

To output the Interharmonics programmed, set the Enable setting.

Note: For IEC 61000-4-13 Interharmonics compliance testing, refer to the Ects_413Gui Windows Software available from Pacific Power Source.

6.4.16 DEVIATION Setpoint Programming

Deviation setpoints is a special mode of setting output parameters that are interdependent on each other. This mode of programming is rather unique. This allows for a deviation of a setting based on measurements made by the power source. These measurement values can be used to change settings for one or more programmable settings such as voltage, frequency and phase shift.

There are 4 setpoints that allow this, which will be available depending on the mode in which the unit is operating.

- Frequency
- Phase
- Voltage AC
- Voltage DC

To access the Deviation settings from the front panel, press the PROG menu key till you see the second of three PROGRAM screens that has the “Deviation” softkey #4 as shown below. Press “Deviation” to access the Deviation setting screen shown on the right.



Each setpoint can be simultaneously affected by 3 different variables. The formula to calculate the deviation is:

$$\begin{aligned} \text{VALUE} = & \text{SETPOINT} + (\text{VARIABLE}_1 - \text{CENTER}_1) * \text{FACTOR}_1 \\ & + (\text{VARIABLE}_2 - \text{CENTER}_2) * \text{FACTOR}_2 \\ & + (\text{VARIABLE}_3 - \text{CENTER}_3) * \text{FACTOR}_3 \end{aligned}$$

Deviations Settings

For each parameter setpoint, you can set one or more of the following settings:

Setpoint: Some will be disabled depending on the operating mode and the unit setpoint mode selected. For example, in DC mode, the AC frequency, phase, and voltage are disabled.

Variable # (number): This variable selector allows configuring up to 3 deviations.

Factor: This command allows changing the multiplicity factor to calculate the deviation. See formula 1.

Variable: This parameter configures which measurement value will affect the setpoint. If “None” option is selected, the setpoint is disabled. The options are:

- None
- Voltage RMS
- Voltage AC RMS
- Voltage DC
- Voltage DC Absolute
- Voltage LL RMS
- Voltage LL AC RMS
- Voltage LL DC
- Voltage LL DC Absolute
- Current RMS
- Current AC RMS
- Current DC
- Current DC Absolute
- Active Power
- Apparent Power
- Frequency

Variable center: This parameter helps to calculate the deviation, establishing a measurement value based on the chosen variable. See formula 1.

Slew rate: Allows configuring the speed with which the deviation will affect the setpoint.

Range: Parameter to set the maximum deviation allowed.

Example:

This example shows the variation of the frequency based on the load’s RMS current. Initially the frequency is 50 Hz at 1.0 ARMS. By applying the deviation setting, the measurement of the frequency is 25 Hz when the RMS current is 80.0 ARMS.

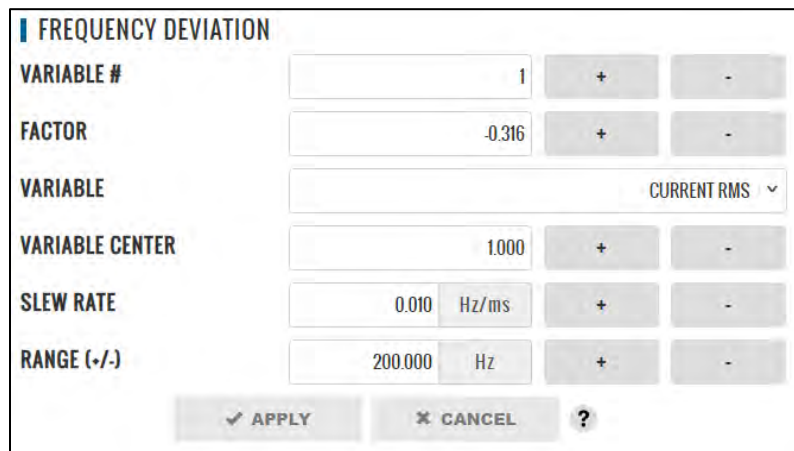

FREQUENCY DEVIATION			
VARIABLE #	1	+	-
FACTOR	-0.316	+	-
VARIABLE	CURRENT RMS ▾		
VARIABLE CENTER	1.000	+	-
SLEW RATE	0.010	Hz/ms	+
RANGE (-/+)	200.000	Hz	+
		✓ APPLY	✗ CANCEL
		?	

$$\begin{aligned}
 \text{VALUE} &= 25.0 \text{ [Hz]} \\
 \text{SETPOINT} &= 50.0 \text{ [Hz]} \\
 \text{VARIABLE}_1 &= 80.0 \text{ [A}_{\text{RMS}}] \\
 \text{CENTER}_1 &= 1.0 \\
 50.0 &= 25.0 + (80.0 - 1.0) * \text{FACTOR}_1 \\
 \text{FACTOR}_1 &= \frac{(25.0 - 50.0)}{(80.0 - 1.0)} \\
 \text{FACTOR}_1 &= -0.316
 \end{aligned}$$

Internal Scope capture of output voltage with 1 Arms load current:

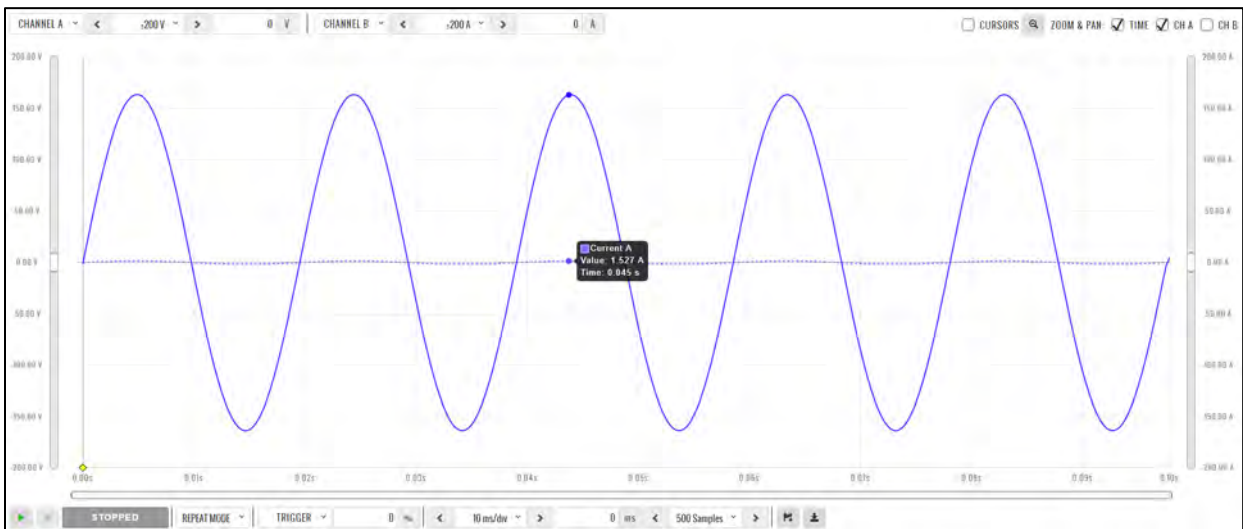

Internal Scope capture of output voltage with 80 Arms load current:

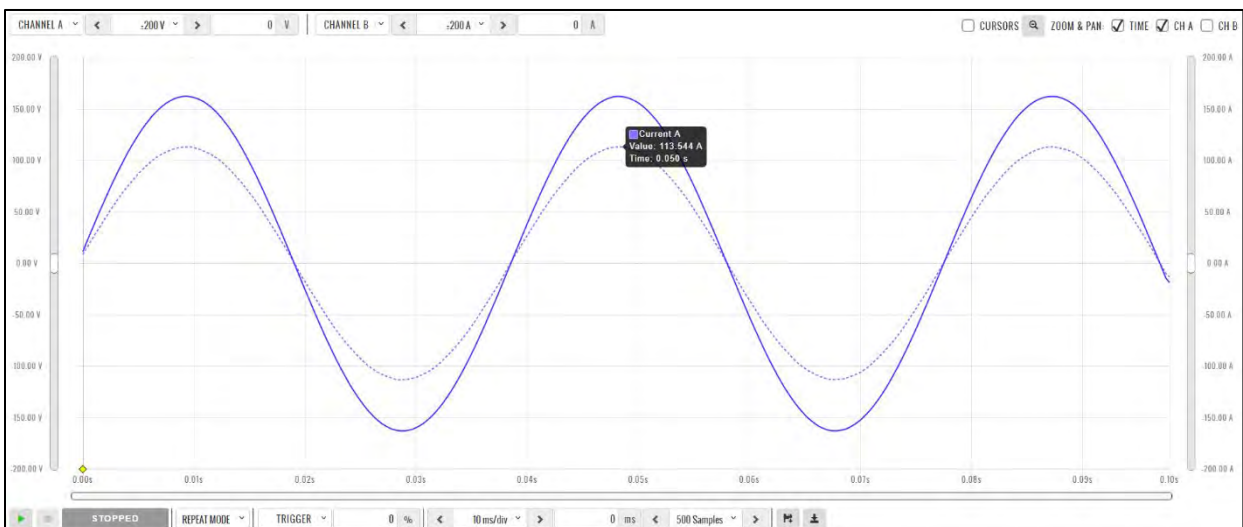

6.5 MEAS – MEASUREMENTS Screens

The MEAS menu key displays the first of four measurement screens. Measurement screens are used to display measurement values taken at the output of the AC power source.

The measurements screen layouts differ between single phase and multiphase mode. If the power source is configured for single-phase mode operation, only the single phase measurement screens are available. When in three phase mode, the user can change screens between all three phases or one phase at a time using the PHASE key located below the Output ON/OFF key or by pressing the “Individual Phase” soft key (SK5).

Note that power and current can flow in either direction. When the power source is absorbing energy from the EUT, the current and power will show a minus sign. This is also the case when the AZX is in Load mode (Option L).

6.5.1 Measurements Screen

The different measurement screen layouts are shown below.

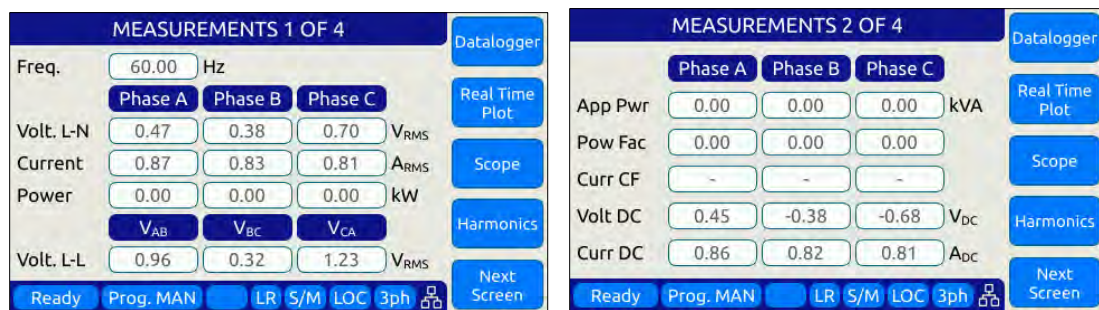

Figure 6-10: Measurement Screens 1 through 2

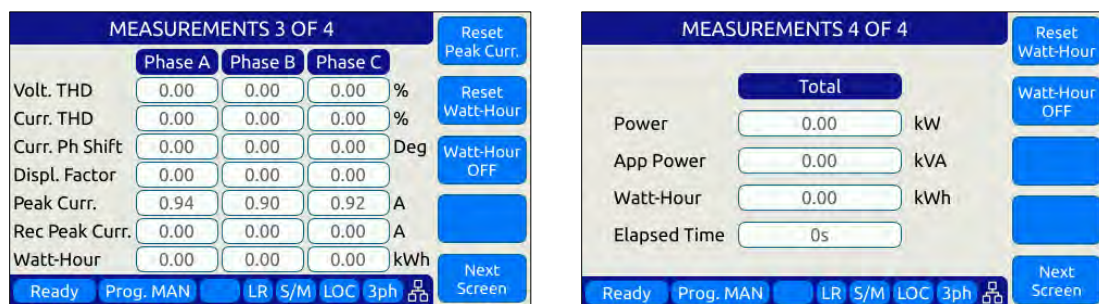
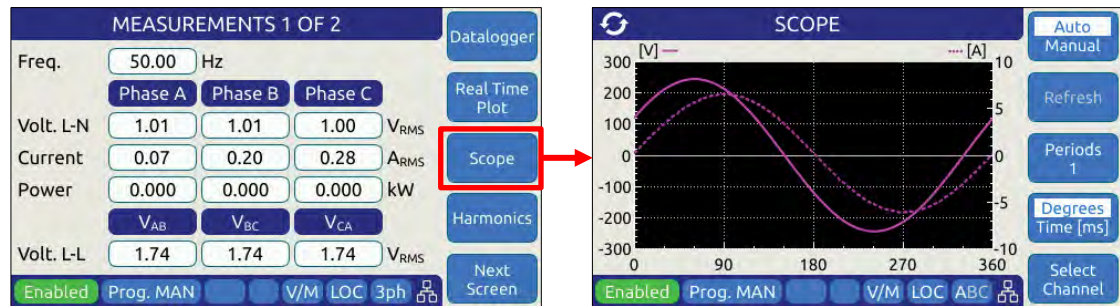

Figure 6-11: Measurement Screens 3 through 4

6.5.2 Scope Measurements

Scope measurements allow all voltage and current phases to be captured and displayed in the time domain. From one to four cycles of the fundamental frequency can be displayed. Display modes include all voltages, all currents, both voltage and current or individual phase selected voltage and current. Use the “Scope” soft key from the Measurement screen to select Scope measurements.



Note that voltage scope captures can be set for Line to Neutral voltage or Line to Line Voltage when in three phase mode. To select the desired mode, use the Select Channel soft key.

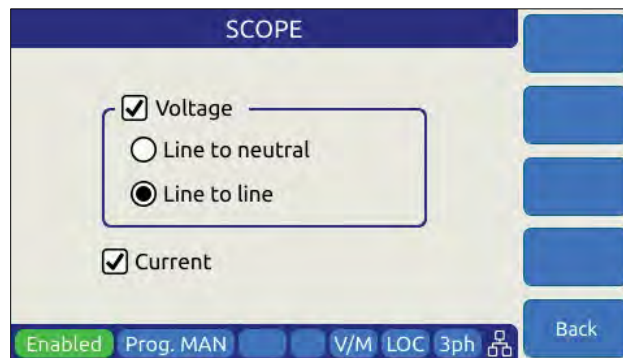

6.5.3 Harmonic Measurements

Harmonic measurements for all phase voltages and currents can be measured and displayed in either chart or table format. Use the “Harmonics” soft key from the Measurement screen to select Harmonics measurements.

The interface consists of three main screens:

- MEASUREMENTS 1 OF 2:** Shows real-time data for three phases (A, B, C) for Voltage (V_{RMS}), Current (A_{RMS}), and Power (kW). A red box highlights the "Harmonics" button.
- HARMONIC PLOT (%-N):** A bar chart showing harmonic magnitudes for orders 2 through 16. The y-axis ranges from 0 to 1.5. Buttons include Auto Manual, Refresh, Zoom Scroll, Voltage Current, and Table.
- HARMONIC PLOT (%-N) (Zoomed):** A zoomed-in view of the harmonic plot with a y-axis from 0 to 360.
- HARMONICS ANALYSIS:** A table summarizing harmonic data.

#	Mag. A [%]	Mag. B [%]	Mag. C [%]
THD	848.20	304.79	856.31
EHD	662.32	219.79	608.35
OHD	529.88	211.16	602.64
1	100.00	100.00	100.00
2	37.14	31.28	24.31
3	95.59	54.31	71.46
4	80.16	9.87	79.46
5	62.99	34.10	82.90

6.5.4 Measurement Screen Soft Keys

The following five soft keys are available on the two three-phase measurement screens.

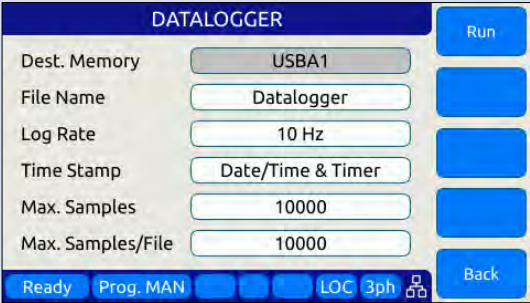
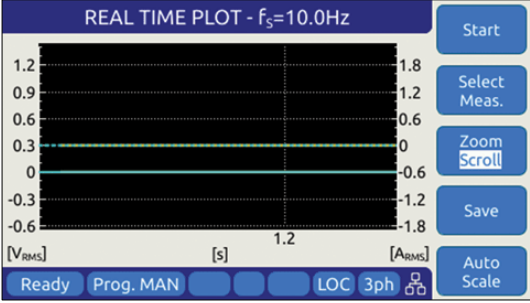
SOFT KEY	Description										
Datalogger (SK1)	<p>The Datalogger soft key allows setting the measurement data logging memory type to be selected, sample rate and no. of samples to be logged to memory. To use a usb memory stick (32GB max), insert it in one of the two USB ports on the front panel and select either USBA1 or USBA2. Only memory devices found will be selectable in addition to the default internal RAM (volatile) memory.</p> 										
Real Time Plot (SK2)	<p>Display strip chart of voltage, current or both against time. This provides a trend plot of any available measured parameter.</p>  <p>The following soft keys are available to control the time plot:</p> <table border="0"> <tr> <td>Start</td> <td>Starts time plot.</td> </tr> <tr> <td>Select Meas.</td> <td>Select parameters to display</td> </tr> <tr> <td>Zoom or Scroll</td> <td>Zoom both X and Y axis</td> </tr> <tr> <td>Save</td> <td>Saves plot data to memory device</td> </tr> <tr> <td>Auto Scale</td> <td>Auto-scale the Y axis (Amplitude)</td> </tr> </table>	Start	Starts time plot.	Select Meas.	Select parameters to display	Zoom or Scroll	Zoom both X and Y axis	Save	Saves plot data to memory device	Auto Scale	Auto-scale the Y axis (Amplitude)
Start	Starts time plot.										
Select Meas.	Select parameters to display										
Zoom or Scroll	Zoom both X and Y axis										
Save	Saves plot data to memory device										
Auto Scale	Auto-scale the Y axis (Amplitude)										

SOFT KEY	Description
<p>Scope (SK3)</p>	<p>Toggles to the Scope Measurement displac screen.</p> 
<p>Harmonicis (SK4)</p>	<p>Toggles to the Scope Measurement displac screen.</p> 
<p>Next Screen (SK5)</p>	<p>This soft key allows toggling between the two available measurement screens. The same can be accomplished by pressing the MEAS button on the left hand side of the LCD display.</p>

Table 6-10: Measurement Screen Soft Keys

6.5.5 Measurement Data Logging

Logging measurement data is easy to do using the Datalogging function. Files are saved in a comma separated value text file which is easily imported into MS Excel or other programs for analyzer and / or display purposes.

Destination memory defaults to internal RAM allowing log files to be downloaded to browsers or local drives using the web server SYSTEM -> MEMORY BROWSER menu entry.

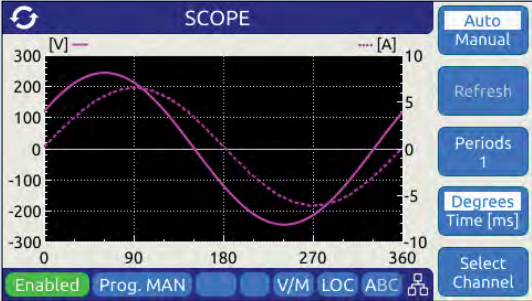
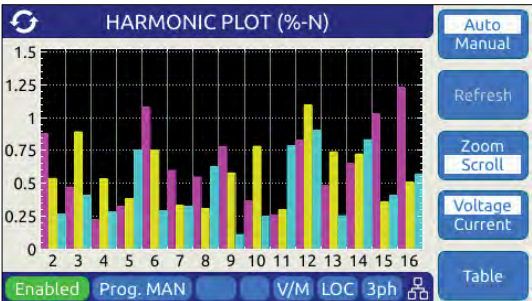
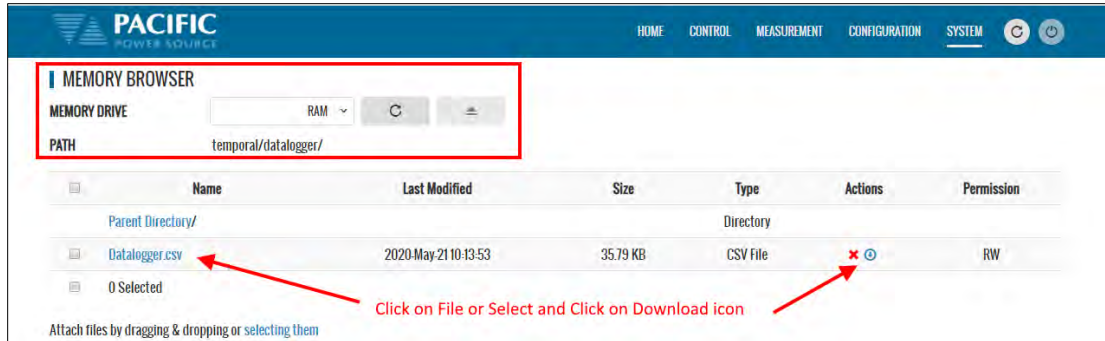

A small data logging file sample is shown here for reference.

```
Date & Time,Timer,Frequency,Voltage VLL ACDC A-B,B-C,C-A,Voltage VLL AC A-B,B-C,C-A,Voltage VLL DC A-B,B-C,C-A,Voltage LN ACDC A,B,C,Voltage LN AC A,B,C,Voltage LN DC A,B,C,Current RMS A,B,C,Current DC A,B,C,Power A,B,C,App. Power A,B,C,Power Factor A,B,C,Peak Current A,B,C,Crest Factor A,B,C,
21/4/2020 10:13:17.647,0.00,60,207.846,207.845,207.846,207.846,207.845,207.846,0.0015717,0.000892723,0.000678978,120,120,120,120,120,5.74293e-05,0.00162913,0.000736408,0.0961562,0.0658469,0.0389105,0.00917411,0.00100751,-0.00516246,0.00012973,0.000672549,0.00066903,0.0115388,0.00790161,0.00466924,0,0,0,0.249016,0.199247,0.126655,0,0,0,
21/4/2020 10:13:17.748,0.101,60,207.845,207.846,207.847,207.845,207.846,207.847,0.000484911,0.000716525,0.000231614,120,119.999,120.001,120,119.999,120.001,0.000291418,-0.000193493,0.000523032,0.0963041,0.0660525,0.0392375,0.00873799,0.000840356,-0.0050699,0.000142419,0.000692023,0.000528912,0.0115565,0.0079262,0.00470855,0,0,0,0.245361,0.199247,0.126651,0,0,0,
21/4/2020 10:13:17.847,0.200,60,207.845,207.843,207.844,207.845,207.843,207.844,0.00195489,0.000834307,0.0027892,120,119.999,119.998,120,119.999,119.998,0.00201776,6.2867e-05,-0.00077144,0.0957361,0.0658142,0.0392642,0.00805068,0.000924351,-0.00582215,0.000124226,0.000720164,0.000534704,0.0114883,0.00789763,0.00471161,0,0,0,0.249,0.195608,0.128863,0,0,0,
21/4/2020 10:13:17.947,0.300,60,207.844,207.847,207.846,207.844,207.847,207.846,7.05616e-05,0.000486062,0.000556624,119.998,119.999,120.002,119.998,119.999,120.002,0.000496289,0.000425727,-6.03351e-05,0.0967671,0.0652786,0.0393575,0.00906719,0.000913487,-0.0051749,0.000184154,0.00060259,0.00057676,0.0116118,0.00783339,0.00472296,0,0,0,0.252638,0.192,0.126645,0,0,0,
```

Using Excel to select several measurement columns allows for easy plotting of trends. For example VLN for A, B and C (Y-axis) against no of samples (X-axis) as shown below.

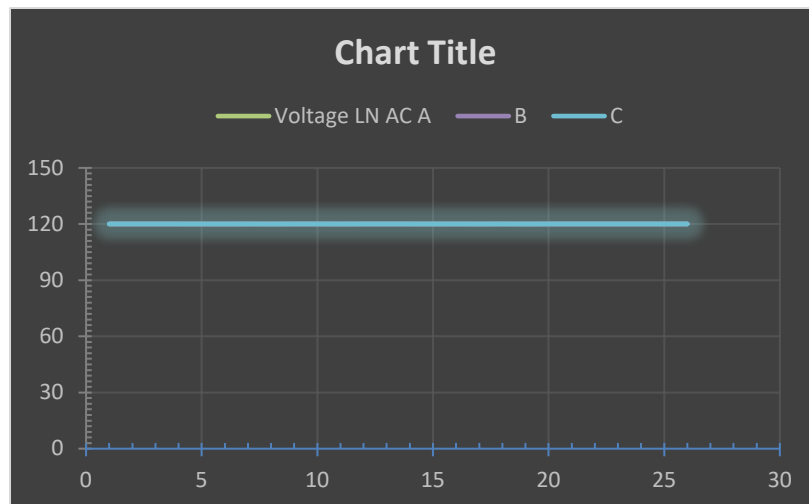

6.5.6 Three Phase Measurement Screen Soft Keys

The following five soft keys are available on the two three-phase measurement screens.

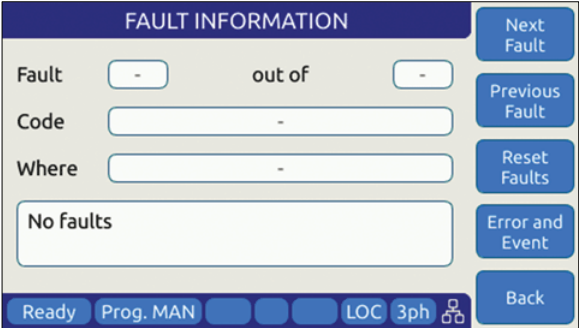
SOFT KEY	Description								
Meas. Page 2 (SK1)	The first soft key allows toggling between the two available measurement screens. The same can be accomplished by pressing the MEAS button on the left hand side of the LCD display.								
Fault Status (SK2)	<p>Pressing this soft key displays the Fault Status screen. The fault status shows a history list of possible error or fault messages that have been recorded by the power source.</p>  <p>The following soft keys are available to review or clear fault messages:</p> <table border="0"> <tr> <td>Next Fault</td> <td>Scrolls to the next available fault message if any.</td> </tr> <tr> <td>Previous Fault</td> <td>Scrolls to the previous fault message if any.</td> </tr> <tr> <td>Reset Faults</td> <td>Clear Fault Buffer</td> </tr> <tr> <td>Clean and Refresh</td> <td>Clears displayed faults and updates</td> </tr> </table>	Next Fault	Scrolls to the next available fault message if any.	Previous Fault	Scrolls to the previous fault message if any.	Reset Faults	Clear Fault Buffer	Clean and Refresh	Clears displayed faults and updates
Next Fault	Scrolls to the next available fault message if any.								
Previous Fault	Scrolls to the previous fault message if any.								
Reset Faults	Clear Fault Buffer								
Clean and Refresh	Clears displayed faults and updates								
(SK 4)-	N/A								

SOFT KEY	Description										
<p>Real Time Plot (SK3)</p>	<p>Display strip chart of voltage, current or both against time. This provides a trend plot of any available measured parameter.</p>  <p>The following soft keys are available to control the time plot:</p> <table border="0"> <tr> <td>Start</td> <td>Starts time plot.</td> </tr> <tr> <td>Select Meas.</td> <td>Select parameters to display</td> </tr> <tr> <td>Zoom Y</td> <td>Zoom both X and Y axis</td> </tr> <tr> <td>Save</td> <td>Saves plot data to memory device</td> </tr> <tr> <td>Clean and Refresh</td> <td>Auto-scaled Y axis</td> </tr> </table>	Start	Starts time plot.	Select Meas.	Select parameters to display	Zoom Y	Zoom both X and Y axis	Save	Saves plot data to memory device	Clean and Refresh	Auto-scaled Y axis
Start	Starts time plot.										
Select Meas.	Select parameters to display										
Zoom Y	Zoom both X and Y axis										
Save	Saves plot data to memory device										
Clean and Refresh	Auto-scaled Y axis										
<p>Individual Phase (SK5)</p>	<p>Displays the individual phase measurement screen for Phase A. To select other screens, use the PHASE key on the front panel or the first three soft keys on the measurement screen.</p>										

Table 6-11: Three Phase Measurement Screen Soft Keys

6.5.7 Individual Phase Measurement Screen Soft Keys

The following five soft keys are available on the individual phase measurement screens.

SOFT KEY	Description										
Phase A (SK1)	Displays individual phase measurement screen for phase A if not already displayed.										
Phase B (SK2)	Displays individual phase measurement screen for phase B if not already displayed.										
Phase C (SK3)	Displays individual phase measurement screen for phase C if not already displayed.										
Real Time Plot (SK4)	<p>Display strip chart of voltage, current or both against time. This provides a trend plot of any available measured parameter.</p>  <p>The following soft keys are available to control the time plot:</p> <table border="0"> <tr> <td>Start</td> <td>Starts time plot.</td> </tr> <tr> <td>Select Meas.</td> <td>Select parameters to display</td> </tr> <tr> <td>Zoom Y</td> <td>Zoom both X and Z axis</td> </tr> <tr> <td>Save</td> <td>Save plot data to memory device</td> </tr> <tr> <td>Clean and Refresh</td> <td>Auto-scaled Y axis</td> </tr> </table>	Start	Starts time plot.	Select Meas.	Select parameters to display	Zoom Y	Zoom both X and Z axis	Save	Save plot data to memory device	Clean and Refresh	Auto-scaled Y axis
Start	Starts time plot.										
Select Meas.	Select parameters to display										
Zoom Y	Zoom both X and Z axis										
Save	Save plot data to memory device										
Clean and Refresh	Auto-scaled Y axis										
Phase ABC (SK5)	Displays the three-phase measurement screen.										

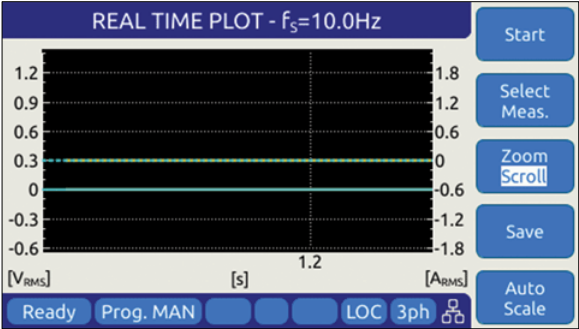
Table 6-12: Individual Phase Measurement Screen Soft Keys

6.6 TRAN- TRANSIENTS Screens

Transient sequences allow precise time-controlled changes to be made to voltage (AC and DC mode) and frequency (AC mode only) under program control. A transient sequence consists of one or more list entries (or segments) that are executed in sequence. Transient List setting is the same for Voltage or Current source Modes except Voltage is set in Voltage Source mode and Current in Current Source mode.

There are three types of Transients modes:

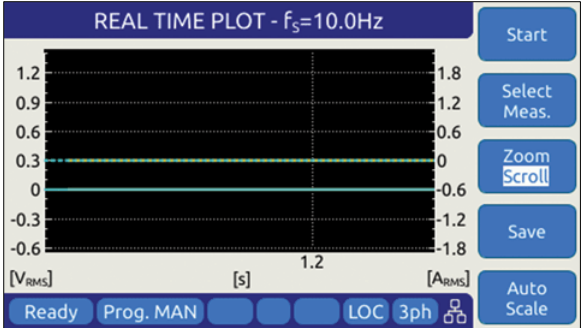
- **LIST Mode**
- **STEP and RAMP Mode**
- **PULSE Mode**

Note that Step and Pulse transients can be accomplished using LIST mode as well but STEP and PULSE data entry is more intuitive.



Transients are created or edited in EDIT mode and can be saved to non-volatile memory as part of an instrument setup. They are executed in Execution mode.

The following sections cover all available transient modes.

6.6.1 LIST Mode

List mode is the most versatile transient data entry mode as it allows any of the other Transients types to be created as well. However, entering a long ramp or step transient consisting of many discrete steps in List mode is time consuming and tedious. It is also easier to make a mistake in LIST mode than using the STEP or RAMP mode. Same is true for PULSE transients which can be created with a short transient list as well.

LIST transients can be created from the front panel, using the LXI web server and a web browser or with Pacific's PPCS Manager Windows software.

An example Transient LIST created from the front panel is shown below.

TRANSIENT VIEW				
#	Freq	Volt AC	Volt DC	Dwell
1	400.00	115.00	0.00	100.0
2	400.00	100.00	0.00	10.0
3	400.00	115.00	0.00	100.0
4	400.00	100.00	0.00	10.0
5	400.00	115.00	0.00	100.0
6	400.00	100.00	0.00	10.0
7	400.00	115.00	0.00	100.0
8	400.00	100.00	0.00	10.0

TRANSIENT VIEW				
#	Freq	Curr AC	Curr DC	Dwell
1	400.00	15.00	0.00	100.0
2	400.00	50.00	0.00	10.0
3	400.00	15.00	0.00	100.0
4	400.00	50.00	0.00	10.0
5	400.00	15.00	0.00	100.0
6	400.00	50.00	0.00	10.0
7	400.00	15.00	0.00	100.0
8	400.00	50.00	0.00	10.0

6.6.2 LIST Parameters

The following parameters are available in each list transient list step.

PARAMETER	Range	Unit	Description
#	1 - 199	-	Displays the row number in the transient table. These numbers are generated automatically.
Ramp	0.2 - 9999	msec.	Ramp time to slew from existing set point to new set point value. Applies to both Frequency and Voltage. If previous set value is the same as new value, the value is not slewed but rather stays at the same value for the duration of the ramp time.
Frequency	15 – 1000	Hz	New frequency value
Voltage AC	0 – 360	V/A rms	New AC voltage or current value
Voltage DC	0 – 510	V/A dc	New DC voltage or current value
Dwell	0.2 - 9999	msec.	Dwell time. At the end of the ramp time, the new set values remain in effect during the dwell period. At the end of the dwell time, the next list entry (if any) will be executed.

Table 6-13: Available LIST Transient Parameters

Voltage LIST Transient Example 1

The table and associated figure below illustrates the operation of a transient. The blue line represents the RMS value of the phase A output voltage.

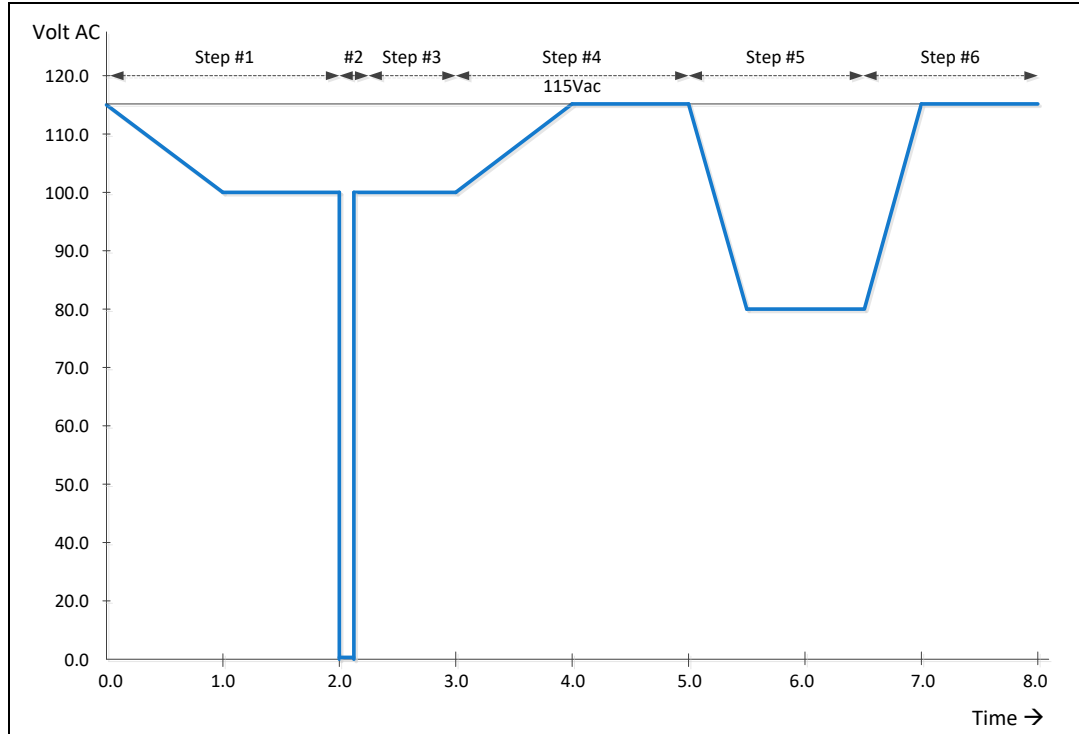

Figure 6-12: Voltage Transient Example 1

To generate this voltage versus time output sequence, the following transient list entries are required. (Ramp and dwell times shown in milliseconds using STEP mode.)

#	Ramp	Freq	Volt	Dwell
1	1000	400	100.00	1000
2	0.2	400	0.00	100
3	0.2	400	100.00	900
4	1000	400	115.00	1000
5	500	400	80.00	1000
6	500	400	115.00	1000

Table 6-14: Voltage Transient List for Example 1

Voltage and Frequency LIST Transient Example 2

This example is based on an actual avionics test requirement from RTCA/DO160 Section 16 test number 16.5.2.1d. This is a single-phase abnormal voltage and frequency limit test for airborne equipment operated from 400Hz AC power.

The requirement from the test standard is shown in the table below:

TEST	VOLTAGE (V rms)	FREQUENCY (Hz)
1	122	430
2	100	430
3	122	370
4	100	370

Table 6-15: RTCA/DO160 Section 16 test number 16.5.2.1d

There are four tests, each runs for at least 5 minutes or 300 seconds. Each test step has a different voltage and frequency deviation from the nominal 115V and 400Hz. This is graphically illustrated by the image below.

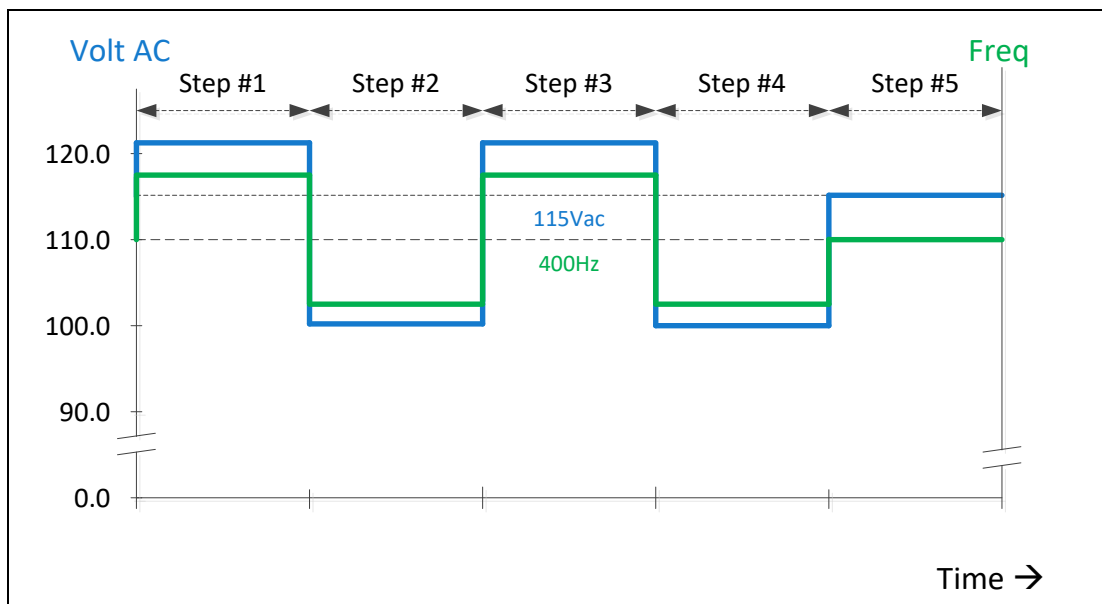

Figure 6-13: RTCA/DO160 Section 16 test number 16.5.2.1d

To generate this DO160 test sequence, the following transient list entries are required. Times shown in milliseconds.

#	Ramp	Freq	Volt	Dwell
1	0.2	430	122.00	300000
2	0.2	370	100.00	300000
3	0.2	430	122.00	300000
4	0.2	370	100.00	300000
5	1000	400	115.00	300000

Table 6-16: Voltage Transient List for Example 1

6.6.3 LIST Transient Edit Mode

To create a new transient program, press the **TRAN** key to select the Transient screen and then select the preferred data entry mode, LIST, STEP/RAMP or PULSE. If no transients have been entered or recalled, the initial screen will be blank.

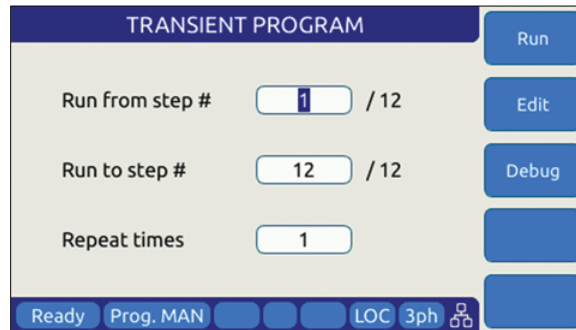

Figure 6-14: Blank TRANSIENT PROGRAM screen

The only available soft key is the “Create” key (SK1). Press the “Create” soft key to enter the Transient Edit mode. This will display the TRANSIENT VIEW screen.

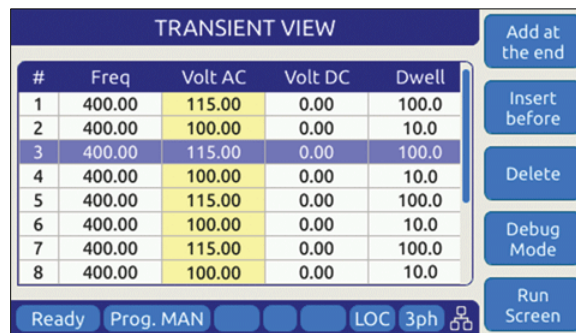

Figure 6-15: TRANSIENT VIEW Edit Mode

In Edit mode, a number of soft keys are available to aid in editing new or existing transient lists. They are defined in the following table.

SOFT KEY	Description
Add at the end (SK1)	Adds a new row entry at the bottom of the transient list table. If there are no table entries yet (new), pressing this key will add the first line of a new transient table.
Insert before (SK2)	Insert a new table row before the current selected row. The selected row and any rows below that are all pushed down one position.
Delete (SK3)	Deletes the current selected row. Any rows below the selected row are pushed up one position. Note: This action cannot be undone.

SOFT KEY	Description
Debug Mode (SK4)	Displays the Debug Execution mode screen. See section 6.6.4
Run Screen (SK5)	Returns to the regular TRANSIENT PROGRAM screen used for transient execution mode. See section 6.6.4.

Table 6-17: Available TRANSIENT EDIT screen soft keys

Once created, a transient sequence can be saved as part of the instrument setup. Refer to Section 6.7.4 for information on saving and recalling setups.

6.6.4 LIST Transient Execution Modes

Transients can be executed as soon as they have been entered. To execute a transient, the output **must be ON**. Sometimes it is best to debug a new transient sequence to make sure it performs the intended test and all values were entered correctly. To do so, the DEBUG mode is provided.

DEBUG MODE

The debug mode can be selected from the TRANSIENT VIEW screen by pressing the “Debug Mode” soft key (SK4). This changes the TRANSIENT VIEW screen from EDIT to DEBUG mode and displays a different set of soft keys to control execution.

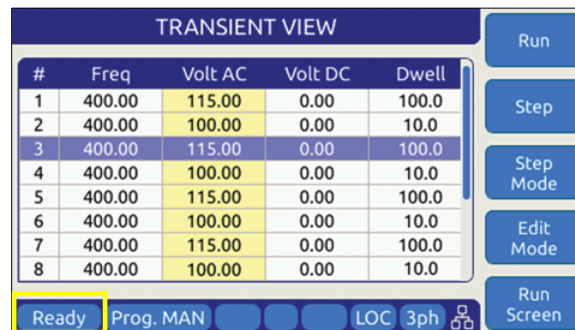

Figure 6-16: TRANSIENT Debug mode screen

The following execution control soft keys are available.

SOFT KEY	Description
Run (SK1)	Starts the transient from the currently selected row number
Step (SK2)	Single steps one row at a time
Step Mode (SK3)	Executes one step at a time
Edit Mode (SK4)	Stops execution and reverts to Edit mode
Run Screen (SK5)	Returns to the regular TRANSIENT PROGRAM screen used for transient execution mode. See section 6.6.4.

Table 6-18: Available TRANSIENT DEBUG screen soft keys

Note: The progress of the transient is indicated by the “Program” status bar at the bottom of the screen.

NORMAL EXECUTION MODE

Transient execution is controlled from the TRANSIENT PROGRAM screen. If no transient data has been entered, no run mode soft key will be visible. In that case, you must use the “Create” soft key to create a new transient sequence table.

The TRANSIENT PROGRAM screen for LIST mode is shown below.

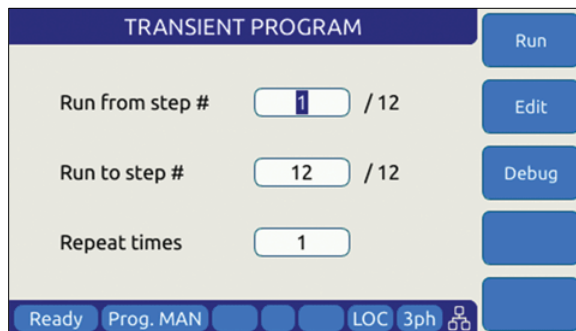

There are three user settable parameters that control execution of the transient sequence. They are:

1. Run from step #
2. Run to step #
3. Repeat times

Transients will be executed when the “Run” soft key (SK1) is pressed. If the output is **OFF** however, a message will appear indicating the output must be turned **ON** first.

The transient execution will start at the step # set and run until the Run to step value is reached. In the example above, from step #1 through step #6 inclusive.

The “Repeat times” field determines how many times the same sequence will be repeated. To run a sequence indefinitely or until manually stopped, use the shuttle to scroll down to zero or enter zero in this field using the keypad. This will set the repeat field to “indefinitely”.

The following soft keys are available on the TRANSIENT PROGRAM screen.

SOFT KEY	Description
Run (SK1)	Starts the transient from the “Run from step#” row number
Edit (SK2)	Displays the TRANSIENT VIEW edit mode screen. See section 6.6.3
Debug (SK3)	Displays the TRANSIENT VIEW debug mode screen.
Stop (SK4)	Only appears if “Repeat time” value is set to “indefinitely”. Press to stop execution manually

Table 6-19: Available TRANSIENT PROGRAM screen soft keys

6.6.5 LIST Transient Entry Modes

The AZX Series® supports two types of transient list entry modes:

- LIST STEP Entry
- LIST SEGMENT Entry

Step mode is commonly used on AC and DC power sources that support the SCPI command language as the SCPI standard defines a LIST, STEP and PULSE command syntax.

Segment mode is used on all Pacific Power sources with UPC controllers such as ASX and AMX Series. Both modes support the same capabilities however.

Note that in STEP mode, two segment entries are combined so each STEP mode entry requires two SEGMENT entries. The two transient examples below represent the same transient display in either mode.

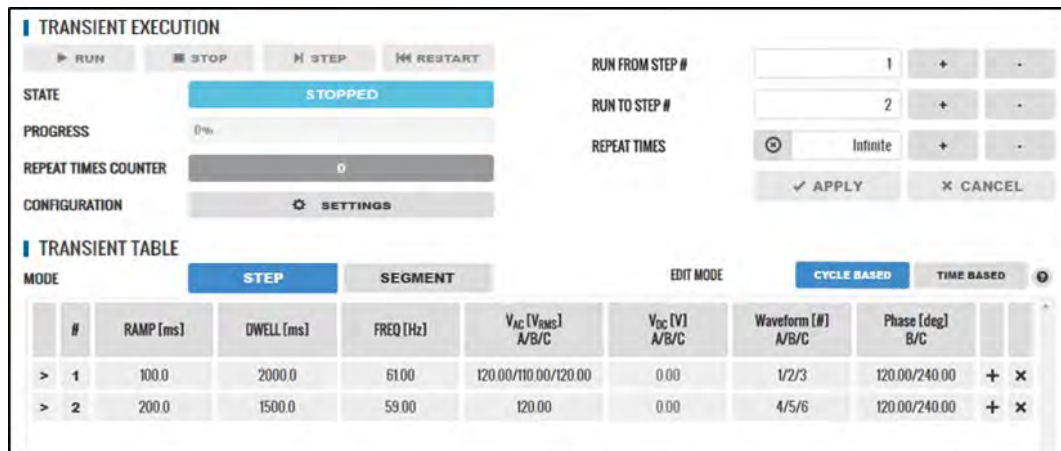

Figure 6-17: Transient shown in STEP Entry Mode

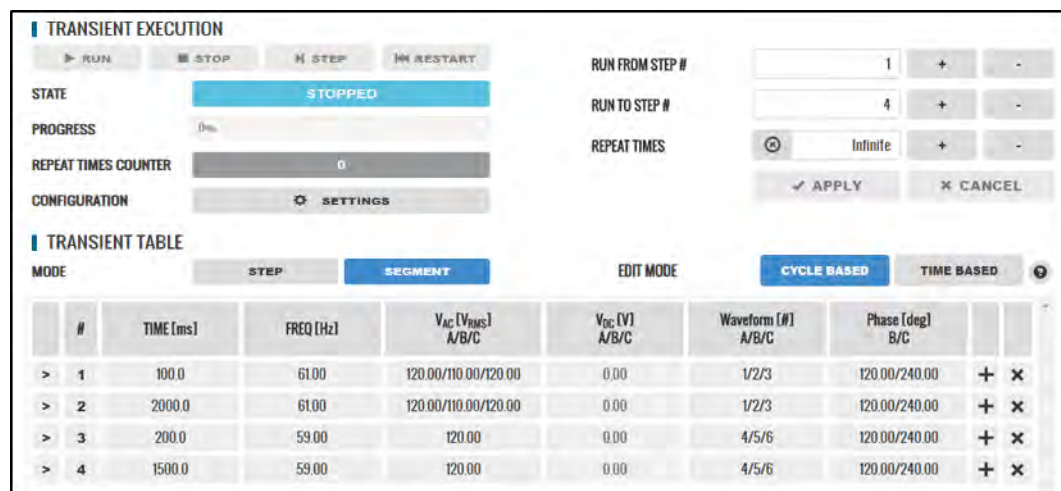

Figure 6-18: Transient shown in SEGMENT Entry Mode

6.6.6 Multiple User Waveforms in LIST Transients

Transient programs are very useful to deliver precisely controlled transitions between different waveforms to a unit under test. This means transitions from a normal AC sine wave to a non-sinusoidal or distorted waveform can be accomplished by using different waveform at different segment or step entries.

Waveforms are numbered from 1 through 200 with 1 being a fixed sine wave. All other waveform registers are user defined arbitrary waveforms.

When in AC mode, transient segments or steps can called out different waveform numbers on each of up to three phases. For each segment, up to six different waveforms can be selected. The same waveform can be repeated as of often as needed within the same transient program.

In three or split phase mode, each phase in a transient program can use its own set of up to six user-defined waveform. Thus, up to 18 different waveforms are available when in three-phase mode.

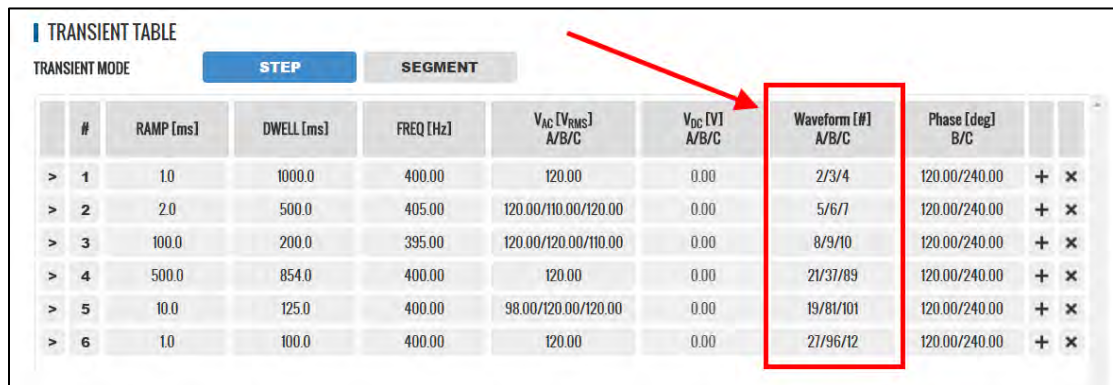

TRANSIENT TABLE									
TRANSIENT MODE									
STEP									
SEGMENT									
#	RAMP [ms]	DWELL [ms]	FREQ [Hz]	V _{AC} [V _{RMS}] A/B/C	V _{DC} [V] A/B/C	Waveform [#] A/B/C	Phase [deg] B/C		
> 1	1.0	1000.0	400.00	120.00	0.00	2/3/4	120.00/240.00	+	×
> 2	2.0	500.0	405.00	120.00/110.00/120.00	0.00	5/6/7	120.00/240.00	+	×
> 3	100.0	200.0	395.00	120.00/120.00/110.00	0.00	8/9/10	120.00/240.00	+	×
> 4	500.0	854.0	400.00	120.00	0.00	21/37/89	120.00/240.00	+	×
> 5	10.0	125.0	400.00	98.00/120.00/120.00	0.00	19/81/101	120.00/240.00	+	×
> 6	1.0	100.0	400.00	120.00	0.00	27/96/12	120.00/240.00	+	×

Figure 6-19: Available User Waveforms in Transients

6.6.7 STEP or RAMP Modes

STEP and RAMP transients are very similar except in RAMP data entry mode, each step duration is set to the minimum available time interval of 0.2 msec to obtain the smoothest possible ramp result.

In STEP mode, the user sets each increment/decrement and step dwell time.

Step transients are useful for testing over or under voltage protection circuits on AC or DC input supplies. They allow Voltage (AC or DC), Frequency and phase B or C to be steps at discrete intervals and times. An example STEP transient is shown in the screen capture below. It shows the relationship between the RAMP Parameters.

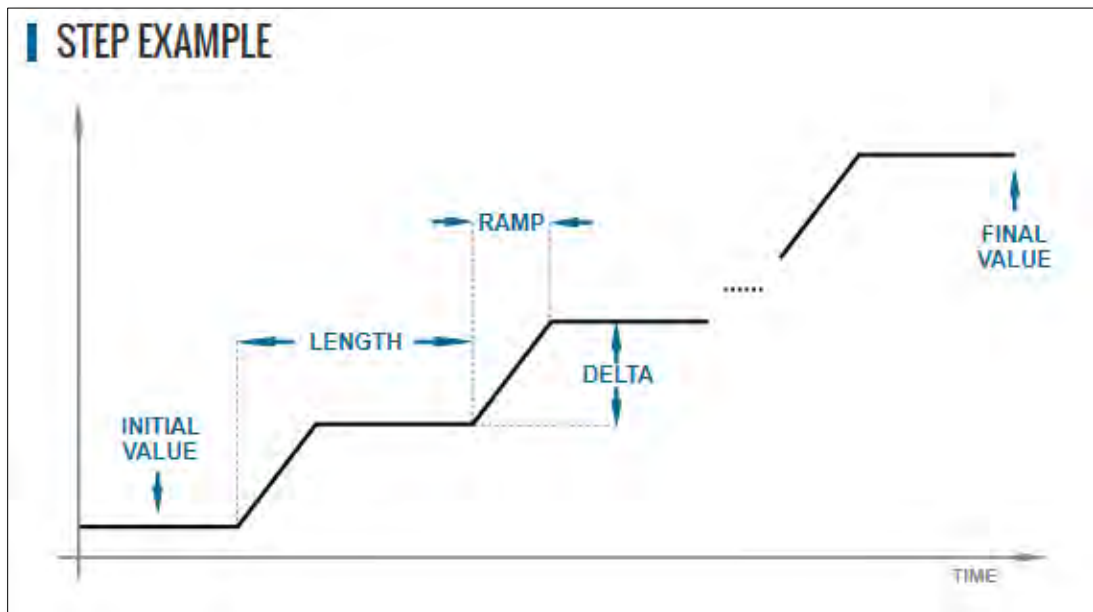

The LENGTH is the dwell time for each step level, including any ramp time. The first step starts from the INITIAL VALUE. The DELTA is the increment or decrement value for each step. The FINAL VALUE determines how many steps will be required to reach it.

Thus, the step COUNT will be:

$$\text{COUNT} = (\text{FINAL VALUE} - \text{INITIAL VALUE}) / \text{DELTA}$$

The total duration to complete the STEP transient depends on the repeat setting, length and if the Insert Initial Value check box is ON or OFF:

If Insert Initial Value = ON (default):

$$\text{DURATION} = \text{REPEAT TIMES} * (\text{COUNT} + 1) * \text{LENGTH}$$

If Insert Initial Value = OFF:

$$\text{DURATION} = \text{REPEAT TIMES} * \text{COUNT} * \text{LENGTH}$$

Step Transients can be programmed from the front panel or the LXI webserver.

6.6.8 STEP or RAMP Parameters



Step transients can be used to create discrete stair step like voltage and/or frequency changes or smooth ramps. The default ramp time is 0.2 msec. Setup is the same for Voltage or Current source except Voltage is set in Voltage Source mode and Current in Current Source mode.

Ramps can be can be programmed in three modes:

- INIDEL (0): Initial & Delta: Programmed by initial and delta values
- FINDEL (1): Final & Delta: Programmed by final and delta values
- INIFIN (2): Initial & Final: Programmed by initial and final values

Step transients can be used to step frequency, voltage AC, voltage DC, and phases.

The HOLD is ON, the last step values will be set as steady-state when the step execution ends. Duration of each step is determined by: $LENGTH = WIDTH + RAMP TIME$

The following parameters are available in a STEP VALUES screen.

PARAMETER	Range	Unit	Description
Program Mode	INIDEL, FINDEL, INIFIN	-	Program Entry Modes
Waveform	1 ~ 200		Waveform number
Voltage AC	0 ~ 440	Vrms	AC Voltage or AC Current
Voltage DC	-650 ~ + 650	Vdc	DC Voltage or DC Current
Frequency	15 ~ 1000	Hz	Frequency

Table 6-20: Available STEP Transient Parameters

The following soft keys are available on the STEP PROGRAM screen.

SOFT KEY	Description
(SK1)	
Run Screen(SK2)	Displays the STEP EXECUTION screen.
Phase ABC (SK3)	Toggles between phase A, B, C or Coupled ABC
Example (SK4)	Displays a graphical representation of the STEP parameters
Back (SK5)	Returns to previous screen

Table 6-21: Available STEP PROGRAM screen soft keys

6.6.9 STEP or RAMP Transient Execution Modes

STEP Transients can be executed as soon as they have been entered. To execute a transient, the output **must be ON**.

STEP or RAMP Transient execution is controlled from the STEP EXECUTION screen. If no STEP or RAMP transient data has been entered, no run mode soft key will be visible. In that case, you must back up to the STEP VALUES screen.

The STEP EXECUTION screen is shown below.

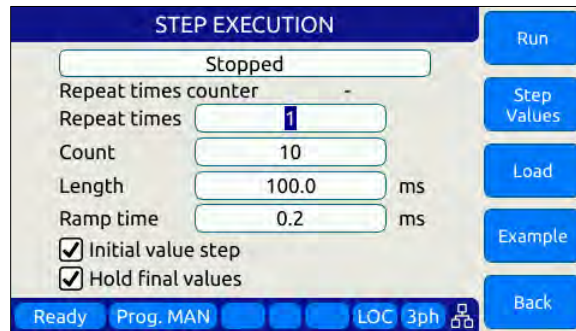

For STEP transients, Count and Length as well as Ramp time are available to be set. The “Hold final values” checkbox determines if the final state after the ramp completes remains at the final ramp values or returns to the setting before the ramp was executed.

Transients will be executed when the “Run” soft key (SK1) is pressed. If the output is **OFF** however, a message will appear indicating the output must be turned **ON** first.

The “Repeat times” field determines how many times the same STEPS or RAMPS will be repeated. To run a sequence indefinitely or until manually stopped, use the shuttle to scroll down to zero or enter zero in this field using the keypad. This will set the repeat field to “indefinitely”.

The “Count” field specifies how many steps will be taken and

The following soft keys are available on the STEP PROGRAM screen.

SOFT KEY	Description
Run (SK1)	Starts the transient from the “Run from step#” row number
Step Values (SK2)	Displays the STEP VIEW edit mode screen.
Load (SK3)	Converts STEP transient definition to standard transient segments
Example (SK4)	Displays a graphical representation of the STEP parameters
Back (SK5)	Returns to previous screen

Table 6-22: Available STEP EXECUTION screen soft keys

6.6.10 PULSE Mode

PULSE transient mode provides a quick and easy way to enter repetitive pulsed output events. This applies to AC voltage, DC voltage and or Frequency. A sample of a PULSE transient definition is shown in the screen capture below.

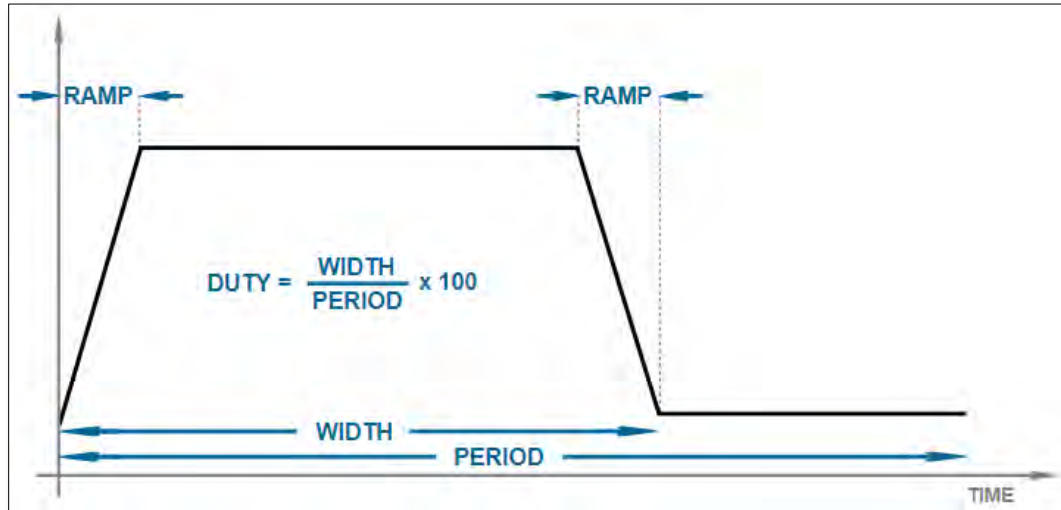

The parameters that define a PULSE transient are dependent of each other so changing one may force another to change. The semantics used for setting PULSE transients is as follows:

Parameter	Description
RAMP	Up or down ramp time
WIDTH	Duration of pulse including rising and failing ramp times
PERIOD	Total time duration for a single pulse
DUTY	Duty cycle of the pulse

The DUTY cycle is determined by the other three parameters as in:

$$DUTY = WIDTH \times 100 / PERIOD$$

6.6.11 PULSE Parameters

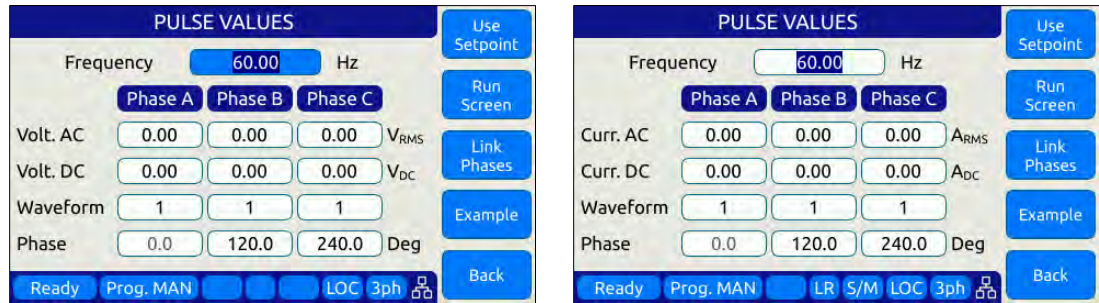

Pulse transients can be used to create repetitive events for endurance testing of AC and DC powered products. Setup is the same for Voltage or Current source except Voltage is set in Voltage Source mode and Current in Current Source mode.

The following parameters are available in a PULSE VALUES screen.

PARAMETER	Range	Unit	Description
Frequency	15 ~ 1000	Hz	Frequency
Voltage AC	0 ~ 440	Vrms	AC Voltage or AC Current
Voltage DC	-650 ~ + 650	Vdc	DC Voltage or DC Current
Waveform	1 ~ 200		Waveform number
Phase	0.0 ~ 359.9	Deg	Phase angle for phases B & C

Table 6-23: Available STEP Transient Parameters

The following soft keys are available on the PULSE VALUES screen.

SOFT KEY	Description
Use Setpoint (SK1)	Starts the transient from the “Run from step#” row number
Run Screen(SK2)	Displays the PULSE EXECUTION screen.
Link Phases (SK3)	Toggles between phase A, B, C or Coupled ABC
Example (SK4)	Displays a graphical representation of the STEP parameters
Back (SK5)	Returns to previous screen

Table 6-24: Available STEP PROGRAM screen soft keys

6.6.12 PULSE Transient Execution Modes

PULSE Transients can be executed as soon as they have been entered. To execute a transient, the output **must be ON**.

PULSE transient execution is controlled from the PULSE EXECUTION screen. If no PULSE transient data has been entered, no run mode soft key will be visible. In that case, you must back up to the PULSE VALUES screen.

The PULSE EXECUTION screen is shown below.

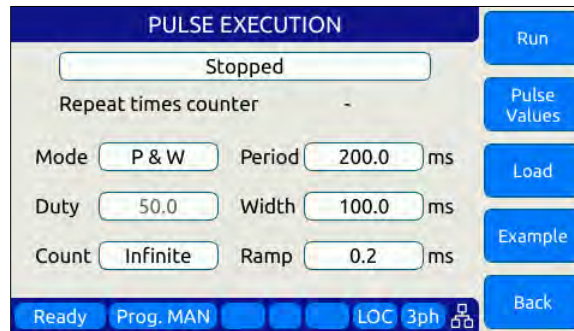

For PULSE transients, there are three user settable parameters that control execution of the transient sequence. They are:

- P&W (0): Programmed by Period & Width
- P&D (1): Programmed by Period & Duty Cycle
- W&D (2): Programmed by Width & Duty Cycle

Depending on the data entry mode selected, one of the data entry fields will be disabled and calculated based on the other parameter settings.

Transients will be executed when the “Run” soft key (SK1) is pressed. If the output is **OFF** however, a message will appear indicating the output must be turned **ON** first.

The “Count” field determines how many pulses will be run. To run a sequence indefinitely or until manually stopped, use the shuttle to scroll down to zero or enter zero in this field using the keypad. This will set the repeat field to “Infinite”.

The following soft keys are available on the PULSE PROGRAM screen.

SOFT KEY	Description
Run (SK1)	Starts the transient from the “Run from step#” row number
Pulse Values (SK2)	Displays the PULSE edit mode screen.
Load (SK3)	Converts PULSE transient definition to transient segments
Example (SK4)	Displays a graphical representation of the PULSE parameters
Back (SK5)	Returns to previous screen

Table 6-25: Available STEP PROGRAM screen soft keys

6.6.13 AUTO RMS Function – Transients

The AUTO RMS mode, if enabled, causes all transient voltages to be calculated as true RMS voltage of the waveforms used in any Segment of the Transient. This means the output voltage RMS level will remain the same, regardless of the wave shape.

When disabled, RMS calculation of substituted waveforms does not occur. Disabling AUTO RMS facilitates constant amplitude transients such as partial cycle dropouts or sub-cycle spike transients.

This mode is set by sending the **PROGram:TRANSient:AUTORMS** command over one of the Digital control interfaces.

Note: In UPC Compatibility mode, this mode is always enabled but applies to steady state only.

6.6.14 INRUSH CURRENT Mode

See Section 3.7.5, “Inrush Current Simulation Mode” on page 38 for description of this transient mode. **Note** that this mode is only available when the AZX is used in either Current Source mode or Active Load mode.

The INRUSH EXECUTION screen shows the state of operation of the inrush current sequence and the number repeats, the number of cycles and the FROM as either single peak or two peaks. Press the Inrush Values soft key to set the mode, current level, crest factor, frequency and phase offset of current with respect to AC input voltage.

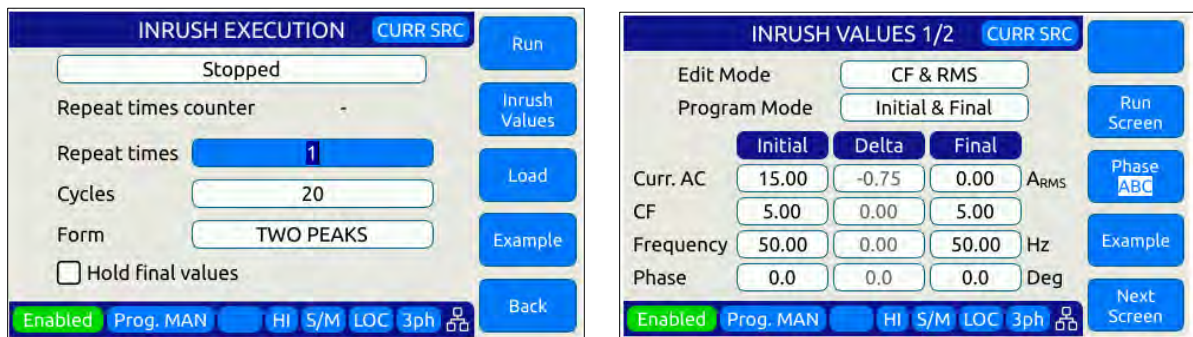

All parameters are transformed to a standard segment based transient list by the power source when the LOAD button is pressed.

The inrush mode is available for single phase, split phase and three phases.

Applies to the following modes:

- Current source
- Active load:
 - Constant current, sync and no sync
 - Constant resistance
 - Resistance RMS
 - Conductance RMS

- Constant power
 - Active power RMS
 - Apparent power RMS

Inrush transient execution is controlled from the INRUSH EXECUTION screen. It can be executed as soon as they have been entered. To execute a transient, the output must be **ON**.

Transients will be executed when the RUN Soft key is pressed. If the output is **OFF** however, a message will appear indicating the output must be turned ON first.

During transient execution, a progress indicator is visible showing percent completion.

6.6.15 INRUSH CURRENT Settings

Inrush mode settings are controlled from the INRUSH VALUES screens 1 and 2 shown below.

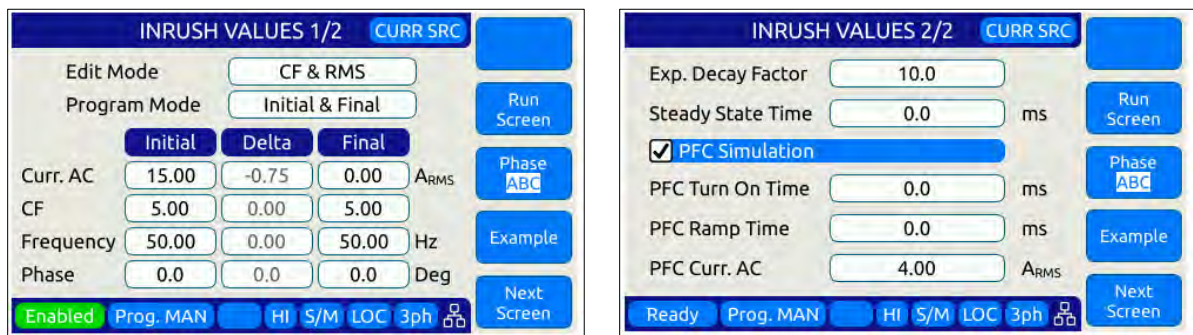

The following fields offer these settings:

Cycles: Sets the number of cycles that the inrush transient will last

Edit mode: Allows choosing the way to build the inrush transient depending on the user's needs. The possibilities are:

- Crest factor & RMS
- Crest factor & PEAK
- PEAK & RMS

Program mode: Sets the programming mode for an inrush transient. The possibilities are:

- Initial and delta values
- Final and delta values
- Initial and final values

Form mode: Allows to configure different waveform modes to use in an inrush transient. The possibilities are waveforms with one peak or two current peaks. Two peaks is common for a three phase rectifier.

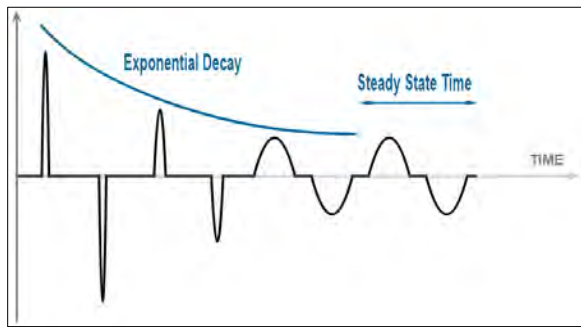

One Current Peak

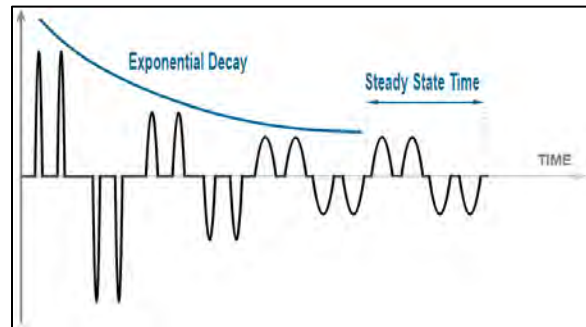

Two Current Peaks

Repeat times: This field determines how many times the same INRUSH will be repeated. To run a sequence indefinitely or until manually stopped, enter zero in this field, this will set the repeat field to “Infinite”.

Exp. Decay Factor: This exponential decay factor controls how quickly the inrush current decays. A higher factor makes it disappear faster.

PFC Simulation: This command turns on the simulation of the PFC to simulate a system commonly observed in practice. It adds a new sine waveform segment to the end of the last programmed inrush segment with the previously configured parameters.

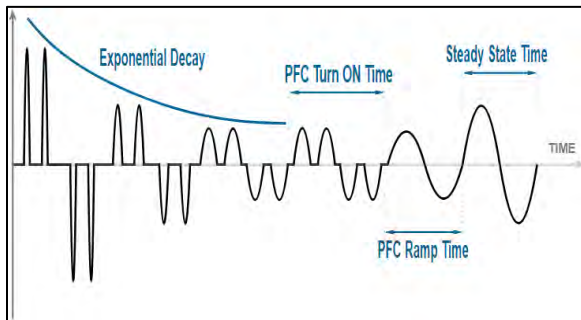

PFC Enable

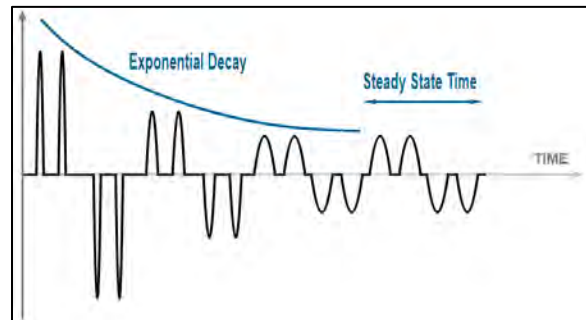

PCF Disable

Steady State Time: Allow adding a new segment at the end of the transient, with configurable time, and automatically adopts the values of the last programmed inrush segment. If the time is 0, it is disabled.

Hold Final Values: This command determines what happens to the source output after the inrush transient finishes. If ON, the last step value will be set as the steady state output when the step execution ends. If OFF, the output will revert to the original steady state setting in effect before the step transient execution.

Inrush Values

In INRUSH transient mode, the user enters an initial value, end value and delta value of all associated parameters: frequency, phase, AC current, CF and peak, depending the current configuration.

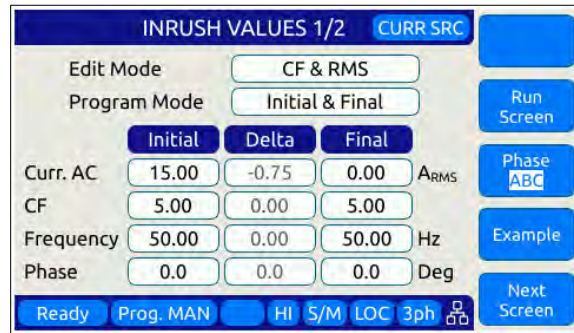

6.6.16 INRUSH CURRENT Web Browser Control

The current inrush function can be controlled from the web browser interface as well. The Inrush execution screen is located under the **Control -> Transients -> Inrush** menu but is only visible while the AZX is in either Current Source or Active Load mode. To select the mode, use the **Configuration -> Unit Settings** menu.

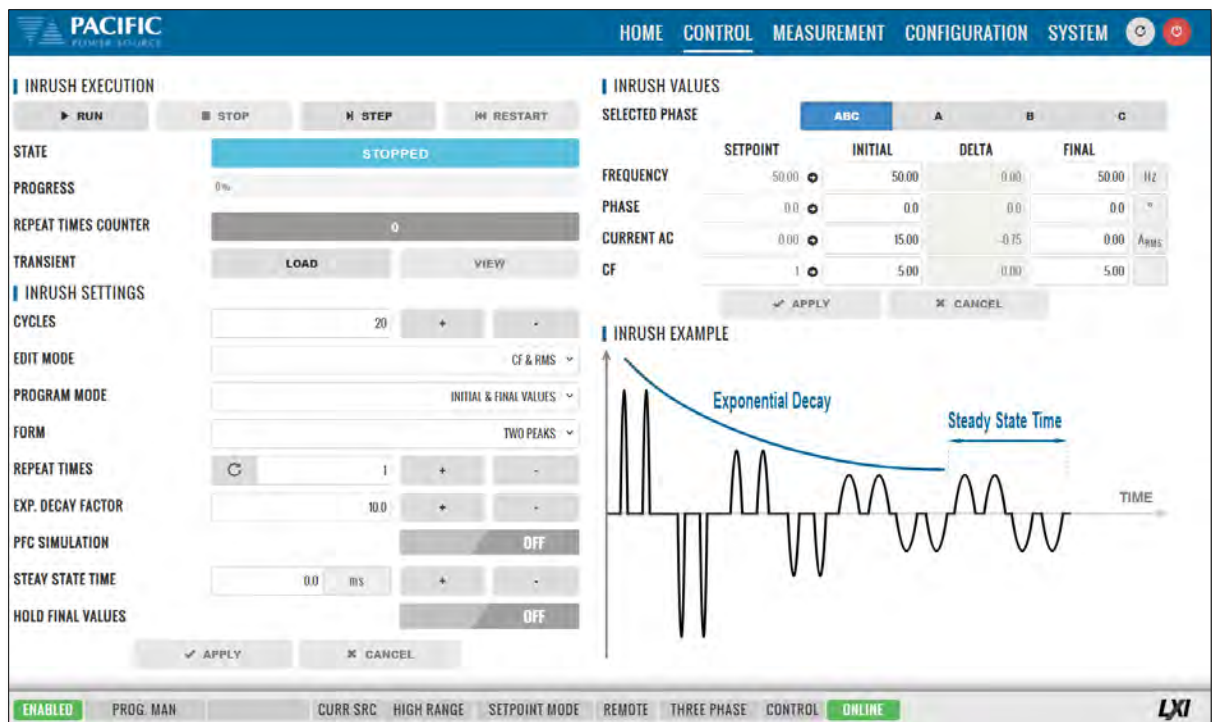

During Inrush current execution, the following progress status display is visible in the upper left corner of the Inrush Execution screen.

| INRUSH EXECUTION

▶ RUN
■ STOP
⏸ STEP
⏪ RESTART

STATE STOPPED

PROGRESS 0%

REPEAT TIMES COUNTER 0

TRANSIENT
LOAD
VIEW

Inrush Settings Browser Interface

Depending on the data entry mode selected, one of the data entry fields will be disabled and calculated based on the other parameter settings.

| INRUSH SETTINGS

CYCLES 10 + -

EDIT MODE CF & RMS v

PROGRAM MODE INITIAL & FINAL VALUES v

FORM ONE PEAK v

REPEAT TIMES
↻
1
+
-

EXP. DECAY FACTOR 1.0 + -

PFC SIMULATION ON

PFC TURN ON TIME
100.0
ms
+
-

PFC RAMP TIME
100.0
ms
+
-

PFC KVA AC
0.00
kVA
+
-

STEAY STATE TIME
0.0
ms
+
-

HOLD FINAL VALUES ON

See section 3.7.5.1, “Front panel control” above for an explanation of all setting parameters.

6.6.17 INRUSH CURRENT Capture Examples

Following current scope captures were taken using the AZX's internal advanced scope function available only from the Web browser interface.

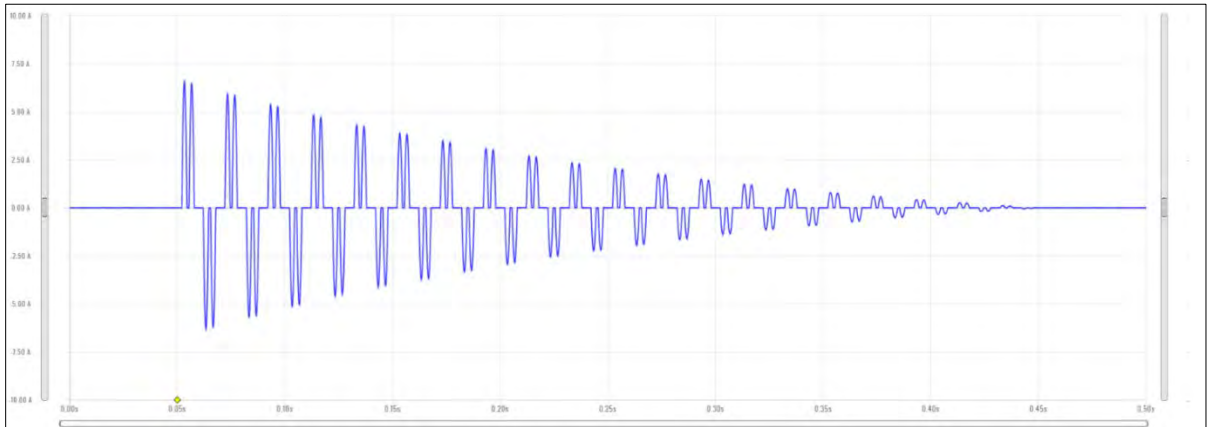

Exponential decay factor 1.0.

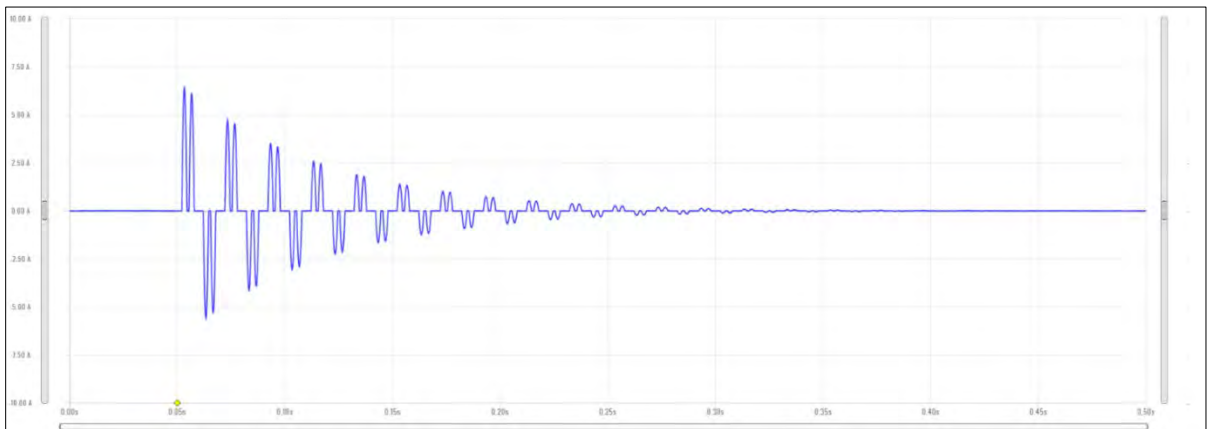

Exponential decay factor 5.0.

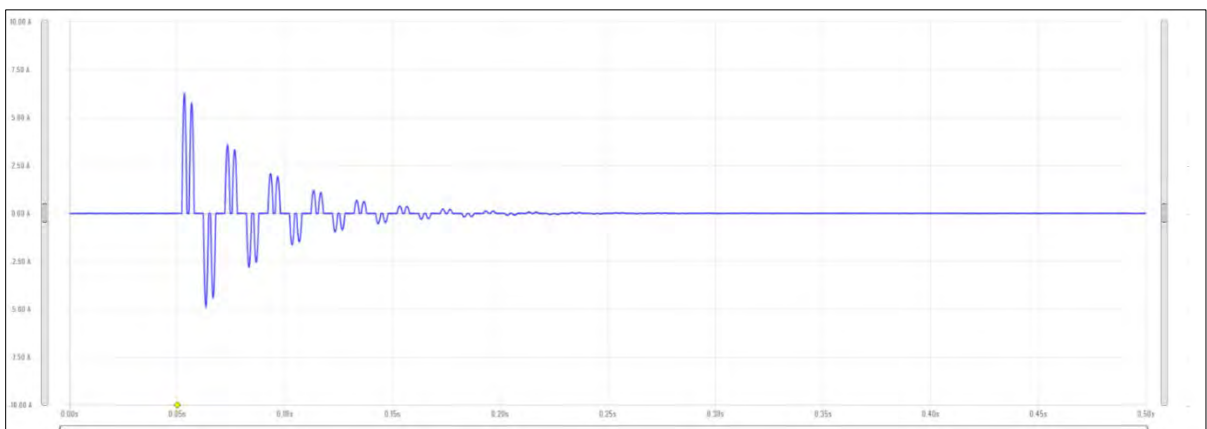

Exponential decay factor 10.0.

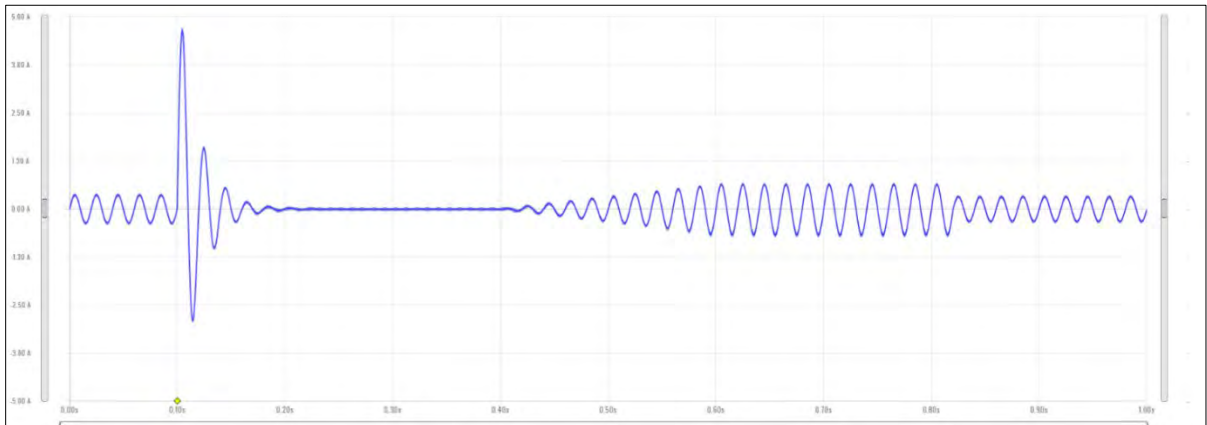

High Exponential decay factor and PFC enabled.

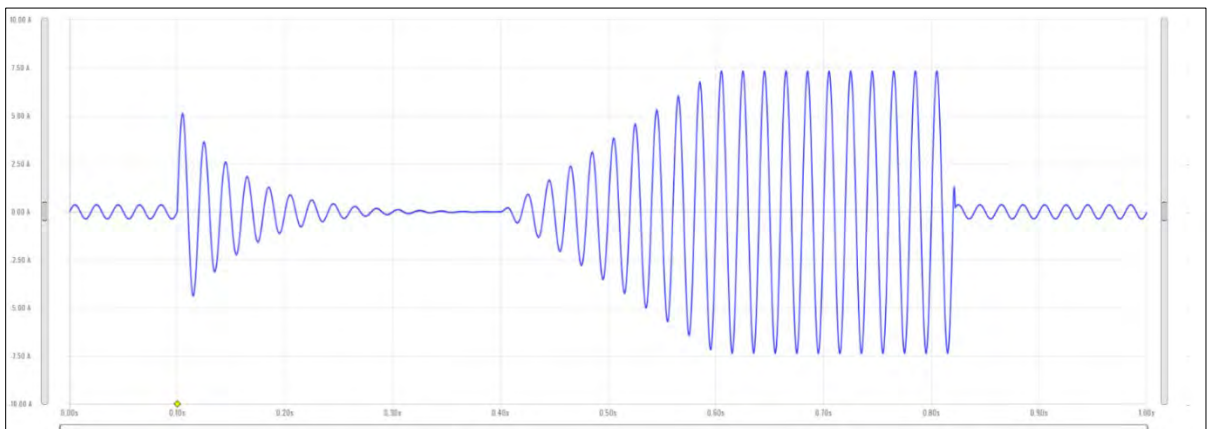

200ms of steady state time and PFC enabled.

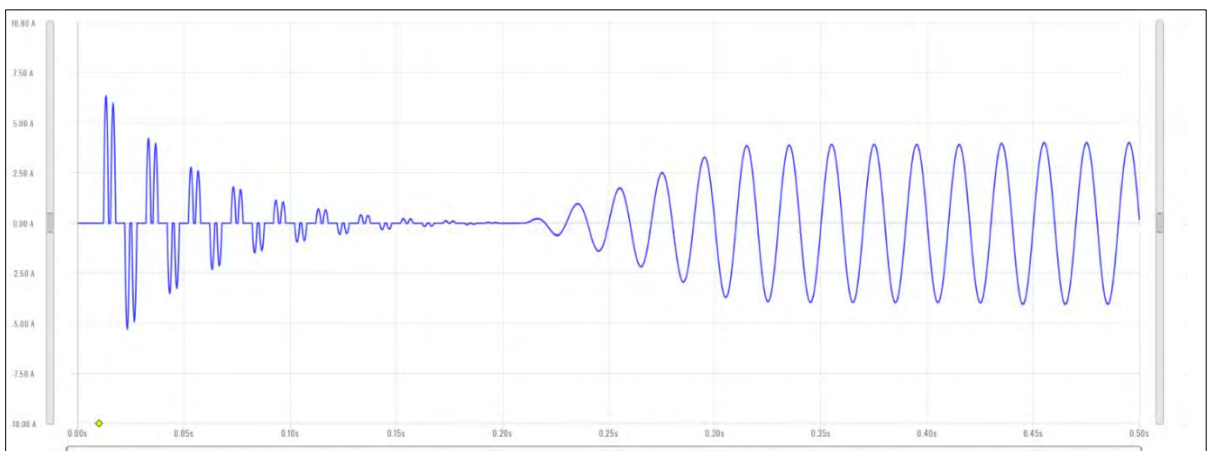

Two peaks, PFC enabled and HOLD enabled.

6.7 CONF – CONFIGURATION Screens

The CONFIGURATION screens 1 & 2 allow setting of secondary parameters functions. These include the following operation aspects:

- Configuration

Pressing the **CONF** key will display the CONFIGURATION screen as shown on the left below.

The image displays a sequence of five configuration screens from a Pacific Power Source device. The first screen, 'UNIT CONFIGURATION 1 OF 2', shows settings for Operating Mode (Voltage Source), Form (Three (ABC)), Voltage range (Low), and Mode (AC+DC). A vertical menu on the right offers options: User Limits, Ramp & Slew, Program Memory, CSC Config., and Next Screen. Arrows from these options point to the subsequent screens. The 'USER LIMITS' screen allows setting MIN and MAX values for Voltage AC (0.00 to 600.00 V_{RMS}), Voltage DC (-425.00 to 425.00 V_{DC}), and Frequency (15.00 to 1200.00 Hz). The 'RAMP TIME & SLEW RATE' screen shows Ramp time (Disabled) and active Slew rate control for Voltage AC (10.00 V_{RMS}/ms), Voltage DC (10.00 V_{DC}/ms), Frequency (5.00 Hz/ms), and Phase (5.00 Deg/ms). The 'PROGRAM MEMORY' screen shows the current program register # (MANUAL) and options to Recall, Save, Set, or Refresh. The 'CSC CONFIGURATION' screen has checkboxes for Continuous self calibration (checked) and Fault on saturation (unchecked), along with a Max CSC gain of 1.15.

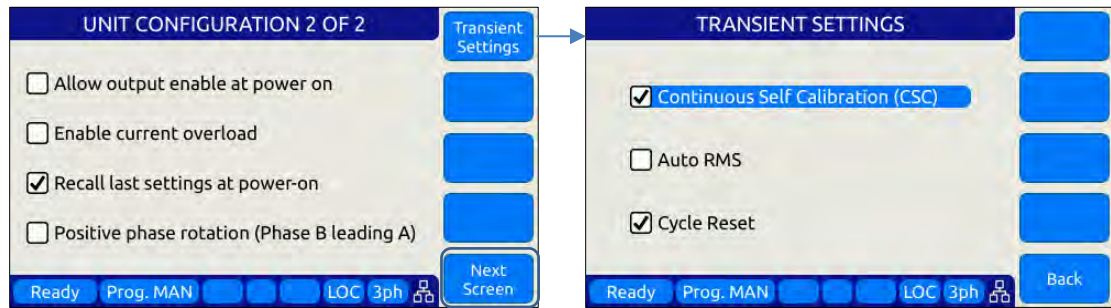

All other system related screens can be accessed using the SYST menu key. (Refer to Section 6.7.7).

6.7.1 UNIT CONFIGURATION Screens

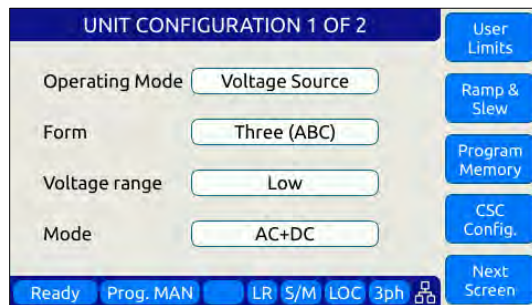

Voltage Source Mode

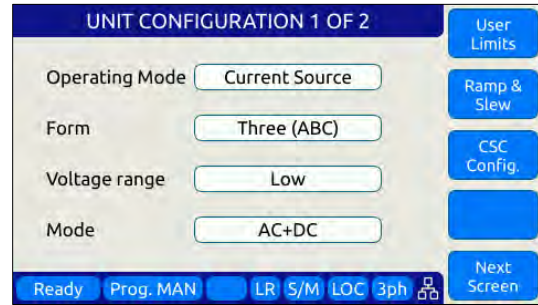

Current Source Mode

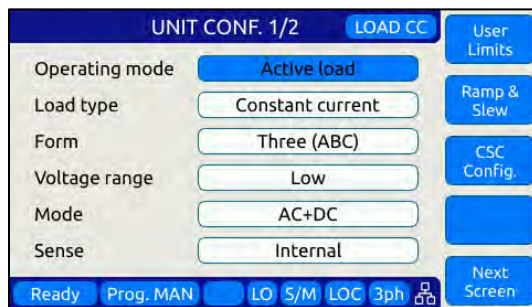

Electronic Load Mode

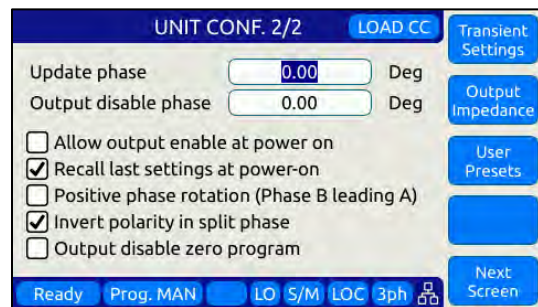

Configuration 2 of 2

The following settings can be changed from the UNIT CONFIGURATION screens:

UNIT CONFIGURATION 1 OF 2-----

Operating Mode

This field selects the mode of operation for the AZX.

Available modes are:

- VOLTAGE SOURCE
- CURRENT SOURCE
- ACTIVE LOAD (Requires Option L)

Note that program and setting screens may differ depending on the selected Operating mode. For example, in

VOLTAGE SOURCE mode, the user can set Voltage and Frequency. In CURRENT MODE, the user can set Current and Frequency. In ACTIVE LOAD mode, the user set the expected input voltage frequency to speed up synchronization as well as Current or Impedance depending on the selected Load Type.

Note: Operating Mode can NOT be changed while the OUTPUT ENABLE is ON. Turn OFF Output Enable before changing Operating Mode.

Note: When changing from Source to Load mode, it is generally necessary to connect a different EUT.

Load Type

In ACTIVE LOAD Mode, this field allows selecting either Constant Current mode (CC) or Constant Impedance Mode (CZ). This field is not visible in either source mode.

Form

This field determines the phase mode of operation.

Available settings are:

FORM1 One Phase

FORM2 Split Phase

FORM3 Three Phase

FORM4 Two separate outputs (Source) or inputs (Load) (AB)

FORM5 Three separate outputs (Source) or inputs (Load) (AB)

Note that for one phase mode, it is necessary to short the three output phases together using the optional single-phase output connector accessory. Alternatively, the user can use an external terminal block to tie the three phase outputs together.

Note: When switching from one phase to three phase modes, a warning will be displayed to make sure the end-user removes any common connections between the three phase outputs.

Voltage Range

The power source has dual voltage range and uses a constant power mode on both. If operation to 440Vac/650Vdc is desired, this field should be set to High.

Mode

VOLTAGE & CURRENT Mode: Sets the output mode to AC, DC or AC+DC.

ACTIVE LOAD Mode: Sets the input mode to AC, DC or AC+DC.

Update Phase

Sets the phase angle at which output voltage and frequency changes will take place on phase A. This setting applies to

both steady state output changes and to the start of a transient program execution. It also applies to the OUTPUT ENABLE and DISABLE function key on the front panel. Changes on phases B and C will take place at the same moment in time but at phase angles that are shifted from phase A by the phase angles programmed for phase B and C.

Coupling

This field selects the output coupling mode of the power source. Unless an optional output transformer is installed with the power source, this field is always fixed to DIRECT. Direct coupling output mode supports either AC mode, DC mode or a combination of AC and DC output to be programmed. If the optional transformer is installed, the AZX model number will show “AZXT” to indicate the presence of the output transformer. To use the output transformer coupled range, selected XFMR (xxxV) in this field. The voltage indication may vary based on the transformer ration of the installed output transformers.

Access to other utility screens is available from the UNIT CONFIGURATION screen through the soft keys. The table below lists the available soft keys on the UNIT CONFIGURATION screen.

SOFT KEY	Description
User Limits (SK1)	Displays SETUP MENU screen. Refer to section 0
Ramp & Slew (SK2)	Displays SLEW RATE MENU screen. Refer to section 6.7.3
Program Memory (SK3)	Displays PROGRAM MEMORY screen. Refer to section 6.7.4 (Voltage Source mode only.)
CSC Config. (SK3 or SK4)	Display CSC setting screen
Next Screen (SK5)	Toggle to alternate UNIT CONFIGURATION screen

Table 6-26: Available UNIT CONFIGURATION 1 screen soft keys

UNIT CONFIGURATION 2 OF 2 -----

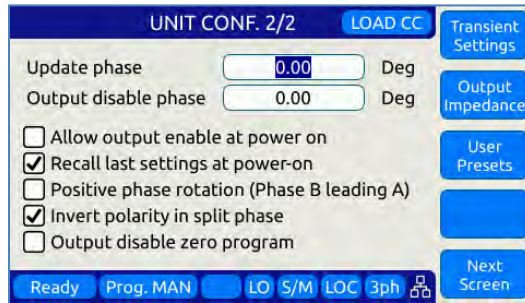

- Update phase** Programmed changes in voltage (Voltage source mode) or current (Current source & Load modes) will occur at this phase angle on phase A.
- Output Disable Phase** The output relay will be opened at the phase angle specified.
- Allow output enable at power on** This mode if set, causes the output to turn on at power up.
- Recall last settings at power-on** When checked, this mode will cause the last settings that were in effect when the power source was last turned off to be recalled at power on. This allows a user to resume operation without having to set up again between power on/off events.
- Positive phase rotation** When checked, the phase rotation in three phase mode will be set to A -> C -> B corresponding to positive phase rotation for three phase AC motors. To select negative phase rotation, uncheck this option.
- Invert polarity in split phase** When checked, the AC waveform in split-phase mode of operation is shifted 180° (inverted).
- Output disable zero program** When checked, the programmed voltage is first set to zero voltage when pressing the Output Enable button or executing the OUTP OFF command. This allows any energy stored in the EUT to dissipate into the low impedance output of the power source before the relay disconnects the load.

Access to other utility screens is available from the UNIT CONFIGURATION screen through the soft keys. The table below lists the available soft keys on the UNIT CONFIGURATION screen.

SOFT KEY	Description
Transient Settings (SK1)	Display Transient Configuration Settings
Output Impedance (SK2)	Program Output Impedance R and L values.

SOFT KEY	Description
User Presets (SK3)	Access to user defined preset value settings for output programming soft keys
Next Screen (SK5)	Toggle to alternate UNIT CONFIGURATION screen

Table 6-27: Available UNIT CONFIGURATION 2 screen soft keys

6.7.2 USER LIMITS SETTINGS Screen

This screen allows programming user defined voltage and frequency upper and lower limits to prevent an operator from accidentally programming output settings that could be damaging to a unit under test.

For example, when testing a 50 Hz transformer, a lower frequency limit setting of 47 would prevent output frequency programming of values that could cause the transformer to saturate.

The also applies to voltage where a high output voltage could damage a unit under test that was not designed to handle high AC or DC input voltages.

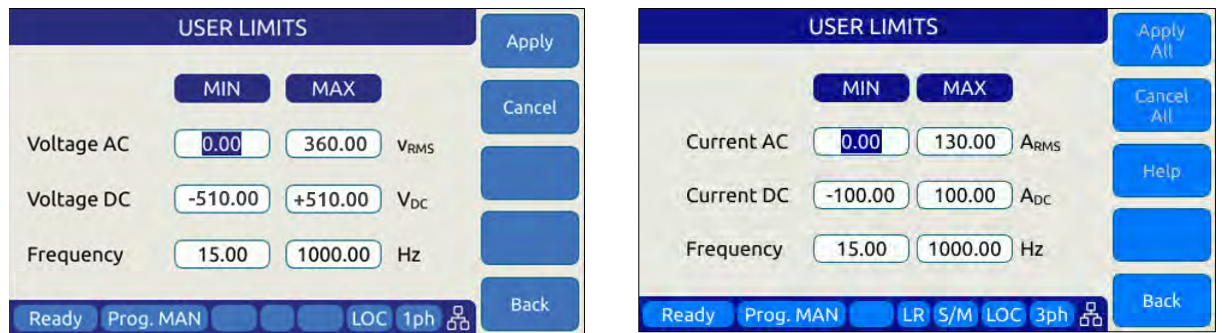

Figure 6-20: USER LIMIT SETTINGS Screen

The following parameters can be set from this screen:

Voltage or Current AC Lower and Upper Vrms/Arms set limits for AC programming.

Voltage or Current DC Lower and Upper Vdc/Adc set limits for DC programming.

Frequency Lower and Upper limits for Frequency programming.

The soft keys on the USER LIMITS SETTINGS screen provide access to additional functionality as listed in the table below.

SOFT KEY	Description
Apply (SK1)	Accepts new settings and returns to previous screen.
Cancel (SK2)	Returns to the previous screen.
-	
-	

SOFT KEY	Description
Back (SK5)	Returns to the previous screen.

Table 6-28: Available USER LIMITS SETTINGS screen soft keys

6.7.3 RAMP TIME & SLEW RATE SETTINGS Screen

This screen allows programming of the update ramp time or individual voltage (Voltage Source mode), Current (Current Source or Active Load modes) and frequency slew rates. These settings are applied when changing output settings. Ramp time and slew rate settings are mutually exclusive so Ramp time must be disabled in order to program individual voltage, frequency and phase update rates. Setting a slew rate other than the maximum value allows voltage or current and frequency changes to occur at a controlled rate of change. The Ramp time when enabled applies to any setting change equally.

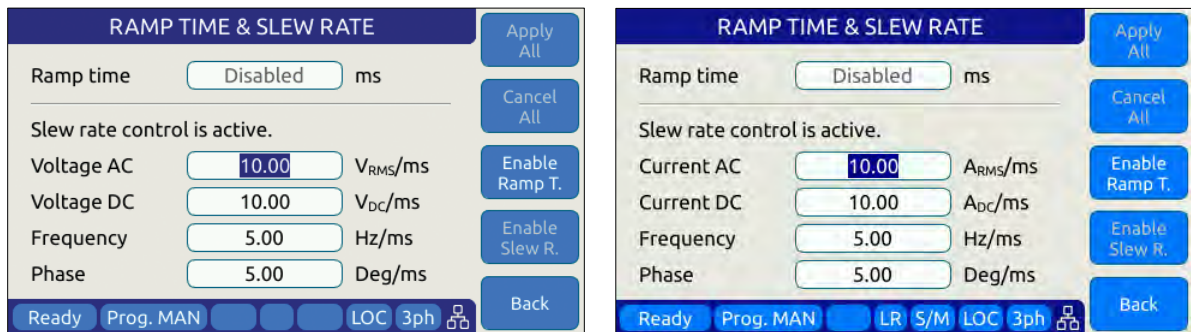

Figure 6-21: RAMP TIME & SLEW RATE SETTINGS Screens

The following parameters can be set from this screen:

- Ramp time** Sets the time over which output changes will take place. For the time set, output changes will ramp from their previous set value to the new set value. When **DISABLED**, changes will occur at the programmed slew rate settings in the SLEW RATE SETTING screen, as both cannot be in effect at the same time. Settings Slew Rate settings provide control over individual parameters whereas the RAMP TIME setting applies to all parameters (F, Vac or Iac, Vdc or Idc and Phase) changes equally.
- Voltage or Current AC** AC Voltage slew rate in Vrms/msec, AC Current slew rate in A/msec. Available range is 0.01 Vrms/ms through 440 Vrms/ms for voltage.
- Voltage or Current DC** DC Voltage slew rate in Vdc per msec. DC Current slew rate in A/msec. Available range is 0.01 Vdc/ms through 1300 Vdc/ms for voltage.
- Frequency** Frequency slew rate in Hz per msec. Available range is 0.01 Hz/ms through 1000 Hz/ms.

Phase Phase angle slew rate in Degrees per msec. Available range is 0.01 Deg/ms through 359.91 Deg/ms

NOTE: Programmed Slew Rate settings will only take effect when the RAMP TIME setting is **DISABLED**.

The soft keys on the SLEW RATE SETTINGS screen provide access to additional functionality as listed in the table below.

SOFT KEY	Description
Apply All (SK1)	Applies all changes made (highlighted in grey) and returns to previous screen.
Cancel All (SK2)	Cancels all changes (highlighted in grey), sets slew rates back to prior settings and returns to previous screen.
Enable Ramp T.	Enables Ramp time, disables Slew rate settings
Enable Slew R.	Enable Slew Rate settings, disables Ramp time
Back (SK5)	Returns to the previous screen.

Table 6-29: Available RAMP TIME & SLEW RATE SETTINGS screen soft keys

6.7.4 PROGRAM MEMORY Screen

The Program Memory menu allows saving and recalling of instrument setups in non-volatile memory registers. Setups include all steady state parameters, limits, operating modes and transient list if programmed.

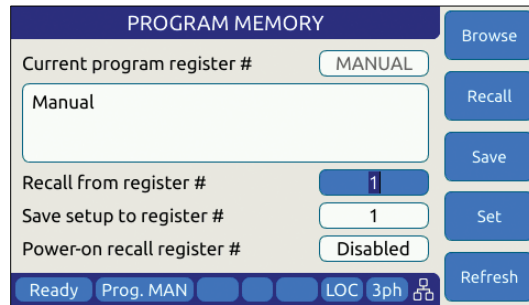
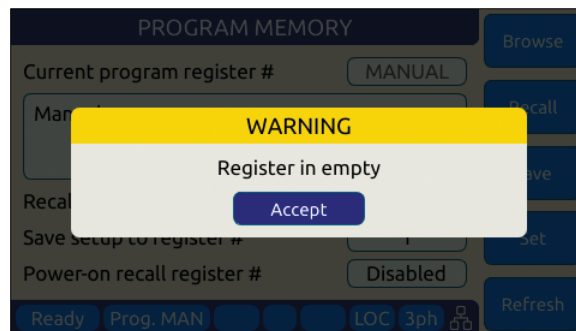

Figure 6-22: PROGRAM MEMORY screen

There are 10 setup registers numbered from 1 through 10. Use the shuttle to select either the Recall or Save field and press the shuttle to enter edit mode. Once the correct number is selected, press ENTER to confirm.

- Recall from register #** Recalls setup from selected register. If register is empty, an error message will be displayed and no setting will be recalled.
Note: If a register location is empty, an error message will be displayed.



- Save setup to register #** Saves setup in effect to selected register number. If this register already contained a saved setup, it will be overwritten.

- Power recall register #** Determines which register number setup is recalled at power-up. Using this feature, the user can determine the power-on default settings of the power source.

The soft keys on the PROGRAM MEMORY screen provide access to additional functionality as listed in the table below.

SOFT KEY	Description
Browse(SK1)	Allows browsing for a particular register’s content.
Recall (SK2)	Recalls selected Register setup content
Save (SK3)	Saves setup to selected Register
Set (SK4)	Sets output to selected Register content
Refresh (SK5)	Return to previous screen

Table 6-30: Available SLEW RATE SETTINGS screen soft keys

6.7.5 CSC CONFIGURATION Screen

The CSC CONFIGURATION menu allows the Continuous Self Calibration mode to be enabled. This feature is used to improve load regulation of the power source by continuous measurement of the output phase voltage(s) and adjusting the internal set points as needed to maintain close to zero load regulation. If the CSC is unable to get the output to the set point, an error will be generated. This error can be disabled by unchecking the “Fault on saturation” check box.

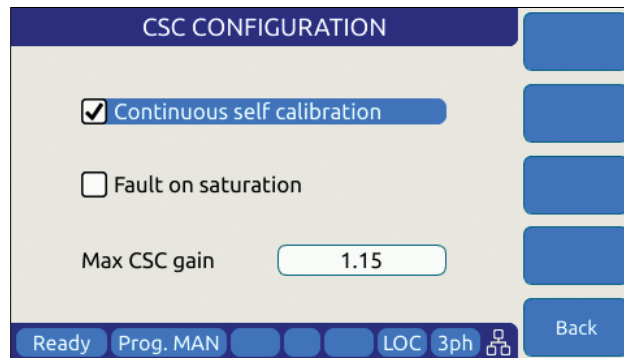

Figure 6-23: CSC CONFIGURATION screen

The soft keys on the CSC CONFIGURATION screen are listed in the table below

SOFT KEY	Description
-	
-	
-	
-	
Back (SK5)	Return to previous screen

Table 6-31: Available CSC CONFIGURATION screen soft keys

6.7.6 TRANSIENT SETTINGS Screen

The TRANSIENT SETTINGS screen defines operation of transient execution.

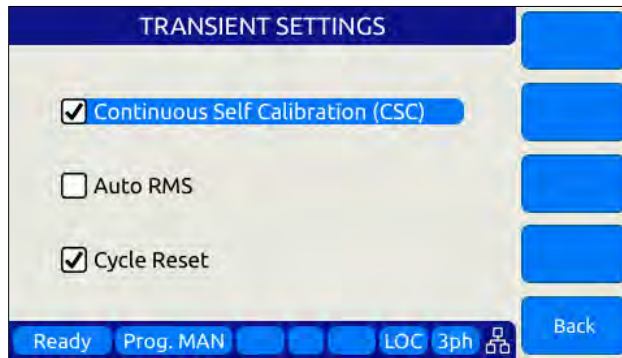

Available settings are:

- Continuous Self Calibration** This CSC mode is similar to the CSC mode for steady state operation but applies to transient mode.
- Auto RMS** This field allows enabling or disabling of the Auto RMS mode for transient mode operation. Refer to section 6.6.6, “AUTO RMS Function – Transients” for further details.
- Cycle Reset** When enabled, the CYCLE RESET mode will cause repeated executions of the transient as determined by the repeat count or the continuous execution setting to re-sync to the start phase angle set for the start of each transient. When disabled, repeats of the transients start immediately after the previous execution completes with not resync. With Cycle Reset on, there may be up to one period of the AC frequency of delay added between successive runs.
Note: In UPC Compatibility mode, Cycle Reset is default on.

The soft keys on the TRANSIENT SETTINGS screen are listed in the table below

SOFT KEY	Description
-	
-	
-	
-	
Back (SK5)	Return to previous screen

Table 6-32: Available TRANSIENT SETTINGS screen soft keys

6.7.7 OUTPUT IMPEDANCE Screen

The OUTPUT IMPEDANCE screen allows the output impedance of the power source to be programmed.



Following parameters can be set from this screen:

Mode: Selects between Real time or RMS mode.

- Real time:** Real-time mode uses a fast responding method to control output impedance. This mode the faster one. It works at the signal level implanting a digital filter, equivalent to a resistor and an inductor, in series with the output. It emulates a phase shift and waveform distortion similar to an actual LR impedance at frequencies within the bandwidth of the output amplifier (around 3kHz). CSC must be disabled to use this mode.
- RMS:** RMS Mode is slower as it relies on the measured RMS output voltages and currents to make adjustments. It is based on steady state RMS measurements, not on real-time signals, so it does not affect output waveform and phase shift. It also allows the CSC mode to remain enabled, so at a steady state level it provides a very accurate voltage drop (on an RMS measurement level).

Resistance: Sets the Resistive value for the programmable impedance.

Impedance: Sets the Inductive value for the programmable impedance.

The soft keys on the OUTPUT IMPEDANCE screen are listed in the table below

SOFT KEY	Description
-	
-	
-	
-	
Back (SK5)	Return to previous screen

Table 6-33: Available PROGRAMMABLE IMPEDANCE screen soft keys

6.7.8 USER PRESETS Screen

The USER PRESETS screen allows the soft key set values for output programming that appear in the PROGRAM screen to be changed to setting values preferred by the user.

Presets can be defined for the following output settings:

- VOLTage[:AC]
- VOLTage:DC
- FREQuency
- PHASe
- CURRent:LIMit
- POWer:LIMit
- KVA:LIMit

6.7.8.1 AC and DC Voltage Soft keys



SK #	Value	Unit
SK #1	115.00	V _{RMS}
SK #2	20.00	V _{RMS}
SK #3	300.00	V _{RMS}
SK #4	MAX 360.00	V _{RMS}

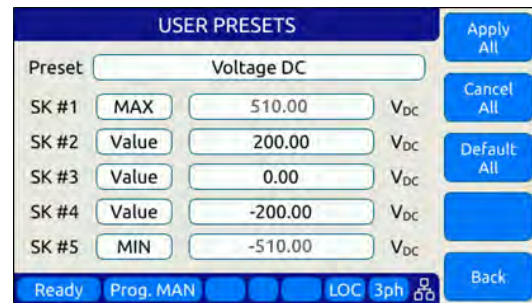

SK #	Value	Unit
SK #1	MAX 510.00	V _{DC}
SK #2	200.00	V _{DC}
SK #3	0.00	V _{DC}
SK #4	-200.00	V _{DC}
SK #5	MIN -510.00	V _{DC}

6.7.8.2 Frequency and Phase Soft keys



SK #	Value	Unit
SK #1	50.00	Hz
SK #2	60.00	Hz
SK #3	400.00	Hz
SK #4	800.00	Hz
SK #5	1200.00	Hz



SK #	Value	Unit
SK #1	0.00	Deg
SK #2	90.00	Deg
SK #3	120.00	Deg
SK #4	180.00	Deg
SK #5	240.00	Deg

6.7.8.3 Current Limit Soft keys



6.7.8.4 Power and VA Limit Soft keys



For each parameter, the user will be prompted to confirm soft key value setting changes. See dialog to the right. ▶

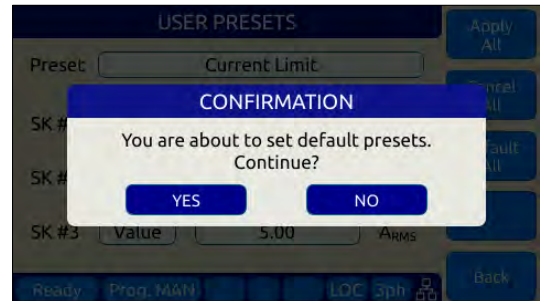

SOFT KEY	Description
Apply All (SK1)	Applies values entered by user.
Cancel All (SK2)	Cancel all changes made.
Default All (SK3)	Sets all soft key settings for selected parameter to factory defaults.
-	
Back (SK5)	Refreshes screen

6.8 SYST – SYSTEM Screens

The System screens allow setting of secondary system level functions that are used less often than the first four screens. This generally involves setting system level operation modes and parameters to tailor the instruments operation to the user’s specific requirements and operating environment. These include the following areas:

- Remote Control Interfaces
- System level settings, logs and firmware updates
- Calibration
- Parallel Operation
- Options if any

Pressing the **SYST** key will display the first of two CONFIGURATION screens as shown below.

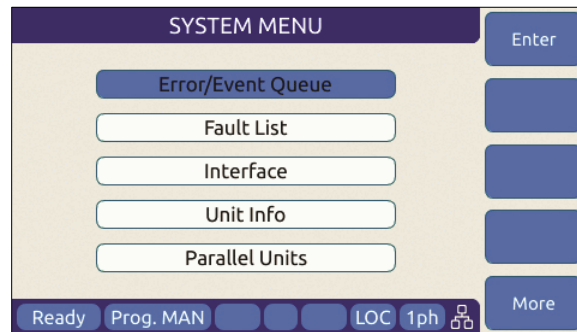

Figure 6-24: SYSTEM MAIN MENU 1

The **More** soft key will allow moving back and forth between the two main SYSTEM screens.

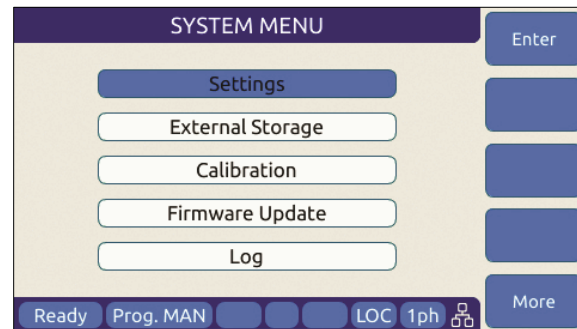

Figure 6-25: SYSTEM MAIN MENU 2

Selections on each screen are made by scrolling through the available entries using the shuttle knob. Pressing the **Enter** soft key, ENTER key or shuttle will display the selected highlighted entry screen.

6.8.1 SYSTEM MENU 1

The first SYSTEM MENU allows for selection of the following functions:

- Error/Event Queue Screen
- Fault Information Screen
- Interface Settings Screen
- Unit Information Screen
- Connected Units Screen
- SCPI Console



Each screen is covered in subsequent sections.

6.8.2 SYSTEM MENU 2

The second SYSTEM MENU allows for selection of the following functions:

- System Settings Screen
- Memory Management Screen
- Calibration Screen
- Firmware Update Screen
- Remote Support Screen



Each screen is covered in subsequent sections.

6.8.3 ERROR / EVENT QUEUE Screen

The Error and Event queue shows the history of any errors or events that have occurred since the last time the error queue was cleared.

The error queue can be cleared using a SCPI command over any of the remote control interfaces or by pressing the “Clear Queue” soft key while on this screen.

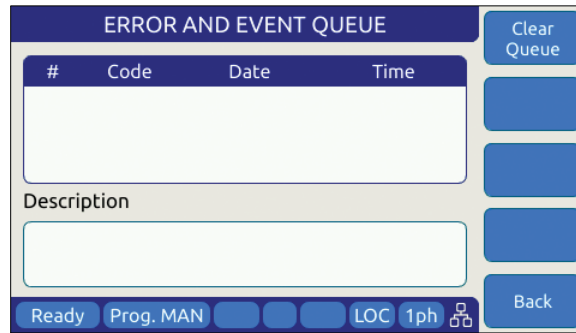

Figure 6-26: ERROR & EVENT QUEUE Screen

6.8.4 FAULT INFORMATION Screen

The fault list shows any logged internal operation faults. This information may be useful when trouble shooting any issues with the power source. In that even, customer service may request this information from the end user or request access to the instrument through the LAN interface for further diagnostics.

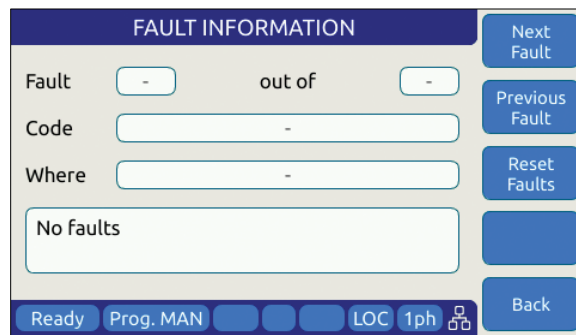

Figure 6-27: FAULT INFORMATION screen

6.8.5 INTERFACE Screen

The INTERFACE SETUP screen allows access to the setup parameter of any of the available remote control interfaces.

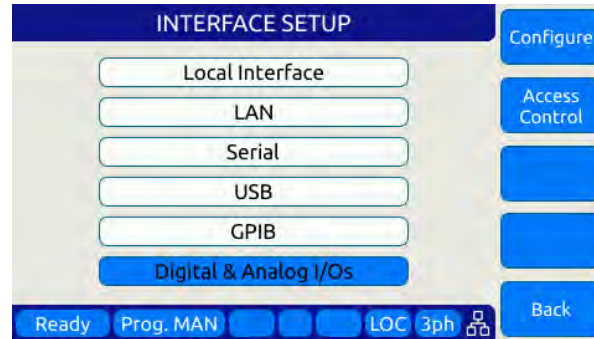

Figure 6-28: INTERFACE SETUP Screen

Available selections are:

- Local Interface (Relates to front panel operation)
- LAN – Ethernet Interface Setup
- Serial – RS232 Serial Interface Setup
- USB – USB Interface Setup
- GPIB – GPIB Interface Setup (Models with “G” option only)
- Digital & Analog I/O Setup

Each section is covered in subsequent sections.

6.8.5.1 LOCAL INTERFACE 1 OF 2

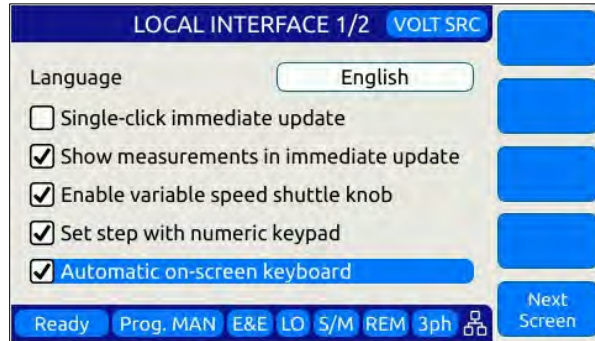

Several aspects of front panel operation can be configured by the user from this screen. This relates primarily to the language selection and operation of the shuttle knob, which has three distinct functions:

1. Scrolling values up or down
2. Single Click push function
3. Double Click push function

Parameters available to set are as follows:

Language

Available language selections are:

- English (default factory setting)
- Chinese.

Language can be switched by pressing the shuttle while on the language field and scrolling between available selections. Press ENTER to confirm selection.

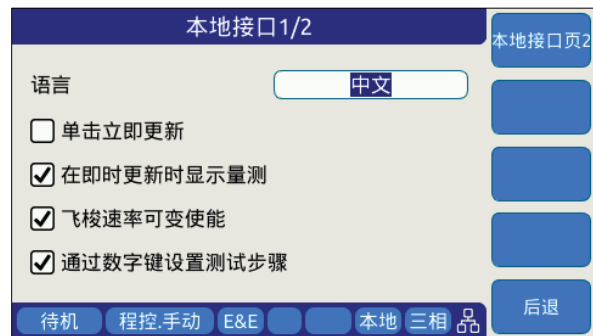

Single-Click Immediate Mode

Enters Immediate Mode upon single depression of shuttle knob. Immediate mode means value changes occur immediately on the output of the power source. When unchecked, a double click of the shuttle knob is required to enter this mode.

- Show Measurements in Immediate Mode** When checked, entering immediate mode will result in the Measurement screen being display with the changing parameter showing in the title bar. This allows monitoring of all output measurements while slewing voltage, current of frequency.
- Enable variable speed shuttle knob** When selected, the speed of rotating the shuttle knob will increase the step size of the parameter being changed. If unchecked, changes occur at a fixed step size (resolution).
- Set step with numeric keypad** When set, the numeric keypad can be used to increment or decrement the step size of the shuttle knob. Digits 9 to 1 our use to change from largest step size (9) to smallest step size (1) and any step size in between.
- Automatic on-screen keyboard** This selection enables the on-screen Qwerty keyboard pop-up when the scroll knob is pressed once. When turned OFF, it is still available but requires double clicking the knob. This touch keyboard allows entering of alpha numeric parameters and also supports number value entries. See next section for details.

The following soft keys are available from the LOCAL INTERFACE setup screen:

SOFT KEY	Description
Local Inter. Page 2. (SK1)	Toggle to LOCAL INTERFACE 2 OF 2 screen
-	
-	
-	
Back (SK5)	Returns to previous screen

Table 6-34: Available USER INTERFACE screen soft keys

6.8.5.2 TOUCHSCREEN KEYBOARD

The on-screen Touchscreen Keyboard features allow entry of alpha numeric values such as names in text entry fields from the front panel. It pops up when the scroll knob is pressed once is set to on or double clicked when set to off in the LOCAL INTERFACE 1 OF 2 Screen.

It is mainly intended for use in text entry fields as the numeric keypad is always available for numeric entries. These are several keyboards available and the default type depends on the data entry field the cursor is on when the shuttle knob is pressed. The number of text characters in each keyboard is limited by the field type.

Key Descriptions

The following keys are supported:



1. Shift: Allows switching between lowercase and uppercase letters, numbers and symbols.
2. 123/ABC: Allows switching from letters to numbers and symbols or vice versa.
3. Return: Places the cursor at the end of the text.
4. Backspace: Deletes the previous character depending on the cursor position
5. Apply: Closes the keyboard and apply text to the field.
6. Clear: Clears all text.
7. Arrows: Allows moving through the text.
8. Cancel: Discards text and close the keyboard

Available Qwerty keyboard Types:

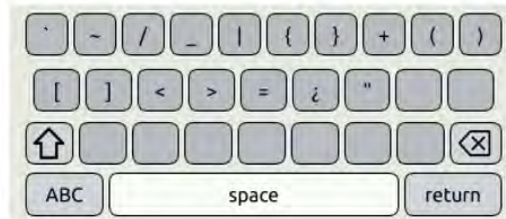
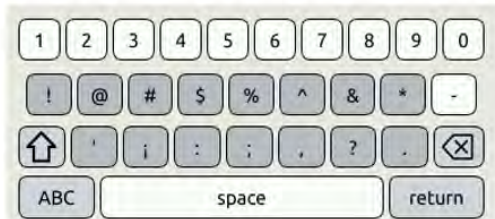
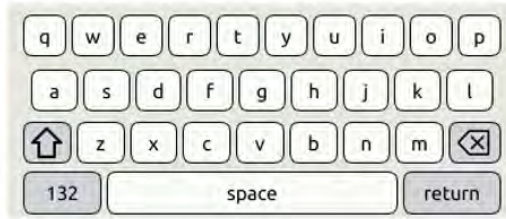
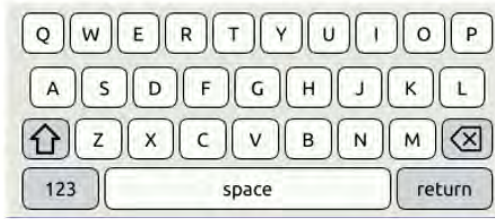

Web Browser Front Panel Mode.

The same on-screen keyboard functions are available from the Web browser interface via LAN or USB as shown below.

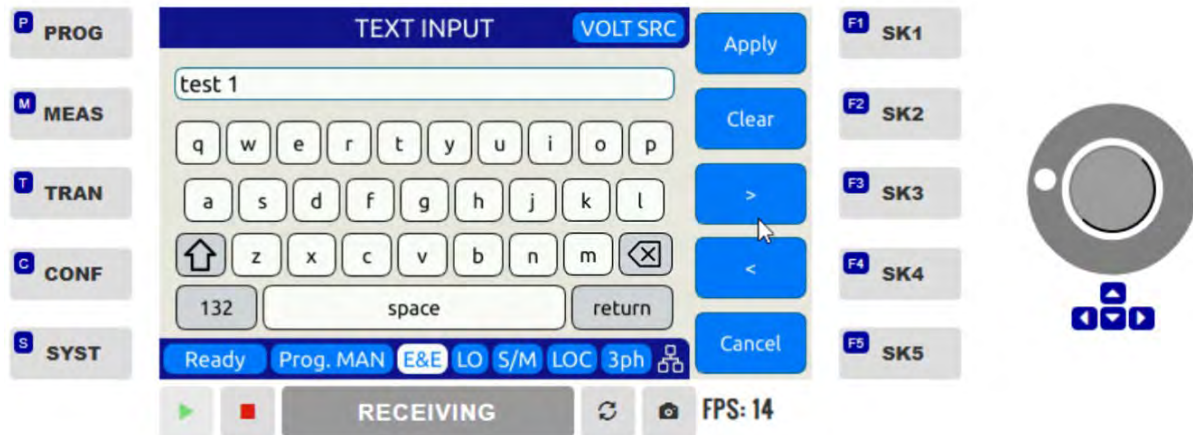

6.8.5.3 LOCAL INTERFACE 2 OF 2

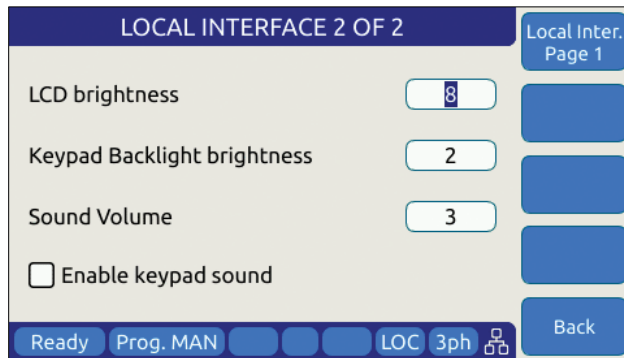

Several aspects of front panel operation can be configured by the user from this screen. These settings relate primarily to visual and audible user interface aspects:

1. LCD brightness
2. Keyboard Backlight
3. Sound Levels

Parameters available to set are as follows:

LCD brightness	Adjusts the LCD display backlight brightness. Range is 0-9.
Keypad Backlight brightness	Adjusts the keyboard backlight brightness. Range is 0-9.
Sound Volume	Adjusts the loudness of the keyboard and message beeps.
Enable keypad sound	Enables or Disables audible beeps when operating the keyboard.

The following soft keys are available from the LOCAL INTERFACE setup screen:

SOFT KEY	Description
Local Inter. Page 1. (SK1)	Toggle to LOCAL INTERFACE 1 OF 2 screen
-	
-	
-	
Back (SK5)	Returns to previous screen

Table 6-35: Available USER INTERFACE screen soft keys

6.8.5.4 LAN (ETHERNET) INTERFACE SETUP Screen

The LAN INTERFACE SETUP screen allows configuring the Ethernet interface for use with your local area network (LAN) and is accessed from the INTERFACE SETUP screen.



WARNING



Do NOT connect the RJ45 LAN (Ethernet) connector of the power source to a PoE (Power over Ethernet) port as the DC voltage will damage the LAN interface.

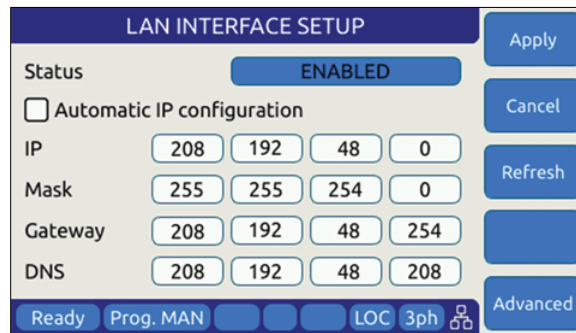

Figure 6-29: ETHERNET INTERFACE SETUP Screen

This screen is used to configure the Ethernet interface for your local area network.

Note: You may need to consult your network administrator to set up this interface correctly.

The following parameters can be set on this screen:

- Automatic IP Configuration** Select this mode if your network has a domain name server running. An IP address will be assigned by the DNS each time the power source is turned on.
- IP** IP address setting. This address must be unique to your network segment. Consult your network administrator if you are not sure about this setting.
- Mask** IP mask setting. This mask must be correct for your network. Consult your network administrator if you are not sure about this setting.
- Gateway** Gateway address setting. Consult your network administrator if you are not sure about this setting.
- DNS** Domain Name Server address setting. Consult your network administrator if you are not sure about this setting.
- Port** Port socket address. For message based instruments like this power source, this setting is typically 5025.

The following soft keys are available from the ETHERNET INTERFACE SETUP screen:

SOFT KEY	Description
Apply (SK1)	Accepts new settings and returns to previous screen.
Cancel (SK2)	Returns to the previous screen.
Refresh (SK3)	
-	
Advanced (SK5)	Access detailed LAN Interface Setting screen

Table 6-36: Available ETHERNET INTERFACE SETUP screen soft keys

6.8.5.5 SERIAL INTERFACE SETUP Screen

The SERIAL INTERFACE SETUP screen allows configuring the RS232 serial interface and is accessed from the “INTERFACE SETUP” screen.

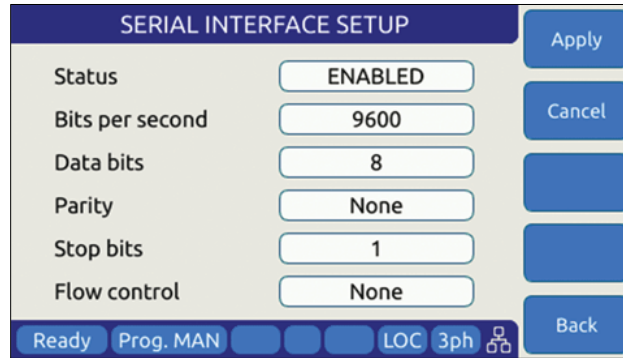

Figure 6-30: SERIAL INTERFCE SETUP Screen

The following parameters can be set on this screen:

- Bits per second** Sets the baud rate. Available settings are 9600, 14400, 19200, 38400, 57600 or 115200.
- Data bits** Sets the number of bits per frame. Available settings are 7 or 8 bits
- Parity** Sets parity check to either odd, even or none.
- Stop bits** Sets the number of stop bits as either 1 or 2.
- Flow control** Sets handshake mode to None or Xon/Xoff

The following soft keys are available from the SERIAL INTERFACE SETUP screen:

SOFT KEY	Description
Apply (SK1)	Accepts new settings and returns to previous screen.
Cancel (SK2)	Returns to the previous screen.
-	
-	
Back (SK5)	Returns to the previous screen.

Table 6-37: Available SERIAL INTERFACE SETUP screen soft keys

6.8.5.6 USB INTERFACE SETUP Screen

The USB INTERFACE SETUP screen allows configuring the USB interface and is accessed from the INTERFACE SETUP screen.

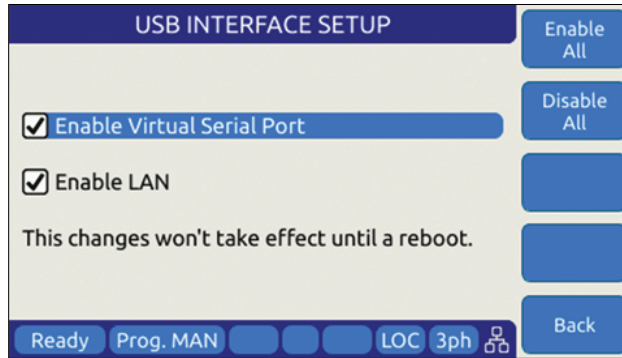

Figure 6-31: USB INTERFACE SETUP Screen

The following settings can be configured on this screen:

- Enable Virtual Serial Port** Enables or disables PC control using a virtual serial port driver.
- Enable LAN** Enables or disables the LAN (Ethernet) Interface IP emulation mode, which supports use of the embedded LXI web server. The virtual IP address of the USB-LAN emulation mode is fixed at 192.168.123.1.

Note: Any changes made to this screen will NOT take effect until the power source has been completely powered off and back on. (Re-boot).

The following soft keys are available from the USB INTERFACE SETUP screen:

SOFT KEY	Description
Enable All (SK1)	Set all check boxes
Disable All (SK2)	Clear all check boxes
-	
-	
Back (SK5)	Returns to the previous screen.

Table 6-38: Available USB INTERFACE SETUP screen soft keys

6.8.5.7 GPIB INTERFACE SETUP Screen

The GPIB INTERFACE SETUP screen allows configuring the GPIB interface and is accessed from the INTERFACE SETUP screen.

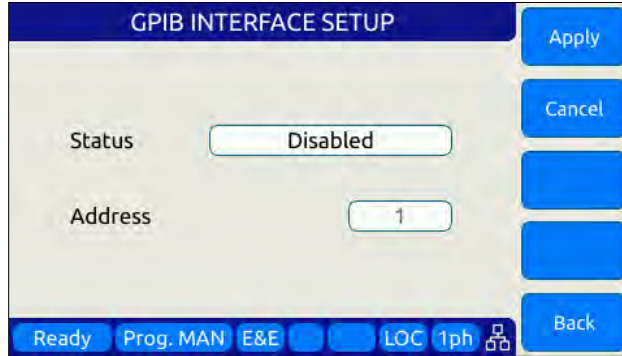

Figure 6-32: USB INTERFACE SETUP Screen

The following settings can be configured on this screen:

- Status** Enables or disables the GPIB interface. Disable when not in use to avoid erroneous interrupts.
- Address** Sets GPIB bus address. Available range is from 1 through 30. Default factory setting is address 1.

The following soft keys are available from the GPIB INTERFACE SETUP screen:

SOFT KEY	Description
Apply (SK1)	Accepts new settings and returns to previous screen.
Cancel (SK2)	Returns to the previous screen.
-	
-	
Back (SK5)	Returns to the previous screen.

Table 6-39: Available GPIB INTERFACE SETUP screen soft keys

6.8.5.8 DIGITAL & ANALOG I/Os SETUP Screen

The Digital & Analog IOs SETUP screen allows configuring the auxiliary I/O interfaces and is accessed from the INTERFACE SETUP screen.

For further details, refer to Section 7.3, “Auxiliary I/O” on page 220.

6.8.5.9 REMOTE INHIBIT SETUP Screen

The REMOTE INHIBIT SETUP screen allows configuring the remote output control input for various modes of operation. Once set, this setting is retained in non-volatile memory so the selection persists between input power cycles.

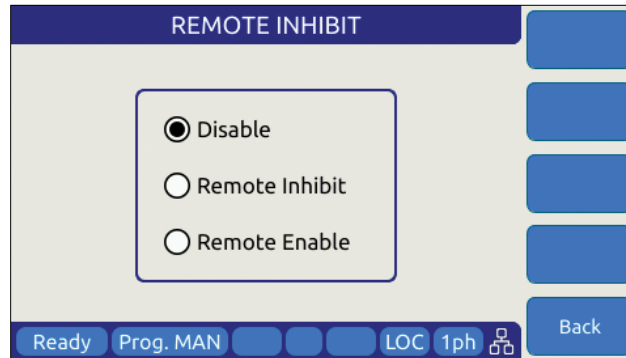

Figure 6-33: REMOTE INHIBIT Setup Screen

There are three modes of operation for this input: remote inhibit and remote enable.

1. **Disable mode:** In his mode, the Remote Inhibit inputs are not active so this function is turned off. No short between the RI pins is required to enable the output in this mode.
2. **Remote Inhibit mode:** The two pins have to be shorted for the output to be enabled from the front panel or remote command. This is a necessary but not a sufficient condition to enable the output. If the output is enabled and the remote inhibit connection is open, a fault is generated. This mode is recommended for interlock safety applications such safety cages and test fixture interlocks.
3. **Remote Enable mode:** The output can be enabled by shorting these two pins, regardless of the output enable command/button. It is a sufficient condition to enable the output.

6.8.5.10 REMOTE SHARING

Remote sharing of the power source is provided using one of two protocols:

Samba: Samba is a free software re-implementation of the SMB networking protocol. Server Message Block (SMB), also known as Common Internet File System (CIFS) operates as an application-layer network protocol for providing shared access to resources miscellaneous communications between nodes on a network.

FTP: File Transfer Protocol. FTP is built on a client-server model architecture using separate control and data connections between the client and the server.

Note: Either one or both may be chosen. It is strongly recommended to set a custom password to prevent unauthorized access to the power source.



6.8.6 UNIT INFORMATION Screen

The UNIT INFORMATION screen is an information only screen that contains information about the power source and is accessed from the SYSTEM SETTINGS screen using the “Unit info” soft key (SK3).

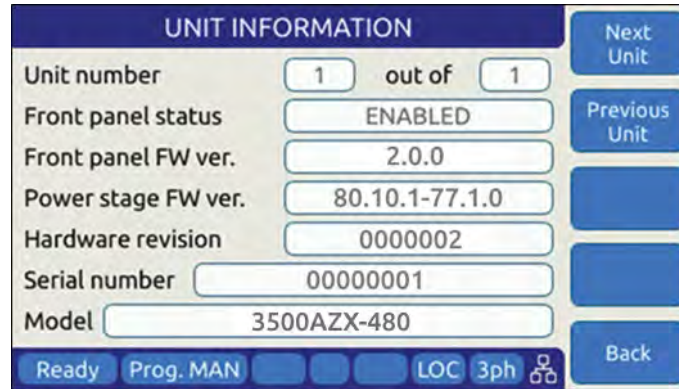

Figure 6-34: UNIT INFORMATION Screen

The following information is provided on this screen:

Unit Number	Shows the position of this unit in a string of paralleled power sources. For a stand-alone power source, the display will show 1 of 1.
Front panel status	Shows the status of the front panel. Only the MASTER unit in a multi-unit system will have its front panel enabled.
Front panel FW ver.	Firmware revision of the front panel control processor.
Power stage FW ver.	Firmware revision of the power stage processors.
Hardware revision	Hardware build revision.
Serial number	Unit Serial number.
Model	Model number, typically 3xxxAZX where xxx = power rating divided by 100.

Note: This information is for information purposes only and cannot be changed by the operator.

The following soft keys are available from the UNIT INFORMATION screen:

SOFT KEY	Description
Next Unit (SK1)	If this unit is part of a parallel system, information on the next unit in the chain will be displayed.
Previous Unit (SK2)	If this unit is part of a parallel system, information on the previous unit in the chain will be displayed.
-	
-	
Back (SK5)	Returns to the previous screen.

Table 6-40: Available UNIT INFORMATION screen soft keys

6.8.7 CONNECTED UNITS Screen

The CONNECTED UNITS screen controls the behavior of this power source in a multi-unit parallel or series system where two or more power sources are either paralleled or in series to provide higher power level systems.

This screen is accessed from the SYSTEM SETTINGS screen using the “Connected Units” entry.



Figure 6-35: PARALLEL UNITS Screen

The first field shows the number of units found at power up on the system bus. A value of 1 means this is a stand-alone unit (not part of a larger system).

The following settings can be configured on this screen:

- Predefine expected units** Tells the power source how many total units to expect to find on the system interface bus at power up. If the number found is less than the number expected as set by the user, one or more units may not be powered up or missing. Leaving this check box off means the system will operate with the number of units found, regardless.
- Stand-alone unit** Set this check box if you want the power supply to operate as a stand-alone unit, even if it is connected to the system interface bus. To do so, you must make sure the outputs of this power source are not connected to any other units’ outputs.
- Expected parallel units** Use this field to enter the number of expected units only if the “Predefine expected units” option is checked.

The following soft keys are available from the PARALLEL UNITS screen:

SOFT KEY	Description
Discover units (SK1)	Re-scan the system interface bus to determine how many units are on the bus. This also happens at power on.
Back (SK5)	Returns to the previous screen.

Table 6-41: Available PARALLEL UNITS screen soft keys

6.8.8 SCPI CONSOLE

The SCIP Console screen allows entry of remote control SPCI command directly from the front panel instead of one of the available remote-control interfaces. This feature is similar to the command line available at the bottom of the Web browser interface Home page.



The following softkeys are available to operate this feature:

Query / Write	Sends the SCPI command shown in the command line on top. The default command is the *IDN? Query which returns the make and mode of the power source. This field will also retain the last command entered by the user.
Clear	Clears the test in the command line and the response area below it.
Scroll Up/Down	Allows scrolling of the text in the response area.
Back	Returns to the System Menu page.

6.8.9 SYSTEM SETTINGS Screen

This screen allows system level settings such date and time to be changed. It also controls the UPC Compatibility mode setting.

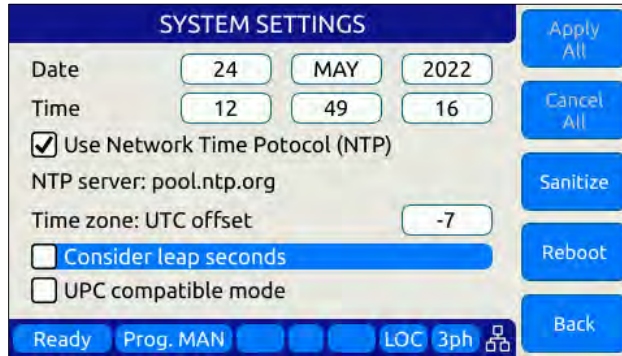

Figure 6-36: SYSTEM SETTINGS Screen

The following parameters can be set from this screen:

Date	Sets the date for the real-time clock.
Time	Sets the time for the real-time clock.
Use Network Time Protocol	When set, the time and date will be adjusted based on the NTP protocol. This requires the power source to be connected to the internet using the Ethernet (LAN) interface. Note that time information may be off slightly due to leap seconds in a given year.
Time zone UTC offset	This parameter sets the number of time zone from UTC where the unit is located to reflect local time. Coordinated Universal Time (UTC) is the primary time standard by which the world regulates clocks and time. It does not observe daylight saving time.
Consider Leap Seconds	When enabled, the time setting incorporated any lead seconds for the current year in the time setting.
UPC compatible mode	When enabled, the controller operates in UPC compatibility mode for back ward compatibility with legacy PPS UPC controllers.

The soft keys on the SYSTEM SETTINGS screen provide access to additional functionality as listed in the table below.

SOFT KEY	Description
Apply All (SK1)	Applies all changes made to this screen.
Cancel All (SK2)	Cancels any changes made and returns to previous screen

SOFT KEY	Description
Sanitize	Erases all user settings from the unit and returns it to its factory default state.
Reboot	Reboot front panel controller without cycling AC input power.
Back (SK5)	Returns to the previous screen.

Table 6-42: Available SYSTEM SETTINGS screen soft keys

6.8.10 MEMORY MANAGEMENT Screen

The AZX Series® is able to use a wide variety of external storage devices such as USB memory sticks and SD-Cards in addition to its internal storage memory. These devices may be used to store or load data, programs (setup + transient) etc.

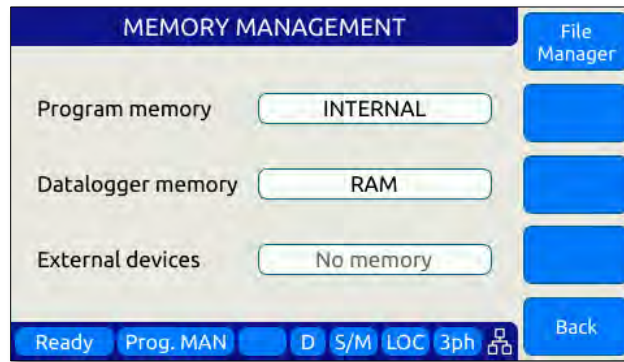

Figure 6-37: MEMORY MANAGEMENT Screen

Program storage memory defaults to INTERNAL but can be changed to any available (inserted and mounted) external memory device if needed. The first parameter field is used to make this selection.

If any external memory devices are inserted, they will appear in the “External memories” field at the bottom of this screen.

Note: Maximum supported external memory device storage size is 32 GBytes.

The following file types can be located in each of these directories.

Subdirectory	File type and naming convention
plot	Measurement plots
sequences	Test sequences
screenshots	PNG image files captured from the LCD screen with filename convention screenshot_YYYY-MM-DD_HH-MM-SS.png where YYYY-MM-DD_HH-MM-SS is the time stamp.
waveforms	CSV comma separated waveform data files with filename convention X.csv where X is a number from 2 through 200.

Subdirectory	File type and naming convention
program	Steady state + transient segment files using filename convention program_xx.xml where xx = 00 through 99 indicated program memory location #.

6.8.10.1 Loading Programs from a USB Drive.

Programs stored on a USB drive using the directory structure shown in the previous section can be loaded using the Browser interface – see section 10.7.4 on page **Error! Bookmark not defined.** – or from the front panel.

To load from the front panel USB ports, store the program_xx.xml file in the program subdirectory and insert in one of the two USB A ports on the front panel. After a short period of time, the drive will mount and will be visible in the CONF -> PROGRAM BROWSER screen.



Select the USBA1 drive in the upper right corner Memory field to see the available program files on the USB drive. Scroll down with the shuttle to select the desired program file to load.

Then use the **Recall** Softkey to load the selected program file. The program will now be available in the assigned program memory location as determined by the XML file name.



Note: program_xx.xml files must have a Steady State section to be valid. The Transient section may be empty in which case no transient will be loaded.

6.8.10.2 File Manger Operation

To access the File Manager functions, Press “**SYST**” -> **Memory management** –(Sk1) **File Manager**”. The File Manager allows the user to browse through the directories and files stored on the selected memory type, INTERNAL, RAM or External media. Select the relevant memory type before entering this screen. See sample screens below.

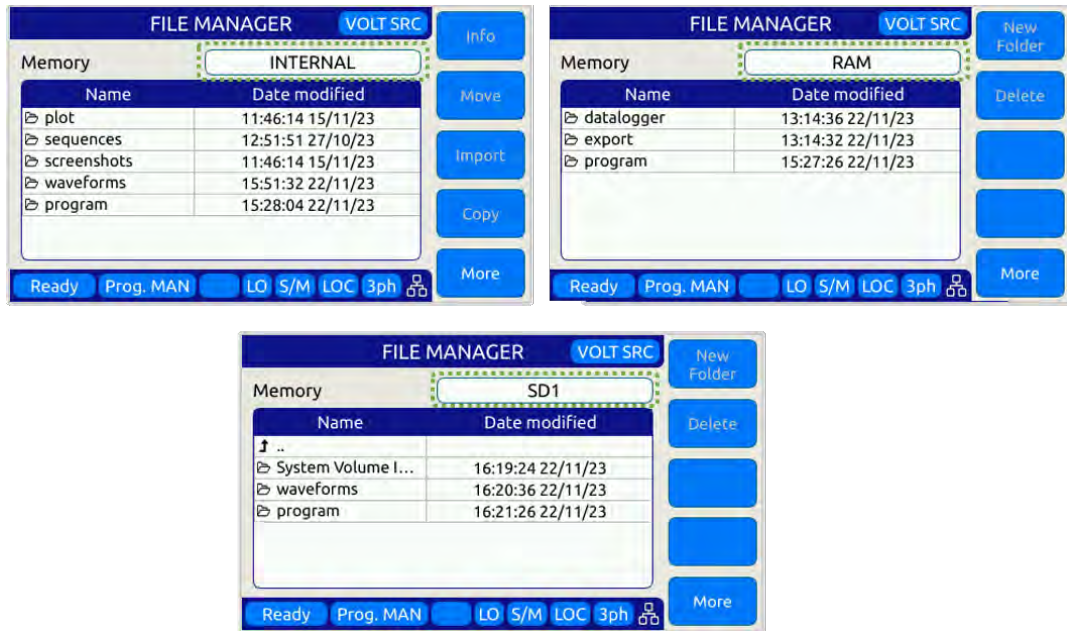

This screen contains file info such as date/time, and supports the following functions:

1. Move, Copy and Delete files.
2. Create new folders.
3. Import Waveforms.
4. Import Programs.

To navigate between files and folders, use the shuttle knob to select a folder and press to enter.

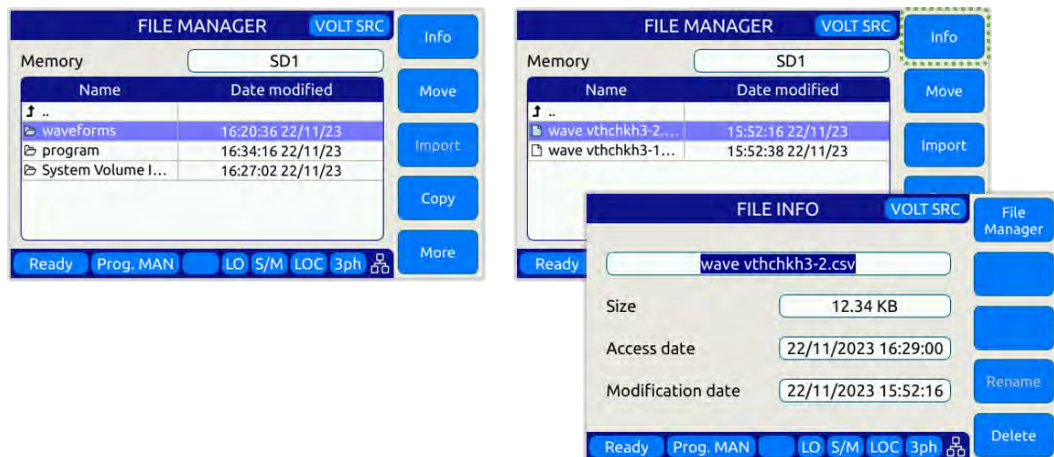

Importing Waveforms

The Import softkey allows importing of CSV format waveforms. Select the location to import the content of the waveform from. Use the +/- softkeys or the shuttle knob to scroll the waveform number. Press the Import (Sk1) softkey and YES to confirm when prompted.

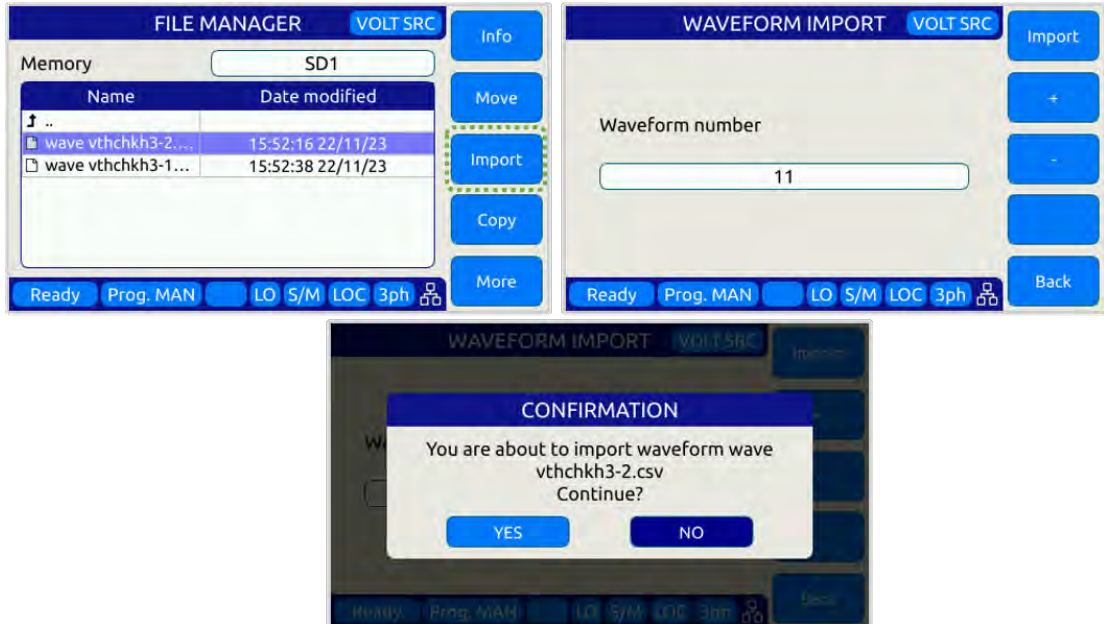

Importing Programs

Importing xml format program files uses a similar process except they are stored in a register location by number. Select the desired program file, select the memory type and register number and press Import (Sk1), the confirm when prompted.

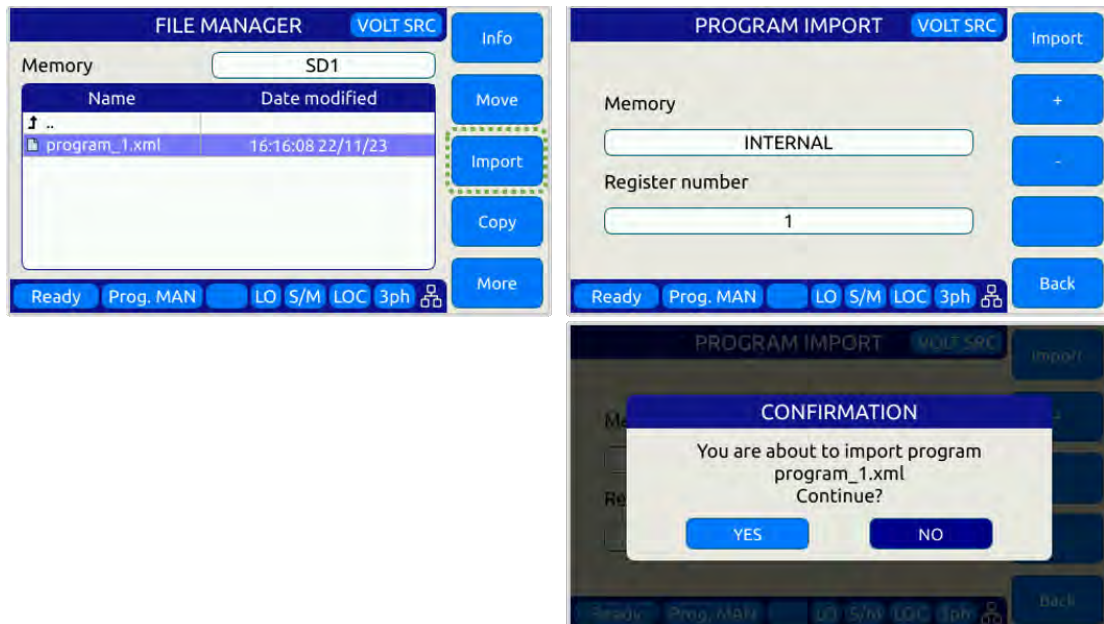

Moving Files

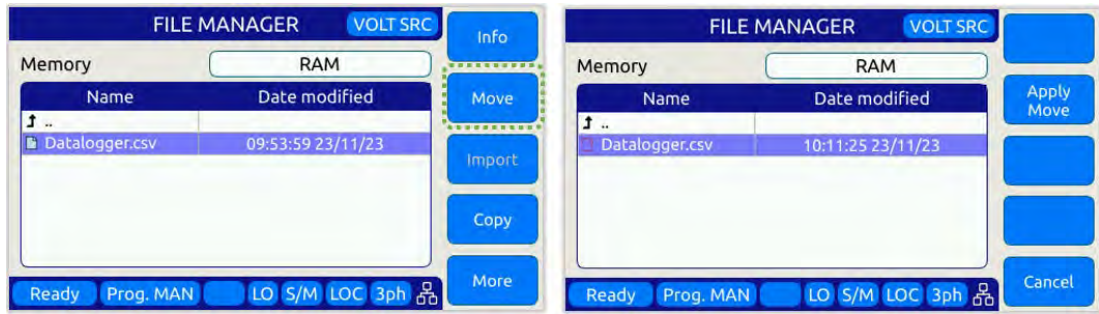

- Changes the directory and then press **“Apply Move”**



Copy and Pasting Files

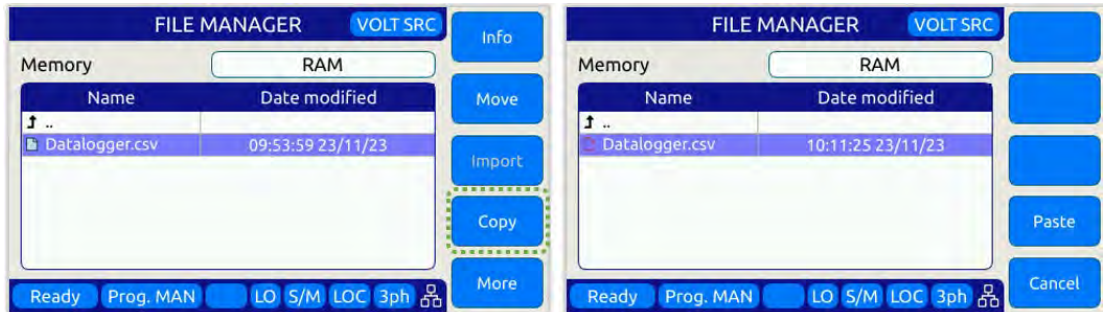

Changes the directory (and/or Memory) and then press **“Paste”**

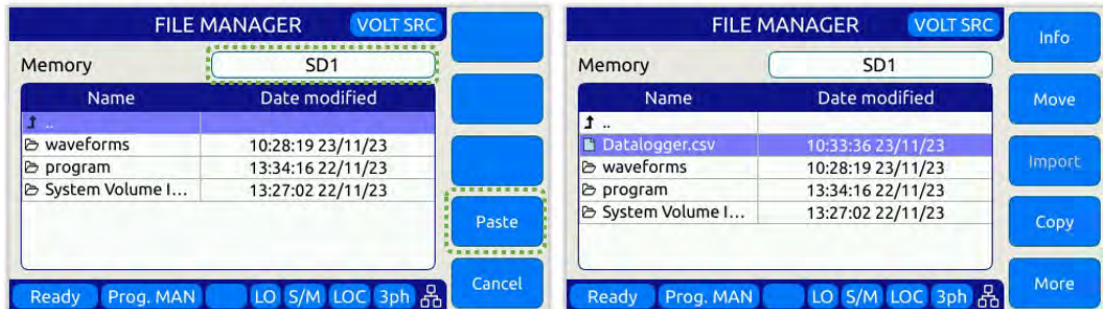

Deleting Files

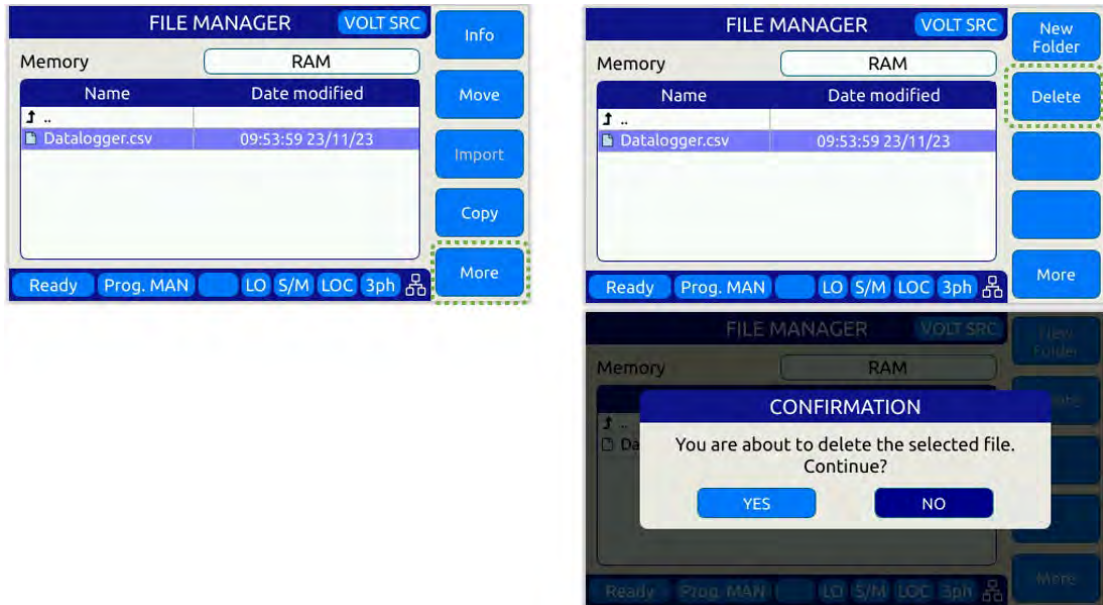

6.8.11 CALIBRATION MENU Screen

All power sources are shipped with a Certificate of Compliance to NIST traceable standards (“CoC”) from the factory. Output and Measurements are calibrated to an external reference DMM at the same time. A suitable current shunt or current transformer and a load will be required to perform calibration.

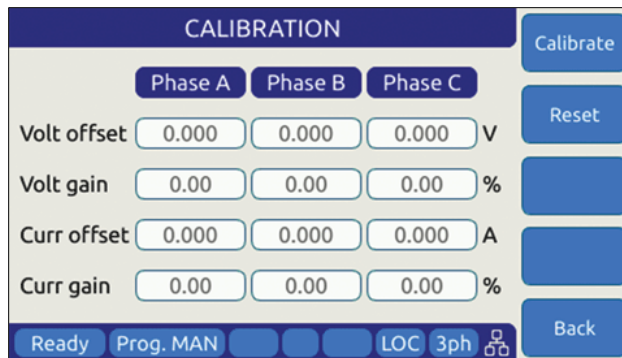

Figure 6-38: CALIBRATION MENU Screen

The following soft keys are available from the CALIBRATION MENU:

SOFT KEY	Description
Calibrate (SK1)	Enters calibration state
Reset (SK2)	Resets all calibration coefficients' previous values.
-	
-	

SOFT KEY	Description
Back (SK5)	Returns to previous screen

Table 6-43: Available CALIBRATION MENU screen soft keys

For details on calibration requirements and procedures, refer to the Calibration section towards the end of this manual. (Section 11, “Calibration”).

6.8.12 FIRMWARE UPDATE Screen

Firmware updates may be distributed via different media such as SD-Card, USB memory stick or on-line through Pacific’s FTP site. The FIRMWARE UPDATE screen provides the means for the end user to perform a firmware update.

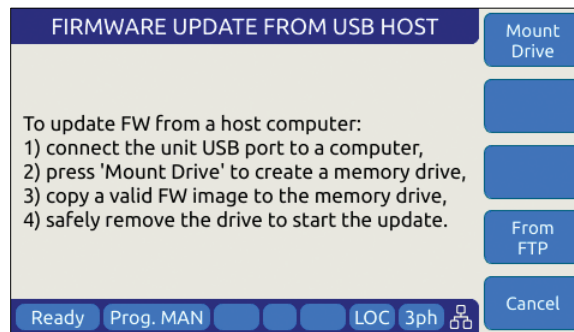

Figure 6-39: FIRMWARE UPDATE Screen

The following soft keys are available from the FIRMWARE UPDATE screen:

SOFT KEY	Description
Mount Drive (SK1)	Mount media that contains new firmware revision.
-	-
From FTP (SK4)	Install latest firmware from Pacific Power Sources’ FTP server.
Cancel (SK5)	Exit firmware update screen

Table 6-44: Available FIRMWARE UPDATE screen soft keys

6.8.13 REMOTE SUPPORT Screen

The REMOTE SUPPORT feature can be used to send information to customer support in case the user experiences an issue with the unit. It also provides a means to allow Pacific’s technical support team to access the unit remotely assuming it is connected to a network with Internet access.

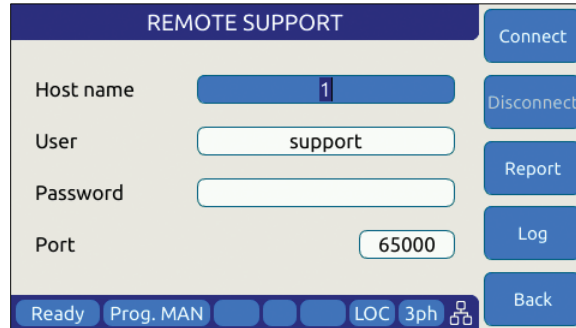

Figure 6-40: REMOTE SUPPORT Screen

The Report soft keys will cause a detailed report to be generated and sent to Pacific Power Source customer support so we can assist in resolving any technical support issues.

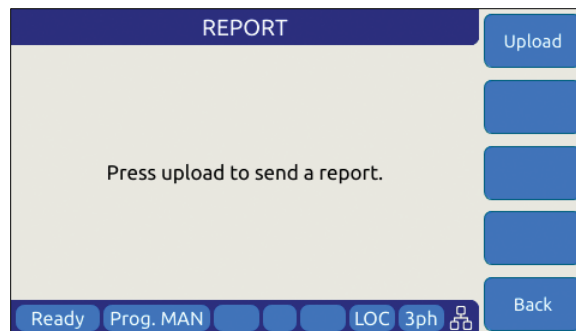

Figure 6-41: Remote Support REPORT Screen

The following soft keys are available from the LOGGING TOOL screen:

SOFT KEY	Description
Connect (SK1)	Connect to Pacific Power Support site
Disconnect (SK2)	Disconnect from Pacific Power Support site
Report (SK3)	Generates a report for Customer Support Department
Log (SK4)	Start Logging
Back (SK5)	Returns to the previous screen.

Table 6-45: Available LOGGING TOOL screen soft keys

7 Rear Panel, Connectors and Protection

This section describes the rear panel layout of the AZX Series® AC power source.

7.1 OUTPUT Terminals



WARNING

HAZARDOUS OUTPUT: The power source output may be set to hazardous voltage levels. It provides basic isolation from the AC input mains. Therefore, the output must always be considered hazardous. Connections must be inaccessible to the operator in all situations when AC input mains voltage is applied.

Always disconnect power supply from the mains before connecting or disconnecting to the hazardous output terminals.



AVERTISSEMENT

SORTIE DANGEREUSE: La sortie de l'appareil peut être réglée à des niveaux de tension dangereux. L'appareil fournit une isolation de base du réseau d'entrée AC. Par conséquent, la sortie doit toujours être considérée comme dangereuse. Les connexions doivent être inaccessibles à l'opérateur dans toutes les situations où la tension d'entrée secteur est appliquée.

Toujours débrancher l'alimentation secteur avant de connecter ou déconnecter les bornes de sortie dangereuses.

The output terminal block for load connections is located near the center of the rear panel.

Note: Always refer to Section 2.3 “Safety Information” and Section 5.13, “Load Connections” on page 82.

7.1.1 Output Power Connector Rating and Isolation

Maximum rated output voltage:	360Vac rms, 510Vdc
Maximum Current Rating:	130A / Phase
Connector Type:	Phoenix Contact
Designated Use:	AC or DC Load Connection
Isolation Rating:	600Vac
Wire Stripping Length:	18 mm

7.1.2 Wire Size

A major consideration in making load connections is the wire size. The minimum wire size is required to prevent overheating and to maintain good regulation. It is recommended that the wires are sized large enough to limit the voltage drop at the maximum current rating of the AC power source to less than 0.5V per lead.

Wire size also depends on ambient temperature and total wires in the cable bundle. For example, for the full 130 amp AC current capability of each phase output, at an ambient temperature of 30 °C, in a bundle of not more than three 75 °C rated wires, common electrical codes would recommend AWG 4 size (~22 mm²) copper wire.

7.1.3 Connecting a UUT

When setting up for a new test and connecting any equipment to the AC power source, proceed as follows:

1. Always make sure the AC power source is turned OFF at the POWER switch when making any wire connections.
2. Check that the output of the equipment under test is **OFF**.
Note: Some power equipment's output may still be energized even if the equipment has been turned off or its output is turned off. This is especially true for AC power sources.

Note: When working with batteries, it is recommended to provide a suitable disconnect relay or switch so the AC power source can be physically disconnected from the battery for handling purposes.

3. Connect one end of the load wires to the output terminals on the rear panel.
4. Check the polarity of the connections and connect the other end of the load wires to the input terminals of the equipment under test.

7.2 External Voltage Sense Input Terminals



WARNING

HAZARDOUS OUTPUT: The power source output may be set to hazardous voltage levels. It provides basic isolation from the ac input mains. Therefore, the external voltage sense must also always be considered hazardous. Connections must be inaccessible to operator in all situations when ac input mains voltage is applied.

Always disconnect power supply from the mains before connecting or disconnecting to the hazardous external voltage sense terminals.



AVERTISSEMENT

SORTIE DANGEREUSE: La sortie de l'appareil peut être réglée à des niveaux de tension dangereux. L'appareil fournit une isolation de base du réseau d'entrée AC. Par conséquent, la sortie doit toujours être considérée comme dangereuse. Les connexions doivent être inaccessibles à l'opérateur dans toutes les situations où la tension d'entrée secteur est appliquée.

Toujours débrancher l'alimentation secteur avant de connecter ou déconnecter les bornes de sortie dangereuses.

This section covers external voltage sensing. This feature improves voltage accuracy at the point of load when used correctly.

Note: External Voltage sense is sometimes referred to as Remote Voltage sense and Internal Voltage sense is sometimes referred to as Local Voltage sense. Both definitions are used in the industry. For consistency, External Voltage Sense and Internal Voltage Sense are used in this manual.

7.2.1 External Voltage Sense Connector Rating and Isolation

Maximum rated voltage:	360Vac rms, 510Vdc
Maximum Current Rating:	1A
Connector Type:	Phoenix Contact
Designated Use:	Voltage Sense Connection
Isolation Rating:	600V
Wire Stripping Length:	10 mm

7.2.2 Load Connection without External Voltage Sense

AZX Series® power sources can be operated with internal voltage sense. For higher current loads, the voltage at the load will drop due to the load cable impedance. Using the proper wire gauge for the rated current of the AC source is required to minimize load cable impedance.

7.2.3 Load Connection with External Voltage Sense.

The following points must be considered, when existing sense cables are connected directly to the load or to the central load distribution point:

1. Minimize the distance between the AC power source and the load as much as possible to keep load wire length to a minimum.
2. Directly connect **A, B, C** with **correct phasing** to the load distribution point
3. Avoid overload of power wires

Note: External voltage sense connections are at the programmed output voltage when the output is on so DO NOT connect or disconnect the external voltage sense lines while the AC power source is in use.

7.3 Auxiliary I/O

The Auxiliary I/O functions are available on all AZX Series power source models.

7.3.1 Auxiliary I/O Functions

The Auxiliary I/O board when added to an AZX Series power source adds the following functions and features:

- Digital Inputs for trigger functions and control.
- Digital Outputs for status indication and relay control.
- Analog Inputs for control of power source parameters.
- Analog Outputs for measurement monitoring.
- A 12Vdc power output to power external circuits.
- RS232 Serial Interface.
- Optional embedded GPIB Control Interface

The analog, digital and RS232 ports are accessible on a female DB25 connector located on the rear panel of the AZX master unit. This connector is mounted upside down so pin 1 is located in the lower right-hand corner when facing the back of the AZX master unit.

The USB, LAN and optional GPIB connectors are located to the left of the AUX I/O connector on the rear panel when facing the power source from behind.



7.3.2 DB25 Connector AUX I/O Pin Locations

The pin locations for the various I/O signals on the DB25 connectors are shown in Figure 7-2 below. For AZX models with the “H” Option installed, see page 224.

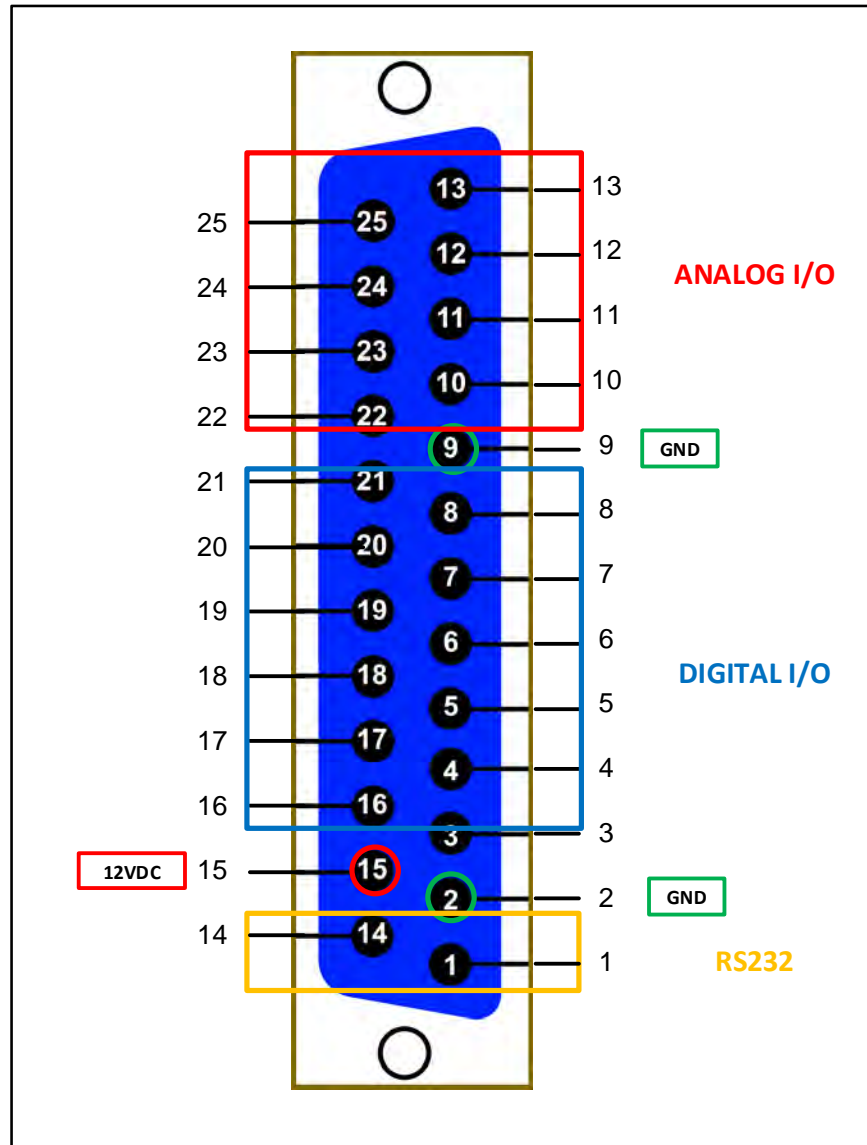

Figure 7-1: DB25 Connector AUX I/O Pin Locations

Functional grouping of pins by I/O function is done as shown in the figure above. The left hand side groups all **Analog I/O** signals on top on bottom row. The middle section is reserved for all **Digital I/O** pins. The **RS232** Transmit (Tx) and Receive (Rx) signals are located on the far left when facing the back of the unit.

7.3.3 Aux I/O Signal Table by pin number

Pin assignments in order of pin number are shown in the table below.

Pin #	Name	Primary Function	Alternate Use / Comment	Type	Direction
1	RxD	RS232 Receive Data (Rx)		RS232	Input
2	GND	Chassis Ground		Ground	n/a
3	DI1	General Purpose Digital Input #1	Programmable	Digital	Input
4	DI2	General Purpose Digital Input #2	Programmable	Digital	Input
5	DI3	General Purpose Digital Input #3	Programmable	Digital	Input
6	RI	Remote Inhibit	Short to +12Vdc Pin 15 to enable output	Digital	Input
7	TT	Transient Trigger Input		Digital	Input
8	Sync In	Phase Sync Input		Digital	Input
9	GND	Chassis Ground		Ground	n/a
10	AI1	Analog Input – Volt RMS Phase A	Any set point	Analog	Input
11	AI2	Analog Input – Volt RMS Phase B	Any set point	Analog	Input
12	AI3	Analog Input – Volt RMS Phase C	Any set point	Analog	Input
13	AI4	Analog Input – Current Limit RMS all phases	Any set point	Analog	Input
14	TxD	RS232 Transmit Data (Tx)		RS232	Output
15	12V	Output, 12Vdc	0.5 A max, current protected	Power	Output
16	DO3 /RC1	Relay Control #1 – FORM	Programmable, Open Collector, Current protected	Digital	Output
17	DO4 /RC2	Relay Control #2 - TRANSFORMER	Programmable, Open Collector, Current protected	Digital	Output
18	FS	Trigger Output / Function Strobe		Digital	Output
19	Sync Out	Phase Sync Output		Digital	Output
20	DO1	General Purpose Digital Output #1	Programmable	Digital	Output
21	DO2	General Purpose Digital Output #2	Programmable	Digital	Output
22	AO1	Analog output #1 – Volt RMS Measurements Phase A	Any other measurement	Analog	Output
23	AO2	Analog output #2 – Volt RMS Measurements Phase B	Any other measurement	Analog	Output
24	AO3	Analog output #3 – Volt RMS Measurements Phase C	Any other measurement	Analog	Output
25	AO4	Analog output #4 – Total Power (all phases combined)	Any other measurement	Analog	Output

Table 7-1: Auxiliary I/O DB25 Connector Pin numbers and Signals by DB25 pin number

7.3.4 Aux I/O Signal Table by Function

Pin assignments in order of pin number are shown in the table below.

Pin #	Name	Primary Function	Alternate Use / Comment	Type	Direction
10	AI1	Analog Input – Volt RMS Phase A	Any set point	Analog	Input
11	AI2	Analog Input – Volt RMS Phase B	Any set point	Analog	Input
12	AI3	Analog Input – Volt RMS Phase C	Any set point	Analog	Input
13	AI4	Analog Input – Current Limit RMS all phases	Any set point	Analog	Input
22	AO1	Analog output #1 – Volt RMS Measurements Phase A	Any other measurement	Analog	Output
23	AO2	Analog output #2 – Volt RMS Measurements Phase B	Any other measurement	Analog	Output
24	AO3	Analog output #3 – Volt RMS Measurements Phase C	Any other measurement	Analog	Output
25	AO4	Analog output #4 – Total Power (all phases combined)	Any other measurement	Analog	Output
3	DI1	General Purpose Digital Input #1	Programmable	Digital	Input
4	DI2	General Purpose Digital Input #2	Programmable	Digital	Input
5	DI3	General Purpose Digital Input #3	Programmable	Digital	Input
20	DO1	General Purpose Digital Output #1	Programmable	Digital	Output
21	DO2	General Purpose Digital Output #2	Programmable	Digital	Output
18	FS	Trigger Output / Function Strobe		Digital	Output
16	DO3 /RC1	Relay Control #1 – FORM	Programmable, Open Collector, Current protected	Digital	Output
17	DO4 /RC2	Relay Control #2 - TRANSFORMER	Programmable, Open Collector, Current protected	Digital	Output
6	RI	Remote Inhibit	Short to +12Vdc Pin 15 to enable output	Digital	Input
8	Sync In	Phase Sync Input		Digital	Input
19	Sync Out	Phase Sync Output		Digital	Output
7	TT	Transient Trigger Input		Digital	Input
15	12V	Output, 12Vdc	0.5 A max, current protected	Power	Output
2	GND	Chassis Ground		Ground	n/a
9	GND	Chassis Ground		Ground	n/a
1	RxD	RS232 Receive Data (Rx)		RS232	Input
14	TxD	RS232 Transmit Data (Tx)		RS232	Output

Table 7-2: Auxiliary I/O DB25 Connector Pin numbers and Signals by Signal Name

7.3.5 DB25 Connector REAL TIME I/O Pin Locations – Option “H”

The pin locations for the various I/O signals on the DB25 connectors are shown in Figure 7-2 below.

Note: When HIL is used, the standard AUX IO digital output # 2 (DB25 pin16) reflects the single-ended or differential signal configuration setting of the analog signals.

Note: To use analog inputs in single-ended mode, connect Neutral terminals (N) to Ground (GND).

Pin #	Name	Primary Function	Type	Direction
1	V_SNS_ISO_A_P	V_SNS_ISO_x_P/N: output voltage signals that mirror the unit output voltage, one per phase.	Diff or SE Analog	Output
14	V_SNS_ISO_A_N			
2	V_SNS_ISO_B_P			
15	V_SNS_ISO_B_N			
3	V_SNS_ISO_C_P			
16	V_SNS_ISO_C_N			
4	GND		GND	
8	GND			
5	I_SNS_ISO_A_P	I_SNS_ISO_x_P/N: output voltage signals that mirror the unit output current, one per phase.	Diff or SE Analog	Output
18	I_SNS_ISO_A_N			
6	I_SNS_ISO_B_P			
19	I_SNS_ISO_B_N			
7	I_SNS_ISO_C_P			
20	I_SNS_ISO_C_N			
17	GND		GND	
21	GND			
9	ANALOG_IN_A_P	ANALOG_IN_x_P/N: input voltage signals to program unit output current or voltage.	Diff	Input
22	ANALOG_IN_A_N			
10	ANALOG_IN_B_P			
23	ANALOG_IN_B_N			
11	ANALOG_IN_C_P			
24	ANALOG_IN_C_N			
12	DIGITAL_OUT	Connected internally to AUX IO digital output # 1 (DB25 pin14), can be configured for multiple purposes (see section 7.3.2 on page 221 of this manual).	Digital	Output
25	DIGITAL_IN	Connected internally to AUX IO digital input # 2 (DB25 pin7), can be configured for multiple purposes (see section 7.3.2 on page 221 of this manual).	Digital	Input
13	FAULT_IN	Connected internally to AUX IO digital input # 1 (DB25 pin5), can be configured to generate an immediate shut down in the unit output (see section 7.3.2 on page 221 of this manual).	Digital	Input

Figure 7-2: DB25 Connector REAL TIME I/O with H option Pin Locations

7.3.6 Dedicated Function Digital Inputs

- Remote Inhibit
- External Trigger Input
- External Phase Sync Input

7.3.6.1 Remote Inhibit

The mode can be selected from the SYST (SYSTEM) menu screen using the Interfaces, Remote Inhibit selection as shown below.

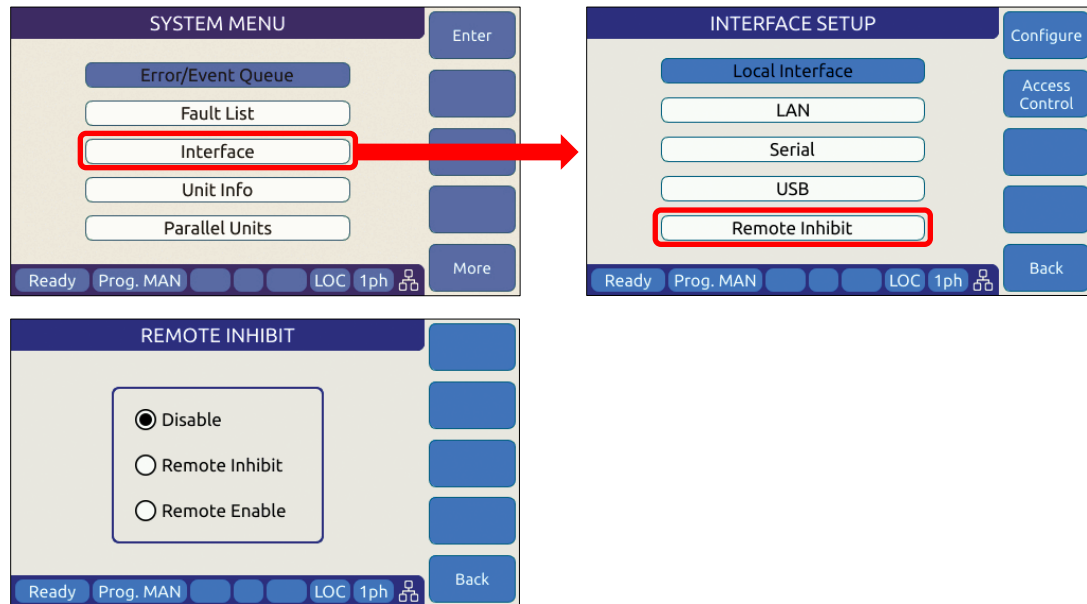

There are three modes of operation for this input:

1. **Disable mode:** In this mode, the Remote Inhibit inputs are not active so this function is turned off. No short between the RI pins is required to enable the output in this mode.
2. **Remote Inhibit mode:** The two pins have to be shorted for the output to be enabled from the front panel or remote command. This is a necessary but not a sufficient condition to enable the output. If the output is enabled and the remote inhibit connection is open, a fault is generated. This mode is recommended for interlock safety applications such as safety cages and test fixture interlocks.

Command: SYSTem:DIO:REMOte:INHibit 0 | 1

3. **Remote Enable mode:** The output can be enabled by shorting these two pins, regardless of the output enable command/button. It is a sufficient condition to enable the output.

Command: SYSTem:DIO:REMOte:ENABle 0 | 1

7.3.7 Transient Trigger Input

The external trigger input can be programmed to trigger the start of a transient program. This allows the power source output sequence to be initialized by an external sync signal.

In order to use the trigger input, the mode has to be active (from any of the graphical interfaces or using the SCPI command `PROG:TRANS:TRIG:IN`), and the transient program has to be executed first. The transient will wait and start execution when a rising edge is detected on this digital input.

The graphical interfaces (front panel and webpage) will show the state “Running” but with a progress of 0% until the transient program is actually started.

The following specifications apply to the external trigger input:

Input Voltage	Logic Low $V_{in} < 0.4\text{ V}$ Logic High $V_{in} > 2.0\text{ V}$
Impedance	10 k Ω
Edge Triggered	Rising edge

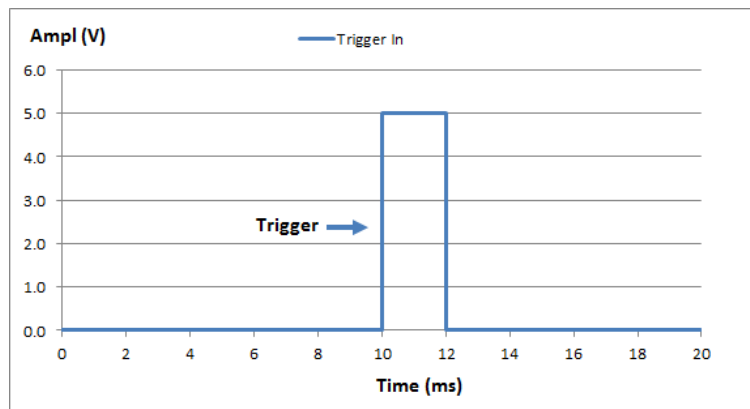

Figure 7-3: External Trigger Input Timing

7.3.8 External or Line Sync Input

The phase sync input can be used to synchronize in frequency and phase the internal waveform generation of the AZX to an external sync reference or to the AC mains. The reference must be within the specified frequency range of the power source and zero phase offset calibration for phase A may be required to compensate for any phase shifts. Note that Phase B and C are still phase related to A as programmed by B and C phase angles.

7.3.8.1 Principle of Operation

In AC Line sync mode, the AZX uses the L-L AC input voltage to generate the internal sync signal. The goal of the phase sync is to provide precise frequency synchronization, and consistent phase at a given operating point, but the phase shift between AC input and AC output is not automatically zero. A phase adjustment for Phase A must be made by the user to time-align the power source’s phase A output voltage to the L1 leg of the actual three phase Grid voltage powering the AZX.

A couple of factors affect the phase shift:

- The internal AC sync circuits have some inherent delays. If more accuracy is required then the TTL input mode can be used instead using an external line sync circuit.
- Even if TTL input is used, there can be a phase shift that depends on the output load because of the finite bandwidth of the output inverter stages. This is particularly visible at higher frequencies. At 50Hz or 60Hz, the phase shift will be pretty small.

Note: When the sync input is enabled, the AZX frequency set point **must** be set to a value similar to the external sync signal. This minimizes the synchronization time and improves the stability of the generated frequency.

After the sync input is activated, or the external signal frequency/phase is changed, the Sync circuit's Phase Lock Loop (PLL) requires a short time to "lock" to the external source. The AZX reports the status of the PLL in the external interfaces (front panel and webpage) by showing a "**Synced**" or "**Unsynced**" message in the status bars.

The status can also be queried with the SCPI command "SOURce:SYNChronize:STATE?".

The sync circuit is able to synchronize to any signal with a frequency if $F_{\text{SETPOINT}} \pm F_{\text{RANGE}}$, where F_{SETPOINT} is the normal frequency set point and F_{RANGE} is a configurable value (default is 10Hz)

The following specifications apply to the phase sync input at the DB25 port:

Input Voltage	Logic Low $V_{in} < 0.4 \text{ V}$ Logic High $V_{in} > 2.0 \text{ V}$
Impedance	10 k Ω
Frequency Range	15 Hz – 1000 Hz
Edge Triggered	Rising edge

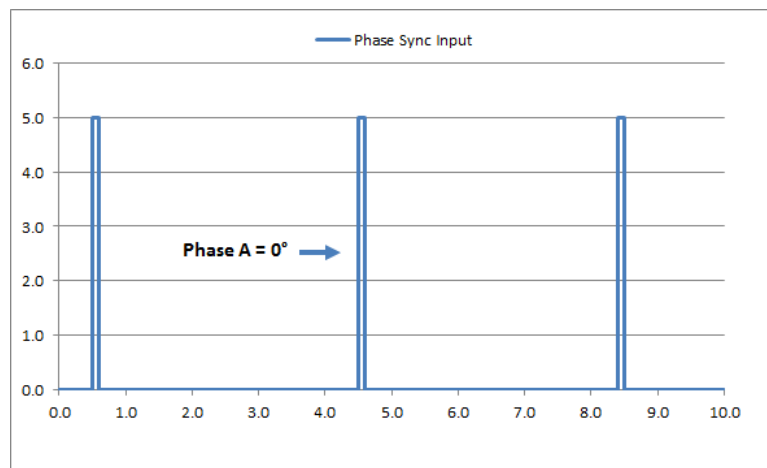

Figure 7-4: External Sync Input Pulses

7.3.8.2 SYNC Status Display

A “Synced” status field will be displayed in **Green** in the lower left corner of the LCD display. This field will toggle with the regular “Ready/Enabled/Fault” status field also shown in this location. The “Synced” status will be shown every 3 seconds for 1 second in place of the “Ready/Enabled/Fault” field. When the PLL is not locked to the external source, the unit will display an “Unsynced” status in **Orange**.

It is not recommended to enable the unit when it has not locked or synchronized to the external source because the frequency may be unknown.

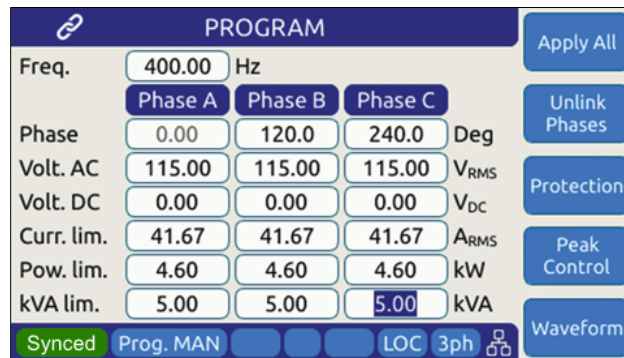

Figure 7-5: External Sync Input Sync Status Indication

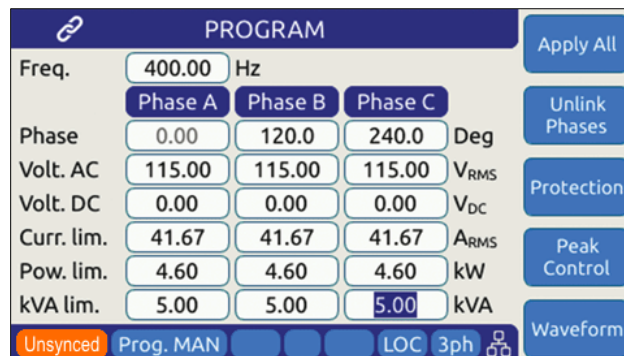

Figure 7-6: External Sync Input Sync Lost Status Indication

7.3.8.3 Sync Operation Settings

The AZX allows precise configuration of the synchronization parameters to optimize performance for each application. The parameters are:

- 1 **Phase shift:** Defines a fixed phase shift between phase A waveform generation and the external sync source. Used to calibrate any phase difference between the sync signal and the power source output on phase A.
Command: SOURce:SYNChronize:PHASEshift
- 2 **Speed:** Allows accelerating the speed of the internal synchronization engine (PLL) in case the external sync source is not constant and presents periodic or continuous

changes. A slower speed improves the stability of the waveform frequency, so it is recommended to use the smallest possible speed values.

Command: SOURce:SYNChronize:SPEed

- 3 **Range:** Allows configuration of how much the synchronization engine is able to deviate from the AZX programmed frequency. This helps to keep the waveform frequency under control, even if the external source is not present all the time. The synchronization engine is limited to frequencies of FSETPOINT +/- FRANGE.

Command: SOURce:SYNChronize:RANGe

7.3.9 Digital Output control signals

- External Relay Control #1 - FORM
- External Relay Control #2 - TRANSFORMER
- Trigger Output / Function Strobe
- Phase Sync Output

7.3.9.1 Function Strobe / Trigger Out

The external trigger output can be programmed to generate an output pulse on the following events:

- a. The start of a transient program (Transient Trigger)
- b. Output Replay State Change
- c. Any parameter change. Parameter changes that generate an output function strobe pulse are:
 - i. Voltage on any phase
 - ii. Frequency
 - iii. Waveform on any phase
 - iv. Phase angle

The mode can be set from the front panel or by using the following SCPI commands:

Transient start mode:	SYSTem:DIO:STROBE:TRANSient 0/1	
	PROGram:TRANSient:TRIGger:OUTput 0/1	(alias)
Output Relay mode:	SYSTem:DIO:STROBE:OUTPutstate 0/1	
Program Change mode:	SYSTem:DIO:STROBE:SOURce 0/1	

The following specifications apply to the external trigger output:

Output Voltage @ 0.4 mA	Logic Low Vout < 0.4 V
	Log High Vout > 4.6 V
Max. Current	± 10 mA

Output Impedance	100 Ω	
Pulse Width	190 us ± 10 us	For Transient Trigger mode
	2.0 msec ± 10 μs	For OUTPutstate & SOURce modes

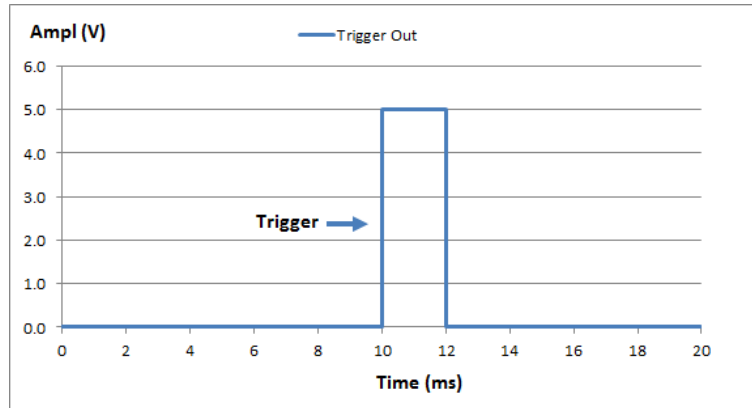

Figure 7-7: Transient Trigger Output Pulse

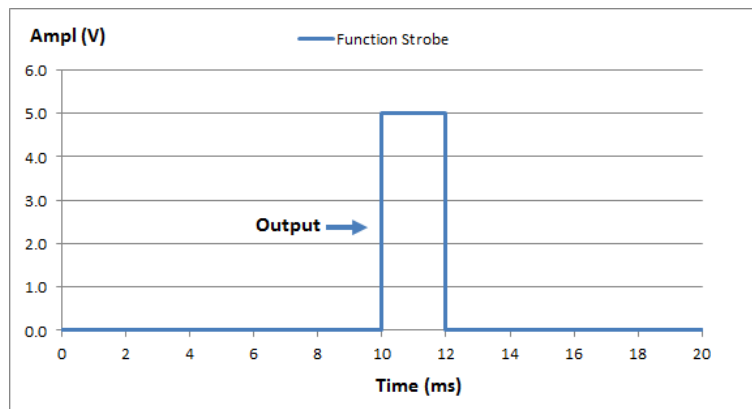

Figure 7-8: Function Strobe Output Pulse

7.3.9.2 Phase Sync Output / External Sync Output

The phase sync output or External Sync Output signal can be programmed to generate an output pulse at each zero crossing of the phase A voltage. This indicates the 0° phase angle output on Phase A.

The mode can be set from the front panel or by using the following SCPI commands:

The following specifications apply to the external trigger output:

Output Voltage @ 0.4 mA	Logic Low Vout < 0.4 V Logic High Vout > 4.6 V
Max. Current	± 10 mA
Output Impedance	100 Ω
Pulse Width	Programmable from 3 μs to 100000 μs (100 msec) Programmable polarity Auto 50% duty cycle mode available

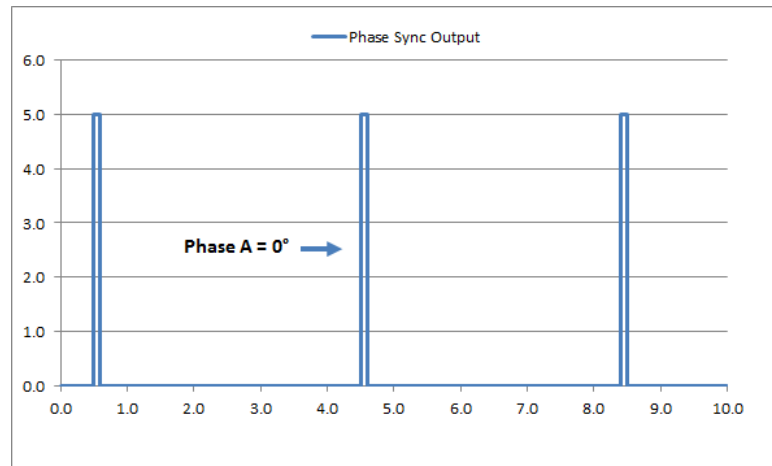

Figure 7-9: Phase A Zero Phase Sync Output Pulse

7.3.10 User Programmable Digital signals

Available user defined digital input and outputs are provided as part of the I/O feature. These signals may be assigned different purposes under software control.

User Programmable Digital Input signals functions are:

- DIO:INput1 - Digital Input #1
- DIO:INput2 - Digital Input #2
- DIO:INput3 - Digital Input #3

User Programmable Digital Output control signals are:

- DIO:OUTput1 - Digital Output – TTL level
- DIO:OUTput2 - Digital Output – TTL level
- DIO:OUTput3 - Digital Output – Open drain
- DIO:OUTput4 - Digital Output – Open drain

Digital outputs 3 and 4 are open drain with internal +5Vdc pull-ups.

7.3.10.1 Relay Control Outputs

The external relay control output signals DO3 and DO4 can be used to control external relays. These control lines are user programmable for difference functions such as FORM relay control and Transformer Option control.

These relays are used to either short all outputs together for single-phase output mode or to connect and disconnect and external transformer for a higher voltage AC output range.

- Relay signal #3 is normally used for the FORM (Mode Change) Relay option on AZX cabinet systems.
- Relay signal #4 is normally used for the Transformer Option.
- A 12V dc output is provided as well to drive a small signal relay to operate a large contactor.

7.3.10.2 Digital User Inputs

The digital inputs allow any action to be executed at the rising and/or falling edge of the signal, by simply assigning a SCPI command for execution to that event.

For example, a digital input can be configured to enable the output at the rising edge and disable it at the falling edge of the signal. Alternatively, it can be configured to change any set point and either of those 2 events.

A total of three digital inputs are available. These following input characteristics can be programmed for each digital input (1, 2 and 3):

- **Command** to execute (a SCPI command string) at each edge. Rising and falling edges can have different commands.

- **Filter** Setting, to reduce sensitivity to short pulses that can be caused by electrical noise or some mechanical switches.

See SCPI command section 8.10.1.3 for commands that configure and read digital inputs.

7.3.10.3 Digital User Outputs

There are four programmable digital outputs (1 to 4), which can be configured to change state based on different conditions:

- 1=ON, 0=OFF it is used as general-purpose digital output, with the value set with a SCPI command.
- OUTPUT_STATE indicates output enabled (1) or disabled (0).
- FORM indicates single (1) or split/three (0).
- FAULT indicates fault (1) or no fault (0).
- TRANSIENT indicates when a transient is running/paused/stepping (1) or stopped (0).
- PROGRAM indicates when a program is in execution at steady state level (1) or manual mode (0).
- REMOTE indicates remote (1) or local (0).
- XFMR_COUPLING indicates direct (0) or transformer (1) coupling. This output is relevant only when an output transformer option is installed and configured.

Note: Each output can be also configured to invert its logic.

User defined digital inputs can be queried using the SYSTEM:DIO:OUTput# command.

Digital outputs 1 and 2 are TTL level signals (0 to 5V), and digital outputs 3 and 4 are open-drain type outputs (with an internal pull-up) that can be used to drive external relays. Each open-drain output has a current protection of 0.5A and internal clamping diode prepared to drive a relay coil.

See section 8.10.1.4 for commands that configure and read digital outputs.

7.3.11 Analog I/O Descriptions

Both analog inputs and outputs are available on the AUX I/O feature. Analog inputs are used to change output parameters such as voltage or frequency. Analog outputs are provided to allow monitoring the AZX measurements using external equipment.

7.3.11.1 Analog Inputs

There are 4 analog inputs that accept DC signals up to 10Vdc and may be used to program the AZX output parameters such as voltage, frequency, current and power limits. Negative voltages of up to -10Vdc can be used to program DC voltage.

These inputs are sampled 20 times per second so updates of the assigned parameters occur at this rate. The full-scale range of the analog inputs can be programmed to be 5V, 10V or any value between 1 and 10V.

Note: Once enabled, make sure the input is not left floating or a small offset of about 2 to 3 % of full scale may be present affecting the programmed parameter. For example, when programmed to control AC voltage, no input on the analog input assigned will result in an output voltage of about 0.02 to $0.03 \times 300 = 6$ to 9 Vac.

The full-scale value for voltage programming depends on the selected operating mode. In AC and AC+DC modes, 10V input represents 440Vac RMS. In DC mode, ± 10 V input represents ± 650 Vdc.

For frequency programming, 0V represents 15Hz while 10V represents 1000Hz.

These analog inputs are all disabled by default. In order to use this feature, each analog input has to be assigned to an AZX parameter and phase, for example AC voltage of phase A.

7.3.11.2 Programming Analog Inputs

The range of the analog inputs can be changed with two parameters for each input, gain and offset. For example if an input is assigned to AC voltage programming the default gain is 440V and the offset is 0V. This means that 10V at the analog input port represents a programmed voltage of 440Vrms and 0V represents 0Vrms.

Different gain and offset combinations can be used to customize the range of the analog programming input, being the “gain” the programmed value that represents the maximum input at the analog port, and “offset” the value at 0V. For example, a gain of 150V and offset of 50V produce an output of 50V to 200V for analog programming signals of 0V to 10V.

Note: Different AZX parameters have different units (Volts, Amperes, Watts, Hertz, etc.), so when an analog input parameter is changed, the gain and offset are reset to default values (zero for offset and max full-scale values for gain).

7.3.11.3 Analog Outputs

Analog outputs are available to monitor output values for voltage, current or power using external measurement equipment. A total of four analog outputs are provided, with an output voltage range of 0 to 5V. Output scaling is fully programmable for each measurement with an offset and gain.

For example, for RMS voltage measurements the default gain is 440V and offset is 0V. This means that measurements of 0 to 440V generate monitoring voltages of 0 to 5V. An offset of 50V and a gain of 150V will mean that measurements in the range of 50 to 200V will be mapped to the analog output range of 0 to 5V.

Analog outputs are available to monitor output values for voltage, current or power using external measurement equipment. A total of four analog outputs are provided. Output scaling is from 0 to 10V for zero to full scale.

Pin #	Signal	Programs
22	AO1	Volt RMS Measurements Phase A
23	AO2	Volt RMS Measurements Phase B
24	AO3	Volt RMS Measurements Phase C
25	AO4	Total Power (all phases combined)

Table 7-3: Default Analog Output Functions

7.3.12 12 DC Power Supply

A pin in the DB25 port provides a current limited, regulated 12V supply. The maximum current capability is 0.5A_{dc}.

There are no menus or commands associated with this output, as it is always active.

7.3.13 RS232 Description

The Tx and Rx signal on the AUX I/O connector may be used to connect to a serial port. Only Xon/Xoff handshake mode is supported on this RS232 port. For most situations, it is recommended to use the USB Device port for remote serial control applications.

7.3.14 Front Panel Operation of AUX I/O Functions

The auxiliary I/O functions can be configured and programmed from the front panel using the SYSTEM menu (Press SYST key to left of the LCD screen). This section describes the available AUX I/O program screens and parameters for each function.

7.3.14.1 Accessing AUX I/O Screens.

From the SYSTEM MENU, scroll to the INTERFACE entry and press the shuttle or ENTER key as indicated below. If the Interface selection is not visible, press the “More” soft key to display the second System Menu screen.

Next, scroll to the “Digital & Analog I/Os” entry at the bottom of the INTERFACE SETUP screen.

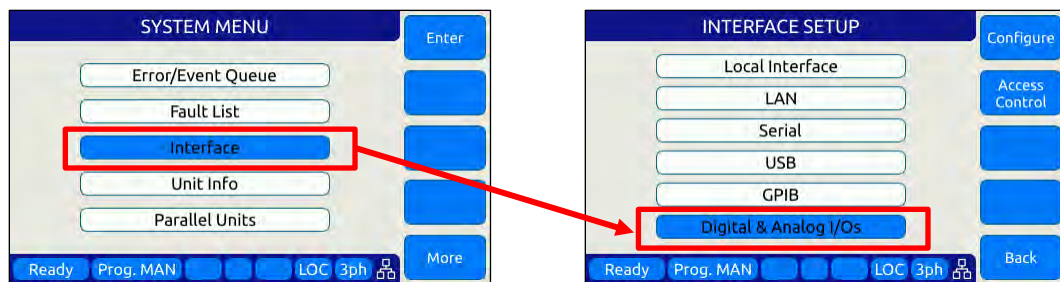

This will display a list of available Auxiliary I/O functions and features. To display the second of two DIGITAL & ANALOG I/Os screens, use the “More” soft key.



To select the desired function, use the knob to scroll up or down. Once selected, press the Shuttle knob or ENTER key to open the relevant I/O control screen.

Each screen is covered in the following sections in more detail.

7.3.14.2 Analog Inputs

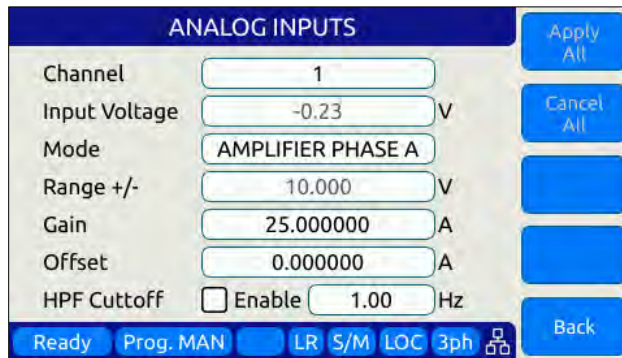

Analog inputs allow parameters settings to be controlled using DC input signals. The parameter to be controlled by each of four available analog inputs can be assigned from the front panel.

Available settings or read-outs and parameter ranges are:

- CHANNEL [1 | 2 | 3 | 4]
- INPUT VOLTAGE Displays read back voltage
- COMMAND Select command from dropdown list or OFF for none. See table below
- RANGE 0.0000 to 10.000 V
- GAIN Gain (Either V or A depending on operating mode)
- OFFSET Offset value (Either V or A depending on operating mode)
- HPF CUTOFF High Power Frequency Cutoff Enable/Disable

The **Command** parameter allows the user to assign the selected analog input to the parameter that will be controlled by it. The list of available setting commands for these inputs is shown below.

Analog Input Command Values					
VOLT:AC	VOLT:DC	CURR:LIM	FREQ	KVA:LIM	POW:LIM
VOLT:AC1	VOLT:DC1	CURR:LIM1	PHAS2	KVA:LIM1	POW:LIM1
VOLT:AC2	VOLT:DC2	CURR:LIM2	PHAS3	KVA:LIM2	POW:LIM2
VOLT:AC3	VOLT:DC3	CURR:LIM3	OFF	KVA:LIM3	POW:LIM3

Table 7-4: AUX I/O Analog Input assignable Commands

The Gain and Offset parameters can be used to scale and shift the input value to the desired range for min. and max. output.

7.3.14.3 Analog Outputs



Analog outputs allow external equipment to monitor power source output values using an analog DC output signal. The assignment of measurement functions to each of four available outputs can be configured from the front panel.

Available settings are:

- CHANNEL [1 | 2 | 3 | 4]
- OUTPUT VOLTAGE Output setting
- MEASUREMENT Select measurement to be assigned to output
- RANGE 0.0000 to 5.000 V
- GAIN 0.000 to 1000
- OFFSET – 1000 to +1000

7.3.14.4 Digital Inputs

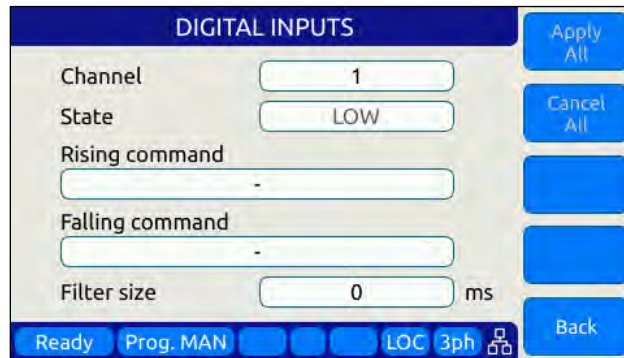

Digital Inputs allow external equipment such as PLCs. to control the power source operation. The assignment functions to each available input can be configured from the front panel.

Available settings are:

- CHANNEL [1 | 2 | 3]
- STATE Displays input state
- RISING CMD Set command string to execute on rising edge
- FALLING CMD Set command string to execute on falling edge
- FILTER SIZE 0 to 10,000,000 msec

7.3.14.5 Digital Outputs

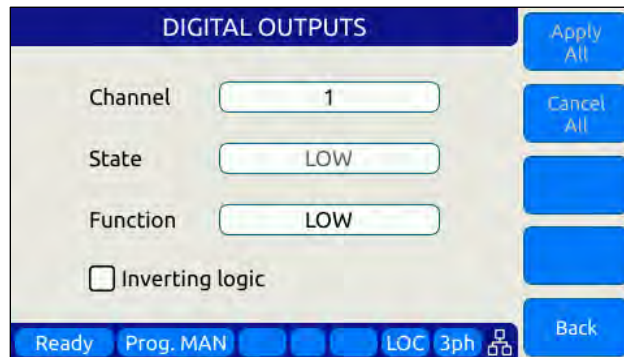

Digital Outputs can be used to trigger or control external equipment. The events assignable to each digital output can be selected using the **Function** field.

Available settings are:

- CHANNEL [1 | 2 | 3 | 4]
- STATE Displays current state
- FUNCTION Assigns state to selected channel. Available states are:
- INV. LOGIC [ON | OFF] Reverses polarity

Events that can be assigned to digital outputs are listed in the table below and can be set using the **Function** field.

Digital Output Assignable Events		
EVENT	Description	Indication
FAULT	Output goes high on fault event	1 = Fault occurred, 0 = No Fault
FORM	Output FORM state	1 = SINGLE, 0 = SPLIT/THREE
HIGH	Fixed Output high	1 = ON
LOW	Fixed Output low	0 = OFF
OUTPUT STATE	Output Relay State	1 = ON (enabled), 0 = OFF (disabled)
PROGRAM	Output goes high when Program is selected	1 = Steady State Program, 0 = Manual mode
REMOTE	Output goes high when unit is in REMOTE state	1 = REMOTE state, 0 = LOCAL state
TRANSIENT	Output goes high when transient is running	1 = Running/Paused/Stepping, 0 = Stopped
XFMR_COUPLING	Indicates output coupling mode	1 = Transformer Coupled, 0 = Direct Coupled

Table 7-5: AUX I/O Digital Output assignable Events or Conditions

7.3.14.6 Polarity Selection for DO3 and DO4 vs DO1 and DO2

The two open drain outputs DO3 and DO4 have internal 1 kΩ pull-up resistors to +5.5V. These outputs can be used as regular digital outputs (open-drain type) if needed. However, the logic will be inverted because a “direct” logic for the relay drive means an “inverted” logic for the open drain output. The FET being on means the relay coil active, but with a pull-up the output goes to low.

DO3 and DO4 use direct logic for the relay drive, which means that if the inverting logic is not active and there is a “1” written to the digital output, an internal FET will be activated causing a “low” in the open drain output.

Each digital output can be configured to have separate inverting logic, so the user can configure these 2 to be inverting and have the normal direct logic when used as open-drain outputs.

7.3.14.7 External Sync

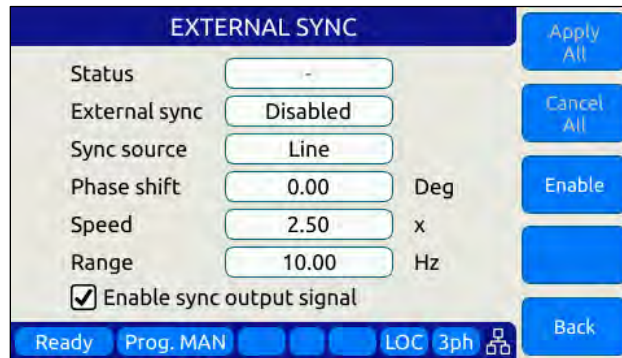

External sync is used to synchronize the power source’s phase A output to an external frequency.

Available settings are:

- STATUS Display SYNC Status
- EXTERNAL SYNC [ON | OFF]
- SYNC SOURCE Select Sync source
- Available sync sources are:
 - External sync input on I/O connector
 - LINE (AC input to power source)
- PHASE SHIFT Offset Phase A angle
- SPEED 1.00 to 10.00
- RANGE 0.10 to 500 Hz
- EXTERNAL SYNC [ON | OFF]

7.3.14.8 Trigger Input

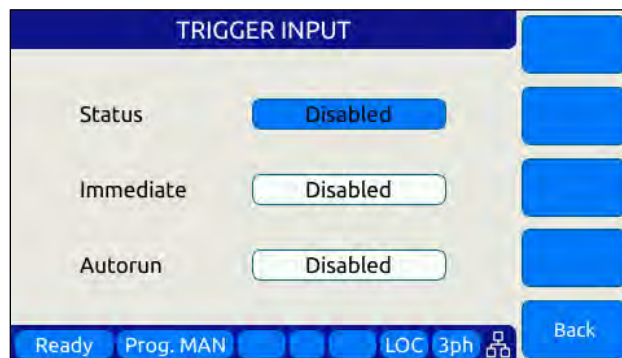

The External Trigger Input can be used to synchronize the power source’s transient execution to external equipment. This

Available settings are:

- STATUS [ON | OFF] Enabled or disabled

- IMMEDIATE [ON | OFF] Ignore phase update setting if ON
- AUTORUN [ON | OFF] No RUN command required if ON

7.3.14.9 Strobe Output

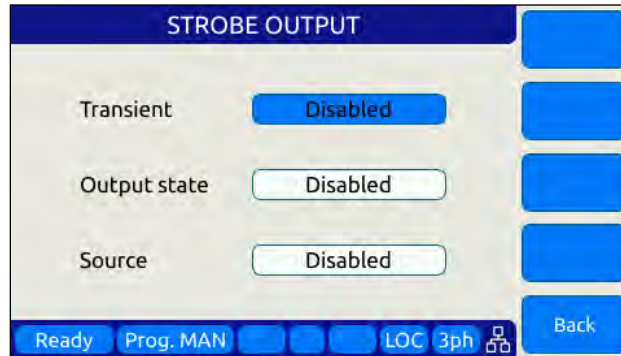

The Strobe Output is used to synchronize or trigger external equipment to an event occurring on the AC power source.

Available settings are:

- TRANSIENT ON = Strobe output on transient start
- OUTPUT STATE ON = Strobe output on relay close
- SOURCE ON = Strobe output on any program parameter change

7.3.14.10 Remote Control

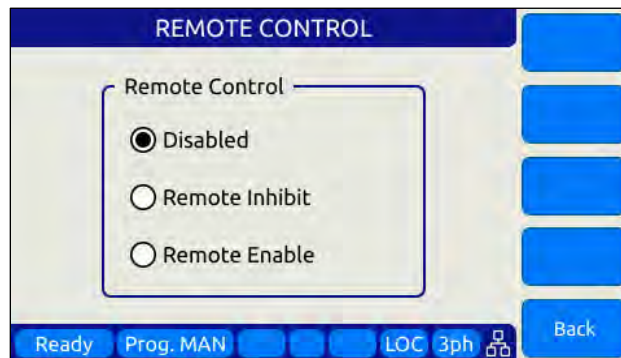

The remote control input is used to control operation of the output relay.

Available settings are:

- DISABLED No remote output control
- REMOTE INHIBIT Contact closure needed to close output relay
- REMOTE ENABLE Contact closure or front panel can control output relay

See Section 6.8.5.6.

8 Remote Control Programming

8.1 Overview

If your unit is fitted with a computer interface option then RS232, USB or LAN connector will be present on the rear panel based on the order configuration. The interface allows the power source settings to be configured remotely and measurement data to be retrieved for analysis and test report generation.

The front panel LOCAL key allows the user to restore LOCAL CONTROL unless the Bus controller has sent a LOCAL LOCKOUT (LLO) message. The Bus Controller may restore LOCAL CONTROL by sending a GOTO LOCAL (GTL) message.

8.1.1 Programming Conventions and Notations

The following conventions and notations are used in this section of the manual:

1. **COMMANDS** are shown in the left hand column in **BOLD** with **NO** underline.
2. Command **DESCRIPTIONS** appear in the right hand column.
3. SCPI is "Standard Commands for Programmable Instruments -1992". Refer to the SCPI 1992 standard for more information. The full standard publication is available from the IVI Foundation at <http://www.ivifoundation.org/>
4. Some SCPI keywords are optional, and are ignored by the device. Optional keywords are enclosed in [] brackets.
5. Lowercase letters of commands shown are also optional.
6. The SCPI standard requires uppercase text in all SCPI commands (start with :), however, the command parser is not case sensitive and will accept commands sent in lower case. It is recommended that programming formats follow the SCPI standard.
7. Some SCPI commands have query command counterparts as noted. A query command consists of the command with a question mark (?) appended at the end. Parameters cannot be sent with a query. IEEE-488.2 commands do not have query counterparts unless explicitly shown with a question mark appended.
8. IEEE488.2 common commands start with an asterisk (*) and are not case sensitive.
9. All required Functional Elements for devices are implemented.
10. All numerical values are ASCII encoded decimal strings consisting of 1 or more ASCII digits. 8 and 16 bit register values are binary weighted values represented by an ASCII string of 1 or more decimal digits. One exception, the Serial Poll byte, is an 8 bit hexadecimal byte.
11. Multiple Commands and Queries may be sent in one Program Message but each must be separated by a semicolon (;). The term 'Program Message' refers to one or more

commands and/or queries sent to the controller as one continuous string and is not to be confused with Stored Programs (1-99) within the controller.

12. Multiple data parameter names and values must be separated by commas.
13. Voltage and Waveform parameter names without a channel number suffix (1,2,3) may be used to set all 3 channels (phases) simultaneously, as an alternative to setting each separately to the same value.
14. Multiple keyword messages may be sent without duplicating the first level SCPI keyword i.e., **SOURce**).
e.g., **:SOURce:VOLTage1,120; FREQuency,60**
A keyword is a single word beginning with a colon (:).
15. Program Messages **MUST** be terminated with a LINE FEED (0Ahex, 10dec) or END (EOI) signal. This is referred to as an end-of-string <eos>. A Carriage Return character (0Dhex, 13dec) is converted to a LINE FEED by the power source. Further SCPI commands shall begin with a first level keyword (i.e., **:SOURce:**).
16. All values shown in angle brackets <> are examples of real values used with commands but labels are sometimes used to indicate a variable which is not known until actual time of use. e.g., <AMPS meter range> might actually be <50>. Units such as AAC, Hz. or % shown after the angle bracketed value are not to be included inside the value, but are shown as a reference to the units. The angle brackets are not part of the value.
17. The controller data input buffer is 8k bytes, as is its data output buffer. No program message may exceed this length.
18. All **:SOURce:** commands also support queries. An alternate method of writing or reading the presently active **:SOURce:FORM**, **COUPLing**, **VOLTage**, **FREQuency**, and **CURRent:LIMit** values is to use **PROGram 0** (see examples). **PROGram 0** contains the **MANUAL MODE** parameters.

NOTE: Sending any **:SOURce:** command invokes **MANUAL MODE** and **REMOTE CONTROL**.
19. Command strings may contain spaces.
20. The controller interface accepts IEEE-488.2 <nr1>, <nr2> and <nr3> numeric formats. Most query responses are <nr1> or <nr2> types. i.e., <nr1>=120, <nr2>=120.0, <nr3>=1.2E+02.
21. Follow any command (in the same Program Message) with ***OPC** to detect completion of the command or termination of a Transient event. An SRQ occurs when the command or Transient is complete (if ESB bit is set in SRE and OPC bit is set in ESE). ***OPC?** may be used in the same manner.

8.1.2 Command Terminators

Allowable terminator characters are:

Character	ASCII	Dec value	Hex value
Carriage Return	<CR>	13	0x0d
Line Feed	<LF>	10	0x0a

8.2 Remote Control Command Descriptions by Subsystem

This section covers detailed description of the available commands by category. The following command categories are defined.

Command Subsystem	Description
CALIBRATE	These commands perform calibration functions
MEASURE	These commands are used to measure voltage, current, power and any other measurement parameters from the instrument.
OUTPUT	These command control the power source output
PROGRAM	These commands control programmed settings and transient segments
SENSE	These commands control the voltage sense modes
SOURCE	These commands are used to set instrument settings
STATUS	These commands are used to control or query status and error messages.
SYSTEM	These commands are used to control system level setting such as interfaces, special operating modes or other special instrument specific functions.

Table 8-1: Available SCPI Command Subsystems

8.3 Calibration Commands

Calibration commands allow for fully automated calibration of the power source.

Note: It is not recommended for the end user to use these command unless calibration must be automated. Any errors in using these commands could invalidate user calibration data. Pacific Power Source recommends the use of a competent and authorized calibration lab to perform routine calibration.

The following calibration commands are supported. Commands marked “UPC” are provided for backward compatibility with UPC controller based PPS power sources.

8.3.1 AZX Calibration Commands

Command Syntax	CALibrate:COEFFicients:OFFSET:VOLTage
Description	Calibrates output DC voltage offset to lowest possible level.
Parameters	None
Parameter Format	n/a
Example	CAL:OFFSET:VOLT

Command Syntax	CALibrate:COEFFicients:OFFSET:CURRent
Description	Calibrates output DC current offset to lowest possible level
Parameters	None
Parameter Format	n/a
Example	CAL:OFFSET:CURR

Command Syntax	CALibrate:COEFFicients:NOISE:VOLTage
Description	Calibrates output voltage noise to lowest possible level.
Parameters	None
Parameter Format	n/a
Example	n/a

Command Syntax	CALibrate:COEFFicients:NOISE:CURRent
Description	Calibrates output current noise to lowest possible level.
Parameters	None
Parameter Format	n/a
Example	n/a

<p>Command Syntax Description</p>	<p>CALibrate:COEFFicients:GAIN:VOLTage[:AC] <cr> Loads values measured with an external DVM for calibration of AC voltage output and metering. The first 3 values are Voltages measured at the output relay of the power source for each phase. The second set of 3 values are Voltages measured at the external voltage sense points (at the load) for each phase.</p>
<p>Parameters Parameter Format Example</p>	<p>External reference voltage readings for each phase n/a n/a</p>
<p>Command Syntax Description</p>	<p>CALibrate:COEFFicients:GAIN:CURREnt[:AC] <cr> Loads values measured with an external shunt and DVM for calibration of AC current metering. The first 3 values are currents measured at the output of the power source for each phase.</p>
<p>Parameters Parameter Format Example Query Format Returned Data Format Query Example</p>	<p>External reference current reading n/a n/a No n/a n/a</p>
<p>Command Syntax Description</p>	<p>CALibrate:COEFFicients:GAIN:VOLTage:DC <cr> Loads values measured with an external DVM for calibration of DC voltage output and metering. The first 3 values are Voltages measured at the output relay of the power source for each phase. The second set of 3 values are Voltages measured at the EXTERNAL Sense point (at the load) for each phase</p>
<p>Parameters Parameter Format Example</p>	<p>None n/a n/a</p>
<p>Command Syntax Description</p>	<p>CALibrate:COEFFicients:GAIN:CURREnt:DC <cr> Loads values measured with an external shunt and DVM for calibration of DC current metering. The first 3 values are currents measured at the output of the power source for each phase.</p>
<p>Parameters Parameter Format Example</p>	<p>None n/a n/a</p>

<p>Command Syntax Description</p>	<p>CALibrate:RESET Clears all calibration coefficients. Sending this command resets all calibration factors to defaults. After sending this command, programming and metering remains functional and will still meet spec.</p>
<p>Parameters Parameter Format Example</p>	<p>None n/a CAL:RESET</p>
<p>Query Format Description Returned Data Format Query Example</p>	<p>CALibrate:COEFFicients:ALL? Returns all eighteen calibration factors as a comma delimited list. <nr1>,...,<nr1> CAL:FACT:ALL? 0,0,0,0,0,0,0,0,0,0,0,0,0,0,0,0,0,0</p>
<p>Command Syntax Description</p>	<p>CALibrate:UPDATE Transfers cal factors from XML Calibration file to NVM. Required only if calibration.xml has been modified. Alternatively, the unit can be power cycled.</p>
<p>Parameters Parameter Format Example</p>	<p>None n/a n/a</p>

8.3.2 UPC Specific commands.

Following commands are included for UPC compatibility mode only and don't perform any function other than providing query responses for use with legacy software programs.

<p>Query Format Query Format Command Syntax</p>	<p>CALibrate:VALue:XFMRRatio? CALibrate:VALue:AMPLIFIERS? CALibrate:KFACTORS <k_int_Va, k_int_Vb, k_int_Vc, k_ext_Va, k_ext_Vb, k_ext_Vc, k_la, k_lb, k_lc, k_oscA, k_oscB, k_oscC></p>
<p>Query Format</p>	<p>CALibrate:KFACTors:ALL?</p>

8.3.3 AUX I/O Interface Calibration Commands

For a list of AUX I/O calibration commands, see Section 8.10.4, "AUX I/O Calibration Command" on page 538.

8.4 Measurement Commands

Measurement commands are typically queries only and return power source measurement data values. This section is broken down into the commands for each measurement parameter.

The following measurement commands are supported.

8.4.1 Voltage Measurement Commands

Query Format Description	MEASure:VOLTage[:ACDC]#? Returns the measured RMS voltage for the selected phase #. If no phase number is specified, returns the reading for the last selected phase.
Returned Data Format Query Example	<nr2> MEAS:VOLT:ACDC2? 230.0000
Query Format Description	MEASure:VOLTage:DC#? Returns the measured DC voltage for the selected phase #. If no phase number is specified, returns the reading for the last selected phase.
Returned Data Format Query Example	<nr2> MEAS:VOLT:DC1? 2.2500
Query Format Description	MEASure:VOLTage:AC#? Returns the measured RMS voltage for the selected phase #. If no phase number is specified, returns the reading for the last selected phase. This command is equivalent to “MEASure:VOLTage[:ACDC]#?” and is provided for backward compatibility with the UPC controllers.
Returned Data Format Query Example	<nr2> MEAS:VOLT:AC3? 230.0000
Query Format Description	MEASure:VOLTage:PEAK#[:ABSolute]? Returns the measured peak voltage value for the selected phase #. If no phase number is specified, returns the reading for all phases.
Returned Data Format Query Example	<nr2> MEAS:VOLT:PEAK? 325.1211, 125.4521, 225.3454

Query Format Description	MEASure:VOLTage:PEAK#[[:ABSolute]:]HOLD? Returns the measured peak hold voltage value for the selected phase #. If no phase number is specified, returns the reading for all phases. This reading accumulates the highest recorded absolute peak voltage until reset using the MEASure:VOLTage:PEAK#:RESet command.
Returned Data Format Query Example	<nr2> MEAS:VOLT:PEAK:HOLD? 326.1211, 128.4521, 229.3454
Query Format Description	MEASure:VOLTage:PEAK#:MINimum? Returns the lowest measured peak voltage value for the selected phase #. If no phase number is specified, returns the reading for all phases.
Returned Data Format Query Example	<nr2> MEAS:VOLT:PEAK:MIN? -325.1211, -125.4521, -225.3454
Query Format Description	MEASure:VOLTage:PEAK#:MINimum:HOLD? Returns the lowest measured peak hold voltage value for the selected phase #. If no phase number is specified, returns the reading for all phases. This reading accumulates the lowest recorded absolute peak hold voltage until reset using the MEASure:VOLTage:PEAK#:RESet command.
Returned Data Format Query Example	<nr2> MEAS:VOLT:PEAK:MIN:HOLD? -326.1211, -128.4521, -229.3454
Query Format Description	MEASure:VOLTage:PEAK#:MAXimum? Returns the highest measured peak voltage value for the selected phase #. If no phase number is specified, returns the reading for all phases.
Returned Data Format Query Example	<nr2> MEAS:Curr:PEAK:MAX? 326.1211, 128.4521, 229.3454
Query Format Description	MEASure:VOLTage:PEAK#:MAXimum:HOLD? Returns the highest measured peak hold voltage value for the selected phase #. If no phase number is specified, returns the reading for all phases. This reading accumulates the highest recorded absolute peak hold voltage until reset using the MEASure:VOLTage:PEAK#:RESet command.
Returned Data Format Query Example	<nr2> MEAS:VOLT:PEAK:MAX:HOLD? 58.5845, 57.3213, 58,2234

Command Syntax Description	MEASure:VOLTage:PEAK#:RESet This command resets all peak hold voltage readings for the selected phase # to zero. If no phase number is specified, returns the reading for all phases to zero.
Parameters	None
Parameter Format	n/a
Example	MEAS:VOLT:PEAK1:RES

Query Format Description	MEASure:VLL#? Returns the measured RMS Line-to-Line voltage ¹ for the selected phase #. If no phase number is specified, returns the reading for the last selected phase. Phase reference applies as follows: # = 1 V _{AB} , # = 2 V _{AC} , # = 3 V _{BC}
Returned Data Format Query Example	MEAS:VLL2? 398.3780

Note 1: Line to Line voltage measurements are calculated based on VLN and phase angles and are valid only for sinusoidal voltage waveforms with low levels of distortion and under balanced three phase load conditions.

Query Format Description	MEASure:VLL:PEAK#[:ABSolute]? Returns the measured peak line to line voltage value for the selected phase #. If no phase number is specified, returns the reading for all phases. Phase reference applies as follows: # = 1 V _{AB} , # = 2 V _{AC} , # = 3 V _{BC}
Returned Data Format Query Example	<nr2> MEAS:VLL:PEAK? 325.1211, 125.4521, 225.3454

Query Format Description	MEASure:VLL:PEAK#[:ABSolute]:HOLD? Returns the measured peak hold line to line voltage value for the selected phase #. If no phase number is specified, returns the reading for all phases. Phase reference applies as follows: # = 1 V _{AB} , # = 2 V _{AC} , # = 3 V _{BC} This reading accumulates the highest recorded absolute peak line to line voltage until reset using the MEASure:VOLTage:PEAK#:RESet command.
Returned Data Format Query Example	<nr2> MEAS:VLL:PEAK:HOLD? 326.1211, 128.4521, 229.3454

Query Format Description	<p>MEASure:VLL:PEAK#:MINimum?</p> <p>Returns the lowest measured peak line to line voltage value for the selected phase #. If no phase number is specified, returns the reading for all phases. Phase reference applies as follows: # = 1 V_{AB}, # = 2 V_{AC}, # =3 V_{BC}</p>
Returned Data Format Query Example	<p><nr2> MEAS:VLL:PEAK:MIN? -325.1211, -125.4521, -225.3454</p>
Query Format Description	<p>MEASure:VLL:PEAK#:MINimum:HOLD?</p> <p>Returns the lowest measured peak hold line to line voltage value for the selected phase #. If no phase number is specified, returns the reading for all phases. This reading accumulates the lowest recorded absolute peak hold line to line voltage until reset using the MEASure:VOLTage:PEAK#:RESet command.</p>
Returned Data Format Query Example	<p><nr2> MEAS:VOLT:PEAK:MIN:HOLD? -326.1211, -128.4521, -229.3454</p>
Query Format Description	<p>MEASure:VLL:PEAK#:MAXimum?</p> <p>Returns the highest measured peak line to line voltage value for the selected phase #. If no phase number is specified, returns the reading for all phases. Phase reference applies as follows: # = 1 V_{AB}, # = 2 V_{AC}, # =3 V_{BC}</p>
Returned Data Format Query Example	<p><nr2> MEAS:Curr:PEAK:MAX? 326.1211, 128.4521, 229.3454</p>
Query Format Description	<p>MEASure:VLL:PEAK#:MAXimum:HOLD?</p> <p>Returns the highest measured peak hold line to line voltage value for the selected phase #. If no phase number is specified, returns the reading for all phases. This reading accumulates the highest recorded absolute peak hold line to line voltage until reset using the MEASure:VOLTage:PEAK#:RESet command.</p>
Returned Data Format Query Example	<p><nr2> MEAS:VLL:PEAK1:MAX:HOLD? 58.5845</p>
Command Syntax Description	<p>MEASure:VLL:PEAK#:RESet</p> <p>This command resets all peak hold line to line voltage readings for the selected phase # to zero. If no phase number is specified, returns the reading for all phases to zero. Phase reference applies as follows: # = 1 V_{AB}, # = 2 V_{AC}, # =3 V_{BC}</p>
Parameters Parameter Format Example	<p>None n/a MEAS:VLL:PEAK1:RES</p>

8.4.2 Frequency Measurement Commands

Query Format	MEASure:FREQuency#?
Description	Returns the fundamental frequency for the selected phase #. If no phase number is specified, returns the reading for the last selected phase. For frequency measurements, the phase reference is irrelevant as all phase are at the same frequency.
Returned Data Format	<nr2>
Query Example	MEAS:FREQ? 50.0000

8.4.3 Current Measurement Commands

Query Format	MEASure:CURRent[:ACDC]#?
Description	Returns the measured RMS current for the selected phase #. If no phase number is specified, returns the reading for the last selected phase.
Returned Data Format	<nr2>
Query Example	MEAS:CURR:ACDC1? 21.1587

Query Format	MEASure:CURRent:PEAK#[:ABSolute]?
Description	Returns the measured peak current value for the selected phase #. If no phase number is specified, returns the reading for all phases.
Returned Data Format	<nr2>
Query Example	MEAS:CURR:PEAK? 45.5845, 47.3213, 48,2234

Query Format	MEASure:CURRent:PEAK#[:ABSolute]:HOLD?
Description	Returns the measured peak hold current value for the selected phase #. If no phase number is specified, returns the reading for all phases. This reading accumulates the highest recorded absolute peak current until reset using the MEASure:CURRent:PEAK#:RESet command.
Returned Data Format	<nr2>
Query Example	MEAS:CURR:PEAK:HOLD? 58.5845, 57.3213, 58,2234

Query Format	MEASure:CURRent:PEAK#:MINimum?
Description	Returns the lowest measured peak current value for the selected phase #. If no phase number is specified, returns the reading for all phases.
Returned Data Format	<nr2>
Query Example	MEAS:CURR:PEAK:MIN? 1.0001, 0.8451, 0.4871

Query Format Description	<p>MEASure:CURRent:PEAK#:MINimum:HOLD?</p> <p>Returns the lowest measured peak hold current value for the selected phase #. If no phase number is specified, returns the reading for all phases. This reading accumulates the lowest recorded absolute peak hold current until reset using the MEASure:CURRent:PEAK#:RESet command.</p>
Returned Data Format Query Example	<p><nr2></p> <p>MEAS:CURR:PEAK:MIN:HOLD?</p> <p>1.0001, 0.8451, 0.4871</p>
Query Format Description	<p>MEASure:CURRent:PEAK#:MAXimum?</p> <p>Returns the highest measured peak current value for the selected phase #. If no phase number is specified, returns the reading for all phases.</p>
Returned Data Format Query Example	<p><nr2></p> <p>MEAS:CURR:PEAK:MAX?</p> <p>45.5845, 47.3213, 48,2234</p>
Query Format Description	<p>MEASure:CURRent:PEAK#:MAXimum:HOLD?</p> <p>Returns the highest measured peak hold current value for the selected phase #. If no phase number is specified, returns the reading for all phases. This reading accumulates the highest recorded absolute peak hold current until reset using the MEASure:CURRent:PEAK#:RESet command.</p>
Returned Data Format Query Example	<p><nr2></p> <p>MEAS:CURR:PEAK:MAX:HOLD?</p> <p>58.5845, 57.3213, 58,2234</p>
Command Syntax Description	<p>MEASure:CURRent:PEAK#:RESet</p> <p>This command resets all peak hold current readings for the selected phase # to zero. If no phase number is specified, returns the reading for all phases.to zero.</p>
Parameters Parameter Format Example	<p>None</p> <p>n/a</p> <p>MEAS:CURR:PEAK1:RES</p>
Query Format Description	<p>MEASure:CURRent:CREST#?</p> <p>Returns the measured current crest factor for the selected phase #. If no phase number is specified, returns the reading for the last selected phase.</p>
Returned Data Format Query Example	<p><nr2></p> <p>MEAS:CURR:CREST1?</p> <p>2.1544</p>

Query Format	MEASure:CURRent:DC#?
Description	Returns the measured DC current for the selected phase #. If no phase number is specified, returns the reading for the last selected phase.
Returned Data Format	<nr2>
Query Example	MEAS:CURR:DC1? 0.0000
Query Format	MEASure:CURRent:AC#?"
Description	Returns the measured RMS current for the selected phase #. If no phase number is specified, returns the reading for the last selected phase. This command is equivalent to "MEASure:CURRent[:ACDC]#?" and is provided for backward compatibility with the UPC controllers.
Returned Data Format	<nr2>
Query Example	MEAS:CURR:AC1? 21.1587

8.4.4 Power Measurement Commands

Query Format	MEASure:POWer#?
Description	Returns the true power for the selected phase # in kW. If no phase number is specified, returns the reading for the last selected phase.
Returned Data Format	<nr2>
Query Example	MEAS:POWer1? 4.4203
Query Format	MEASure:KVA#?
Description	Returns the true apparent for the selected phase # in kVA. If no phase number is specified, returns the reading for the last selected phase.
Returned Data Format	<nr2>
Query Example	MEAS:KVA1? 4.8665
Query Format	MEASure:PF#?
Description	Returns the true apparent for the selected phase # in kVA. If no phase number is specified, returns the reading for the last selected phase.
Returned Data Format	<nr2>
Query Example	MEAS:PF1? 0.9083

8.4.5 KWh Measurement Commands

Query Format	MEASure:KWHour#?
Description	Returns the accumulated energy measurement for the selected phase # in kWh. If no phase number is specified, returns the total summed kWh for all phases.
Returned Data Format	<nr2>
Query Example	MEASure:KWHour? 12.4203
Command Syntax	MEASure:KWHour:RESET
Description	This command resets all energy measurements to zero and resets the time counter.
Parameters	None
Parameter Format	n/a
Example	MEAS:KWH:RESET
Query Format	MEASure:KWHour:ETIME?
Description	This command returns the accumulated energy measurement time in seconds.
Returned Data Format	<nr2>
Query Example	MEAS:KWH:ETIM? 120.5
Command Syntax	MEASure:KWHour[:STATe]
Description	This command enables or disables the KWh measurements. When enabled, the energy time counter starts till reset with the MEASure:KWHour:RESET command.
Parameters	< 1 ON 0 OFF >
Parameter Format	
Example	MEAS:KWH ON
Query Format	MEASure:KWHour[:STATe]?
Description	The query format of this command returns the setting of the KWh measurement as either 1 (ON) or 0 (OFF).
Returned Data Format	<nr1>
Query Example	MEAS:KWH? 1

8.4.6 Other Measurement Commands

Query Format **MEASure:TEMPerature:AMBient?**
 Description Returns the ambient temperature of the power source in degrees celcius.
 Returned Data Format <nr1>
 Query Example MEAS:TEMP:AMB?
 24

Query Format **MEASure:ALL#? <OPTIONAL: List of measurements to return>**
 Description Returns all available parametric measurements for the selected phase # as a comma delimited string. The # is used to specify phase A, B or C using 1, 2 or 3 respectively. If phase reference is omitted, measurement data for all three phases is returned. Measurement values and order for each phase is shown in the table below. Number are for reference onl, not part of returned data string.

Parameter Optionally, the user can pass a subset list of measurement to return in the order specified. (FW rev 3.4.8 or higher)

Parameter	Parameter
1. FREQUENCY	2. VLL AC+DC RMS
3. VLL AC RMS	4. VLL DC
5. VLL PEAK	6. VLL PEAK Track&Hold
7. VLN AC+DC RMS	8. VLN AC RMS
9. VLN DC	10. VLN DC UHA ¹
11. PEAK VLN	12. PEAK VLN Track&Hold
13. CURRENT AC+DC RMS	14. CURRENT AC RMS
15. CURRENT DC	16. CURRENT DC UHA ¹
17. PEAK CURRENT	18. PEAK CURRENT T&H
19. ACTIVE POWER	20. APPARENT POWER
21. POWER FACTOR	22. CREST FACTOR
23. VOLTAGE THD	24. CURREN THD
25. POWER FACTOR ANGLE	25. DISPLACEMENT FACTOR
27. DISTORTION FACTOR	28. KWHour
29. KWH Elapsed Time in seconds	

Note 1: UHA = Ultra High Accuracy Mode.

Returned Data Format <nr2>,<nr2>,...,<nr2>,<nr2>
 Query Example MEAS:ALL1?
 1200.0000,519.5981,519.5981,0.0028,299.9990,299.9989,-
 0.0007,0.1711,-0.0016,0.0000,0.0513,0.4849,0.0000,0.0000

Query Format **MEASure:ALL:CATALOG?**
 Description Returns a comma-separated human-readable list of available measurements in the same order as the command returns it. See MEASure:ALL#? Command for parameter list as a function of Firmware revision. (FW Revision 3.4.8 or higher)

8.4.7 Measurement Data Logging Commands

Command Syntax	MEASure:LOGger:START
Description	Starts the logging of measurements process. The process consists of taking measurements and saving them in a file. The log file can be found in the “datalogger” folder and is a comma separated value format (.csv) file. Measurements will be taken while the output is enabled only.
Parameters	None
Parameter Format	n/a
Example	MEAS:LOG:START
Query Format	None
Command Syntax	MEASure:LOGger:STOP
Description	Stops the logging process that was started with MEASure:LOGger:START.
Parameters	None
Parameter Format	n/a
Example	MEAS:LOG:STOP
Query Format	None
Query Format	MEASure:LOGger:STATe?
Description	Returns the state of the measurement data logging process as a number as follows: 0 – Stopped 1 – Running 2 – Paused
Returned Data Format	<nr1>
Query Example	MEAS:LOG:STAT? 1

<p>Command Syntax Description</p>	<p>MEASure:LOGger:LIMit <cr> Sets the number of samples to get. Once the logging process reach this limit it will stop.If the limit is set as OFF or 0 it will not stop unless MEAS:LOG:STOP is executed. The limit can be specified as a number of samples or in seconds if a character “S” is added to the number. If the limit is passed as seconds, the command will compute the number of samples based on the logging rate. The formula is: number of samples = seconds / rate. The rate can be set with: MEASure:LOGger:RATE <nr1> or queried with: MEASure:LOGger:RATE?. < OFF 0 > XS where X is a time limit in seconds X where X is the limit in number of samples</p>
<p>Parameters</p>	
<p>Parameter Format Examples</p>	<p><cr> MEAS:LOG:LIM OFF MEAS:LOG:LIM 20S MEAS:LOG:LIM 100</p>
<p>Query Format Returned Data Format Query Example</p>	<p>MEASure:LOGger:LIMit? 0 MEAS:LOG:LIM? 10000</p>
<p>Command Syntax Description</p>	<p>MEASure:LOGger:FILELimit <nr1> Sets the limit of samples to save in the file. If the limit is reached and the logging process continues, a new file will be created.</p>
<p>Parameters</p>	<p>Limit in number of samples.</p>
<p>Parameter Format Example</p>	<p><nr1> MEAS:LOG:FILEL 100</p>
<p>Query Format Returned Data Format Query Example</p>	<p>MEASure:LOGger:FILELimit? <nr1> MEAS:LOG:FILEL? 10000</p>
<p>Command Syntax Description</p>	<p>MEASure:LOGger:FILENAME <cr> Sets the data logging file name</p>
<p>Parameters</p>	<p>Filename between double quotes</p>
<p>Parameter Format Example</p>	<p><cr> MEAS:LOG:FILEN “Measurement-AC+DC”</p>
<p>Query Format Returned Data Format Query Example</p>	<p>MEASure:LOGger:FILENAME? <cr> MEAS:LOG:FILEN? Measurement-AC+DC</p>

<p>Command Syntax Description</p>	<p>MEASure:LOGger:MEMory <cr> Select the memory where the logging files will be saved. By default it is RAM unless a memory stick or USB drive was inserted and selected with this command: MEAS:LOG:MEM:CAT? can be used to get the available memories. Memory name between double quotes.</p>
<p>Parameters Parameter Format Example Query Format Returned Data Format Query Example</p>	<p><cr> MEAS:LOG:MEM "USBA" MEASure:LOGger:MEMory? <cr> MEAS:LOG:MEM? USBA</p>
<p>Query Format Description Returned Data Format Query Example</p>	<p>MEASure:LOGger:MEMory:CATalog? Returns the catalog of available memory names. <cr> MEAS:LOG:MEM:CAT? RAM, USBA</p>
<p>Command Syntax Description</p>	<p>MEASure:LOGger:RATE Sets the frequency at which the logging process will take measurements.</p>
<p>Parameters Parameter Format Example Query Format Returned Data Format Query Example</p>	<p>Frequency in Hz. Range is 1 Hz through 10 Hz. <nr1> MEAS:LOG:RATE 5 MEASure:LOGger:RATE? <nr1> MEAS:LOG:RATE? 5</p>
<p>Command Syntax Description</p>	<p>MEASure:LOGger:TIMEstamp <cr> Sets the time stamp format that will be attached to every measurement record in the measurement log file.</p>
<p>Parameters Parameter Format Example Query Format Returned Data Format Query Example</p>	<p>< DATE 0 TIME 1 ALL 2 > <cr> MEAS:LOG:TIME ALL MEASure:LOGger:TIMEstamp? <nr1> MEAS:LOG:TIME? 2</p>

8.4.8 Waveform Capture Commands

Waveform capture commands may be used to retrieve time domain voltage and current waveform captures similar to those of a digital oscilloscope.

Query Format	FETCH:WAVEform:VOLTage#?
Description	Returns time domain data for voltage on selected phase #. # = 1, 2 or 3. Returns a string of <nr2> type numbers, comma delimited. Only a single waveform may be queried in a command. Note: In UPC Compatibility mode, a total of 512 data points are returned. In AZX mode, 1024 data points are returned.
Returned Data Format	<nr2>, <nr2>, <nr2>,....., <nr2>
Query Example	FETCH:WAVE:VOLT1? 0.000, 0.0001, 0.0003....., 0.000
Query Format	FETCH[:WAVEform]:VLL#?
Description	Returns time domain data for voltage on selected Line to Line voltage #. # = 1, 2 or 3. Returns a string of <nr2> type numbers, comma delimited. Only a single waveform may be queried in a command. Note: In UPC Compatibility mode, a total of 512 data points are returned. In AZX mode, 1024 data points are returned.
Returned Data Format	<nr2>, <nr2>, <nr2>,....., <nr2>
Query Example	FETCH:WAVE:VLL1? 0.000, 0.0001, 0.0003....., 0.000
Query Format	FETCH:WAVEform:CURREnt#?
Description	Returns time domain data for current on selected phase #. # = 1, 2 or 3. Returns a string of <nr2> type numbers, comma delimited. Only a single waveform may be queried in a command. Note: In UPC Compatibility mode, a total of 512 data points are returned. In AZX mode, 1024 data points are returned.
Returned Data Format	<nr2>, <nr2>, <nr2>,....., <nr2>
Query Example	FETCH:WAVE:CURREnt? 0.000, 0.0001, 0.0003....., 0.000
Query Format	FETCH:WAVEform:INFO?
Description	Returns the output measurement frequency, date and time of capture for the last waveform data fetched.
Returned Data Format	<nr2>, <dd/mm/yyyy>, <hh:mm:ss>
Query Example	FETCH:WAVE:INFO? 400.000, "05/21/2019", "14:34:20"

Query Format	FETCH:WAVEform:PERIOD?
Description	Returns the number of periods captured. Minimum period is 1, max no. of periods is 4.
Returned Data Format	<nr2>, <dd/mm/yyyy>, <hh:mm:ss>
Query Example	FETCH:WAVE:PERIOD? 400.000, "05/21/2019", "14:34:20"

8.4.9 Harmonic Measurements Commands

Harmonic Measurements commands may be used to retrieve harmonic analysis data for voltage and current. These measurements are returned using the SPECTrum commands.

Query Format	MEASure:SPECTrum:VOLTage#[:MAGnitude]?
Description	Returns harmonics spectrum for voltage on selected phase #. # = 1, 2 or 3. Returns a data set of 51, <nr2> type numbers, comma delimited. The 1 st element is the magnitude of the fundamental, for reference. The 2 nd element is the 2 nd harmonic, etc. Values represent % of fundamental (relative). Only a single spectrum may be queried in a command.
Returned Data Format	<nr2>, <nr2>, <nr2>,....., <nr2>
Query Example	MEAS:SPECT:VOLT1? 100.000, 0.001, 0.3....., 0.000
Query Format	MEASure:SPECTrum:VLL#[:MAGnitude]?
Description	Returns harmonics spectrum for three phase Line to Line voltage on selected phase #. # = 1, 2 or 3 (1 = Vab, 2 = Vbc, 3 = Vac). Returns a VLL data set of 51, <nr2> type numbers, comma delimited. The 1 st element is the magnitude of the fundamental, for reference. The 2 nd element is the 2 nd harmonic, etc. Values represent % of fundamental (relative). Only a single spectrum may be queried in a command.
Returned Data Format	<nr2>, <nr2>, <nr2>,....., <nr2>
Query Example	MEAS:SPECT:VLL1? 207.000, 0.001, 0.3....., 0.000
Query Format	MEASure:SPECTrum:VLL#:ABSolute?
Description	Returns absolute harmonics spectrum for three phase Line to Line voltage on selected phase #. # = 1, 2 or 3 (1 = Vab, 2 = Vbc, 3 = Vac). Returns a VLL data set of 51, <nr2> type numbers, comma delimited. The 1 st element is the magnitude of the fundamental, for reference. The 2 nd element is the 2 nd harmonic, etc. Values represent % of fundamental (relative). Only a single spectrum may be queried in a command.
Returned Data Format	<nr2>, <nr2>, <nr2>,....., <nr2>
Query Example	MEAS:SPECT:VLL1:ABS? 207.000, 0.001, 0.3....., 0.000

Query Format Description	<p>MEASure:SPECTrum:CURRent#[:MAGnitude]?</p> <p>Returns harmonics spectrum for current on selected phase #. # = 1, 2 or 3. Returns a data set of 51, <nr2> type numbers, comma delimited. The 1st element is the magnitude of the fundamental, for reference. The 2nd element is the 2nd harmonic, etc. Values represent % of fundamental (relative).</p> <p>Only a single spectrum may be queried in a command.</p>
Returned Data Format Query Example	<p><nr2>, <nr2>, <nr2>,....., <nr2></p> <p>MEAS:SPECT:CURR1?</p> <p>4.6300, 0.001, 0.23....., 0.000</p>
Command Syntax Description	<p>MEASure:SPECTrum:PHASe:REFerence</p> <p>This command sets the phase reference for the harmonic analysis measurement function.</p>
Parameters	<p>Available settings are:</p> <ul style="list-style-type: none"> 0 None. 1 (DEFAULT) All phases measurements are referenced to phase A voltage. 2 Voltage and current phases measurements are referenced to the voltage of the same phase (A, B or C) 3 Voltage phase measurements are referenced to the voltage of the same phase (A, B or C). Current phase measurements are referenced to the current of the same phase (A, B or C)
Parameter Format Example	<nr1>
Query Format	MEAS:SPECT:PHAS:REF 2
Returned Data Format	MEASure:SPECTrum:PHASe:REFerence?
Query Example	<nr1> MEAS:SPECT:PHAS:REF? 2
Query Format Description	<p>MEASure:SPECTrum:PHASe?</p> <p>Returns phase angles in degrees for the most recent voltage or current spectrum query. Returns a data set of 51, <nr2> type numbers, comma delimited. The 1st element is the phase angle of the fundamental, for reference. The 2nd element is the phase angle of the 2nd harmonic, etc.</p>
Returned Data Format Query Example	<p><nr2>, <nr2>, <nr2>,....., <nr2></p> <p>MEAS:SPECT:PHAS?</p> <p>0.000, 20.000, 30.000....., 0.000</p>

<p>Query Format Description</p>	<p>MEASure:SPECTrum:VOLTage#:PHASe? Same as “MEASure:SPECTrum:PHASe?” but selects voltage and phase #. Returns phase angles in degrees for the most recent voltage spectrum query. Returns a data set of 51, <nr2> type numbers, comma delimited. The 1st element is the phase angle of the fundamental, for reference. The 2nd element is the phase angle of the 2nd harmonic, etc.</p>
<p>Returned Data Format Query Example</p>	<p><nr2>, <nr2>, <nr2>,....., <nr2> MEAS:SPECT:VOLT1:PHAS? 0.000, 20.000, 30.000....., 0.000</p>
<p>Query Format Description</p>	<p>MEASure:SPECTrum:VLL#:PHASe? Same as “MEASure:SPECTrum:PHASe?” but selects Line to Line voltage and phase #. Returns phase angles in degrees for the most recent voltage spectrum query. Returns a data set of 51, <nr2> type numbers, comma delimited. The 1st element is the phase angle of the fundamental, for reference. The 2nd element is the phase angle of the 2nd harmonic, etc.</p>
<p>Returned Data Format Query Example</p>	<p><nr2>, <nr2>, <nr2>,....., <nr2> MEAS:SPECT:VLL1:PHAS? 0.000, 20.000, 30.000....., 0.000</p>
<p>Query Format Description</p>	<p>MEASure:SPECTrum:CURREnt#:PHASe? Same as “MEASure:SPECTrum:PHASe?” but selects current and phase #. Returns phase angles in degrees for the most recent current spectrum query. Returns a data set of 51, <nr2> type numbers, comma delimited. The 1st element is the phase angle of the fundamental, for reference. The 2nd element is the phase angle of the 2nd harmonic, etc.</p>
<p>Returned Data Format Query Example</p>	<p><nr2>, <nr2>, <nr2>,....., <nr2> MEAS:SPECT:CURR:PHAS? 0.000, 20.000, 30.000....., 0.000</p>
<p>Query Format Description</p>	<p>MEASure:SPECTrum:THD? Returns Total Harmonic Distortion of the most recent :MEASure:SPECTrum:parameter command</p>
<p>Returned Data Format Query Example</p>	<p><nr2> MEAS:SPECT:THD? 2.5600</p>
<p>Query Format Description</p>	<p>MEASure:SPECTrum:VOLTage#:THD? Same as “MEASure:SPECTrum:THD?” but selects voltage and phase #.Returns Total Harmonic Distortion of the selected phase voltage.</p>
<p>Returned Data Format Query Example</p>	<p><nr2> MEAS:SPECT:VOLT1:THD? 2.5600</p>

Query Format Description	MEASure:SPECTrum:VLL#:THD? Same as “MEASure:SPECTrum:THD?” but selects Line to Line voltage #.Returns Total Harmonic Distortion of the selected Line to Line voltage.
Returned Data Format Query Example	<nr2> MEAS:SPECT:VLL1:THD? 2.5600
Query Format Description	MEASure:SPECTrum:CURREnt#:THD? Same as “MEAS:SPECTrum:THD?” but selects current and phase #.Returns Total Harmonic Distortion of the selected phase currebt.
Returned Data Format Query Example	<nr2> MEAS:SPECT:CURR1:THD? 2.5600
Query Format Description	MEASure:SPECTrum:EHD? Returns Even Harmonic Distortion of the most recent :MEASure:SPECTrum:parameter command
Returned Data Format Query Example	<nr2> MEAS:SPECT:EHD? 3.5690
Query Format Description	MEASure:SPECTrum:VOLTage#:EHD? Same as “MEAS:SPECTrum:EHD?” but selects voltage and phase #.Returns Even Harmonic Distortion of the selected phase voltage.
Returned Data Format Query Example	<nr2> MEAS:SPECT:VOLT1:EHD? 10.5891
Query Format Description	MEASure:SPECTrum:VLL#:EHD? Same as “MEAS:SPECTrum:EHD?” but selects Line to Line voltage #.Returns Even Harmonic Distortion of the selected Line to Line voltage.
Returned Data Format Query Example	<nr2> MEAS:SPECT:VLL1:EHD? 10.5891
Query Format Description	MEASure:SPECTrum:CURREnt#:EHD? Same as “MEAS:SPECTrum:EHD?” but selects current and phase #.Returns Even Harmonic Distortion of the selected phase currebt.
Returned Data Format Query Example	<nr2> MEAS:SPECT:CURR1:EHD? 22.5948

Query Format	MEASure:SPECTrum:OHD?
Description	Returns Odd Harmonic Distortion of the most recent :MEASure:SPECTrum:parameter command
Returned Data Format	<nr2>
Query Example	MEAS:SPECT:OHD? 3.5690
Query Format	MEASure:SPECTrum:VOLTage#:OHD?
Description	Same as “MEAS:SPECTrum:OHD?” but selects voltage and phase #.Returns Odd Harmonic Distortion of the selected phase voltage.
Returned Data Format	<nr2>
Query Example	MEAS:SPECT:VOLT1:OHD? 10.5891
Query Format	MEASure:SPECTrum:VLL#:OHD?
Description	Same as “MEAS:SPECTrum:OHD?” but selects Line to Line voltage #.Returns Odd Harmonic Distortion of the selected Line to Line voltage.
Returned Data Format	<nr2>
Query Example	MEAS:SPECT:VOLT1:OHD? 10.5891
Query Format	MEASure:SPECTrum:CURREnt#:OHD?
Description	Same as “MEAS:SPECTrum:OHD?” but selects current and phase #.Returns Odd Harmonic Distortion of the selected phase currebt.
Returned Data Format	<nr2>
Query Example	MEAS:SPECT:CURR1:OHD? 22.5948

8.4.10 Measurement Resolution Setting Commands

All SCPI measurement commands return measurement data in a format with a specific resolution, i.e. a certain number of digits after the decimal point. The default resolution (number of positions after the decimal point) for each parameter is chosen based on the dimension (VA or KVA) and measurement accuracy of that specific parameter.

The user can increase or decrease the number of digits for each measurement parameter if so desired by using the RESolution commands listed in this section³.

Note: Increasing the resolution of a measurement for any parameter does NOT improve the specified measurement's accuracy specification. As such, digits added for to any measurement may not represent meaningful information.

The generic format for this command is:

MEASure:MMMnnn:RESolution <RESOLUTION>

MEASure:MMMnnn:RESolution?

Where MMMnnn is the measurement command syntax of the measurement for which the resolution is to be set. The Query command can be used to query a command's active resolution setting.

<RESOLUTION> is a formatted number that specifies the number of digits to include in the query response. For example:

0.1	Only one digit behind the decimal point
0.0001	4 digits behind the decimal point
0.00001	6 digits behind the decimal point

Example:

MEASure:POWer:RESolution 0.00001

This changes the number of digits for True Power measurements from the default 4 to 5. Since Power measurements are reported in KW, this is equivalent to changing the measurement resolution from 0.1 W /10mW to 0.01W / 10mW. All these settings are independent of each other so only the specified measurement command's resolution will be changed. To change multiple commands, send this command for each one.

Note: Changing the resolution for any measurement command does NOT affect the displayed resolution of measurements in any of the power sources' front panel display screen. This command only affects remote control bus measurement queries.

Note: Once a command's resolution has been changed using the MEASure:MMMnnn:RESolution <RESOLUTION> command, the new resolution format is persistent, i.e. it remains in effect between power on/off cycles. To change it back, a new RESolution command must be sent.

³ Requires Firmware Revision 2.2.11 or higher

8.5 Output Control Commands

The output command subsystem is used to control the output state of the power source.

Command Syntax Description	OUTPut[:STATe] Enables or Disables power output. When enabled, all output relays are closed. When disabled, all output relays are open. The power source has a standby mode which can be enabled when the output relay is in the OFF state. In this mode, all fans and power stages are turned off to reduce power consumption. Only the AC input transformer remains energized. Typical power consumption in each mode is as follows: Output State ON, no load connection: 1100 Watt Output State Off: 800 Watt / 1500 VA Output State Off & Standby Mode: 500 Watt
Parameters Parameter Format Example Query Format Returned Data Format Query Example	< 0 OFF 1 ON > OUTP ON OUTPut[:STATe]? OUTP? 1
Command Syntax Description	OUTPut[:STATe]:ALL This command enables or disables the output and is similar to the OUTPut[:STATe] command but always turns off all power stages, regardless of the energy savings mode set with the OUTP:FAST command. Thus, the OUTP:ALL OFF command will turn off all power stages and put the AC source in sleep mode. Note: The OUTP:ALL ON command has the same effect as the OUTP ON command.
Parameters Parameter Format Example	< 0 OFF 1 ON > OUTP:ALL OFF

<p>Command Syntax Description</p> <p>OUTPut:AUTO = ON</p> <p>OUTPut:AUTO = OFF</p> <p>Parameters Parameter Format Example Query Format Returned Data Format Query Example</p>	<p>OUTPut[:STATe]:AUTO</p> <p>This commands determines the state of the OUTPUT when the power source is turned on (powered on).</p> <p>The output will be enabled at power on IF it was ON at the time the front panel circuit breaker of the unit was switched off. Thus, the output state will revert to the last state before power-off. This command in combination with the “[SOURce:]INITial” command allows the unattended resumption of a test station after a power failure.</p> <p>Note: This condition is potentially hazardous and should be used with caution.</p> <p>The output will always come up in the OFF state.</p> <p>< 0 OFF 1 ON ></p> <p></p> <p>OUTP:AUTO ON</p> <p>OUTPut[:STATe]:AUTO?</p> <p></p> <p>OUTP:AUTO?</p> <p>1</p>
<p>Command Syntax Description</p> <p>Parameters Parameter Format Example Query Format Returned Data Format Query Example</p>	<p>OUTPut:CAPacitor[:CONTRol]# < 0 1 ></p> <p>Sets the capacitance of the selected phase or all phases if phase reference is omitted to 2.2 uF (0) or 11 uF (1) per inverter module. # = 1, 2 or 3.</p> <p>Note: AZX in the low range has two modules per phase in parallel giving 4.4uF or 22uF.</p> <ul style="list-style-type: none"> • In the high range, the modules are in series, so 1.1uF or 5.5uF. • In single all phases are connected in parallel, so the capacitance is multiplied by three. • With units in parallel, the capacitance is multiplied also by the number of units in parallel. • For high impedance operation if the rise/fall time is not a problem it is recommended to use more capacitance to reduce the rise rate of the voltage <p>< 0 1 ></p> <p></p> <p>OUTP:CAP:CONT2 1</p> <p>OUTPut:CAPacitor[:CONTRol]#?</p> <p></p> <p>OUTP:CAP:CONT1?</p> <p>0</p>
<p>Query Format Description</p> <p>Returned Data Format Query Example</p>	<p>OUTPut:CAPacitor:STATe#?</p> <p>Returns the state of the Capacitor selection of the selected phase inverter module.</p> <p></p> <p>OUTP:CAP:STAT1?</p> <p>1</p>

<p>Command Syntax</p> <p>Description</p>	<p>OUTPut:DISABLEPHase</p> <p>This command sets the disable phase angle. This is the phase angle on phase A at which the power source output will be disabled. Available range is 0 ~ 360. Also allows a negative number that indicates a RANDOM phase angle. Refer also to the OUTPut:ZEROpogram command.</p>
<p>Parameters</p> <p>Parameter Format</p> <p>Example</p>	<p>0.0 ~ 360.0 or negative number</p> <p><nr2></p> <p>OUTPDISABLEPH 90.0</p> <p>OUTPDISABLEPH -1</p>
<p>Query Format</p> <p>Returned Data Format</p> <p>Query Example</p>	<p>OUTPut:DISABLEPHase?</p> <p><nr2></p> <p>OUTP:DISABLEPH?</p> <p>90.000</p>
<p>Query Syntax</p>	<p>OUTPut:DISABLEPHase:MINimum</p> <p>OUTPut:DISABLEPHase:MAXimum</p> <p>OUTPut:DISABLEPHase:DEFault</p>
<p>Description</p>	<p>These query commands return minimum, maximum and default Output Disable Phase values respectively. Available range is -0.01 (Random) through 360.0.</p>
<p>Returned Data Format</p> <p>Query Example</p>	<p><nr2></p> <p>OUTP:DISABLEPH:MIN?</p> <p>-0.010</p> <p>OUTP:DISABLEPH:MAX?</p> <p>360.000</p> <p>OUTP:DISABLEPH:DEF?</p> <p>0.000</p>

<p>Command Syntax Description</p>	<p>OUTPut:ZEROprogram</p> <p>This command sets the programmed output voltage to zero before opening the output relay when the OUTP OFF 0 command is sent. This feature is disabled by default but can be enabled by sending OUTP:ZERO ON 1.</p> <p>In this mode, the output of the power source goes to a low impedance state for 100 msec before disconnecting the load (output relay open) unless RAMP and DELAY are changed.</p> <p>Note: Available in units with Firmware revision 1.6.6 or higher. Refer also to the OUTPut:DISABLEPhase command.</p>
<p>Parameters Parameter Format Example Query Format Returned Data Format Query Example</p>	<p>< 0 OFF 1 ON ></p> <p></p> <p>OUTP:ZERO 1</p> <p>OUTPut:ZEROprogram?</p> <p></p> <p>OUTP:ZERO?</p> <p>1</p>
<p>Command Syntax Description</p>	<p>OUTPut:ZEROprogram:RAMP <nr1></p> <p>This command sets the voltage ramp down to zero time before opening the output relay when the OUTP OFF 0 command is sent. See Figure for reference. Default value is 0 msec.</p> <p style="color: #0070C0;">Delay is 100ms and ramp 0ms by default but can be changed to any value. The ramp allows the voltage to reduce slowly, useful for reducing the magnetization of the transformer so at the next turn on, there is no excessive peak current due to remaining magnetization.</p>
<p>Parameters Parameter Format Example Query Format Returned Data Format Query Example</p>	<p>Time in msecs.</p> <p><nr1></p> <p>OUTP:ZERO:RAMP? 50</p> <p>OUTPut:ZEROprogram:RAMP?</p> <p><nr1></p> <p>OUTP:ZERO:RAMP?</p> <p>50</p>
<p>Command Syntax Description</p>	<p>OUTPut:ZEROprogram:DWELL <nr1></p> <p>This command sets the voltage dwell time before opening the output relay when the OUTP OFF 0 command is sent. See Figure for reference. Default value is 100 msec.</p> <p>Note: Available in units with Firmware revision 2.2.12 or higher.</p>
<p>Parameters Parameter Format Example Query Format Returned Data Format Query Example</p>	<p>Time in msecs.</p> <p><nr1></p> <p>OUTP:ZERO:DWELL? 20</p> <p>OUTPut:ZEROprogram:DWELL?</p> <p><nr1></p> <p>OUTP:ZERO:DWELL?</p> <p>20</p>

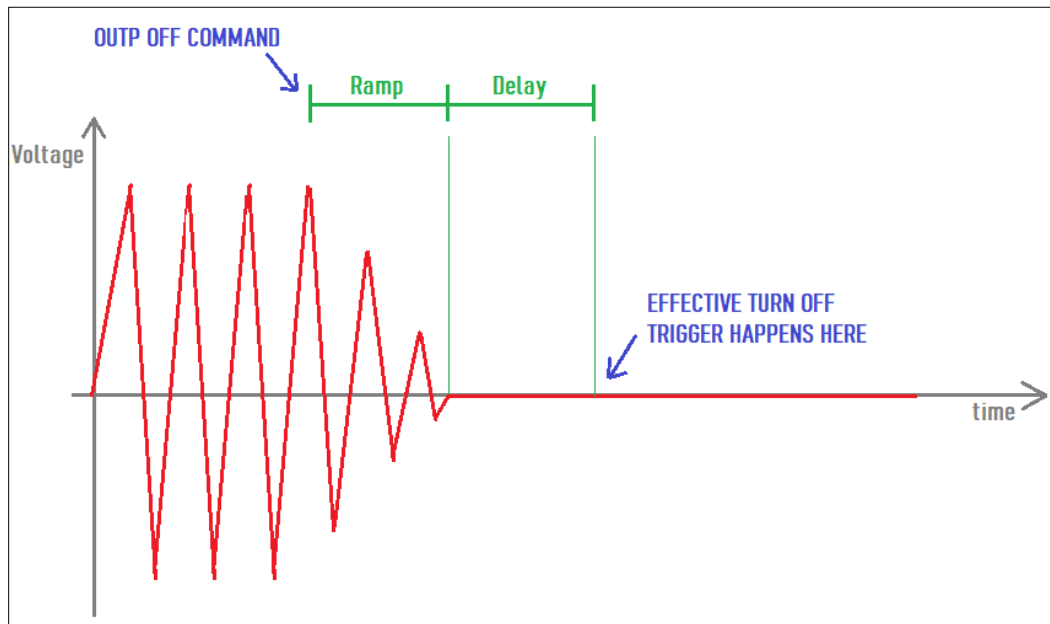

Figure 8-1: OUTPUT:ZERO Command Ramp and Dwell settings

8.6 Program Commands

Program commands allow management and programming of stored program segments for steady state and Transients. These commands are grouped by the following subsystems.

- Program Control Commands
- Execution Commands
- Transient Segment Commands
- Memory Management Commands

The Program commands are similar to those found on the Pacific Power UPC controllers used for other PPS AC power source models.

8.6.1 Program Control Commands

The following commands allow recall of stored programs and transient segments. Programs are selected and recalled using their memory location reference ranging from 1 through 99. Program location zero (0) is reserved for the Manual Mode setup. Optionally, a memory source may be specified. If none is provided, INTERNAL memory is used as a default.

Command Syntax	PROG ram:NAME [<nr1>,<cr>] [<cr>,<cr>] <cr>
Description	This command selects program <nr1> for execution deletion or copying.
Parameters	Option: PROGRAM, NUMBER [,<cr>} or [,<nr1>] - 0 through 99 Option: MEMORY [,<cr>} – Available are: INTERNAL RAM USB Parameter list define string <cr>,<cr>,<cr>,<cr>,<cr>
Parameter Format	<nr1> [,<cr>]
Example	PROG:NAME 4, USB
Query Format	PROG ram:NAME?
Description	The query format of this command returns the value of last program selected. Returned value range is 0 through 99.
Returned Data Format	<nr1>
Query Example	PROG:NAME? 4

Command Syntax Description	<p>PROGram[:SELEcted]:DEFine [<nr1>] [<cr>] <cr></p> <p>This command programs all values stored in the selected program number. Both steady-state and transient segment parameter names and values may be sent. Program parameters are defined in the following sections.</p> <p>NOTE: Only commas may separate the values, NO Carriage Returns or Line Feeds may separate the values within a single command message.</p>
Parameters	<p>Option: PROGRAM, NUMBER [,<cr>} or [,<nr1>]</p> <p>Option: MEMORY [,<cr>] – Available are: INTERNAL RAM USB</p> <p>Parameter list define string <cr>,<cr>,...,<cr></p> <p>Note 1: All the tags must be uppercase.</p> <p>Note 2:The order on the transient/step tags must be sequential.</p>
Steady State list Tags	<p>FORM,<n>, COUPLing,<s>, XFMRRATIO,<n.nn>, FREQUency,<n>, VOLTage,<n>, see Convention #13. VOLTage1,<n>, VOLTage2,<n>, VOLTage3,<n>, CURRent:LIMit,<n>, CURRent:PROTect:LEVel,<n> CURRent:PROTect:TOUT,<n> PHASe2,<n>, PHASe3,<n>, WAVEFORM,<n>, see Convention #13. WAVEFORM1,<n>, WAVEFORM2,<n>, WAVEFORM3,<n>, EVENTS,<n>, AUTORMS,<n> NSEGS, <n></p>
Optional Transient SEGment list Tags	<p>SEGment,<n>, Multiple segments per Program Message may be sent, see Convention 17.</p> <p>FSEG,<n>, VSEG,<n>, AC Voltage, see Convention #13. VSEG1,<n>, VSEG2,<n>, VSEG3,<n>, VSEGDC, <n> DC Voltage, see Convention #13. VSEGDC1, <n> VSEGDC2, <n> VSEGDC3, <n> PSEG1, <n> Cmd available for FW 3.6.x or higher only PSEG2, <n> PSEG3, <n> WFSEG,<n> see Convention #13. WFSEG1,<n>, WFSEG2,<n>, WFSEG3,<n>, TSEG,<n>, LAST Sent only if this is the LAST segment.</p>

Optional Transient STEP list Tags	<p>A STEP is composed of two segments, a ramp segment and at dwell segment. Multiple STEPs per Program Message may be sent, see Convention 17.</p> <p> FSTEP,<n> VSTEP,<n>, see Convention #13. VSTEP1,<n> VSTEP2,<n> VSTEP3,<n> VSTEPDC,<n>, see Convention #13. VSTEPDC1,<n> VSTEPDC2,<n> VSTEPDC3,<n> PSETEP1, <n> PSTEP2, <n> PSTEP3, <n> WFSEG,<n>, see Convention #13. WFSEG1,<n> WFSEG2,<n> WFSEG3,<n> RTSTEP,<n>, Ramp time DTSTEP,<n>, Dwell time LAST Sent only if this is the LAST segment. </p>
Parameter Format	<cr>,<cr>,.....,<cr>,<cr>
Query Format	PROG[<i>:SElected</i>]:DEFine? [<i><nr1></i>,] [<i><cr></i>,]
Description	The Query format returns steady-state values of selected program and segment values of most recently selected segment or multiple segments if specified by a previous NSEGS parameter. "LAST" is returned with segment data if the segment is the last segment in the program.
Returned Data Format	Refer to parameter lists shown above
Query Example	PROG:DEF? 6 <nr1>, <cr>,.....,<cr>

Segment Example Program Strings:

TRANSIENT EXECUTION

RUN **STOP** **STEP** **RESTART**

STATE: **STOPPED**

PROGRESS: 0%

REPEAT TIMES COUNTER: 0

CONFIGURATION: **SETTINGS**

RUN FROM SEGMENT #: 1

RUN TO SEGMENT #: 2

REPEAT TIMES: Infinite

APPLY CANCEL

TRANSIENT TABLE

MODE: **STEP** **SEGMENT** EDIT MODE: **CYCLE BASED** **TIME BASED**

#	TIME [ms]	FREQ [Hz]	V _{AC} [V _{RMS}] A/B/C	V _{DC} [V] A/B/C	Waveform [#] A/B/C	Phase [Deg] A/B/C	
1	100.0	60.00	0.00	0.00	1	0.00/120.00/240.00	+ X
2	100.0	60.00	0.00	0.00	1	0.00/120.00/240.00	+ X

APPLY CANCEL

PROGram:DEFine

```
FORM,3,COUPL,DIRECT,VOLT:MODE,2,CONFIG,0,RANG,0,FREQ,60.000,VOLT1,0.000,VOLT2,0.000,VOLT3,0.000,VOLT:ALC:STAT,1,CURR:OV,0,CURR:LIM1,130.000,CURR:LIM2,130.000,CURR:LIM3,130.000,IPROT:STAT,0,CURR:PROT:LEV,130.000,IPEAK:LIM,360.000,PHAS1,0.000,PHAS2,120.000,PHAS3,240.000,WAVEFORM1,1,WAVEFORM2,1,WAVEFORM3,1,VOLT:DC1,0.000,VOLT:DC2,0.000,VOLT:DC3,0.000,POW:LIM1,17.2500,POW:LIM2,17.2500,POW:LIM3,17.2500,KVA:LIM1,17.2500,KVA:LIM2,17.2500,KVA:LIM3,17.2500,PPROT:STAT,0,POW:PROT:LEV,17.2500,KVA:PROT:LEV,17.2500,PROT:TDELAY,5,FREQ:SLEW,5.000,VOLT:SLEW,10.000,VOLT:DC:SLEW,10.000,UPDATEPH,0.000,RAMP,0.0002,VPEAK:MARG,100.000,EVENTS,0,AUTORMS,1,SEG,1,FSEG,60.00,VSEG1,0.00,VSEG2,0.00,VSEG3,0.00,VDCSEG1,0.00,VDCSEG2,0.00,VDCSEG3,0.00,PSEG2,120.00,PSEG3,240.00,WFSEG1,1,WFSEG2,1,WFSEG3,1,TSEG,0.1000,SEG,2,FSEG,60.00,VSEG1,0.00,VSEG2,0.00,VSEG3,0.00,VDCSEG1,0.00,VDCSEG2,0.00,VDCSEG3,0.00,PSEG2,120.00,PSEG3,240.00,WFSEG1,1,WFSEG2,1,WFSEG3,1,TSEG,0.1000,LAST (Note I removed NSEGS,2 PSEG1,0.00)
```

PROGram:DEFine:ALL?

```
FORM,3,COUPL,DIRECT,VOLT:MODE,2,CONFIG,0,RANG,0,FREQ,60.000,VOLT1,0.000,VOLT2,0.000,VOLT3,0.000,VOLT:ALC:STAT,1,CURR:OV,0,CURR:LIM1,130.000,CURR:LIM2,130.000,CURR:LIM3,130.000,IPROT:STAT,0,CURR:PROT:LEV,130.000,IPEAK:LIM,360.000,PHAS1,0.000,PHAS2,120.000,PHAS3,240.000,WAVEFORM1,1,WAVEFORM2,1,WAVEFORM3,1,VOLT:DC1,0.000,VOLT:DC2,0.000,VOLT:DC3,0.000,POW:LIM1,17.2500,POW:LIM2,17.2500,POW:LIM3,17.2500,KVA:LIM1,17.2500,KVA:LIM2,17.2500,KVA:LIM3,17.2500,PPROT:STAT,0,POW:PROT:LEV,17.2500,KVA:PROT:LEV,17.2500,PROT:TDELAY,5,FREQ:SLEW,5.000,VOLT:SLEW,10.000,VOLT:DC:SLEW,10.000,UPDATEPH,0.000,RAMP,0.0002,VPEAK:MARG,100.000,EVENTS,0,AUTORMS,1,NSEGS,2,SEG,1,FSEG,60.00,VSEG1,0.00,VSEG2,0.00,VSEG3,0.00,VDCSEG1,0.00,VDCSEG2,0.00,VDCSEG3,0.00,PSEG1,0.00,PSEG2,120.00,PSEG3,240.00,WFSEG1,1,WFSEG2,1,WFSEG3,1,TSEG,0.1000,SEG,2,FSEG,60.00,VSEG1,0.00,VSEG2,0.00,VSEG3,0.00,VDCSEG1,0.00,VDCSEG2,0.00,VDCSEG3,0.00,PSEG1,0.00,PSEG2,120.00,PSEG3,240.00,WFSEG1,1,WFSEG2,1,WFSEG3,1,TSEG,0.1000,LAST
```

Step Example Program Strings:

TRANSIENT EXECUTION

RUN STOP STEP RESTART RUN FROM STEP # 1 + -

STATE STOPPED RUN TO STEP # 1 + -

PROGRESS 0% REPEAT TIMES Infinite + -

REPEAT TIMES COUNTER 0

CONFIGURATION SETTINGS

APPLY CANCEL

TRANSIENT TABLE

MODE STEP SEGMENT EDIT MODE CYCLE BASED TIME BASED

#	RAMP [ms]	DWELL [ms]	FREQ [Hz]	V _{AC} [V _{RMS}] A/B/C	V _{DC} [V] A/B/C	Waveform [#] A/B/C	Phase [Deg] A/B/C
> 1	100.0	100.0	60.00	0.00	0.00	1	0.00/120.00/240.00

APPLY CANCEL + ADD ROW - DELETE ROW CLEAR

PROGram:DEFine

```
FORM,3,COUPL,DIRECT,VOLT:MODE,2,CONFIG,0,RANG,0,FREQ,60.000,VOLT1,0.000,VOLT2,0.000,VOLT3,0.000,VOLT:ALC:STAT,1,CURR:OV,0,CURR:LIM1,130.000,CURR:LIM2,130.000,CURR:LIM3,130.000,IPROT:STAT,0,CURR:PROT:LEV,130.000,IPEAK:LIM,360.000,PHAS1,0.000,PHAS2,120.000,PHAS3,240.000,WAVEFORM1,1,WAVEFORM2,1,WAVEFORM3,1,VOLT:DC1,0.000,VOLT:DC2,0.000,VOLT:DC3,0.000,POW:LIM1,17.2500,POW:LIM2,17.2500,POW:LIM3,17.2500,KVA:LIM1,17.2500,KVA:LIM2,17.2500,KVA:LIM3,17.2500,PPROT:STAT,0,POW:PROT:LEV,17.2500,KVA:PROT:LEV,17.2500,PROT:TDELAY,5,FREQ:SLEW,5.000,VOLT:SLEW,10.000,VOLT:DC:SLEW,10.000,UPDATEPH,0.000,RAMP,0.0002,VPEAK:MARG,100.000,EVENTS,0,AUTORMS,1,STEP,1,FSTEP,60.00,VSTEP1,0.00,VSTEP2,0.00,VSTEP3,0.00,VDCSTEP1,0.00,VDCSTEP2,0.00,VDCSTEP3,0.00,PSTEP2,120.00,PSTEP3,240.00,WFSTEP1,1,WFSTEP2,1,WFSTEP3,1,RTSTEP,0.1000,DTSTEP,0.1000,LAST
```

Note: NSTEPS,1, PSTEP1,0.00 not included in program command.

PROGram:DEFine:ALL?

```
FORM,3,COUPL,DIRECT,VOLT:MODE,2,CONFIG,0,RANG,0,FREQ,60.000,VOLT1,0.000,VOLT2,0.000,VOLT3,0.000,VOLT:ALC:STAT,1,CURR:OV,0,CURR:LIM1,130.000,CURR:LIM2,130.000,CURR:LIM3,130.000,IPROT:STAT,0,CURR:PROT:LEV,130.000,IPEAK:LIM,360.000,PHAS1,0.000,PHAS2,120.000,PHAS3,240.000,WAVEFORM1,1,WAVEFORM2,1,WAVEFORM3,1,VOLT:DC1,0.000,VOLT:DC2,0.000,VOLT:DC3,0.000,POW:LIM1,17.2500,POW:LIM2,17.2500,POW:LIM3,17.2500,KVA:LIM1,17.2500,KVA:LIM2,17.2500,KVA:LIM3,17.2500,PPROT:STAT,0,POW:PROT:LEV,17.2500,KVA:PROT:LEV,17.2500,PROT:TDELAY,5,FREQ:SLEW,5.000,VOLT:SLEW,10.000,VOLT:DC:SLEW,10.000,UPDATEPH,0.000,RAMP,0.0002,VPEAK:MARG,100.000,EVENTS,0,AUTORMS,1,NSTEPS,1,STEP,1,FSTEP,60.00,VSTEP1,0.00,VSTEP2,0.00,VSTEP3,0.00,VDCSTEP1,0.00,VDCSTEP2,0.00,VDCSTEP3,0.00,PSTEP1,0.00,PSTEP2,120.00,PSTEP3,240.00,WFSTEP1,1,WFSTEP2,1,WFSTEP3,1,RTSTEP,0.1000,DTSTEP,0.1000,LAST
```

8.6.1.1 Steady State Output Parameter List Table

The following table details the available parameters for the steady state program definitions.

Parameter	Description
FORM,<n>	sets Output Power Form of selected program n = <1>Single Φ , <2>Split Φ , or <3>Three Φ
COUPLing,<s>	sets Output coupling of selected program s = <DIRECT> <0> or <XFMR> <1>
XFMRRatio,<n.nn>	sets Output XFMR ratio (n.nn:1) of selected program n.nn = <0.0100> to <5.1111>
FREQuency,<n>	sets Output Frequency of selected program n = <:SOUR:FREQ:LIM:MIN> to <:SOUR:FREQ:LIM:MAX> Hz
VOLTage,<n>	sets Output VOLTAGE Φ A,B,C of selected program n = <0> to <440 x XFMRRatio> Volts
VOLTage1,<n>	sets Output VOLTAGE Φ A of selected program n = <0> to <440 x XFMRRatio> Volts
VOLTage2,<n>	sets Output VOLTAGE Φ B of selected program n = <0> to <440 x XFMRRatio> Volts
VOLTage3,<n>	sets Output VOLTAGE Φ C of selected program n = <0> to <440 x XFMRRatio> Volts
CURRent:LIMit,<n>	sets Output Current Limit of selected program n = <0> to <AMPS meter range> Amps
CURRent:PROTect:LEVel,<n>	sets Output Current level that triggers Current Protect mode n = <0> to <AMPS meter range> Amps
CURRent:PROTect:TOUT,<n>	sets time that the Output Current must exceed the Current Protect level before Current Protect disables the power source output. n = <1> to <65535>, 1 = 100mSec.
PHASe2,<n>	sets Output Phase Angle B of selected program n = <0> to <359> degrees
PHASe3,<n>	sets Output Phase Angle C of selected program n = <0> to <359> degrees
WAVEFORM,<n>	sets Output Waveform Φ A, Φ B, Φ C of selected program n = <1> to <16>
WAVEFORM1,<n>	sets Output Waveform Φ A of selected program n = <1> to <16>
WAVEFORM2,<n>	sets Output Waveform Φ B of selected program n = <1> to <16>
WAVEFORM3,<n>	sets Output Waveform Φ C of selected program n = <1> to <16>
EVENTS,<n>	sets number of times to repeat the transient portion of the selected program when the Transient is executed n = 0-65535. A value of 0 specifies continuous operation
AUTORMS,<n>	program Transient Waveform Auto RMS mode (4.5.2) n = 0, use program steady-state waveform RMS factor n = 1, calculate RMS factor based on transient waveform
NSEGS,<n>	Command: Specifies the number of Transient segments (all parameters) to return in a subsequent :PROG:DEFine? query. If NSEGS is not specified, 1 segment is returned by :PROG:DEFine? EXAMPLE: :PROG:DEF SEG,3,NSEGS,4;PROG:DEF? will return 4 transient segments, starting with Segment 3. NOTE: The value will revert back to 1 after each query.

Parameter	Description
	Query: The NSEGS parameter of a :PROG:DEF? query returns total number of Transient segments defined in the selected program

8.6.1.2 Transient Segment Output Parameter List Table

The following table details the available parameters for the transient segment program definitions.

Parameters	Description
SEGment,<n>	Transient segment n of the selected program to be edited. Also the starting segment when querying multiple segments (see NSEGS) n = <1> to <100>
FSEG,<n>	sets objective Frequency of selected segment n = <:SOUR:FREQ:LIM:MIN> to <:SOUR:FREQ:LIM:MAX> Hz
VSEG,<n>	sets objective voltage Φ A, Φ B, Φ C of selected segment n = <0> to <440 x XFMRRTATIO> Volts
VSEG1,<n>	sets objective voltage Φ A of selected segment n = <0> to <440 x XFMRRTATIO> Volts
VSEG2,<n>	sets objective voltage Φ B of selected segment n = <0> to <440 x XFMRRTATIO> Volts
VSEG3,<n>	sets objective voltage Φ C of selected segment n = <0> to <440 x XFMRRTATIO> Volts
WFSEG,<n>	sets Waveform Φ A, Φ B, Φ C of selected segment n = <1> to <16>
WFSEG1,<n>	sets Waveform Φ A of selected segment n = <1> to <16>
WFSEG2,<n>	sets Waveform Φ B of selected segment n = <1> to <16>
WFSEG3,<n>	sets Waveform Φ C of selected segment n = <1> to <16>
TSEG,<n>	sets execution time (to reach objective Voltage and Frequency) of selected segment n = <0> or <0.0002> to <300> seconds. Setting n to <0> selects cycle-based transient operation, i.e., each segment time is equal to the period of 1 cycle (1/FREQ)
LAST	sets selected segment to be the last segment of selected transient

Command Syntax Description	<p>PROG:EXECuted:DEFine <cr></p> <p>This command programs all values stored in the selected program number. Both steady-state and transient segment parameter names and values may be sent. Program parameters are defined in the following sections.</p> <p>NOTE: Only commas may separate the values, NO Carriage Returns or Line Feeds may separate the values within a single command message.</p>
Parameters Parameter Format Example Query Format Returned Data Format Query Example	<p>Refer to PROG:SElected:DEFine command</p> <p><cr>,<cr>,<cr>,<cr>,<cr></p> <p>PROG:EXECuted:DEFine?</p> <p><cr>,<cr>,<cr>,<cr>,<cr></p> <p>PROG:EXEC:DEF?</p> <p>-> parameter list</p>
Query Format Description	<p>PROG[:SElected]:DEFine:ALL?</p> <p>This query returns the parameter list for the selected program number or name.</p>
Parameters	<p>Option: PROGRAM, NUMBER [,<cr>} or [,<nr1>]</p> <p>Option: MEMORY [,<cr>]– Available are: INTERNAL RAM USB</p> <p>Parameter list define string <cr>,<cr>,<cr>,<cr>,<cr></p>
Query Example	<p>PROG:DEF:ALL?</p> <p>-> parameter list</p>
Query Format Description	<p>PROG:EXECuted:DEFine:ALL?</p> <p>This query returns the parameter list for the executing program number or name.</p>
Parameters	<p>Option: PROGRAM, NUMBER [,<cr>} or [,<nr1>]</p> <p>Option: MEMORY [,<cr>]</p> <p>Parameter list define string <cr>,<cr>,<cr>,<cr>,<cr></p>
Query Example	<p>PROG:EXEC:DEF:ALL? 3</p> <p>-> parameter list</p>
Command Syntax Description	<p>PROG[:SElected]:INfOrmation <cr> [,<nr1>] [,<cr>]</p> <p>This command assigns program information data to the selected program.</p>
Parameters	<p>Information string <cr></p> <p>Option: PROGRAM NUMBER [,<nr1>]</p> <p>Option: MEMORY [,<cr>]– Available are: INTERNAL RAM USB</p>
Parameter Format Example Query Format Returned Data Format Query Example	<p><cr> [,<nr1>] [,<cr>]</p> <p>PROG:INfO 3, INTERNAL, SAMPLE TEST</p> <p>PROG[:SElected]:INfOrmation? [<nr1>] [,<cr>]</p> <p><cr></p> <p>PROG:INfO? 2, USB</p> <p>-> Program info string</p>

<p>Command Syntax Description</p> <p>Parameters</p> <p>Parameter Format Example</p> <p>Query Format Returned Data Format Query Example</p>	<p>PROGRAM:EXECuted:INfOrmatIOn <cr> [,<nr1>] [,<cr>]</p> <p>This command assigns program information data to the executing program.</p> <p>Information string <cr> Option: PROGRAM NUMBER [,<nr1>] Option: MEMORY [,<cr>]– Available are: INTERNAL RAM USB</p> <p><cr> [,<nr1>] [,<cr>] PROG:EXEC:INFO 3, INTERNAL, SAMPLE TEST</p> <p>PROGRAM:EXECuted:INfOrmatIOn? [,<nr1>] [,<cr>]</p> <p><cr> PROG:EXEC:INFO? 2, USB -> Program info string</p>
<p>Command Syntax Description</p> <p>Parameters</p> <p>Parameter Format Example</p> <p>Query Format Returned Data Format Query Example</p>	<p>PROGRAM[:SElected]:ALIAS <cr> [,<nr1>] [,<cr>]</p> <p>This command assigns a user provided alias string name to the selected program. Program number and memory type are optional parameters.</p> <p>Alias String <cr> Option: PROGRAM NUMBER [,<nr1>] Option: MEMORY [,<cr>]– Available are: INTERNAL RAM USB</p> <p><cr> [,<nr1>] [,<cr>] PROG:ALIAS TEST1</p> <p>PROGRAM[:SElected]:ALIAS? [,<nr1>] [,<cr>]</p> <p><cr> PROG:ALIAS? TEST1</p>
<p>Command Syntax Description</p> <p>Parameters</p> <p>Parameter Format Example</p> <p>Query Format Returned Data Format Query Example</p>	<p>PROGRAM:EXECuted:ALIAS <cr> [,<nr1>] [,<cr>]</p> <p>This command assigns a user provided alias string name to the executing program. Program number and memory type are optional parameters.</p> <p>Alias String <cr> Option: PROGRAM NUMBER [,<nr1>] Option: MEMORY [,<cr>]– Available are: INTERNAL RAM USB</p> <p><cr> [,<nr1>] [,<cr>] PROG:EXEC:ALIAS TEST2</p> <p>PROGRAM:EXECuted:ALIAS? [,<nr1>] [,<cr>]</p> <p><cr> PROG:EXEC:ALIAS? TEST2</p>

Query Format	PROGram[:SELEcted]:SST? [,<nr1>] [,<cr>]
Description	This command returns the Steady State Table settings of the selected program only. The transient table data is not returned.
Parameters	Option: PROGRAM NUMBER [,<nr1>] Option: MEMORY [,<cr>]– Available are: INTERNAL RAM USB
Returned Data Format	<cr>
Query Example	PROG:SST? 2, USB -> steady state table program data
Query Format	PROGram:EXECuted:SST? [,<nr1>] [,<cr>]
Description	This command returns the Steady State Table settings of the executing program only. The transient table data is not returned.
Parameters	Option: PROGRAM NUMBER [,<nr1>] Option: MEMORY [,<cr>]– Available are: INTERNAL RAM USB
Returned Data Format	<cr>
Query Example	PROG:EXEC:SST? -> steady state table program data

Query Format	PROG:EXECuted:TT? [,<nr1>] [,<cr>]
Description	This command returns the Transient Table settings of the executing program only. The steady state table data is not returned.
Parameters	Option: STYLE [,<nr1> 0 = Human readable Style A (default if omitted) 1 = Human readable Style B 2 = Binary Data Format. Can be more useful to search for differences between programs. See PROG:TT? Command for formats
Returned Data Format	Option: PROGRAM NUMBER [,<nr1> Option: MEMORY [,<cr>]– Available are: INTERNAL RAM USB <cr>
Query Example	PROG:EXEC:TT? 2 -> transient table program data
Query Format	PROG:[SE]lected:CHECK? [,<nr1>] [,<cr>]
Description	This command performs a check on the selected program steady state and transient tables looking for the following conditions: <ul style="list-style-type: none"> • Hardware Limit violations • User Limit violations • Saturation limits. <p>If no violations are present, this command returns OK and the program can be executed without generating any errors. If the selected program cannot be run due to one or more issues with its content, one or more errors detailing the issues will be returned. For example, if the upper voltage user limit is set to 100V and the program contains a setting of 300V, a “Cannot load program, Run PROGRAM:CHECK?” error will be generated when attempting to execute this program. When sending the PROGRAM:CHECK? Query, the response will be “VOLT1 AC voltage set point cannot change due to user limit”.</p>
Parameters	Option: PROGRAM NUMBER [,<nr1> Option: MEMORY [,<cr>]– Available are: INTERNAL RAM USB
Returned Data Format	<cr>
Query Example	PROG:CHECK? VOLT1 AC voltage set point cannot change due to user limit
Query Format	PROG:EXECuted:CHECK? [,<nr1>] [,<cr>]
Description	This command serves the same purpose as the PROG:CHECK? Command but applies to a program that is executing.
Parameters	Option: PROGRAM NUMBER [,<nr1> Option: MEMORY [,<cr>]– Available are: INTERNAL RAM USB
Returned Data Format	<cr>
Query Example	PROG:EXEC:CHECK? VOLT1 AC voltage set point cannot change due to user limit

<p>Command Syntax Description</p> <p>Parameters Parameter Format Example</p>	<p>PROGram[:SElected]:DElete</p> <p>This command deletes the selected program. Attempting to DElete an EXECuting Program will result in an Error.</p> <p>Program number <nr1> PROG:DEL 9</p>
<p>Query Format Description</p> <p>Parameters</p> <p>Returned Data Format Decoding</p> <p>Query Example Example</p>	<p>PROGram[:SElected]:CHANges? <nr1>, <cr></p> <p>This command compares the program that is executing with another program stored in the memory type and location passed as parameters. The results of the comparison is returned as a decimal number ranging from 0 to 15 representing a four bit binary value. This result can be decoded as shown below.</p> <p>Option: PROGRAM NUMBER [,<nr1>] Option: MEMORY [,<cr>]– Available are: INTERNAL RAM USB</p> <p><nr>1</p> <p>Bit 0: If set to 1, there are differences in the steady state table (SST) Bit 1: If set to 1, there are differences in the transient table (TT) Bit 2: If set to 1, there are differences in the ALIAS of the program Bit 3: If set to 1, there are differences in INfOrmation of the program</p> <p>PROG:CHAN? 16</p> <p>If the query returns zero (0), the program executing is identical to the stored program referenced. If the command returns three (3), the program executing has differences with the referenced program in both the steady state table and the transient table.</p>
<p>Command Syntax Description</p> <p>Parameters</p> <p>Parameter Format Example</p>	<p>PROGram[:SElected]:COPY <nr1> [,<cr>]</p> <p>This command copies the selected program as previously specified by the PROG:NAME <nr1> command to destination program number. NOTE: The destination Program specified cannot be currently executing.</p> <p>DESTINATION PROGRAM NUMBER <nr1> Option: MEMORY [,<cr>]– Available are: INTERNAL RAM USB</p> <p><nr1>, [,<cr>] PROG:COPY 2, USB</p>
<p>Command Syntax Description</p> <p>Parameters</p> <p>Parameter Format Example</p>	<p>PROGram:EXECuted:COPY <nr1> [,<cr>]</p> <p>This command copies the executed program to destination program number.</p> <p>DESTINATION PROGRAM NUMBER <nr1> Option: MEMORY [,<cr>]– Available are: INTERNAL RAM USB</p> <p><nr1>, [,<cr>] PROG:EXEC:COPY 2, USB</p>

8.6.2 Execution Commands

The following commands may be used to control stored program executions.

Command Syntax	PROG ram[:SElected]:EXECute [<nr1> [,<cr>]
Description	This command executes the selected program (default) or the program number passed as the first parameter.
Parameters	Option: PROGRAM NUMBER [,<nr1>] Option: MEMORY [,<cr>]– Available are: INTERNAL RAM USB
Parameter Format	[<nr1> [,<cr>]
Example	PROG:EXEC 2
Query Format	PROG ram[:SElected]:EXECute ?
Description	The query format returns the number of the program that is in effect.
Parameter Format	<nr1>
Example	PROG:EXEC? 23
Command Syntax	PROG ram:EXECute:TRANS [<nr1> [,<cr>]
Description	This command executes the selected program’s (default) transient table or the program number passed as the first parameter.
Parameters	Option: PROGRAM NUMBER [,<nr1>] Option: MEMORY [,<cr>]– Available are: INTERNAL RAM USB
Parameter Format	[<nr1> [,<cr>]
Example	PROG:EXEC:TRANS 2
Command Syntax	PROG ram:EXECute:TRANS:RESET
Description	This command serves the same purpose as the “PROG
	ram:TRANSient STOP” command. See next.
	This command resets the active transient execution. This command is included to support UPC compatibility mode although it is not documented in the UPC manual. Not recommended for new programs.
Parameters	None
Parameter Format	n/a
Example	PROG:EXEC:TRANS:RESET

8.6.3 Transient Segments Commands

The following commands may be used to control stored transient program executions.

Command Syntax	PROG:TRANSient
Description	This command controls transient execution
Parameters	RUN STOP PAUSE STEP REStart
Parameter Format	<cr>
Example	PROG:TRAN RUN
Query Format	PROG:TRANSient?
Description	Query format returns the transient execution state as either RUN, STOP, PAUS, STEP or REST
Returned Data Format	<cr>
Query Example	PROG:TRAN? RUN
Command Syntax	PROG:TRANSient:AUTORMS <BOOLEAN>
Description	If enabled, the value of any waveform used in a transient segment is normalized in order to match the RMS set point. If disabled, the waveform is reproduced without any normalization. This function is useful for waveform substitution at the steady state level. Note: This function is related to the AUTORMS function in the steady state segment.
Parameters	[0 OFF 1 ON]
Parameter Format	
Example	PROG:TRAN:AUTORMS 1
Query Format	PROG:TRANSient:AUTORMS?
Returned Data Format	
Query Example	PROG:TRAN:AUTORMS? 1
Command Syntax	PROG:TRANSient:CR <BOOLEAN>
Description	This command enables or disables the Cycle Reset mode during transient execution. When on, Cycle Reset will resync each transient run in repeat mode to the start phase angle.
Parameters	[0 OFF 1 ON]
Parameter Format	
Example	PROG:TRAN:CR 1
Query Format	PROG:TRANSient:CR?
Returned Data Format	<nr1>
Query Example	PROG:TRAN:CR? 0

Command Syntax	PROG:TRANsient:HOLD <ON OFF>
Description	This commands turns the Transient HOLD mode on or off. If ON, the power source holds the last segment values at steady state after the transient ends. If OFF, the output of the power source returns to the steady state settings in effect before the transient segment ran.
Parameters	[0 OFF 1 ON]
Parameter Format	<cr>
Example	PROG:TRAN:HOLD ON
Query Format	PROG:TRANsient:HOLD?
Returned Data Format	
Query Example	PROG:TRAN:MODE? 1

Query Format
Description

PROG:TRAN:PROG?

This command returns the progress status of a running transient. The response data content depends on the selected transient mode, SEGMENT or STEP. (Refer to the "PROG:TRAN:MODE" command)
The following information is returned in the order shown below. Values are separated by a "/" character:

Return Data Format

- A. Progress as a percent of the total between 0 to 100.
- B. Current element progress. A percent between 0 and 100 of the element executing.
- C. Active step or segment in execution.
- D. Active step or segment time. In multiples of 0.2 ms.
- E. Total time. In multiples of 0.2 ms.
- F. Total number of steps or segments.

Returned Data Format
Query Example

<nr1> / <nr1> / <nr1> / <nr1> / <nr1> / <nr1>
PROG:TRAN:PROG?
57/31/3/1554/20000/4

TRANSIENT TABLE						
TRANSIENT MODE						
STEP SEGMENT						
#	TIME [ms]	FREQ [Hz]	V _{AC} [V _{RMS}] A/B/C	V _{OC} [V] A/B/C	Phase [deg] B/C	
> 1	1000.0	60.00	0.00	0.00	120.00/240.0	
> 2	1000.0	60.00	0.00	0.00	120.00/240.0	
> 3	1000.0	60.00	0.00	0.00	120.00/240.0	
> 4	1000.0	60.00	0.00	0.00	120.00/240.0	

Example

Return data for transient table shown above in STEP mode would be

57/31/3/1554/20000/4

- A. Progress = 57% of total time or 0.57 * 4000 ms = 2280 ms
- B. Current element progress = 31% or 0.31 * 1000 ms = 310 ms
- C. Active step = 3
- D. Active step time = 1554 * 0.2 ms = 310.8 ms
- E. Total time = 20000 * 0.2 ms = 4000 ms
- F. Total number of steps = 4.

Relationship between data fields

$$A = (((\text{Summing of the element times between 1 and C-1}) / 0.2 + D) / E) * 100$$

For the example $A = ((1000+1000)/0.2+1554)/20000 = 57\%$

$$B = (D / (\text{Time of the element C} / 0.2)) * 100$$

For the example $B = (1554/(1000/0.2))*100 = 31\%$

<p>Query Format Description</p>	<p>PROG:TRANSient:EIE?</p> <p>This query command returns the active Element In Execution. An element is either a STEP when in transient STEP mode or a SEGMENT when in transient SEGMENT mode.</p> <p>Note: the data returned on this query is the same as the “C” data returned by the “PROG:TRANSient:PROGress?” command.</p>
<p>Returned Data Format Query Example</p>	<p><nr1> PROG:TRAN:EIE? 3</p>
<p>Query Format Description</p>	<p>PROG:TRANSient:ETE?</p> <p>This query command returns the active Element To Execute. An element is either a STEP when in transient STEP mode or a SEGMENT when in transient SEGMENT mode.</p> <p>The ETE query is useful when a transient execution has been PAUSED by the “PROG:TRANSient PAUSE” command. For example, if the execution is paused in the middle of an element (step or segment) execution for element “n”, the ETE value will be “n”. If it is paused at the end of element “n”, the ETE value will be “n+1”.</p>
<p>Returned Data Format Query Example</p>	<p><nr1> PROG:TRAN:ETE? 4</p>
<p>Command Syntax Description</p>	<p>PROG:TRANSient:MODE</p> <p>This command selects between legacy UPC controller mode SEGMENT transient mode or STEP mode. Segment mode is backward compatible with PPS UPC controllers and use a steady state table and a transient table for each segment. A total of 99 segments can be programmed. STEP mode uses the conventional SCPI LIST system of a list of transient steps executed sequentially.</p>
<p>Parameters Parameter Format Example Query Format Returned Data Format Query Example</p>	<p>[0 SEGMENT 1 STEP] <cr> PROG:TRAN:MODE STEP PROG:TRANSient:MODE? <nr1> PROG:TRAN:MODE? 1</p>

<p>Command Syntax Description</p>	<p>PROG:TRANSient:CSC</p> <p>This command turns the CSC Mode during transient execution on (1) or off (0). This allows load regulation adjustment during transient execution. However, keep in mind that CSC adjustments are based on RMS voltage measurement, which take several cycles to run so turning on CSC on fast changing voltage transients is not recommended as the CSC may interfere with the programmed transient voltages.</p> <p>Note 1: In UPC compatibility mode, the CSC is always off during transient execution regardless of this setting to match the UPC controller operation.</p>
<p>Parameters Parameter Format Example Query Format Returned Data Format Query Example</p>	<p>< 0 OFF 1 ON ></p> <p><cr></p> <p>PROG:TRAN:CSC ON</p> <p>PROG:TRANSient:CSC?</p> <p><cr></p> <p>PROG:TRAN:CSC?</p> <p>1</p>
<p>Command Syntax Description</p>	<p>PROG:TRANSient:FROM</p> <p>This command sets the first transient step number at which step mode execution is to begin. The step specified must exist or an error message will be generated.</p>
<p>Parameters Parameter Format Example Query Format Returned Data Format Query Example</p>	<p>STEP number from 1 ~ 99</p> <p><nr1></p> <p>PROG:TRAN:FROM 5</p> <p>PROG:TRANSient:FROM?</p> <p><nr1></p> <p>PROG:TRAN:FROM?</p> <p>5</p>
<p>Command Syntax Description</p>	<p>PROG:TRANSient:TO</p> <p>This command sets the transient step number at which step mode execution is to end. The step specified must exist or an error message will be generated.</p>
<p>Parameters Parameter Format Example Query Format Returned Data Format Query Example</p>	<p>STEP number from 1 ~ 99</p> <p><nr1></p> <p>PROG:TRAN:TO 25</p> <p>PROG:TRANSient:TO?</p> <p><nr1></p> <p>PROG:TRAN:TO?</p> <p>25</p>

Command Syntax
Description

PROG:TRANsient:TRANSition:MODE

This command sets the transient mode to one of three available modes:

0. **RTC UPC Mode**, immediate transition (straight line). Any ramp determined by power amplifier slew rate.
1. **UPC Step Mode** transition after 100 µsec + 100 µsec delay (backward compatible with legacy UPC controllers)
2. **RAMP** or **SLEW** transition.

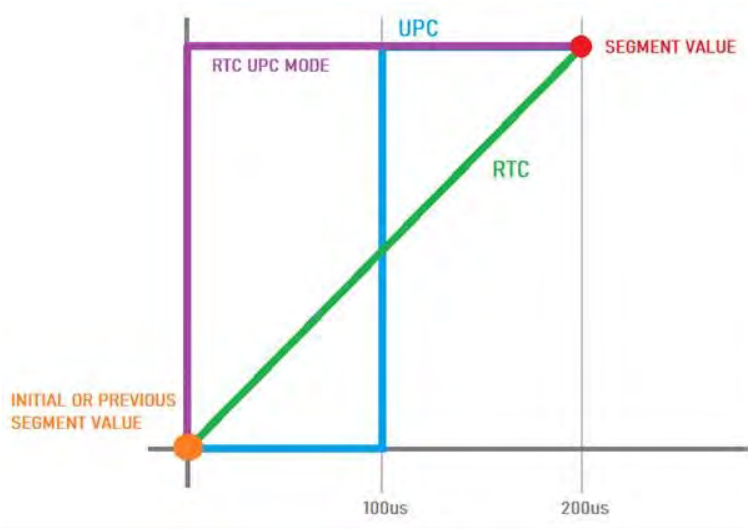

Parameters
Parameter Format
Example
Query Format
Query Example

0, 1 or 2
<nr1>
PROG:TRAN:TRANS:MODE 1
PROG:TRANsient:TRANSition:MODE?
PROG:TRAN:TRAN:MODE?
1

Query Syntax
Description

PROG:TRANsient:TRANSition:MODE:CATalog?

This command returns the available transient transition mode settings.

Returned Data Format
Query Example

<nr1>
PROG:TRAN:TRAN:MODE:CAT?
0, Straight line, 1, Step, 2, Ramp or slew

Command Syntax	PROG:TRANsient:EVENTs <nr1>
Description	This command sets the number of repetitions for executing the selected transient. A zero value is equivalent to infinite execution until aborted by "PROG:TRAN STOP" command.
Parameters	Repetition, range is 0 ~ 99999
Parameter Format	<nr1>
Example	PROG:TRAN:EVEN 5
Query Format	PROG:TRANsient:EVENTs?
Returned Data Format	<nr1>
Query Example	PROG:TRAN:EVEN? 5
Command Syntax	PROG:TRANsient:GOTO <nr1>
Description	This command forces transient execution to move to the element argument passed (STEP in STEP mode or SEGMENT in segment mode).
Parameters	ELEMENT
Parameter Format	<nr1>
Example	PROG:TRAN:GOTO 3

8.6.4 Memory Management Commands

The Program memory subsystem commands allow management of Program memory contents.

Command Syntax	PROG:MEMory <cr>
Description	This command selects the specific program memory type for storing and retrieving programs. Default is INTERNAL memory. Alternatives are RAM and USB devices. The memory type can also be specified as an optional parameter with several PROG:MEM commands where indicated in this manual.
Parameters	Memory types: INTERNAL RAM USB. For a complete list of available memory types, use the "PROG:MEMory:CATalog?" Command.
Parameter Format	<cr>
Example	PROG:MEM USB
Query Format	PROG:MEMory?
Returned Data Format	<cr>
Query Example	PROG:MEM? USB
Query Format	PROG:MEMory:CATalog?
Description	This query command returns a comma separated list of available memory types that can be selected for storage of steady state and transient table information.
Returned Data Format	INTERNAL, RAM, SD1, SD2, SD3, USB
Memory Types	INTERNAL = Internal Flash Memory. (Default selection) RAM = Internal RAM. Content will be lost when power source is turned off. USB[X][Y] = USB memory stick devices. X = port number, Y = partition number SD[Y] = SC Card, Y = partition number X = symbolizes different memory sticks connected to various available USB ports. Y = symbolizes different logical partitions on a USB memory stick or SD card. INTERNAL and RAM are always available. INTERNAL is default selection. Use the "PROG:MEMory <cr>" command to select active memory selection.
Query Example	PROG:MEM:CAT? INTERNAL,RAM,USBA1

<p>Query Format Description</p> <p>Parameters Parameter Format Example Query Format Returned Data Format Query Example</p>	<p>PROG:EXECuted:MEMory?</p> <p>This command selects the specific program memory type for storing and retrieving programs. Default is INTERNAL memory. Alternatives are RAM and USB devices. The memory type can also be specified as an optional parameter with several PROG:EXEC commands where indicated in this manual.</p> <p>Memory types: INTERNAL RAM USB</p> <p><cr></p> <p>PROG:EXEC:MEM USB</p> <p>PROG:EXECuted:MEMory?</p> <p><cr></p> <p>PROG:EXEC:MEM? USB</p>
<p>Command Syntax Description</p> <p>Parameters Parameter Format Example Query Format Returned Data Format Query Example</p>	<p>PROG:POWOn <nr1></p> <p>Returns the number of the stored program that will be recalled at power on.</p> <p>Program number</p> <p><nr1></p> <p>PROG:POWO 1</p> <p>PROG:POWOn?</p> <p><nr1></p> <p>PROG:POWO? 1</p>
<p>Command Syntax Description</p> <p>Parameters Parameter Format Example</p>	<p>PROG:DELeTe:ALL <cr></p> <p>This command deletes all programs, waveforms and setup values, performs device RESET, loads Program #1 with *RST default values, executes MANUAL MODE with *RST values. Waveforms (1-16) are re-loaded from internal Flash memory. Attempting to DELeTe an EXECuting Program will result in an error message.</p> <p>Optional: Memory type: INTERNAL RAM USB</p> <p><cr></p> <p>PROG:DEL:ALL USB</p>
<p>Query Format Description</p> <p>Parameters Parameter Format Returned Data Format Query Example</p>	<p>PROG:CATalog? <cr></p> <p>This query returns a comma separated list of <nr1> values representing stored programs (e.g. 1,2,7...). If the MANUAL MODE program setup exists, the list will include 0. If no programs are stored at all, this query returns a 1</p> <p>Optional: Memory type: INTERNAL RAM USB</p> <p><cr></p> <p><nr1>,<nr1>,...,<nr1>,<nr1></p> <p>PROG:CAT? 0,1,2,9,12 PROG:CAT? INTERNAL 0</p>

<p>Query Format</p> <p>Description</p> <p>Parameters</p> <p>Parameter Format</p> <p>Returned Data Format</p> <p>Query Example</p>	<p>PROGram:CRC? <cr></p> <p>This query command calculates and returns the checksum value of the selected program. This CRC may be used to verify the program data integrity is intact. This command is provided for UPC compatibility mode and not recommended for new programs.</p> <p>Optional: Memory type: INTERNAL RAM USB</p> <p><cr></p> <p><nr1></p> <p>PROG:CRC? RAM</p> <p>08ad55</p>
<p>Query Format</p> <p>Description</p> <p>Parameters</p> <p>Parameter Format</p> <p>Returned Data Format</p> <p>Query Example</p>	<p>PROGram:BROWse?</p> <p>This command returns the list of available programs stored in the memory selected or passed as a parameter.</p> <p>Optional: Memory type: INTERNAL RAM USB</p> <p><cr></p> <p><nr1>, <nr1>,.....,<nr1></p> <p>PROG:BROW?</p> <p>1,8,9,23</p>
<p>Query Format</p> <p>Description</p> <p>Returned Data Format</p> <p>Query Example</p>	<p>PROGram:WFBANK?</p> <p>This query command returns the waveform bank number. It is provided for UPC compatibility mode and not recommended for new programs. It always returns a minus one (-1) response.</p> <p>-1</p> <p>PROG:WFBANK?</p> <p>-1</p>
<p>Query Format</p> <p>Description</p> <p>Returned Data Format</p> <p>Query Example</p>	<p>PROGram:WFCRC?</p> <p>This query command calculates and returns the checksum value of all waveforms. The CRC may be used to verify the waveform data integrity is intact. This command is provided for UPC compatibility mode and not recommended for new programs.</p> <p><nr1></p> <p>PROG:WFCRC?</p> <p>-31893,18622,25404,-20201,15032,-2662,-28577,-5178,-3736,-23017,-19989,-25093,-2813,3096,-32131,4403</p>

8.7 Voltage Source Commands

Source commands control the settings of the power source. This includes all operating modes, voltages, frequency, current and power limits and phase angles as well as transient operation. Since the SOURCE subsystem is the primary system, the SOURce portion of these commands is optional. The following status commands are supported broken down by SOURCE sub groups.

8.7.1 Source Configuration Programming Commands

Command Syntax	[SOURce:]CONFIG
Description	Selects alternative loop compensation mode for improved transient response. The effect of this command depends on the selected output mode as follows: AC Mode: Changes the AC loop compensation DC Mode: Changes the DC loop compensation AC+DC Mode: Changes both the AC and DC loop compensations Note: The alternative compensation configuration setting is saved separately saved for DC and AC (only and +DC). When changed to off while in DC mode, it will be saved as off for DC only. Also if you are in AC only (or AC+DC) and you change it to 1, it is saved separately.
Parameters	< 0 1 > (0 = Normal loop, 1 = Faster Loop)
Parameter Format	
Example	SOUR:CONFIG 1
Query Format	[SOURce:]CONFIG?
Returned Data Format	
Query Example	CONFIG? 0
Command Syntax	[SOURce:]CONFIG:AC
Description	Selects alternative AC loop compensation mode for improved AC transient response. The effect of this command depends on the selected output mode as follows: AC Mode: Changes the AC loop compensation DC Mode: No effect AC+DC Mode: Changes the AC loop compensations
Parameters	< 0 1 > (0 = Normal loop, 1 = Faster Loop)
Parameter Format	
Example	SOUR:CONFIG:AC 1
Query Format	[SOURce:]CONFIG:AC?
Returned Data Format	
Query Example	CONFIG:AC? 0

<p>Command Syntax Description</p>	<p>[SOURCE:]CONFIG:DC </p> <p>Selects alternative DC loop compensation mode for improved DC transient response.</p> <p>The effect of this command depends on the selected output mode as follows:</p> <p>AC Mode: No effect DC Mode: Changes the DC loop compensation AC+DC Mode: No effect</p>
<p>Parameters Parameter Format Example Query Format Returned Data Format Query Example</p>	<p>< 0 1 > (0 = Normal loop, 1 = Faster Loop)</p> <p></p> <p>SOUR:CONFIG:DC 1</p> <p>[SOURCE:]CONFIG:DC?</p> <p></p> <p>CONFIG:DC?</p> <p>0</p>
<p>Command Syntax Description</p>	<p>[SOURCE:]CONFIG:HFreq </p> <p>This command enables high-frequency output current protection extension mode. In this mode, the protection for high frequency content at the output of the power source is held off for up to 2 seconds to allow short time events to ride through without tripping the normal protection mode.</p>
<p>Parameters Parameter Format Example Query Format Returned Data Format Query Example</p>	<p>< 0 OFF 1 ON > (0 = Off, 1 = On)</p> <p></p> <p>SOUR:CONFIG:HF 1</p> <p>[SOURCE:]CONFIG:HFreq?</p> <p></p> <p>CONFIG:HF?</p> <p>1</p>

Command Syntax	[SOURce:]COUPLing <cr>
Description	<p>Selects the output coupling mode. On AZX Series®, this command only accepts DIRECT as a setting unless the optional output transformer is connected and configured. The output voltage ratio of the transformer can be queried using the “SYSTem:XFMR RATIO?” command. The output voltage range is 440Vac x Ratio full scale Line to Neutral.</p> <p>If no transformer option is installed and configured, selecting XMFR coupling will generate a 2019 Error code. Do not select XMFR coupling if the SYSTem:XFMR RATIO? query returns a 0.0000 value.</p>
Parameters	<p>< DIRECT 0 XMFR 1 ></p> <p>0 = DIRECT</p> <p>1 = XMFR</p>
Parameter Format	<cr>
Example	COUPL DIRECT
Query Format	[SOURce:]COUPLing?
Returned Data Format	<cr>
Query Example	COUPL? 0

Command Syntax	[SOURce:]INITial <n>
Description	Sets source output settings initialization mode. This command in combination with the "OUTPut[:STATE]:AUTO" command allows the unattended resumption of a test station after a power failure. Note: This condition is potentially hazardous and should be used with caution.
[SOURce:]INITial? = ON	Set points of the unit at power on will be the last set after power off. The set points affected by this command are: - Frequency - Voltage AC1 - Voltage AC2 - Voltage AC3 - Voltage DC1 - Voltage DC2 - Voltage DC3 - Form (THREE , SPLIT or SINGLE) - Range (High or Low) - Compatibility Mode (UPC or NORMAL)
[SOURce:]INITial? = OFF	Set points of the unit at power on will have a default value of: - Frequency = 60Hz - Voltage AC1 = 0V - Voltage AC2 = 0V - Voltage AC3 = 0V - Voltage DC1 = 0V - Voltage DC2 = 0V - Voltage DC3 = 0V - Form = THREE - Range = HIGH - Compatibility = NORMAL
Parameters	< 0 OFF 1 ON >
Parameter Format	
Example	:INIT ON
Query Format	[SOURce:]INITial?
Returned Data Format	
Query Example	INIT? 0
Command Syntax	[SOURce:]FORM <nr1>
Description	Set phase mode or FORM. Allowable arguments are 1, 2 or 3.
Parameters	< 1 2 3 >
Parameter Format	<nr1>
Example	FORM 3
Query Format	[SOURce:]FORM?
Returned Data Format	<nr1>
Query Example	FORM? 3

<p>Command Syntax Description</p>	<p>[SOURCE:]RANGe Selects high or low voltage range. Although the AZX Series® has only a single voltage range, this commands allows simulation of a dual range AC voltage source which is more familiar to some users. Despite this virtual low range capability, no actual physical range change takes place so the output is never interrupted. Note: When switching from HIGH to LOW range, the output voltage may be reduced to the highest available voltage on the low range.</p>
<p>Parameters Parameter Format Example Query Format Returned Data Format Query Example</p>	<p>< 0 LOW 1 HIGH > RANG HIGH [SOURCE:]RANGe? RANG? 1</p>
<p>Command Syntax Description</p>	<p>[SOURCE:]RAMP# Sets voltage slew rate for selected phase number or for all phases if no phase number is specified.</p>
<p>Parameters Parameter Format Example Query Format Description Returned Data Format Query Example</p>	<p>Slew rate <nr2> SOUR:RAMP3 10.5 [SOURCE:]RAMP#? Returns voltage slew rate setting for specified phase (1, 2 or 3) or for phase 1 (A) if no phase number is specified. SOUR:RAMP3? 10.5000</p>
<p>Command Syntax Description</p>	<p>[SOURCE:]UPDATEPHase Set the phase angle at which programmed voltage changes on phase A will take place. This applies to output on and off phase angle placement as well. Available range is from 0° through 360.0° inclusive. Values higher than 360.0° will be truncated to 360.0000° automatically.</p>
<p>Parameters Parameter Format Example Query Format Returned Data Format Query Example</p>	<p>< 0.0000 - 360.0000 > <nr2> UPDATEPH 90.00 [SOURCE:]UPDATEPHase? <nr2> SOURce:UPDATEPH? 90.0000</p>

8.7.2 Voltage Programming Commands

Note that most of the voltage programming commands are phase specific so in three or split phase mode, each phase voltage can be individually programmed. This is done by appending 1, 2 or 3 for the “#” symbol shown in the syntax below. If the “#” value is omitted, all available phase (1, 2 or 3 in single, split or three phase mode respectively) will be set to the same amplitude. This allows the same program code to be used for any phase mode as long as the phase amplitudes need to be balanced.

The following command sets each phase to a different amplitude when in three phase mode.

```
SOUR:VOLT:AC1 15;;SOUR:VOLT:AC2 30;;SOURCE:VOLT:AC3 45
```

This command sets all phases to the same amplitude, regardless of phase mode:

```
SOUR:VOLT:AC 100
```

The query format for these phase specific commands will return the value for the phase number appended to the command. If the phase number reference is omitted, the setting for phase 1 (A) is returned.

Command Syntax	[SOURCE:]VOLTage:MODE
Description	Results voltage mode as 0 for AC, 1 for DC or 2 for ACDC. Note: In UPC compatibility mode, only AC mode is available
Parameters	< 0 AC 1 DC 2 ACDC >
Parameter Format	<nr1>
Example	VOLT:MODE DC
Query Format	[SOURCE:]VOLTage:MODE?
Returned Data Format	<nr1>
Query Example	VOLT:MODE? 1
Command Syntax	[SOURCE:]VOLTage:CSC[:STATE#] [SOURCE:]CSC:STATE#
Description	Turns the Continuous Source Calibration (CSC) mode on or off.
Parameters	<0 OFF 1 ON>
Parameter Format	
Example	VOLT:CSC ON
Query Format	[SOURCE:]VOLTage:CSC[:STATE]?
Returned Data Format	<nr1>
Query Example	VOLT:CSC? 1

8.7.2.1 Source Voltage Steady State Commands

Command Syntax	[SOURCE:]VOLTage[:AC]#
Description	Sets AC voltage for phase #. If # is omitted, sets all available phases to value specified.
Parameters	Range 0.0000 - 440.0000
Parameter Format	<nr2>
Example	VOLT:AC1 100.00
Query Format	[SOURCE:]VOLTage[:AC]#?
Description	Returns voltage setting for specified phase. If phase is omitted, returns voltage setting for phase A.
Returned Data Format	<nr2>
Query Example	VOLT:AC1? 100.0000
Command Syntax	[SOURCE:]VOLTage[:AC]#:SLEW
Description	Sets AC voltage slew rate for phase # in Volts per msec. If # is omitted, sets phase A slew rate to value specified.
Parameters	Range 0.01 – 300.0
Parameter Format	<nr2> and <nr3>
Example	VOLT:AC1:SLEW 300.00
Query Format	[SOURCE:]VOLTage[:AC]#:SLEW?
Description	Returns voltage slew rate setting for specified phase. If phase is omitted, returns voltage setting for phase A.
Returned Data Format	<nr2>
Query Example	VOLT:AC1:SLEW? 300.0000
Query Syntax	[SOURCE:]VOLTage[:AC]#:SLEW:MINimum?
Description	Returns the minimum set value for the AC voltage slew rate for phase # or all phases if omitted in Volts per msec.
Returned Data Format	<nr2>
Example	VOLT:AC:SLEW:MIN? 0.010
Query Syntax	[SOURCE:]VOLTage[:AC]#:SLEW:MAXimum?
Description	Returns the maximum set value for the AC voltage slew rate for phase # or all phases if omitted in Volts per msec.
Returned Data Format	<nr2>
Example	VOLT:AC:SLEW:MAX? 1500.000

Query Syntax	[SOURCE:]VOLTage[:AC]#:SLEW:DEFault?
Description	Returns the default set value for the AC voltage slew rate for phase # or all phases if omitted in Volts per msec.
Returned Data Format	<nr2>
Example	VOLT:AC:SLEW:DEF? 10.000
Command Syntax	[SOURCE:]VOLTage[:AC]:LIMit:MINimum
Description	Sets low user limit for AC voltage programming. User limits must fall within actual hardware limits of the power source. Also, MIN limit must be less than MAX limit.
Parameters	0.000 – 440.000
Parameter Format	<nr2>
Example	VOLT:LIM:MIN 20.0
Query Format	[SOURCE:]VOLTage[:AC]#:LIMit:MINimum?
Returned Data Format	<nr2>
Query Example	VOLT:LIM:MIN? 20.0000
Command Syntax	[SOURCE:]VOLTage[:AC]:LIMit:MAXimum
Description	Sets high user limit for AC voltage programming. User limits must fall within actual hardware limits of the power source. Also, MAX limit must be greater than MIN limit.
Parameters	0.000 – 440.000
Parameter Format	<nr2>
Example	VOLT:LIM:MAX 240.0
Query Format	[SOURCE:]VOLTage[:AC]#:LIMit:MAXimum?
Returned Data Format	<nr2>
Query Example	VOLT:LIM:MAX? 240.0000
Query Format	[SOURCE:]VOLTage[:AC]#:LIMit:RANGe?
Description	Returns available AC voltage range low and high limits.
Returned Data Format	<nr2>,<nr2>
Query Example	VOLT:AC1:LIM:RANG? 0.0000,440.0000

<p>Query Format Description</p>	<p>[SOURCE:]VOLTage[:AC]#:LIMIT:SATuration:RANGe? Returns the upper and lower limit sine wave RMS voltage at which saturation of the output inverter will occur. Saturation limits are determined in the maximum peak voltage capability of the AC+DC components at the output of the power source. For the AZX Series®, these limits are -425 and +425V. The VOLT:AC1:LIM:SAT:RANG? returns the min and max. RMS of a sine wave that may be programmed based on the programmed DC component. Maximum allowable values are: Maximum positive peak voltage: $V_peak_max = V_AC_peak_max + V_DC$ Minimum negative peak voltage: $V_peak_min = V_AC_peak_min + V_DC$ For a sinusoidal AC waveform, these limits are: $V_{rms_sat} = (650 - V_{dc}) / 1.4142$ $V_{rms_sat} = (-650 + V_{dc}) / 1.4142$</p>
<p>Returned Data Format Query Example</p>	<p><nr2> VOLT:AC3:LIM:SAT:RANG? 300.5204</p>
<p>Query Format Description</p>	<p>[SOURCE:]VOLTage[:AC]#:LIMIT:SATuration:MAXimum? Returns maximum sine wave RMS voltage at which saturation of the output inverter will occur. See [SOURCE:]VOLTage[:AC]#:LIMIT:SATuration:RANGe? for details.</p>
<p>Returned Data Format Query Example</p>	<p><nr2> VOLT:AC3:LIM:SAT:MAX? 301.154</p>
<p>Query Format Description</p>	<p>[SOURCE:]VOLTage[:AC]#:LIMIT:SATuration:MINimum? Returns minimum sine wave RMS voltage at which saturation of the output inverter will occur. See [SOURCE:]VOLTage[:AC]#:LIMIT:SATuration:RANGe? for details.</p>
<p>Returned Data Format Query Example</p>	<p><nr2> VOLT:AC3:LIM:SAT:MIN? 0.000</p>

Command Syntax Description	[SOURCE:]VOLTage[:AC]:INITial This command is equivalent to the “[SOURCE:]INITial <n>” command but applies only to the AC1, AC2 and AC3 parameters.
VOLT:INIT? = ON	Set points of the unit at power on will be the last set after power off. The set points affected by this command are: - Voltage AC1 - Voltage AC2 - Voltage AC3
VOLT:INIT? = OFF	Set points of the unit at power on will have a default value of: - Voltage AC1 = 0V - Voltage AC2 = 0V - Voltage AC3 = 0V
Parameters Parameter Format Example Query Format Returned Data Format Query Example	< 0 OFF 1 ON > VOLT:AC:INIT OFF [SOURCE:]VOLTage[:AC]:INITial? VOLT:AC:INIT? 0
Command Syntax Description	[SOURCE:]VOLTage:DC# Sets DC voltage for phase #. If # is omitted, sets all available phases to value specified. Note: Source must be in DC or AC+DC mode and UPC compatibility mode must be disabled.
Parameters Parameter Format Example Query Format Returned Data Format Query Example	Range 0.0000 - 425.0000 <nr2> VOLT:DC1 375.0 [SOURCE:]VOLTage:DC#? <nr2> VOLT:DC1? 375.0000
Command Syntax Description	[SOURCE:]VOLTage:DC#:SLEW Sets DC voltage slew rate for phase #. If # is omitted, sets all available phases to value specified. Note: Source must be in DC or AC+DC mode and UPC compatibility mode must be disabled.
Parameters Parameter Format Example Query Format Returned Data Format Query Example	Range 0.01- 850.00 <nr2> and <nr3> VOLT:DC1:SLEW 850.00 [SOURCE:]VOLTage:DC#:SLEW? <nr2> VOLT:DC1:SLEW? 850.0000

<p>Query Syntax Description</p> <p>Returned Data Format Example</p>	<p>[SOURCE:]VOLTage:DC#:SLEW:MINimum? Returns the minimum set value for the DC voltage slew rate for phase # or all phases if omitted in Volts per msec.</p> <p><nr2> VOLT:DC:SLEW:MIN? 0.010</p>
<p>Query Syntax Description</p> <p>Returned Data Format Example</p>	<p>[SOURCE:]VOLTage:DC#:SLEW:MAXimum? Returns the maximum set value for the DC voltage slew rate for phase # or all phases if omitted in Volts per msec.</p> <p><nr2> VOLT:DC:SLEW:MAX? 1500.000</p>
<p>Query Syntax Description</p> <p>Returned Data Format Example</p>	<p>[SOURCE:]VOLTage:DC#:SLEW:DEFault? Returns the default set value for the DC voltage slew rate for phase # or all phases if omitted in Volts per msec.</p> <p><nr2> VOLT:DC:SLEW:DEF? 10.000</p>
<p>Command Syntax Description</p> <p>Parameters Parameter Format Example Query Format Returned Data Format Query Example</p>	<p>[SOURCE:]VOLTage:DC#:LIMit:MINimum Sets low user limit for DC voltage programming for phase #. If # is omitted, sets all available phases to value specified. User limits must fall within actual hardware limits of the power source. Also, MIN limit must be less than MAX limit.</p> <p>-425.0 – 425.0 <nr2> VOLT:LIM:DC1:MIN 20.0</p> <p>[SOURCE:]VOLTage:DC#:LIMit:MINimum? <nr2> VOLT:DC1:LIM:MIN? -425.000</p>
<p>Command Syntax Description</p> <p>Parameters Parameter Format Example Query Format Returned Data Format Query Example</p>	<p>[SOURCE:]VOLTage:DC#:LIMit:MAXimum Sets upper user limit for DC voltage programming for phase #. If # is omitted, sets all available phases to value specified. User limits must fall within actual hardware limits of the power source. Also, MIN limit must be less than MAX limit.</p> <p>-425.0 – 425.0 <nr2> VOLT:LIM:DC1:MAX 270.0</p> <p>[SOURCE:]VOLTage:DC#:LIMit:MAXimum? <nr2> VOLT:DC1:LIM:MAX? -425.000</p>

<p>Query Format Description</p>	<p>[SOURCE:]VOLTage:DC#:LIMit:RANGe? This query returns both upper and lower user limits for DC voltage programming.</p>
<p>Returned Data Format Query Example</p>	<p><nr2>,<nr2> VOLT:DC1:LIM:RANG? -425.0000,425.0000</p>
<p>Query Format Description</p>	<p>[SOURCE:]VOLTage:DC#:LIMit:SATuration:RANGe? Returns maximum DC voltage at which saturation of the output inverter will occur. Saturation limits are determined in the maximum peak voltage capability of the AC+DC components at the output of the power source. For the AZX Series®, these limits are -425 and +425V. The VOLT:DC1:SAT? returns the max. DC level that may be programmed based on the programmed AC wave shape and RMS level. Maximum allowable values are: Maximum positive peak voltage: $V_DC = V_peak_max - V_AC_peak_max$ Minimum negative peak voltage: $V_DC = V_peak_min + V_AC_peak_min$</p>
<p>Returned Data Format Query Example</p>	<p><nr2> VOLT:DC1:LIM:SAT:RANG? -225, + 225</p>
<p>Query Format Description</p>	<p>[SOURCE:]VOLTage:DC#:LIMit:SATuration:MAXimum? Returns maximum sine wave RMS voltage at which saturation of the output inverter will occur. See [SOURCE:]VOLTage:DC#:LIMIT:SATuration:RANGe? for details.</p>
<p>Returned Data Format Query Example</p>	<p><nr2> VOLT:DC3:LIM:SAT:MAX? 254.946</p>
<p>Query Format Description</p>	<p>[SOURCE:]VOLTage:DC#:LIMit:SATuration:MINimum? Returns minimum sine wave RMS voltage at which saturation of the output inverter will occur. See [SOURCE:]VOLTage:DC#:LIMIT:SATuration:RANGe? for details.</p>
<p>Returned Data Format Query Example</p>	<p><nr2> VOLT:DC3:LIM:SAT:MIN? -254.946</p>

Command Syntax	[SOURCE:]VOLTage:EXTend
Description	This command grants access to a higher voltage range extension mode. When enabled, AC voltage settings up to 333V L-N are supported.
Parameters	[0 OFF 1 2] 0 = Off, 312Vac max. 1 = 320Vac max 2 = 333Vac max
Parameter Format	<bool>
Example	VOLT:EXT 1
Query Format	[SOURCE:]VOLTage:EXTend?
Returned Data Format	<nr1>
Query Example	VOLT:EXT? 1

8.7.2.2 Source Voltage Deviation Commands

Deviation commands allow certain output settings to be modified based on other parameters than voltage itself. This allows simulation of dependencies that may exist in power systems. Deviation settings are available for AC voltage, DC voltage, Frequency and Phase.

Each setpoint can be simultaneously affected by 3 different variables. The formula to calculate the deviation is:

$$\begin{aligned} \text{VALUE} = & \text{SETPOINT} + (\text{VARIABLE}_1 - \text{CENTER}_1) * \text{FACTOR}_1 \\ & + (\text{VARIABLE}_2 - \text{CENTER}_2) * \text{FACTOR}_2 \\ & + (\text{VARIABLE}_3 - \text{CENTER}_3) * \text{FACTOR}_3 \end{aligned}$$

DC References

In this section, only the AC commands are shown but each setpoint is configurable depending on the mode of operation of the unit. Below is an example of the relationship between them: (the same occurs for all parameters, factor, variable, center, slew rate, range).

AC commands:

[SOURCE:]VOLTage[:AC]#:DEVIation:FACTOR
 [SOURCE:]CURRent[:AC]#:DEVIation:FACTOR
 LOAD:CR:RESistance:AC#:DEVIation:FACTOR
 LOAD:CR:CONductance:AC#:DEVIation:FACTOR
 LOAD:CP:POWer:AC#:DEVIation:FACTOR
 LOAD:CP:KVA:AC#:DEVIation:FACTOR

Frequency commands:

[SOURCE:]FREQUency#:DEVIation:FACTOR

DC commands:

[SOURCE:]VOLTage:DC#:DEVIation:FACTOR
 [SOURCE:]CURRent:DC#:DEVIation:FACTOR
 LOAD:CR:RESistance:DC#:DEVIation:FACTOR
 LOAD:CR:CONductance:DC#:DEVIation:FACTOR
 LOAD:CP:POWer:DC#:DEVIation:FACTOR
 LOAD:CP:KVA:DC#:DEVIation:FACTOR

Phase commands:

[SOURCE:]PHASe#:DEVIation:FACTOR

Command Syntax Description	<p>[SOURce:]VOLTage[:AC]#:DEVIation:FACTOR</p> <p>This command allows to change the multiplicity factor to calibrate the setpoint deviation for the selected phase # or for all phases if phase reference is omitted.</p> <p>Regardless of the phases, with a single parameter you would set the factor value of variable #1, but you can set the others using comma-separated values, as indicated in the parameter format.</p> <p>See formula.</p>
Parameters	<REQ: FACT. VARIABLE #1, OPT: FACT. VARIABLE #2, OPT: FACT. VARIABLE #3>
Parameter Format Example	<p><nr2> <nr2>, <nr2>, <nr2></p> <p>SOUR:VOLT:AC:DEVI:FACT 2.5 → set factor of #1 of all phases</p> <p>SOUR:VOLT:AC1:DEVI:FACT 2.5 → set factor of #1 of phase A</p> <p>SOUR:VOLT:AC:DEVI:FACT 2.5, 2.5, 2.5 → set factor of #1, #2 and #3 of all phases</p>
Query Format Returned Data Format	<p>[SOURce:]VOLTage[:AC]#:DEVIation:FACTOR?</p> <p><nr2>, <nr2>, <nr2> </p> <p><nr2>, <nr2>, <nr2>, <nr2>, <nr2>, <nr2>, <nr2>, <nr2></p>
Query Example	<p>SOUR:VOLT:AC:DEVI:FACT?</p> <p>2.5000,0.0000,0.0000,2.0000,0.0000,0.0000,2.0000,0.0000,0.0000</p> <p>SOUR:VOLT:AC1:DEVI:FACT?</p> <p>2.5000,0.0000,0.0000</p>
Query Format Description Returned Data Format Query Example	<p>[SOURce:]VOLTage[:AC]#:DEVIation:FACTOR:MINimum?</p> <p>This command returns the lowest value allowed for factor.</p> <p><nr2></p> <p>SOUR:VOLT:AC:DEVI:FACT:MIN?</p> <p>-999.999</p>
Query Format Description Returned Data Format Query Example	<p>[SOURce:]VOLTage[:AC]#:DEVIation:FACTOR:MAXimum?</p> <p>This command returns the highest value allowed for factor.</p> <p><nr2></p> <p>SOUR:VOLT:AC:DEVI:FACT:MAX?</p> <p>999.999</p>
Query Format Description Parameters Returned Data Format Query Example	<p>[SOURce:]VOLTage[:AC]#:DEVIation:FACTOR:DEFault?</p> <p>This command returns the default value for factor.</p> <p>None</p> <p><nr2></p> <p>SOUR:VOLT:AC:DEVI:FACT:DEF?</p> <p>0.000</p>
Command Syntax	[SOURce:]VOLTage[:AC]#:DEVIation:VARIABLE

Description	<p>This command allows to change the variable type which will affect the setpoint, for the selected phase # or for all phases if phase reference is omitted. You can get the list of available variables using VOLT:DEVI:VAR:CAT? command.</p> <p>Regardless of the phases, with a single parameter you would set the variable value of variable #1, but you can set the others using comma-separated values, as indicated in the parameter format</p>
Parameters	<REQ: VARIABLE FOR #1, OPT: VARIABLE FOR #2, OPT: VARIABLE FOR #3>
Parameter Format	<nr1> <nr1>, <nr1>, <nr1>
Example	<p>SOUR:VOLT:AC:DEVI:VAR 1 → set variable for #1 of all phases.</p> <p>SOUR:VOLT:AC1:DEVI:VAR 2 → set variable for #1 of phase A.</p> <p>SOUR:VOLT:AC:DEVI:VAR 3, 4, 1 → set variable for #1, #2 and #3 of all phases.</p>
Query Format	[SOURce:]VOLTage[:AC]#:DEViation:VARiable?
Returned Data Format	<nr1>, <nr1>, <nr1> <nr1>, <nr1>, <nr1>, <nr1>, <nr1>, <nr1>, <nr1>, <nr1>
Query Example	<p>SOUR:VOLT:AC:DEVI:VAR? 3,4,1,3,4,1,3,4,1</p> <p>SOUR:VOLT:AC1:DEVI:VAR? 3,4,1</p>
Query Format	[SOURce:]VOLTage[:AC]#:DEViation:VARiable:CATalog?
Description	This command returns the available variable types for a setpoint deviations.
Parameters	None
Returned Data Format	<nr1>,<cr>,...,<nr1>,<cr>
Query Example	<p>SOUR:VOLT:AC:DEVI:VAR:CAT? 0,None,1,Voltage RMS,2,Voltage AC RMS,3,Voltage DC,4,Voltage DC Absolute,5,Voltage LL RMS,6,Voltage LL AC RMS,7,Voltage LL DC,8,Voltage LL DC Absolute,9,Current RMS,10,Current AC RMS,11,Current DC,12,Current DC Absolute,13,Active Power,14,Apparent Power,15,Frequency</p>

Command Syntax Description	<p>[SOURce:]VOLTage[:AC]#:DEVIation:VARiable:CENTer</p> <p>This command allows to change the variable center based on the chosen variable, to calculate the setpoint deviation for the selected phase # or for all phases if phase reference is omitted. Regardless of the phases, with a single parameter you would set the factor value of variable #1, but you can set the others using comma-separated values, as indicated in the parameter format.</p>
Parameters Parameter Format Example	<p><REQ: CENTER FOR #1, OPT: CENTER FOR #2, OPT: CENTER FOR #3> <nr2> <nr2>, <nr2>, <nr2></p> <p>SOUR:VOLT:AC:DEVI:VAR:CENT 50.0 → set center for #1 of all phases. SOUR:VOLT:AC1:DEVI:VAR:CENT 50.0 → set center for #1 of phase A. SOUR:VOLT:AC:DEVI:VAR:CENT 50.0, 50.0, 50.0 → set center for #1, #2 and #3 of all phases.</p>
Query Format Returned Data Format	<p>[SOURce:]VOLTage[:AC]#:DEVIation:VARiable:CENTer?</p> <p><nr2>, <nr2>, <nr2> <nr2>, <nr2>, <nr2>, <nr2>, <nr2>, <nr2>, <nr2>, <nr2>, <nr2></p>
Query Example	<p>SOUR:VOLT:AC:DEVI:VAR:CENT? 50.00,0.00, 0.00, 0.00, 0.00, 0.00, 0.00, 0.00, 0.00</p> <p>SOUR:VOLT:AC1:DEVI:VAR:CENT? 50.00, 0.00, 0.00</p>
Query Format Description Returned Data Format Query Example	<p>[SOURce:]VOLTage[:AC]#:DEVIation:VARiable:CENTer:MINimum?</p> <p>This command returns the lowest value allowed for variable center.</p> <p><nr2></p> <p>SOUR:VOLT:AC:DEVI:VAR:CENT:MIN? -999.999</p>
Query Format Description Returned Data Format Query Example	<p>[SOURce:]VOLTage[:AC]#:DEVIation:VARiable:CENTer:MAXimum?</p> <p>This command returns the highest value allowed for variable center.</p> <p><nr2></p> <p>SOUR:VOLT:AC:DEVI:VAR:CENT:MAX? 999.999</p>
Query Format Description Parameters Returned Data Format Query Example	<p>[SOURce:]VOLTage[:AC]#:DEVIation:VARiable:CENTer:DEFault?</p> <p>This command returns the default value.</p> <p>None</p> <p><nr2></p> <p>SOUR:VOLT:AC:DEVI:VAR:CENT:DEF? 0.000</p>

<p>Command Syntax Description</p> <p>Parameters Parameter Format Example</p> <p>Query Format Returned Data Format Query Example</p>	<p>[SOURCE:]VOLTage[:AC]#:DEVIation:SLEW This command allows configuring the speed with which the deviation will affect the setpoint for the selected phase # or for all phases if phase reference is omitted. <REQ: SLEW Phase #> <nr2> SOUR:VOLT:AC:DEVI:SLEW 0.01 SOUR:VOLT:AC1:DEVI:SLEW 0.01</p> <p>[SOURCE:]VOLTage[:AC]#:DEVIation:SLEW? <nr2> <nr2>,<nr2>,<nr2> 0.01</p>
<p>Query Format Description Returned Data Format Query Example</p>	<p>[SOURCE:]VOLTage[:AC]#:DEVIation:SLEW:MINimum? This command returns the lowest value allowed for slew rate. <nr2> SOUR:VOLT:AC:DEVI:SLEW:MIN? 0.010</p>
<p>Query Format Description Returned Data Format Query Example</p>	<p>[SOURCE:]VOLTage[:AC]#:DEVIation:SLEW:MAXimum? This command returns the highest value allowed for slew rate. <nr2> SOUR:VOLT:AC:DEVI:SLEW:MAX? 1500.000</p>
<p>Query Format Description Parameters Returned Data Format Query Example</p>	<p>[SOURCE:]VOLTage[:AC]#:DEVIation:SLEW:DEFault? This command returns the default value. None <nr2> SOUR:VOLT:AC:DEVI:SLEW:DEF? 0.100</p>
<p>Command Syntax Description</p> <p>Parameters Parameter Format Example</p> <p>Query Format Returned Data Format Query Example</p>	<p>[SOURCE:]VOLTage[:AC]#:DEVIation:RANGE This command sets the maximum deviation allowed for the selected phase # or for all phases if phase reference is omitted. <REQ: RANGE Phase #> <nr2> SOUR:VOLT:AC:DEVI:RANG 1000.00 SOUR:VOLT:AC1:DEVI:RANG 1000.00</p> <p>[SOURCE:]VOLTage[:AC]#:DEVIation:RANGE? <nr2> <nr2>,<nr2>,<nr2> SOUR:VOLT:AC1:DEVI:RANG? 1000.0</p>

Query Format	[SOURce:]VOLTage[:AC]#:DEVlation:RANGe:MINimum?
Description	This command returns the lowest value allowed for range.
Returned Data Format	<nr2>
Query Example	SOUR:VOLT:AC:DEVI:RANG:MIN? 0.000

Query Format	[SOURce:]VOLTage[:AC]#:DEVlation:RANGe:MAXimum?
Description	This command returns the highest value allowed for range.
Returned Data Format	<nr2>
Query Example	SOUR:VOLT:AC:DEVI:RANG:MAX? 1000.000

Query Format	[SOURce:]VOLTage[:AC]#:DEVlation:RANGe:DEFault?
Description	This command returns the default value.
Parameters	None
Returned Data Format	<nr2>
Query Example	SOUR:VOLT:AC:DEVI:RANG:DEF? 1000

Query Format	[SOURce:]DEVlation:ALL?
Description	This query command returns a comma-separated values string of the entire deviation parameters, settings, and limits. Each set value is preceded by a tag identifying the parameter. This same data structure is used for front panel display and by the web server. The advantage is that this command returns all inrush related information using just one query command.
Parameters	None
Returned Data Format	<cr>
Query Example	DEVI:ALL? factor,2.500,2.500,2.000,2.000,0.000,0.000,0.000,0.000,0.000,...

8.7.3 Real Time Voltage Slew Rate Programming Commands

These voltage slew rate settings are intended for use with analog input AC or DC voltage programming when in Source mode of operation. In analog programming mode, the output is the amplified input with the rise time limited by this programmable slew rate setting or by the power stage response time. (100us approx.). Do not confuse these commands with the programable voltage slew rates for voltage settings, see **[SOURce:]VOLTage[:AC]#:SLEW** in section 8.7.2.

By default this setting is at the maximum, so the output voltage would be the most similar to the input plus the response of the output stage. See the picture below where this slew rate is used to limit the rise time of the output regardless of input.

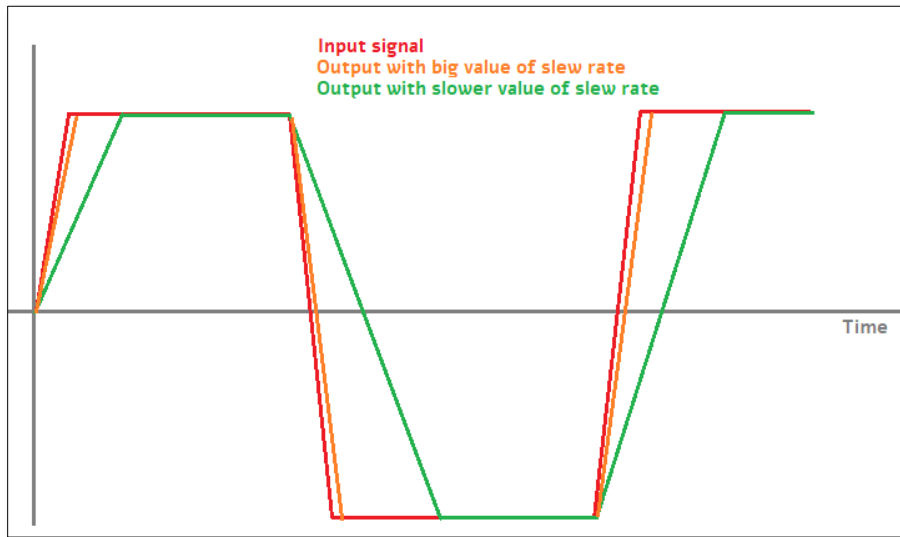

<p>Command Syntax</p> <p>Description</p> <p>Parameters</p> <p>Parameter Format</p> <p>Example</p> <p>Query Format</p> <p>Description</p> <p>Returned Data Format</p> <p>Query Example</p>	<p>[SOURCE:]SLEW:VOLTage <nr2></p> <p>Sets the maximum real-time voltage slew rate value associated with analog programming mode.</p> <p>Voltage slew rate</p> <p><nr2></p> <p>CURR:AC:SLEW 10.00</p> <p>[SOURCE:]SLEW:VOLTage?</p> <p>Returns voltage slew rate setting for all phases.</p> <p><nr2></p> <p>SLEW:VOLT?</p> <p>10.0000</p>
<p>Query Syntax</p> <p>Description</p> <p>Returned Data Format</p> <p>Query Example</p>	<p>[SOURCE:]SLEW:VOLTage:MINimum?</p> <p>Returns the minimum real-time voltage slew rate setting associated with analog programming mode.</p> <p><nr2></p> <p>SLEW:VOLT:MIN?</p> <p>0.010</p>
<p>Query Syntax</p> <p>Description</p> <p>Returned Data Format</p> <p>Query Example</p>	<p>[SOURCE:]SLEW:VOLTage:MAXimum?</p> <p>Returns the maximum real-time voltage slew rate setting associated with analog programming mode.</p> <p><nr2></p> <p>SLEW:VOLT:MAX?</p> <p>0.010</p>

Query Syntax	[SOURce:]SLEW:VOLTage:DEFault?
Description	Returns the default real-time voltage slew rate setting associated with analog programming mode.
Returned Data Format	<nr2>
Query Example	SLEW:VOLT:DEF? 0.010

8.7.4 Frequency Programming Commands

Command Syntax	[SOURce:]FREQuency
Description	Sets output frequency for all phases. Not valid when the source is in DC mode. Sending a FREQ command while the source is in DC mode will result in an error. The query form will return 0.000 when in DC mode.
Parameters	15.00 – 1000.0
Parameter Format	<nr2>
Example	FREQ 400.0
Query Format	[SOURce:]FREQuency?
Returned Data Format	<nr2>
Query Example	FREQ? 400.0000
Command Syntax	[SOURce:]FREQuency:LOWrange
Description	Enables extended output lower frequency mode (1Hz ~ 15Hz) for all phases. Note that maximum voltage and power levels are reduced for extended frequency operation.
Parameters	[0 OFF 1 ON]
Parameter Format	<nr2>
Example	FREQ:LOW 1
Query Format	[SOURce:]FREQuency:LOWrange?
Returned Data Format	
Query Example	FREQ:LOW? 1
Command Syntax	[SOURce:]FREQuency:LIMit:MINimum
Description	Sets the lower user limit for frequency programming. Not that the lower limit set value must be less than the upper limit set value or an error will be generated and no change to the set value will take place. The lower limit set value must fall within the source specified frequency range capability.
Parameters	1.00 – 1000.0
Parameter Format	<nr2>
Example	FREQ:LIM:MIN 47.0
Query Format	[SOURce:]FREQuency:LIMit:MINimum?
Returned Data Format	<nr2>
Query Example	FREQ:LIM:MIN? 47.0000

Command Syntax Description	[SOURCE:]FREQUENCY:LIMIT:MAXIMUM Sets the upper user limit for frequency programming. Note that the upper limit set value must be greater than the lower limit set value or an error will be generated and no change to the set value will take place. The upper limit set value must fall within the source specified frequency range capability.
Parameters Parameter Format Example Query Format Returned Data Format Query Example	15.00 – 1000.0 <nr2> FREQ:LIM:MAX 63.0 [SOURCE:]FREQUENCY:LIMIT:MAXIMUM? <nr2> FREQ:LIM:MAX? 63.0000
Query Format Description Returned Data Format Query Example	[SOURCE:]FREQUENCY:LIMIT:RANGE? This command returns the lower and upper frequency user limit set value.s <nr2>, <nr2> FREQ:LIM:RANG? 53.0000,63.0000
Command Syntax Description Parameters Parameter Format Example Query Format Returned Data Format Query Example	[SOURCE:]FREQUENCY:SLEW Sets the frequency slew rate in Hz/msec. This command is not valid when in DC mode. 0.01 – 1000.00 <nr2> FREQ:SLEW 100.0 [SOURCE:]FREQUENCY:SLEW? <nr2> FREQ:SLEW? 100.0000
Query Format Description Returned Data Format Query Example	[SOURCE:]FREQUENCY:SPAN? This command is provided to support backward compatibility with Pacific Power UPC controllers. Refer also to the “ SYSTEM:COMPATIBLE ” command. For AZX Series®, this query always returns 0.0000 <nr2> FREQ:SPAN? 1000.0000

8.7.5 Current Limit Programming Commands

Command Syntax	[SOURce:]CURRent:LIMit#
Description	This command sets the programmable current level for the selected phase #. If # is omitted, sets all phases to current level specified. The value set cannot exceed the maximum current capability of the power source as returned by the “[SOURce:]CURRent:LIMit#:MAX?” command. If the load current exceeds the current limit set point, the source will go into constant current mode to maintain the load current at the set limit level.
Parameters	0.00 – MAX
Parameter Format	<nr2>
Example	CURR:LIM 20.5
Query Format	[SOURce:]CURRent:LIMit#?
Returned Data Format	<nr2>
Query Example	CURR:LIM? 130.00,130.00,130.00
Query Format	[SOURce:]CURRent:LIMit#:MAX?
Description	This command returns the maximum available programmable current limit setting. Note that the returned value is a function of the “SYSTEM:COMPAtible” setting
UPC	If UPC mode is enabled, this command always returns 2000.0000 to emulate the UPC controllers
DISABLED	With UPC mode disabled, this command returns the max. available current output per phase. This value is a function of the AZX model and the number of units that are connected in parallel.
Returned Data Format	<nr2>
Query Example	CURR:LIM:MAX? 130.00
Query Format	[SOURce:]CURRent:LIMit#:DEFault?
Description	This command returns the default current limit setting at power up for the referenced phase.
Returned Data Format	<nr2>
Query Example	CURR:LIM1:DEF? 130.00
Query Format	[SOURce:]CURRent:LIMit#:MAXimum?
Description	This command returns the maximum current limit setting available for the referenced phase.
Returned Data Format	<nr2>
Query Example	CURR:LIM:MAX1? 130.00

Query Format	[SOURCE:]CURRENT:LIMit#:MINimum?
Description	This command returns the minimum current limit setting available for the referenced phase.
Returned Data Format	<nr2>
Query Example	CURR:LIM:MIN1? 0.000
Command Syntax	[SOURCE:]CURRENT:LIMit:AUTO
Description	This commands enables or disables the Auto Current Limit function. This function automatically adjusts the programmed current limit level as a function of programmed voltage along the constant power curve of the voltage range. For example: On a 3550AZX model in three phase mode, if VOLT = 0 and CURR:LIM = 130.00 and voltage is changed to V = 300, the CURR:LIM will change to: 16667 VA / 300 Vac = 55.5A If CURR:LIM:AUTO = OFF then the CURR:LIM setting will remain at 130.00A.
Parameters	< 0 OFF 1 ON >
Parameter Format	
Example	CURR:LIM:AUTO ON
Query Format	[SOURCE:]CURRENT:LIMit:AUTO?
Returned Data Format	
Query Example	CURR:LIM:AUTO? 1

8.7.6 Phase Programming Commands



Command Syntax	[SOURCE:]PHASe#
Description	This command programs the phase angle for the selected phase. A phase reference (#) must be specified. Note that unless external sync mode is used, the A phase (# = 1) cannot be programmed is fixed at 0 degrees.
Parameters	0.0 – 359.9
Parameter Format	<nr2>
Example	PHAS2 122.5
Query Format	[SOURCE:]PHASe#?
Returned Data Format	<nr2>
Query Example	PHAS2? 122.5
Command Syntax	[SOURCE:]PHASe#:SLEW
Description	This command sets slew rate for the phase angle for the selected phase. A phase reference (#) must be specified. Note that unless external sync mode is used, the A phase (# = 1) slew rate cannot be programmed is fixed at 0 degrees.
Parameters	0.01 – 359.91
Parameter Format	<nr2>
Example	PHAS3:SLEW 10.25
Query Format	[SOURCE:]PHASe#:SLEW?
Returned Data Format	<nr2>
Query Example	PHAS3:SLEW? 10.2500
Command Syntax	[SOURCE:]PHASe:ROTation
Description	This command sets default phase rotation at power on. Available settings are POSITIVE (1) or NEGATIVE (0). This setting effectively swaps phases B and C and may be used to set the required phase rotation for AC motors.
Parameters	[0 NEGative 1 POSitive] 0 = NEGATIVE 1 = POSITIVE
Parameter Format	
Example	PHAS:ROT POS
Query Format	[SOURCE:]PHASe:ROTation?
Returned Data Format	
Query Example	PHAS:ROT? 1

Command Syntax	[SOURCE:]PHASe:SPLIT
Description	This command sets the split phase mirroring mode. This mode allows non-symmetrical AC arbitrary waveforms to be used when in split phase mode. Default state is on.
Parameters	[0 OFF 1 ON] 0 = OFF 1 = ON
Parameter Format	
Example	PHAS:SPLIT ON
Query Format	[SOURCE:]PHASe:SPLIT?
Returned Data Format	
Query Example	PHAS:SPLIT? 1

8.7.7 Waveform Programming Commands

Waveform Storage

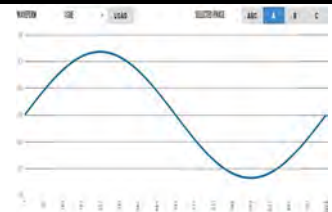
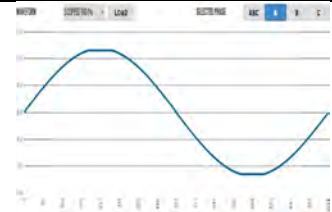
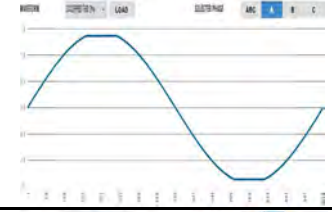
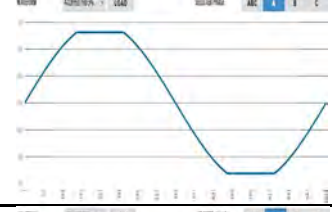
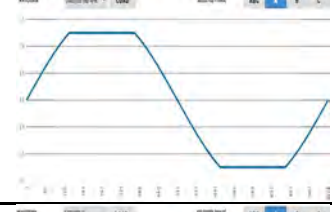
The AZX Series® offers full arbitrary waveform programming capability in addition to the standard waveforms that are provided. A total of 16 waveform registers are available. The default content of these registers is shown in the table below. Also shown are the waveform number names and the waveform description each waveform.

Name	Description	Image	Notes
1	SINE		Standard sine wave. No harmonic content. This is also the default selected waveform at power on unless a power-on setup is recalled.
2	CLIPPED THD 1%		Clipped sine with 1% total harmonic voltage distortion due to flat topping of sinewave peaks.
3	CLIPPED THD 2%		Clipped sine with 2% total harmonic voltage distortion due to flat topping of sinewave peaks.
4	CLIPPED THD 5%		Clipped sine with 5% total harmonic voltage distortion due to flat topping of sinewave peaks.
5	CLIPPED THD 10%		Clipped sine with 10% total harmonic voltage distortion due to flat topping of sinewave peaks.
6	SQUARE LF		Square wave. Consists of fundamental and all odd harmonics. The LF (low frequency) version is recommended for use below 100Hz.

Name	Description	Image	Notes
7	SQUARE HF		Square wave. Consists of fundamental and all odd harmonics. The HF (high frequency) version is recommended for use above 100Hz.
8	SAWTOOTH LF		Saw tooth. Consist of fundamental and both odd and even harmonics. Note: Not recommended for conventional power applications. LF use < 100Hz.
9	SAWTOOTH HF		Saw tooth. Consist of fundamental and both odd and even harmonics. Note: Non-linear! Not recommended for conventional power applications. HF use > 100Hz.
10	TRIANGLE		Triangle. Similar to saw tooth but at same fundamental as a sine wave. Contains fundamental and odd harmonics with amplitudes that roll off as the inverse square of the harmonic number. (1/3, 1/9, 1/25 etc).
11~200	USER DEFINED	Number, ALIAS	User defined waveforms

Table 8-2: Available Included AZX Series® Waveforms

Commands

<p>Command Syntax Description</p>	<p>[SOURCE:]WAVEFORM:AUTORMS <BOOLEAN> If enabled, the value of the waveform is normalized in order to match the RMS set point. If disabled, the waveform is reproduced without any normalization. This function is useful for waveform substitution at the steady state level. Note: This function is related to the AUTORMS function in the transient segment but it is not the same. Note: UPC has AUTORMS always enabled for steady state. It is not an option in UPC Mode.</p>
<p>Parameters Parameter Format Example Query Format Returned Data Format Query Example</p>	<p>0 1 ON OFF WAVEFORM:AUTORMS OFF [SOURCE:]WAVEFORM:AUTORMS? SOURCE:WAVEFORM:AUTORMS? 0</p>
<p>Query Format Description</p>	<p>[SOURCE:]WAVEFORM:CATalog? This command returns the list of available waveforms by name. Names can only be numbers. For more descriptive names, see the .”[SOURCE:]WAVEFORM:CATalog:ALIAS?” command instead.</p>
<p>Returned Data Format Query Example</p>	<p><cr> WAVEFORM:CAT? 1,2,3,4,5,6,7,8,9,10,11,12,13,14,15,16</p>
<p>Query Format Description</p>	<p>[SOURCE:]WAVEFORM:CATalog:ALIAS? This command returns the list of available waveforms by description. For each waveform, both the name (number) and description are returned in a comma separated list.</p>
<p>Returned Data Format Query Example</p>	<p><cr> WAVEFORM:CAT:ALIAS? Sine,Clipped THD 1%,Clipped THD 2%,Clipped THD 5%,Clipped THD 10%,Square Fast,Square Slow,Sawtooth Fast,Sawtooth Slow,Triangle,Clip 5% THD,Clip 6% THD,Clip 7% THD,Clip 8% THD,Clip 9% THD,Clip 10% THD</p>
<p>Command Syntax Description</p>	<p>[SOURCE:]WAVEFORM:COPY This command copies the waveform file specified as a PATH parameter to the waveform number specified. The path name is a delimited string.</p>
<p>Parameters Parameter Format Example</p>	<p><PATH>,<NUMBER> <cr>,<nr1> WAVEFORM:COPY “internal/waveforms/1.csv”,25</p>

Command Syntax Description	<p>[SOURCE:]WAVEFORM:DEFine</p> <p>This command sends a string of 1024 data points that constitute a single period of an arbitrary waveform. The data is sent as a comma separated list of <nr2> values. The waveform name to which to apply the new data values is the first parameter in the list and can be from 1 through 16.</p> <p>Note: Data values are scaled based on an RMS value of 1 so for a sine wave, the max data value is 1.414 and the min data value is -1.414</p>
Parameters Parameter Format Example	<p>1024 data values separated by commas</p> <p><nr1>,<nr2>, <nr2>.....,<nr2></p> <p>WAVEFORM:DEF 16,0.0000,0.0068,0.0135,0.0203,....,-0.0203,-0.0135,-0.0068</p>
Query Format Returned Data Format Query Example	<p>[SOURCE:]WAVEFORM:DEFine? <nr1></p> <p><nr2>, <nr2>.....,<nr2></p> <p>SOURCE:WAVEFORM:DEF? 16</p> <p>0.0000,0.0068,0.0135,0.0203, ,-0.0203,-0.0135,-0.0068</p>
Query Format Description	<p>[SOURCE:]WAVEFORM:DEFine:BYALIAS?</p> <p>This command is similar to the WAVEFORM:DEF? query but instead of specifying the waveform name as 1 – 16, the waveform alias name is used to select the waveform. Waveform aliases are passed as a quoted string. E.g. "Sine".</p>
Returned Data Format Query Example	<p><nr2>, <nr2>.....,<nr2></p> <p>WAVEFORM:DEFine:BYALIAS? "Sine"</p> <p>0.0000,0.0087,0.0174,0.0260,0.0347,....,-0.0260,-0.0174,-0.0087</p>
Command Syntax Description	<p>[SOURCE:]WAVEFORM:DELeTe <nr1></p> <p>This command deletes a user defined waveform from any location higher than 1.</p>
Parameters Parameter Format Example	<p>Waveform number</p> <p><nr1></p> <p>WAVEFORM:DEL 16</p>
Query Format Description	<p>[SOURCE:]WAVEFORM:EXIST? <nr1></p> <p>This command returns a 1 if the waveform location referenced contains waveform data or a 0 is the waveform location is empty (No waveform exists).</p>
Returned Data Format Query Example	<p><nr1></p> <p>WAVEFORM:EXIST? 34</p> <p>0</p>

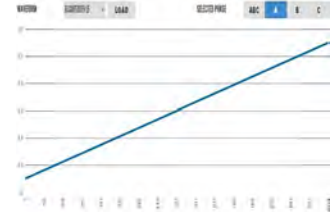
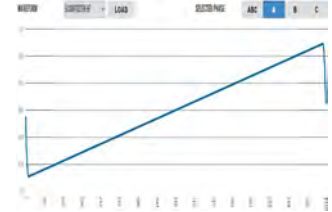
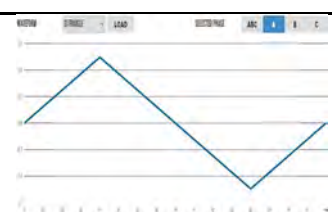
<p>Command Syntax Description</p>	<p>[SOURCE:]WAVEFORM#:LOAD This command loads the currently selected waveform to the actual output register of the controller causing it output the waveform on the selected phase #.</p>
<p>Parameters</p>	<p>1, 2, 3</p>
<p>Parameter Format</p>	<p><nr1></p>
<p>Example</p>	<p>WAVEFORM1:LOAD</p>
<p>Query Format</p>	<p>[SOURCE:]WAVEFORM#:LOAD? <nr1></p>
<p>Returned Data Format</p>	<p><nr1>, <cr></p>
<p>Query Example</p>	<p>SOURce:WAVEFORM1:LOAD? 1 1, Sine</p>
<p>Command Syntax Description</p>	<p>[SOURCE:]WAVEFORM:RESTORE This command restores the first 16 waveforms registers by replacing waveform 1 to 16 with the factory defaults. See section 8.7.7. Note: This command is useful if waveforms 2 through 15 were overwritten with user-defined waveforms.</p>
<p>Parameters</p>	<p>None</p>
<p>Parameter Format</p>	<p>n/a</p>
<p>Example</p>	<p>WAVEFORM:RESTORE</p>
<p>Query Format</p>	<p>None</p>
<p>Command Syntax Description</p>	<p>[SOURCE:]WAVEFORM#:SElect This command selects a waveform by alias (name) or number. When using the WAVEFORM:x commands, the ALIAS NUMBER is not passed as it uses the selected one. This is to avoid passing the waveform number to every command</p>
<p>Parameters</p>	<p><ALIAS NUMBER, OPT: ALIAS NUMBER , OPT: ALIAS NUMBER > The first parameter is required. Additional optional waveforms or numbers may be added when operating the source in 2 or 3 phase mode. The waveform selection sequence by phase is A, B, C.</p>
<p>Parameter Format</p>	<p><cr> or <nr1></p>
<p>Example</p>	<p>WAVEFORM:SEL SINE WAVEFORM:SEL 1,2,3 WAVEFORM:SEL 5</p>
<p>Query Format</p>	<p>[SOURCE:]WAVEFORM#:SElect?</p>
<p>Returned Data Format</p>	<p><cr> or <nr1></p>
<p>Query Example</p>	<p>WAVEFORM:SEL? 1,1,1 (FORM 3) WAVEFORM:SEL? 1,1 (FORM 2) WAVEFORM:SEL? 1 (FORM 1)</p>

Command Syntax Description	[SOURCE:]WAVEFORM:SINEwave This command modifies the #1 Sinewave harmonic content to reduce voltage distortion at lower frequencies (< 100Hz). It does so by disabling the 3 rd Harmonic component that is normally included to improve voltage distortion at high frequencies. Turning this OFF (0) is recommended for Harmonics and Flicker system applications at 50 and 60 Hz. For Avionics and Defense applications at 400Hz or higher, this mode should re-enabled (1). Not that this setting is saved in non-volatile memory and is retained between power on/off cycles of the power source.
Parameters Parameter Format Example Query Format Query Example	 n/a SOUR:WAVEFORM:SINE 0 SOURCE:WAVEFORM:SINEwave? SOUR:WAVEFORM:SINE? 0
Command Syntax Description	[SOURCE:]WAVEFORM:SMOOTHen <NUMBER> This command Sets the smoothing filter size that is applied to the waveform, in sample counts. A value of 1 makes the filter have no effect (Disabled) and the maximum value is 101. Only odd numbers are considered. The type of filter used is a moving-average-filter, or MAF. The smoothing filter is used to reduce slew rates of waveform edges. This is useful in certain applications to make the waveform reproduction more consistent and reduce potential distortion due to the sampling rate of the controller, especially when reproducing waveforms at high frequency.
Parameters Parameter Format Example Query Format Returned Data Format Query Example	NUMBER <nr1> WAVEFORM:SMOOTH 33 [SOURCE:]WAVEFORM:SMOOTHen? <nr1> WAVEFORM:SMOOTH? 33

<p>Command Syntax Description</p>	<p>[SOURCE:]WAVEFORM#:NAME Set waveform for selected phase to the waveform name passed as a parameter. If no waveform name parameter is specified, the query format returns the name of the selected waveform. See WAVEFORM#[[:NAME]] command.</p>
<p>Parameters Parameter Format Example Query Format Returned Data Format Query Example</p>	<p>1 – 16 <nr1> WAVEFORM1 4 [SOURCE:]WAVEFORM#:NAME? <nr1> SOUR:WAVEFORM1? 4</p>
<p>Command Syntax Description</p>	<p>[SOURCE:]WAVEFORM#:ALIAS Analogous to the WAVEFORM#[[:NAME]] command but in place of the waveform name, the waveform description is passed as a quoted string.</p>
<p>Parameters Parameter Format Example Query Format Description Returned Data Format Query Example</p>	<p>Waveform description as quoted string. <cr> WAVEFORM1:NAME:BYALIAS "Triangle" [SOURCE:]WAVEFORM#:ALIAS? Analogous to the WAVEFORM#[[:NAME]]? query command but in place of the waveform name, the alias is returned as a string. <cr> WAVEFORM1:ALIAS? Triangle</p>
<p>Command Syntax Description</p>	<p>[SOURCE:]WAVEFORM#:LOAD Sets the waveform name (1 – 16) to be loaded for the selected phase # for the next SWITCH command. If # is omitted, sets all available phases to waveform name specified. Note: The waveform LOAD command loads the selected phase's waveform registers with the waveform data for the specified waveform name but does not cause it to appear at the output until the WAVEFORM:SWITCH command is received.</p>
<p>Parameters Parameter Format Example Query Format Returned Data Format Query Example</p>	<p>1 – 16 <nr1> WAVEFORM2:LOAD 12 [SOURCE:]WAVEFORM#:LOAD? <nr1> or <nr1>,<nr1>,nr1> WAVEFORM:LOAD? 1,12,1</p>

Command Syntax	[SOURCE:]WAVEFORM#:SWITCH
Description	When sent for the selected phase, the output waveform is switched over to the new waveform name that was last set with the WAVEFORM#:LOAD command. . If # is omitted, sets all available phases' waveforms are switched.
Parameters	None other than phase selected in command string
Parameter Format	n/a
Example	WAVEFORM1:SWITCH

8.7.8 Voltage Protection Programming Commands

Note: For all protection commands, # = Phase 1, 2 or 3 select or omit for all phases.

Command Syntax	[SOURce:]PROTect:PEAK:VOLTage#:STATe
Description	This command enables or disables the peak voltage protection.
Parameters	< 0 OFF 1 } ON >
Parameter Format	
Example	PROT:PEAK:VOLT1:STAT 1
Query Format	[SOURce:]PROTect:PEAK:VOLTage#:STATe?
Returned Data Format	<nr1>
Query Example	PROT:PEAK:VOLT1:STAT? 1

Command Syntax	[SOURce:]PROTect:PEAK:VOLTage:MODE < 0 MARGin 1 LEVel 2 BOTH >
Description	This command sets the voltage peak mode of operation.
Parameters	< 0 MARGin 1 LEVel 2 BOTH >
	Encoding:
	MARGin 0 Relative level
	LEVel 1 Absolute level
	BOTH 2 Both
Parameter Format	<cr> <nr1>
Example	PROT:PEAK:VOLT:MODE BOTH
Query Format	[SOURce:]PROTect:PEAK:VOLTage:MODE?
Returned Data Format	<nr2>
Query Example	PROT:PEAK:VOLT:MODE? 2

Command Syntax	[SOURce:]PROTect:PEAK:VOLTage:MARGin <VOLTAGE MARGIN>
Description	This command sets the maximum voltage peak margin. If the output voltage peak exceeds the programmed peak margin by more than this amount, an error is tripped.
Parameters	<VOLTAGE MARGIN>
Parameter Format	<nr2>
Example	PROT:PEAK:VOLT:MARG 120.0
Query Format	[SOURce:]PROTect:PEAK:VOLTage:MARGin?
Returned Data Format	<nr2>
Query Example	PROT:PEAK:VOLT:MARG? 120.000

Query Syntax	[SOURce:]PROTect:PEAK:VOLTage:MARGin:MINimum?
Description	This command returns the minimum voltage peak margin setting.
Query Example	PROT:PEAK:VOLT:MARG:MIN? 0.000

<p>Query Syntax Description Query Example</p>	<p>[SOURCE:]PROTECT:PEAK:VOLTage:MARGin:MAXimum? This command returns the maximum voltage peak margin setting PROT:PEAK:VOLT:MARG:MAX? 500.000</p>
<p>Query Syntax Description Query Example</p>	<p>[SOURCE:]PROTECT:PEAK:VOLTage:MARGin:DEFault? This command returns the default voltage peak margin setting PROT:PEAK:VOLT:MARG:DEF? 100.000</p>
<p>Command Syntax Description</p>	<p>[SOURCE:]PROTECT:PEAK:VOLTage:LEVel <VOLTAGE LEVEL> This command sets the maximum voltage peak level. If the output voltage peak exceeds the programmed peak level by more than this amount, an error is tripped.</p>
<p>Parameters Parameter Format Example Query Format Returned Data Format Query Example</p>	<p><VOLTAGE LEVEL> <nr2> PROT:PEAK:VOLT:LEV 120.0 [SOURCE:]PROTECT:PEAK:VOLTage:LEVel? <nr2> PROT:PEAK:VOLT:LEV? 500.000</p>
<p>Query Syntax Description Query Example</p>	<p>[SOURCE:]PROTECT:PEAK:VOLTage:LEVel:MINimum? This command returns the minimum voltage peak level setting. PROT:PEAK:VOLT:LEV:MIN? 0.000</p>
<p>Query Syntax Description Query Example</p>	<p>[SOURCE:]PROTECT:PEAK:VOLTage:LEVel:MAXimum? This command returns the maximum voltage peak level setting PROT:PEAK:VOLT:LEV:MAX? 500.000</p>
<p>Query Syntax Description Query Example</p>	<p>[SOURCE:]PROTECT:PEAK:VOLTage:LEVel:DEFault? This command returns the default voltage peak level setting PROT:PEAK:VOLT:LEV:DEF? 500.000</p>
<p>Query Syntax Description</p>	<p>[SOURCE:]PROTECT:PEAK:VOLTage:TRIPped? This command returns 1 if the voltage peak protection has been tripped or 0 if no trip occurred.</p>
<p>Query Example</p>	<p>PROT:PEAK:VOLT:TRIP? 0.000</p>
<p>Command Syntax</p>	<p>[SOURCE:]PROTECT:PEAK:VOLTage:TRIPped:CLEar</p>

Description	This command clears the peak voltage protection trip status. Once cleared, the power source output can be re-enabled.
Parameters	<VOLTAGE LEVEL>
Parameter Format	<nr2>
Example	PROT:PEAK:VOLT:TRIP:CLE

Query Syntax
 Description
 Query Example

[SOURCE:]PROTEct:ALL?

This command returns protection setting values for all phases.

PROT:PEAK:ALL

```

0,10.00,24.00,0.00,0,10.00,24.00,0.00,0,10.00,24.00,0.00,0,10.00,24.00,0.00,0
,3.0000,3.0000,0.0000,3.0000,3.0000,0.0000,0,3.0000,3.0000,0.0000,3.0000,3
.0000,0.0000,0,3.0000,3.0000,0.0000,3.0000,3.0000,0.0000,0,3.0000,3.0000,0
.0000,3.0000,3.0000,0.0000,0,1000.000,1000.000,0.000,0,1000.000,1000.000,
0.000,0,1000.000,1000.000,0.000,0,1000.000,1000.000,0.000,0,0.000,1000.00
0,0,0.000,0,0.000,1000.000,0.000,0,0.000,1000.000,0.000,0,0.000,1000.000,0.0
00,0,1200.000,1200.000,0.000,0,1200.000,1200.000,0.000,0,1200.000,1200.00
00,0.000,0,1200.000,1200.000,0.000,0,0.000,1200.000,0.000,0,0.000,1200.00
0,0.000,0,0.000,1200.000,0.000,0,0.000,1200.000,0.000,5,1,5,1,5,1,0,0,10
000000,0,0,0.000,100000.000,-
100000.000,0,0,10000000,0,0,0.000,100000.000,-
100000.000,0,0,10000000,0,0,0.000,100000.000,-
100000.000,0,0,10000000,0,0,0.000,100000.000,-
100000.000,0,0,10000000,0,0,0.000,100000.000,-
100000.000,0,0,10000000,0,0,0.000,100000.000,-
100000.000,0,0,10000000,0,0,0.000,100000.000,-
100000.000,0,0,10000000,0,0,0.000,100000.000,-
100000.000,0,0,10000000,0,0,0.000,100000.000,-
100000.000,0,0,10000000,0,0,0.000,100000.000,-
100000.000,0,0,10000000,0,0,0.000,100000.000,-
100000.000,0,0,10000000,0,0,0.000,100000.000,-
100000.000,0,0,10000000,0,0,0.000,100000.000,-
100000.000,0,0,10000000,0,0,0.000,100000.000,-
100000.000,0,0,10000000,0,0,0.000,100000.000,-
100000.000,0,0,10000000,0,0,0.000,100000.000,-
100000.000,0,0,10000000,0,0,0.000,100000.000,-
100000.000,0,0,10000000,0,0,0.000,100000.000,-
100000.000,1,0,0,7,100.000,500.000,0.000,500.000,500.000,0.000,1,0,0,7,100
.000,500.000,0.000,500.000,500.000,0.000,1,0,0,7,100.000,500.000,0.000,500
.000,500.000,0.000,1,0,0,7,100.000,500.000,0.000,500.000,500.000,0.000,0,1,
2,40.000,40.000,1.000,36.000,40.000,1.000,0,1,2,40.000,40.000,1.000,36.000,
40.000,1.000,0,1,2,40.000,40.000,1.000,36.000,40.000,1.000,0,1,2,40.000,40.
000,1.000,36.000,40.000,1.000,0,6.000,6.000,0.000,0,6.000,6.000,0.000,0,6.0
00,6.000,0.000,0,6.000,6.000,0.000
    
```

<p>Command Syntax Description</p>	<p>[SOURce:]PROTeCt:RMS:VOLTage:LEVel <VOLTAGE LEVEL> This command sets the RMS voltage protection level. RMS protections require several cycles so respond slower than Voltage peak protections. Protection delay can be set by the user in 100 msec increments, i.e.a delay of 5 means 500 msec (5x 100ms). See SENSe:FAULT command section below for more info.</p>
<p>Parameters Parameter Format Example Query Format Returned Data Format Query Example</p>	<p><VOLTAGE LEVEL> <nr2> PROT:RMS:VOLT:LEV 120.0 [SOURce:]PROTeCt:RMS:VOLTage:LEVel? <nr2> PROT:RMS:VOLT:LEV? 500.000</p>
<p>Command Syntax Description</p>	<p>[SOURce:]PROTeCt:RMS:xx:STATe This command. Selections for “xx” are”: A, A1, A2, A3, CURRent, CURRent1, CURRent2, CURRent3, kVA, KVA1, KVA2, KVA3, POWer, POWer1, POWer2, POWer3, SHUTDOWN, SHUTDOWN1, SHUTDOWN2, SHUTDOWN3, CONDItion:CATalog?, CONDItion:LEV MIN MAX DEF?</p>
<p>Parameters Parameter Format Example Query Format Returned Data Format Query Example</p>	<p><VOLTAGE LEVEL> <nr1> PROT:RMS:VOLT:LEV 120.0 [SOURce:]PROTeCt:RMS:xx:STATe? <nr1> PROT:RMS:PROT:RMS:A:STAT? 0,0,0</p>
<p>Query Syntax Description</p>	<p>[SOURce:]PROTeCt:RMS:xx:INFO? This command. Selections for “xx” are”: A, A1, A2, A3, B, B1, B2, B3, SHUTDOWN, SHUTDOWN1, SHUTDOWN2, SHUTDOWN3</p>
<p>Query Example</p>	<p>PROT:PEAK:VOLT:TRIP? 0.000</p>

Command Syntax	[SOURCE:]PROTECT:TDELAY <nr1>
Description	This command sets the protection trip delay time in 100 millisecond units, so 1 means 100ms, 2 means 200ms, and so on. It can be queried with PROT:TDELAY? .
Parameters	Delay in 100 msec increments
Parameter Format	<nr1>
Example	PROT:TDEL 5
Query Format	[SOURCE:]PROTECT:TDELAY?
Returned Data Format	<nr1>
Query Example	PROT:TDEL? 5

8.7.9 Voltage Sense Protection Commands

Introduction

The **SENSE:FAULT** is a fault based on the difference between the RMS voltage measurement and the RMS voltage setpoint programmed.

If the **ABS(VOLTAGE_SETPOINT_RMS – VOLTAGE_MEASUREMENT_RMS) > MAX(SENSE:FAULT:LEVEL:PERCENTAGE * VOLTAGE_SETPOINT_RMS, SENSE:FAULT:LEVEL:MIN)** the fault trips and turns the output of the unit off.

The trip time is programmed with **PROT:TDELAY X** where X is in 100 milliseconds unit, so 1 means 100ms, 2 means 200ms, and so on. It can be queried with **PROT:TDELAY?**

As this is a RMS protection it will take at least 100ms to trip, it is not faster than that.

- **SENSE:FAULT:LEVEL:MIN** establishes the minimum difference it will compare in RMS voltage terms.
- **SENSE:FAULT:LEVEL:PERCENTAGE** establishes the difference in terms of a percentage of the programmed RMS setpoint.

The maximum is used to compare, this gives the possibility to program in percentage terms absolute terms, or both.

For example, at 108Vrms programmed, the **ABS(VOLTAGE_SETPOINT_RMS – VOLTAGE_MEASUREMENT_RMS)** should exceed 108Vrms to trip.

For faster voltage protection use **peak voltage protection** which is based on instantaneous values instead of RMS.

Command Syntax Description	SENSe:FAULT:LEVel:MIN <nr2> This command sets the minimum sense voltage at which a voltage sense fault will trip the output. The protection trips if the following condition is fulfilled during a time equal to the protection trip time: $ABS(VOLTAGE_SETPOINT_RMS - VOLTAGE_MEASUREMENT_RMS) > MAX(SENSe:FAULT:LEVel:PERcentage * VOLTAGE_SETPOINT_RMS, SENSe:FAULT:LEVel:MIN)$ By default SENSe:FAULT:LEVel:PERcentage is 10% and SENSe:FAULT:LEVel:MIN is 25 volts.
Parameters Parameter Format Example Query Format Returned Data Format Query Example	<VOLTAGE LEVEL> <nr2> SENS:FAULT:LEV:MIN 120.0 SENSe:FAULT:LEVel:MIN? <nr2> SENS:FAULT:LEV:MIN? 25.000
Command Syntax Description	SENSe:FAULT:LEVel:PERcentage <nr2> This command sets the sense voltage delta between programmed and actual senses voltage in percent of voltage range at which a voltage sense fault will trip the output. The protection trips if the following condition is fulfilled during a time equal to the protection trip time: $ABS(VOLTAGE_SETPOINT_RMS - VOLTAGE_MEASUREMENT_RMS) > MAX(SENSe:FAULT:LEVel:PERcentage * VOLTAGE_SETPOINT_RMS, SENSe:FAULT:LEVel:MIN)$ By default SENSe:FAULT:LEVel:PERcentage is 10% and SENSe:FAULT:LEVel:MIN is 25 volts.
Parameters Parameter Format Example Query Format Returned Data Format Query Example	<VOLTAGE LEVEL> <nr2> SENS:FAULT:LEV:PERC 10.0 SENSe:FAULT:LEVel:PERC? <nr2> SENS:FAULT:LEV:PERC? 10.000
Command Syntax Description	SENSe:PATH This command selects the source for metering and CSC mode as either internal (0) or external (1).
Parameters Parameter Format Example Query Format Returned Data Format Query Example	< 0 1 > SENS:PATH 1 SENSe:PATH? SENS:PATH? 1

8.7.10 Current Protection Programming Commands

Note: For all protection commands, # = Phase 1, 2 or 3 select or omit for all phases.

Command Syntax	[SOURce:]PROTect[:RMS]:CURRent[#:STATe] <ON OFF>
Description	This command enables or disables the rms current protection. If the protection is tripped the power source output is disabled.
Parameters	< ON 1 OFF 0 >
Parameter Format	<nr1> <cr>
Example	PROTect:CURRent1 ON
Query Format	[SOURce:]PROTect[:RMS]:CURRent#[:STATe]?
Returned Data Format	<nr2>
Query Example	PROTect:CURRent? 1

Command Syntax	[SOURce:]PROTect[:RMS]:CURRent#:LEVel <LEVEL>
Description	This command sets the rms current protection level.
Parameters	< LEVEL >
Parameter Format	<nr2>
Example	PROT:CURR1:LEVel 40.0
Query Format	[SOURce:]PROTect[:RMS]:CURRent#:LEVel?
Returned Data Format	<nr2>
Query Example	PROT:CURR:LEV? 40.000

Query Syntax	[SOURce:]PROTect[:RMS]:CURRent:LEVel:MINimum?
Description	This command returns the minimum rms current protection level setting.
Query Example	PROT:CURR:LEV:MIN? 0.000

Query Syntax	[SOURce:]PROTect[:RMS]:CURRent:LEVel:MAXimum?
Description	This command returns the maximum rms current protection level setting.
Query Example	PROT:CURR:LEV:MAX? 41.667

Query Syntax	[SOURce:]PROTect[:RMS]:CURRent:LEVel:DEFault?
Description	This command returns the default rms current protection level setting. This value will be a function of the power source model.
Query Example	PROT:CURR:LEV:DEF? 41.667

Command Syntax	[SOURCE:]PROTECT[:RMS]:CURRENT#:TDELAY <DELAY>
Description	This command sets the rms current protection trip delay in 100 msec increments, i.e. as setting of 5 means 500 msec.
Parameters	< DELAY >
Parameter Format	<nr1>
Example	PROTECT:CURRE:TDELAY 5
Query Format	[SOURCE:]PROTECT[:RMS]:CURRENT#:TDELAY?
Returned Data Format	<nr1>
Query Example	PROT:CURRE:LEV? 5
Query Syntax	[SOURCE:]PROTECT[:RMS]:CURRENT:TDELAY:MINIMUM?
Description	This command returns the minimum rms current protection trip delay setting.
Query Example	PROT:CURRE:TDELAY:MIN? 0
Query Syntax	[SOURCE:]PROTECT[:RMS]:CURRENT:TDELAY:MAXIMUM?
Description	This command returns the maximum rms current protection trip delay setting.
Query Example	PROT:CURRE:TDELAY:MAX? 3000
Query Syntax	[SOURCE:]PROTECT[:RMS]:CURRENT:TDELAY:DEFAULT?
Description	This command returns the default rms current protection trip delay setting.
Query Example	[SOURCE:]PROTECT[:RMS]:CURRENT:TDELAY:DEFAULT? 41.667
Query Syntax	[SOURCE:]PROTECT[:RMS]:CURRENT:TRIPPED?
Description	This command returns rms current protection trip status. Returns 1 if tripped or 0 if not.
Query Example	PROT:CURRE:TRIP? 41.667
Command Syntax	[SOURCE:]PROTECT[:RMS]:CURRENT:TRIPPED:CLEAR
Description	This command clears the rms current protection trip status. Once cleared, the power source output can be enabled.
Parameters	None
Parameter Format	n/a
Example	PROT:CURRE:TRIP:CLE

<p>Command Syntax Description</p> <p>Parameters Parameter Format Example Query Format Returned Data Format Query Example</p>	<p>[SOURCE:]PEAK:CURRENT:LIMIT <nr2> This command set the user programmable peak current protection limit. (Not available in models with -413 Option).</p> <p>Peak current <nr2> PEAK:CURR:LIM 80.0</p> <p>[SOURCE:]PEAK:CURRENT:LIMIT? <nr2> PEAK:CURR? 80.0000</p>
<p>Query Syntax Description</p> <p>Returned Data Format Query Example</p>	<p>[SOURCE:]PEAK:CURRENT:LIMIT:MAXIMUM? This query command returns the maximum allowable setting for the user programmable peak current protection limit. (Not available in models with -413 Option).</p> <p><nr2> PEAK:CURR:LIM:MAX? 104.0000</p>
<p>Query Syntax Description</p> <p>Returned Data Format Query Example</p>	<p>[SOURCE:]PEAK:CURRENT:LIMIT:MINIMUM? This query command returns the minimum allowable setting for the user programmable peak current protection limit. (Not available in models with -413 Option).</p> <p><nr2> PEAK:CURR:LIM:MIN? 0.0000</p>
<p>Query Syntax Description</p> <p>Returned Data Format Query Example</p>	<p>[SOURCE:]PEAK:CURRENT:LIMIT:DEFAULT? This query command returns the default setting for the user programmable peak current protection limit. (Not available in models with -413 Option).</p> <p><nr2> PEAK:CURR:LIM:DEF? 104.0000</p>
<p>Command Syntax Description</p> <p>Parameters Parameter Format Example Query Format Returned Data Format Query Example</p>	<p>[SOURCE:]PROTECT:PEAK:CURRENT#[[:STATE]] <ON OFF> This command enables or disables the peak current protection function.</p> <p>< ON 1 OFF 0 > <cr> PROT:PEAK:CURR1 ON</p> <p>[SOURCE:]PROTECT:PEAK:CURRENT#[[:STATE]]? PROT:PEAK:CURR1? 1</p>

Command Syntax	[SOURCE:]PROTECT:PEAK:CURRENT#:LEVEL <LEVEL>
Description	This command sets the peak current protection level.
Parameters	< LEVEL >
Parameter Format	<nr2>
Example	PROT:PEAK:CURR1:LEV 95.0
Query Format	[SOURCE:]PROTECT:PEAK:CURRENT#:LEVEL?
Returned Data Format	
Query Example	PROT:PEAK:CURR1:LEV? 95.0000
Query Syntax	[SOURCE:]PROTECT:PEAK:CURRENT:LEVEL:MAXIMUM?
Description	This query command returns the maximum allowable setting for the peak current protection level.
Returned Data Format	<nr2>
Query Example	PROT:PEAK:CURR:LEV:MAX? 104.0000
Query Syntax	[SOURCE:]PROTECT:PEAK:CURRENT:LEVEL:MINIMUM?
Description	This query command returns the minimum allowable setting for the peak current protection level.
Returned Data Format	<nr2>
Query Example	PROT:PEAK:CURR:LEV:MIN? 104.0000
Query Syntax	[SOURCE:]PROTECT:PEAK:CURRENT:LEVEL:DEFAULT?
Description	This query command returns the default setting for the peak current protection level.
Returned Data Format	<nr2>
Query Example	PROT:PEAK:CURR:LEV:DEF? 104.0000
Query Syntax	[SOURCE:]PROTECT:PEAK:CURRENT:TRIPPED?
Description	This query command returns tripped state of the peak current protection level function. Return 1 if tripped, 0 if not.
Returned Data Format	
Query Example	PROT:PEAK:CURR:TRIP? 1
Command Syntax	[SOURCE:]PROTECT:PEAK:CURRENT:TRIPPED:CLEAR
Description	This command clears the peak current protection tripped status.
Parameters	None
Parameter Format	n/a
Example	PROT:PEAK:CURR:TRIP:CLE

8.7.11 Power Protection Programming Commands

Command Syntax	[SOURCE:]POWER:LIMit#
Description	This command sets the programmable true power limit level in kW for phase #. If # is omitted, all available phases are set to the value specified. The max available power for a phase can be obtained using the [SOURCE:]POWER:LIMit#:MAX? query command.
Parameters	Limit value in kW
Parameter Format	<nr2>
Example	POW:LIM 2.5
Query Format	[SOURCE:]POWER:LIMit#?
Returned Data Format	<nr2>
Query Example	POW:LIM1? 2.5000
Query Format	[SOURCE:]POWER:LIMit#:MAX?
Description	Returns maximum available true power capability for the specified phase # in kW. If # is omitted, returns maximum available power level for all phases. Typically, this value will be the same for all phases.
Returned Data Format	<nr2>
Query Example	POW:LIM1:MAX? 5.0000
Command Syntax	[SOURCE:]KVA:LIMit#
Description	This command sets the programmable apparent power limit level in kVA for phase #. If # is omitted, all available phases are set to the value specified. The max available apparent power for a phase can be obtained using the [SOURCE:]KVA:LIMit#:MAX? query command.
Parameters	Limit value in kVA
Parameter Format	<nr2>
Example	KVA:LIM 2.5
Query Format	[SOURCE:]KVA:LIMit#?
Returned Data Format	<nr2>
Query Example	POW:LIM1? 2.5000
Query Format	[SOURCE:]KVA:LIMit#:MAX?
Description	Returns maximum available apparent power capability for the specified phase # in kVA. If # is omitted, returns maximum available apparent power levels for all phases. Typically, this value will be the same for all phases.
Returned Data Format	<nr2>
Query Example	KVA:LIM1:MAX? 5.0000

Query Format Description	[SOURce:]MODE#? Returns protection mode for the selected phase # (# = 1, 2, or 3). If # is omitted, returns protection mode for all phases in comma separated format. Note: When the phase suffix is 1, 2 or 3 the possible return categories are from 0 to 4. With suffix is omitted, this command will return MIXED(5) if modes for each phase are not the same. For example, if in split phase mode phase A (suffix 1) is in VOLTAGE mode but phase B (suffix 2) is in CURRENT mode, the query SOUR:MODE? you will return MIXED: SOUR:MODE1? = VOLTAGE and SOUR:MODE2? = CURRENT -> SOUR:MODE? = MIXED If both or phases are set to the same mode, the actual mode will be returned: SOUR:MODE1? = VOLTAGE and SOUR:MODE2? = VOLTAGE -> SOUR:MODE? = VOLTAGE
Returned Data Format	<cr> Available protection modes: 0 = NONE 1 = VOLTAGE 2 = CURRENT 3 = POWER 4 = KVA 5 = MIXED
Query Example	SOUR:MODE? VOLTAGE, VOLTAGE, VOLTAGE
Command Syntax Description Parameters Parameter Format Example Query Format Returned Data Format Query Example	[SOURce:]PROTeCt[:RMS]:POWeR[:STATe] <ON OFF> This command turns the true power protection on or off. < 0 OFF 1 ON > <cr> PROT:POW ON [SOURce:]PROTeCt[:RMS]:POWeR[:STATe]? PROT:POW? 1
Command Syntax Description Parameters Parameter Format Example Query Format Returned Data Format Query Example	[SOURce:]PROTeCt[:RMS]:POWeR:LEVeL <LEVEL> This command sets the true power protection trip level. Setting is in KW. < LEVEL > <nr2> PROT:POW:LEV 5 [SOURce:]PROTeCt[:RMS]:POWeR:LEVeL? PROT:POW:LEV? 5.000

Query Syntax Description	[SOURCE:]PROTECT[:RMS]:POWER:LEVEL:MINimum? This command returns the minimum true power protection level setting.
Query Example	PROT:POW:LEV:MIN? 0.000
Query Syntax Description	[SOURCE:]PROTECT[:RMS]:POWER:LEVEL:MAXimum? This command returns the maximum true power protection level setting.
Query Example	PROT:POW:LEV:MAX? 41.667
Query Syntax Description	[SOURCE:]PROTECT[:RMS]:POWER:LEVEL:DEFault? This command returns the default true power protection level setting. This value will be a function of the power source model.
Query Example	PROT:POW:LEV:DEF? 41.667
Command Syntax Description	[SOURCE:]PROTECT[:RMS]:POWER:TDELAY <DELAY> This command sets the true power protection trip delay time. Setting is in multiples of 100 msec so 5 equals 500 msec.
Parameters	< LEVEL >
Parameter Format	<nr2>
Example	PROT:POW:LEV 5
Query Format	[SOURCE:]PROTECT[:RMS]:POWER:TDELAY?
Returned Data Format	
Query Example	PROT:POW:TDELAY? 5.000
Query Syntax Description	[SOURCE:]PROTECT[:RMS]:POWER:TDELAY:MINimum? This command returns the minimum true power protection trip delay time setting.
Query Example	PROT:POW: TDELAY:MIN? 0
Query Syntax Description	[SOURCE:]PROTECT[:RMS]:POWER:TDELAY:MAXimum? This command returns the maximum true power protection trip delay time setting.
Query Example	PROT:POW: TDELAY:MAX? 3000

<p>Query Syntax Description</p> <p>Query Example</p>	<p>[SOURCE:]PROTECT[:RMS]:POWER:TDELAY:DEFAULT? This command returns the default true power protection trip delay time setting.</p> <p>PROT:POW:TDELAY:DEF? 5</p>
<p>Query Syntax Description</p> <p>Query Example</p>	<p>[SOURCE:]PROTECT[:RMS]:POWER:TRIPPED? This command returns the true power protection trip status. Returns 1 if tripped or 0 if not.</p> <p>PROT:POW:TRIP? 41.667</p>
<p>Command Syntax Description</p> <p>Parameters Parameter Format Example</p>	<p>[SOURCE:]PROTECT[:RMS]:POWER:TRIPPED:CLEAR This command clears the true power protection trip status. Once cleared, the power source output can be enabled.</p> <p>None n/a PROT:POW:TRIP:CLE</p>
<p>Command Syntax Description Parameters Parameter Format Example Query Format Returned Data Format Query Example</p>	<p>[SOURCE:]PROTECT[:RMS]:KVA[:STATE] <ON OFF> This command turns the apparent power protection on or off.</p> <p>< 0 OFF 1 ON > <cr> PROT:POW ON</p> <p>[SOURCE:]PROTECT[:RMS]:KVA[:STATE]? PROT:KVA? 1</p>
<p>Command Syntax Description</p> <p>Parameters Parameter Format Example Query Format Returned Data Format Query Example</p>	<p>[SOURCE:]PROTECT[:RMS]:KVA:LEVEL <LEVEL> This command sets the apparent power protection trip level. Setting is in KW.</p> <p>< LEVEL > <nr2> PROT:POW:LEV 5</p> <p>[SOURCE:]PROTECT[:RMS]:KVA:LEVEL? PROT:KVA:LEV? 5.000</p>
<p>Query Syntax Description</p> <p>Query Example</p>	<p>[SOURCE:]PROTECT[:RMS]:KVA:LEVEL:MINIMUM? This command returns the minimum apparent power protection level setting.</p> <p>PROT:KVA:LEV:MIN? 0.000</p>

<p>Query Syntax Description</p> <p>Query Example</p>	<p>[SOURCE:]PROTECT[:RMS]:KVA:LEVEL:MAXimum? This command returns the maximum apparent power protection level setting.</p> <p>PROT:KVA:LEV:MAX? 41.667</p>
<p>Query Syntax Description</p> <p>Query Example</p>	<p>[SOURCE:]PROTECT[:RMS]:KVA:LEVEL:DEFAULT? This command returns the default apparent power protection level setting. This value will be a function of the power source model.</p> <p>PROT:KVA:LEV:DEF? 41.667</p>
<p>Command Syntax Description</p> <p>Parameters</p> <p>Parameter Format</p> <p>Example</p> <p>Query Format</p> <p>Returned Data Format</p> <p>Query Example</p>	<p>[SOURCE:]PROTECT[:RMS]:KVA:TDELAY <DELAY> This command sets the apparent power protection trip delay time. Setting is in multiples of 100 msec so 5 equals 500 msec.</p> <p>< LEVEL > <nr2> PROT:KVA:LEV 5</p> <p>[SOURCE:]PROTECT[:RMS]:KVA:TDELAY? PROT:KVA:TDELAY? 5.000</p>
<p>Query Syntax Description</p> <p>Query Example</p>	<p>[SOURCE:]PROTECT[:RMS]:KVA:TDELAY:MINimum? This command returns the minimum apparent power protection trip delay time setting.</p> <p>PROT:KVA: TDELAY:MIN? 0</p>
<p>Query Syntax Description</p> <p>Query Example</p>	<p>[SOURCE:]PROTECT[:RMS]:KVA:TDELAY:MAXimum? This command returns the maximum apparent power protection trip delay time setting.</p> <p>PROT:KVA: TDELAY:MAX? 3000</p>
<p>Query Syntax Description</p> <p>Query Example</p>	<p>[SOURCE:]PROTECT[:RMS]:KVA:TDELAY:DEFAULT? This command returns the default apparent power protection trip delay time setting.</p> <p>PROT:KVA:TDELAY:DEF? 5</p>
<p>Query Syntax Description</p> <p>Query Example</p>	<p>[SOURCE:]PROTECT[:RMS]:KVA:TRIPPed? This command returns the apparent power protection trip status. Returns 1 if tripped or 0 if not.</p> <p>PROT:KVA:TRIP? 41.667</p>

Command Syntax	[SOURCE:]PROTECT[:RMS]:KVA:TRIPPed:CLEar
Description	This command clears the apparent power protection trip status. Once cleared, the power source output can be enabled.
Parameters	None
Parameter Format	n/a
Example	PROT:KVA:TRIP:CLE

8.7.12 Frequency Protection Programming Commands

Command Syntax	[SOURCE:]PROTECT:RMS:UF#:LEVel <FREQ LEVEL>
Description	This command sets the under-frequency level. If the output frequency drops below the programmed level, an error is tripped.
Parameters	<VOLTAGE LEVEL>
Parameter Format	<nr2>
Example	PROT:RMS:UF1:LEV 45.0
Query Format	[SOURCE:]PROTECT:RMS:UF#:LEVel?
Returned Data Format	<nr2>
Query Example	PROT:RMSUV:LEV? 45.000

Command Syntax	[SOURCE:]PROTECT:RMS:UF#:STATE
Description	This command sets the under frequency level. If the output frequency drops below the programmed level, an error is tripped.
Parameters	< 0 1 >
Parameter Format	
Example	PROT:RMS:UV1:STAT 1
Query Format	[SOURCE:]PROTECT:RMS:UF#:STATE?
Returned Data Format	<nr1>
Query Example	PROT:RMS:UV1:STAT? 1

8.7.13 Impedance Programming Commands

These commands control the output impedance of the power source.

The programmable output impedance is defined by a resistive component (R) and inductive component (L).

Note: To enable the programmable impedance function, the output of the power source must be turned **OFF** first. Trying to enable this function while the output is ON will result in an error message.

Command Syntax	[SOURCE:]IMPEdance[:R]
Description	This command sets the Resistive value for the output impedance. Available programming range depends on the mode (Real-time or RMS).
Parameters	<R>
Parameter Format	<nr2>
Example	IMPED 0.2
Query Format	[SOURCE:]IMPEdance[:R]?
Returned Data Format	<nr2>
Query Example	IMPED:R? 0.200
Query Syntax	[SOURCE:]IMPEdance[:R][:LIMit]:MAXimum?
Description	This command return the maximum allowable setting value for the Resistive component of the output impedance.
Parameters	None
Parameter Format	N/A
Query Example	IMPED:R:MAX? 10.000
Query Syntax	[SOURCE:]IMPEdance[:R][:LIMit]:MINimum?
Description	This command return the minimum allowable setting value for the Resistive component of the output impedance.
Parameters	None
Parameter Format	N/A
Query Example	IMPED:R:MIN? -10.000

<p>Command Syntax Description</p>	<p>[SOURCE:]IMPEdance:L This command sets the Inductive value for the output impedance. Available programming range is -0.00000 ~ 0.002000 (Henry).</p>
<p>Parameters Parameter Format Example Query Format Returned Data Format Query Example</p>	<p><L> <nr2> IMPED:L 0.00002 [SOURCE:]IMPEdance:L? <nr2> IMPED:L? 0.002</p>
<p>Query Syntax Description</p>	<p>[SOURCE:]IMPEdance:L[:LIMit]:MAXimum? This command return the maximum allowable setting value for the Inductive component of the output impedance.</p>
<p>Parameters Parameter Format Query Example</p>	<p>None N/A IMPED:L:MAX? 0.002</p>
<p>Query Syntax Description</p>	<p>[SOURCE:]IMPEdance:L[:LIMit]:MINimum? This command return the minimum allowable setting value for the Inductive component of the output impedance.</p>
<p>Parameters Parameter Format Query Example</p>	<p>None N/A IMPED:L:MIN? 0.00000000</p>
<p>Command Syntax Description</p>	<p>[SOURCE:]IMPEdance:C This command sets the Capacitive value for the output impedance. Available programming range is -0.001 uF to 100.000 uF.</p>
<p>Parameters Parameter Format Example Query Format Returned Data Format Query Example</p>	<p><L> <nr2> IMPED:C 0.002 [SOURCE:]IMPEdance:C? <nr2> IMPED:C? 0.002</p>
<p>Query Syntax Description</p>	<p>[SOURCE:]IMPEdance:C[:LIMit]:MAXimum? This command return the maximum allowable setting value for the Capacitive component of the output impedance.</p>
<p>Parameters Parameter Format Query Example</p>	<p>None N/A IMPED:C:MAX? 0.1000</p>

Query Syntax Description	[SOURCE:]IMPEdance:C[:LIMit]:MINimum? This command return the minimum allowable setting value for the Capacitive component of the output impedance.
Parameters Parameter Format Query Example	None N/A IMPED:C:MIN? 0.00000001
Command Syntax Description	[SOURCE:]IMPEdance:MODE This command sets the programmable impedance mode to either Real-Time mode (0) or RMS Mode (1). See page 185 for a description of both impedance modes. 0 Real mode. 1 RMS mode. Note: To change programmable impedance modes, the output of the power source must be turned OFF first. Trying to change modes while the output is ON will result in an error message.
Parameters Parameter Format Example Query Format Returned Data Format Query Example	< 0 1 > IMPED:MODE 1 [SOURCE:]IMPEdance:MODE? IMPED:MODE? 1
Command Syntax Description	[SOURCE:]IMPEdance:STATe This command sets the programmable impedance state to either Off (0) or On (1). Note: To enable the programmable impedance function, the output of the power source must be turned OFF first. Trying to enable this function while the output is ON will result in an error message.
Parameters Parameter Format Example Query Format Returned Data Format Query Example	< 0 1 > IMPED:STAT 1 [SOURCE:]IMPEdance:STATe? IMPED:STAT? 1

8.7.14 STEP Transient Commands

The command in this section control STEP transients. Some of these commands have the option to specify NORMAL or SATurate.

SATurate mode: If a dwell time setting is out of limits, the dwell time will saturate to the limit min/max and it will not trip an error.

NORmal mode: If a dwell time setting is out of limits, an error will be generated and the dwell time setting will not be modified.

Command Syntax	[SOURCE:]STEP:MODE < INIDEL 0 FINDEL 1 INIFIN 2 >
Description	This command sets the programming mode for a STEP Transient. 0 INIDEL Allows programming the step by initial and delta values 1 FINDEL Allows programming the step by final and delta values 2 INIFIN Allows programming the step by initial and final values
Parameters	< INIDEL 0 FINDEL 1 INIFIN 2 >
Parameter Format	<cr> or <nr1>
Example	STEP:MODE 1
Query Format	[SOURCE:]STEP:MODE?
Returned Data Format	<nr1>
Query Example	STEP:MODE? 1

Query Syntax	[SOURCE:]STEP:MODE:CATalog?
Description	This command returns the available mode settings for a STEP Transient. 0 INIDEL Allows programming the step by initial and delta values 1 FINDEL Allows programming the step by final and delta values 2 INIFIN Allows programming the step by initial and final values
Returned Data Format	<nr1>
Query Example	STEP:MODE:CAT? 0,Initial and delta,1,Final and delta,2,Initial and final

Command Syntax	[SOURCE:]STEP:INITialvalue <OFF 0 ON 1>
Description	This command determines if an initial value step is inserted at the beginning of each repeat of a step transient. 0 ON Allows programming the step by initial and delta values 1 OFF Allows programming the step by final and delta values
Parameters	< OFF 0 ON 1 >
Parameter Format	<cr> or <nr1>
Example	STEP:INIT ON
Query Format	[SOURCE:]STEP:INITialvalue?
Returned Data Format	
Query Example	STEP:INIT? 1

The impact of inserting the initial value (ON) or not (OFF) is illustrated in the figure below.

- The top sequence shows a STEP transient repeated 3 times with STEP:INIT set ot OFF. The output will not return to the initial output setting between repetitions.
- The bottom sequence is the same STEP transient with STEP:INIT set to ON. Each repeat will start from the initial set value so each repititon produces the same output levels.

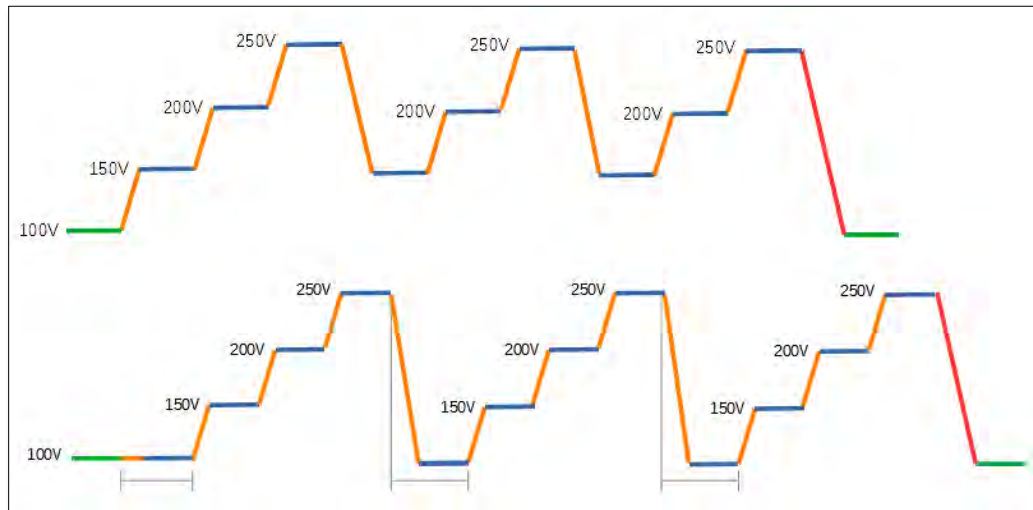

<p>Command Syntax</p> <p>Description</p> <p>Parameters</p> <p>Parameter Format</p> <p>Example</p> <p>Query Format</p> <p>Returned Data Format</p> <p>Query Example</p>	<p>[SOURCE:]STEP:DWELL <time>, <opt></p> <p>This command sets the dwell time of the step in seconds Minimum time set value allowed is 0.0002 sec. (0.2 msec)</p> <p>Time in seconds, Option: < NORmal SATurate > Default is NORmal if optional second parameter is omitted.</p> <p><nr2>, <cr></p> <p>STEP:MODE:DWELL 10, SAT</p> <p>[SOURCE:]STEP:MODE?</p> <p><nr2></p> <p>STEP:MODE:DWELL? 10.0000, SAT</p>
<p>Query Syntax</p> <p>Description</p> <p>Returned Data Format</p> <p>Query Example</p>	<p>[SOURCE:]STEP:DWELL:MINimum?</p> <p>This command returns lowest permissible set value for the STEP dwell time setting.</p> <p><nr2></p> <p>STEP:DWELL:MIN?</p> <p>Query return values for MINimum, MAXimum and DEFault are dependent on MODE and interdependent parameter value settings</p>
<p>Query Syntax</p> <p>Description</p> <p>Returned Data Format</p> <p>Query Example</p>	<p>[SOURCE:]STEP:DWELL:MAXimum?</p> <p>This command returns highest permissible set value for the STEP dwell time setting.</p> <p><nr2></p> <p>STEP:DWELL:MAX?</p> <p>Query return values for MINimum, MAXimum and DEFault are dependent on MODE and interdependent parameter value settings</p>

<p>Query Syntax Description</p> <p>Returned Data Format Query Example</p>	<p>[SOURCE:]STEP:DWELL:DEFault? This command returns default set value for the STEP dwell time setting.</p> <p><nr2> STEP:DWELL:DEF? 0.0998</p>
<p>Command Syntax Description</p> <p>Parameters</p> <p>Parameter Format Example</p> <p>Query Format Returned Data Format Query Example</p>	<p>[SOURCE:]STEP:RAMP <time>, <opt> This command sets the ramp time of the step in seconds Minimum time set value allowed is 0.0002 sec. (0.2 msec) Time in seconds, Option: < NORmal SATurate > Default is NORmal if optional second parameter is omitted.</p> <p><nr2>, <cr> STEP:MODE:RAMP 5, SAT</p> <p>[SOURCE:]STEP:RAMP? <nr2> STEP:RAMP? 5.0000, SAT</p>
<p>Query Syntax Description</p> <p>Returned Data Format Query Example</p>	<p>[SOURCE:]STEP:RAMP:MINimum? This command returns lowest permissible set value for the STEP ramp time setting.</p> <p><nr2> STEP:RAMP:MIN? Query return values for MINimum, MAXimum and DEFault are dependent on MODE and interdependent parameter value settings</p>
<p>Query Syntax Description</p> <p>Returned Data Format Query Example</p>	<p>[SOURCE:]STEP:RAMP:MAXimum? This command returns highest permissible set value for the STEP ramp time setting.</p> <p><nr2> STEP:RAMP:MAX? Query return values for MINimum, MAXimum and DEFault are dependent on MODE and interdependent parameter value settings</p>
<p>Query Syntax Description</p> <p>Returned Data Format Query Example</p>	<p>[SOURCE:]STEP:RAMP:DEFault? This command returns default set value for the STEP ramp time setting.</p> <p><nr2> STEP:RAMP:DEF? Query return values for MINimum, MAXimum and DEFault are dependent on MODE and interdependent parameter value settings</p>

<p>Command Syntax Description</p> <p>Parameters</p> <p>Parameter Format Example</p> <p>Query Format</p> <p>Returned Data Format</p> <p>Query Example</p>	<p>[SOURCE:]STEP:LENGth <time>, <opt></p> <p>This command sets the ramp time of the step in seconds Minimum time set value allowed is 0.0002 sec. (0.2 msec)</p> <p>Time in seconds, Option: < NORmal SATurate > Default is NORmal if optional second parameter is omitted.</p> <p><nr2>, <cr></p> <p>STEP:MODE:LENG 5, SAT</p> <p>[SOURCE:]STEP:LENGth?</p> <p><nr2></p> <p>STEP:LENG? 5.0000, SAT</p>
<p>Query Syntax Description</p> <p>Returned Data Format</p> <p>Query Example</p>	<p>[SOURCE:]STEP:LENGth:MINimum?</p> <p>This command returns lowest permissible set value for the STEP length time setting.</p> <p><nr2></p> <p>STEP:LENG:MIN?</p> <p>Query return values for MINimum, MAXimum and DEFault are dependent on MODE and interdependent parameter value settings</p>
<p>Query Syntax Description</p> <p>Returned Data Format</p> <p>Query Example</p>	<p>[SOURCE:]STEP:LENGth:MAXimum?</p> <p>This command returns highest permissible set value for the STEP length time setting.</p> <p><nr2></p> <p>STEP:LENG:MAX?</p> <p>Query return values for MINimum, MAXimum and DEFault are dependent on MODE and interdependent parameter value settings</p>
<p>Query Syntax Description</p> <p>Returned Data Format</p> <p>Query Example</p>	<p>[SOURCE:]STEP:LENGth:DEFault?</p> <p>This command returns default set value for the STEP length time setting.</p> <p><nr2></p> <p>STEP:LENG:DEF?</p> <p>Query return values for MINimum, MAXimum and DEFault are dependent on MODE and interdependent parameter value settings</p>
<p>Command Syntax Description</p> <p>Parameters</p> <p>Parameter Format Example</p> <p>Query Format</p> <p>Returned Data Format</p> <p>Query Example</p>	<p>[SOURCE:]STEP:REPeat <no, opt></p> <p>This command sets the number of repeat times for the ramp of the step</p> <p>No of repeats, Option: < NORmal SATurate > Default is NORmal if optional second parameter is omitted.</p> <p><nr1>, <cr></p> <p>STEP:MODE:REP 100</p> <p>[SOURCE:]STEP:REP?</p> <p><nr2></p> <p>STEP:REP? 100, NOR</p>

<p>Query Syntax Description</p> <p>Returned Data Format Query Example</p>	<p>[SOURCE:]STEP:REPeat:MINimum? This command returns lowest permissible set value for the STEP length time setting.</p> <p><nr1> STEP:REP:MIN? 0</p>
<p>Query Syntax Description</p> <p>Returned Data Format Query Example</p>	<p>[SOURCE:]STEP:REPeat:MAXimum? This command returns highest permissible set value for the STEP length time setting.</p> <p><nr1> STEP:REP:MAX? 65535</p>
<p>Query Syntax Description</p> <p>Returned Data Format Query Example</p>	<p>[SOURCE:]STEP:REPeat:DEFault? This command returns default set value for the STEP length time setting.</p> <p><nr2> STEP:REP:DEF? 1</p>
<p>Command Syntax Description Parameters</p> <p>Parameter Format Example</p> <p>Query Format Returned Data Format Query Example</p>	<p>[SOURCE:]STEP:COUNT <no, opt> This command sets the number of steps count. No of step count, Option: < NORmal SATurate > Default is NORmal if optional second parameter is omitted.</p> <p><nr1>, <cr> STEP:MODE:REP 12</p> <p>[SOURCE:]STEP:COUNT? <nr2> STEP:REP? 12, NOR</p>
<p>Query Syntax Description</p> <p>Returned Data Format Query Example</p>	<p>[SOURCE:]STEP:COUNT:MINimum? This command returns lowest permissible set value for the STEP count setting.</p> <p><nr1> STEP:COUNT:MIN? 1</p>
<p>Query Syntax Description</p> <p>Returned Data Format Query Example</p>	<p>[SOURCE:]STEP:COUNT:MAXimum? This command returns highest permissible set value for the STEP count setting.</p> <p><nr1> STEP:COUNT:MAX? 200</p>

Query Syntax	[SOURce:]STEP:COUNT:DEFault?
Description	This command returns default set value for the STEP count setting.
Returned Data Format	<nr2>
Query Example	STEP:COUNT:DEF? 10
Command Syntax	[SOURce:]STEP:HOLD < 0 OFF 1 ON >
Description	This command determines what happens to the source output after the step transient finishes. If ON, the last step value will be set as the steady state output when the step execution ends. If OFF, the output will revert to the original steady state setting in effect before the step transient execution.
Parameters	< 0 OFF 1 ON >
Parameter Format	<cr>
Example	STEP:HOLD ON
Query Format	[SOURce:]STEP:HOLD?
Returned Data Format	
Query Example	STEP:HOLD? 1
Command Syntax	[SOURce:]STEP:VOLTage[:AC][:iNITial]# < nr2 >, <cr> [SOURce:]STEP:VOLTage[:AC][:iNITial]#
Description	Voltage phase A, OPT: Voltage phase B, OPT: Voltage phase C, OPT This command sets the initial STEP voltage for selected phase # or for all phases if phase reference is omitted. Note: If you get the following error, check the STEP:MODE setting as the parameter you are trying to program is the depending one. Execution error: Not allowed command with the current configuration. Either set one of the othe STEP parameters or change the MODE. Note: If you get this error, check the min or max range for this parameter. Parameter above maximum unit scope.
Parameters	Voltage , < NORmal SATurate > Default is NORmal if optional second parameter is omitted.
Parameter Format	<nr2>, <cr>
Example	STEP:VOLT1 230.00, SAT
Query Format	[SOURce:]STEP:VOLTage[:AC][:iNITial]#?
Returned Data Format	<nr2> <nr2>, <nr2>, <nr2>
Query Example	STEP:VOLT1? 230.0000

Query Syntax Description	[SOURCE:]STEP:VOLTage[:AC][:INITial]#:MINimum? This command returns the minimum permissible set value for the initial STEP voltage for selected phase # or for all phases if phase reference is omitted
Returned Data Format Query Example	<nr2> STEP:VOLT1:MIN? Query return values for MINimum, MAXimum and DEFault are dependent on MODE and interdependent parameter value settings
Query Syntax Description	[SOURCE:]STEP:VOLTage[:AC][:INITial]#:MAXimum? This command returns the maximum permissible set value for the initial STEP voltage for selected phase # or for all phases if phase reference is omitted
Returned Data Format Query Example	<nr2> STEP:VOLT1:MAX? Query return values for MINimum, MAXimum and DEFault are dependent on MODE and interdependent parameter value settings
Query Syntax Description	[SOURCE:]STEP:VOLTage[:AC][:INITial]#:DEFault? This command returns the default set value for the initial STEP voltage for selected phase # or for all phases if phase reference is omitted
Returned Data Format Query Example	<nr2> STEP:VOLT1:DEF? Query return values for MINimum, MAXimum and DEFault are dependent on MODE and interdependent parameter value settings
Command Syntax	[SOURCE:]STEP:VOLTage[:AC]:FINal# < nr2 >, <cr> [SOURCE:]STEP:VOLTage[:AC]:FINal#
Description	Voltage phase A, OPT: Voltage phase B, OPT: Voltage phase C, OPT This command sets the final STEP voltage for selected phase # or for all phases if phase reference is omitted.
Parameters	Voltage , < NORmal SATurate > Default is NORmal if optional second parameter is omitted.
Parameter Format	<nr2>, <cr>
Example	STEP:VOLT:FIN 180.00, SAT
Query Format	[SOURCE:]STEP:VOLTage[:AC]:FINal#?
Returned Data Format	<nr2> <nr2>,<nr2>,<nr2>
Query Example	STEP:VOLT:FIN? 180.000,180.000,180.000

Query Syntax Description	[SOURCE:]STEP:VOLTage[:AC]:FINal#:MINimum? This command returns the minimum permissible set value for the final STEP voltage for selected phase # or for all phases if phase reference is omitted
Returned Data Format Query Example	<nr2> STEP:VOLT:FIN1:MIN? Query return values for MINimum, MAXimum and DEFault are dependent on MODE and interdependent parameter value settings
Query Syntax Description	[SOURCE:]STEP:VOLTage[:AC]:FINal#:MAXimum? This command returns the maximum permissible set value for the final STEP voltage for selected phase # or for all phases if phase reference is omitted
Returned Data Format Query Example	<nr2> STEP:VOLT:FIN1:MAX? Query return values for MINimum, MAXimum and DEFault are dependent on MODE and interdependent parameter value settings
Query Syntax Description	[SOURCE:]STEP:VOLTage[:AC]:FINal#:DEFault? This command returns the default set value for the final STEP voltage for selected phase # or for all phases if phase reference is omitted
Returned Data Format Query Example	<nr2> STEP:VOLT:FIN1:DEF? Query return values for MINimum, MAXimum and DEFault are dependent on MODE and interdependent parameter value settings
Command Syntax	[SOURCE:]STEP:VOLTage[:AC]:DELTA# < nr2 >, <cr> [SOURCE:]STEP:VOLTage[:AC]:DELTA#
Description	Voltage phase A, OPT: Voltage phase B, OPT: Voltage phase C, OPT This command sets the delta STEP voltage for selected phase # or for all phases if phase reference is omitted.
Parameters	Voltage , < NORmal SATurate > Default is NORmal if optional second parameter is omitted.
Parameter Format Example	<nr2>, <cr> STEP:VOLT:DELT1 10.00, SAT
Query Format	[SOURCE:]STEP:VOLTage[:AC]:DELTA#?
Returned Data Format	<nr2> <nr2>,<nr2>,<nr2>
Query Example	STEP:VOLT:DELT? 10.000,10.000,10.000

Query Syntax	[SOURCE:]STEP:VOLTage[:AC]:DELTA#:MINimum?
Description	This command returns the minimum permissible set value for the delta STEP voltage for selected phase # or for all phases if phase reference is omitted
Returned Data Format	<nr2>
Query Example	STEP:VOLT:DELT1:MIN? Query return values for MINimum, MAXimum and DEFault are dependent on MODE and interdependent parameter value settings
Query Syntax	[SOURCE:]STEP:VOLTage[:AC]:DELTA#:MAXimum?
Description	This command returns the maximum permissible set value for the delta STEP voltage for selected phase # or for all phases if phase reference is omitted
Returned Data Format	<nr2>
Query Example	STEP:VOLT:DELT1:MAX? Query return values for MINimum, MAXimum and DEFault are dependent on MODE and interdependent parameter value settings
Query Syntax	[SOURCE:]STEP:VOLTage[:AC]:DELTA#:DEFault?
Description	This command returns the default set value for the delta STEP voltage for selected phase # or for all phases if phase reference is omitted
Returned Data Format	<nr2>
Query Example	STEP:VOLT:DELT1:DEF? Query return values for MINimum, MAXimum and DEFault are dependent on MODE and interdependent parameter value settings
Command Syntax	[SOURCE:]STEP:VOLTage:DC[:INITial]# < nr2 >, <cr> [SOURCE:]STEP:VOLTage:DC[:INITial]#
Description	Voltage phase A, OPT: Voltage phase B, OPT: Voltage phase C, OPT This command sets the initial STEP DC voltage for selected phase # or for all phases if phase reference is omitted.
Parameters	Voltage , < NORmal SATurate > Default is NORmal if optional second parameter is omitted.
Parameter Format	<nr2>, <cr>
Example	STEP:VOLT:DC1 230.00, SAT
Query Format	[SOURCE:]STEP:VOLTage:DC[:INITial]#?
Returned Data Format	<nr2> <nr2>,<nr2>,<nr2>
Query Example	STEP:VOLT:DC? 0.000,0.000,0.000

Query Syntax Description	[SOURCE:]STEP:VOLTage:DC[:INITial]#:MINimum? This command returns the minimum permissible set value for the initial STEP DC voltage for selected phase # or for all phases if phase reference is omitted
Returned Data Format Query Example	<nr2> STEP:VOLT:DC1:MIN? Query return values for MINimum, MAXimum and DEFault are dependent on MODE and interdependent parameter value settings
Query Syntax Description	[SOURCE:]STEP:VOLTage:DC[:INITial]#:MAXimum? This command returns the maximum permissible set value for the initial STEP DC voltage for selected phase # or for all phases if phase reference is omitted
Returned Data Format Query Example	<nr2> STEP:VOLT:DC1:MAX? Query return values for MINimum, MAXimum and DEFault are dependent on MODE and interdependent parameter value settings
Query Syntax Description	[SOURCE:]STEP:VOLTage:DC[:INITial]#:DEFault? This command returns the default set value for the initial STEP DC voltage for selected phase # or for all phases if phase reference is omitted
Returned Data Format Query Example	<nr2> STEP:VOLT:DC1:DEF? Query return values for MINimum, MAXimum and DEFault are dependent on MODE and interdependent parameter value settings
Command Syntax	[SOURCE:]STEP:VOLTage:DC:FINal# < nr2 >, <cr> [SOURCE:]STEP:VOLTage:DC:FINal# Voltage phase A, OPT: Voltage phase B, OPT: Voltage phase C, OPT
Description	This command sets the final STEP DC voltage for selected phase # or for all phases if phase reference is omitted.
Parameters	Voltage , < NORmal SATurate > Default is NORmal if optional second parameter is omitted.
Parameter Format	<nr2>, <cr>
Example	STEP:VOLT:DC:FIN 187.00, SAT
Query Format	[SOURCE:]STEP:VOLTage:DC:FINal#?
Returned Data Format	<nr2> <nr2>,<nr2>,<nr2>
Query Example	STEP:VOLT:DC:FIN? 187.000,187.000,187.000

Query Syntax	[SOURCE:]STEP:VOLTage:DC:FINal#:MINimum?
Description	This command returns the minimum permissible set value for the final STEP DC voltage for selected phase # or for all phases if phase reference is omitted
Returned Data Format	<nr2>
Query Example	STEP:VOLT:DC:FIN1:MIN? Query return values for MINimum, MAXimum and DEFault are dependent on MODE and interdependent parameter value settings
Query Syntax	[SOURCE:]STEP:VOLTage:DC:FINal#:MAXimum?
Description	This command returns the maximum permissible set value for the final STEP DC voltage for selected phase # or for all phases if phase reference is omitted
Returned Data Format	<nr2>
Query Example	STEP:VOLT:DC:FIN1:MAX? Query return values for MINimum, MAXimum and DEFault are dependent on MODE and interdependent parameter value settings
Query Syntax	[SOURCE:]STEP:VOLTage:DC:FINal#:DEFault?
Description	This command returns the default set value for the final STEP DC voltage for selected phase # or for all phases if phase reference is omitted
Returned Data Format	<nr2>
Query Example	STEP:VOLT:DC:FIN1:DEF? Query return values for MINimum, MAXimum and DEFault are dependent on MODE and interdependent parameter value settings
Command Syntax	[SOURCE:]STEP:VOLTage:DC:DELTA# < nr2 >, <cr> [SOURCE:]STEP:VOLTage:DC:DELTA#
Description	Voltage phase A, OPT: Voltage phase B, OPT: Voltage phase C, OPT This command sets the delta STEP DC voltage for selected phase # or for all phases if phase reference is omitted.
Parameters	Voltage , < NORmal SATurate > Default is NORmal if optional second parameter is omitted.
Parameter Format	<nr2>, <cr>
Example	STEP:VOLT:DC:DELT1 10.00, SAT
Query Format	[SOURCE:]STEP:VOLTage:DC:DELTA#?
Returned Data Format	<nr2> <nr2>,<nr2>,<nr2>
Query Example	STEP:VOLT:DC:DELT? 10.0000

<p>Query Syntax Description</p>	<p>[SOURCE:]STEP:VOLTage:DC:DELTA#:MINimum? This command returns the minimum permissible set value for the delta STEP DC voltage for selected phase # or for all phases if phase reference is omitted</p>
<p>Returned Data Format Query Example</p>	<p><nr2> STEP:VOLT:DC:DELTA1:MIN? Query return values for MINimum, MAXimum and DEFault are dependent on MODE and interdependent parameter value settings</p>
<p>Query Syntax Description</p>	<p>[SOURCE:]STEP:VOLTage:DC:DELTA#:MAXimum? This command returns the maximum permissible set value for the delta STEP DC voltage for selected phase # or for all phases if phase reference is omitted</p>
<p>Returned Data Format Query Example</p>	<p><nr2> STEP:VOLT:DC:DELTA1:MAX? Query return values for MINimum, MAXimum and DEFault are dependent on MODE and interdependent parameter value settings</p>
<p>Query Syntax Description</p>	<p>[SOURCE:]STEP:VOLTage:DC:DELTA#:DEFault? This command returns the default set value for the delta STEP DC voltage for selected phase # or for all phases if phase reference is omitted</p>
<p>Returned Data Format Query Example</p>	<p><nr2> STEP:VOLT:DC:DELTA1:DEF? Query return values for MINimum, MAXimum and DEFault are dependent on MODE and interdependent parameter value settings</p>
<p>Command Syntax Description Parameters</p>	<p>[SOURCE:]STEP:FREQUENCY[:INITIAL] <nr2 >, <cr> This command sets the initial STEP frequency. Frequency, < NORMal SATurate > Default is NORMal if optional second parameter is omitted.</p>
<p>Parameter Format Example</p>	<p><nr2>, <cr> STEP:FREQ 50.0, SAT</p>
<p>Query Format Returned Data Format Query Example</p>	<p>[SOURCE:]STEP:FREQUENCY[:INITIAL]? <nr2> STEP:FREQ? 50.0000</p>
<p>Query Syntax Description</p>	<p>[SOURCE:]STEP:FREQUENCY[:INITIAL]:MINimum? This command returns the minimum permissible set value for the initial STEP frequency.</p>
<p>Returned Data Format Query Example</p>	<p><nr2> STEP:FREQ:MIN? Query return values for MINimum, MAXimum and DEFault are dependent on MODE and interdependent parameter value settings</p>

<p>Query Syntax Description</p> <p>Returned Data Format Query Example</p>	<p>[SOURCE:]STEP:FREQUENCY[:INITIAL]:MAXIMUM? This command returns the maximum permissible set value for the initial STEP frequency.</p> <p><nr2> STEP:FREQ:MAX? Query return values for MINimum, MAXimum and DEFault are dependent on MODE and interdependent parameter value settings</p>
<p>Query Syntax Description</p> <p>Returned Data Format Query Example</p>	<p>[SOURCE:]STEP:FREQUENCY[:INITIAL]:DEFAULT? This command returns the default set value for the initial STEP frequency.</p> <p><nr2> STEP:FREQ:DEF? Query return values for MINimum, MAXimum and DEFault are dependent on MODE and interdependent parameter value settings</p>
<p>Command Syntax Description Parameters</p> <p>Parameter Format Example</p> <p>Query Format Returned Data Format Query Example</p>	<p>[SOURCE:]STEP:FREQUENCY:FINAL <nr2 >, <cr> This command sets the final STEP frequency. Frequency, < NORMAL SATurate > Default is NORMAL if optional second parameter is omitted.</p> <p><nr2>, <cr> STEP:FREQ:FIN 55.0, SAT</p> <p>[SOURCE:]STEP:FREQUENCY:FINAL? <nr2> STEP:FREQ:FIN? 55.0000</p>
<p>Query Syntax Description</p> <p>Returned Data Format Query Example</p>	<p>[SOURCE:]STEP:FREQUENCY:FINAL:MINIMUM? This command returns the minimum permissible set value for the final STEP frequency.</p> <p><nr2> STEP:FREQ:FIN:MIN? 15.0000</p>
<p>Query Syntax Description</p> <p>Returned Data Format Query Example</p>	<p>[SOURCE:]STEP:FREQUENCY:FINAL:MAXIMUM? This command returns the maximum permissible set value for the final STEP frequency.</p> <p><nr2> STEP:FREQ:FIN:MAX? 1000.0000</p>

<p>Query Syntax Description</p> <p>Returned Data Format Query Example</p>	<p>[SOURCE:]STEP:FREQUENCY:FINAl:DEFault? This command returns the default set value for the final STEP frequency.</p> <p><nr2> STEP:FREQ:FIN:DEF? 60.0000</p>
<p>Command Syntax Description Parameters</p> <p>Parameter Format Example Query Format Returned Data Format Query Example</p>	<p>[SOURCE:]STEP:FREQUENCY:DELTA <nr2 >, <cr> This command sets the delta frequency. Frequency, < NORmal SATurate > Default is NORmal if optional second parameter is omitted.</p> <p><nr2>, <cr> STEP:FREQ:DELT 5.0, SAT</p> <p>[SOURCE:]STEP:FREQUENCY:DELTA? <nr2> STEP:FREQ:DELT? 5.0000</p>
<p>Query Syntax Description</p> <p>Returned Data Format Query Example</p>	<p>[SOURCE:]STEP:FREQUENCY:DELTA:MINimum? This command returns the minimum permissible set value for the delta STEP frequency.</p> <p><nr2> STEP:FREQ:DELT:MIN? Query return values for MINimum, MAXimum and DEFault are dependent on MODE and interdependent parameter value settings</p>
<p>Query Syntax Description</p> <p>Returned Data Format Query Example</p>	<p>[SOURCE:]STEP:FREQUENCY:DELTA:MAXimum? This command returns the maximum permissible set value for the delta STEP frequency.</p> <p><nr2> STEP:FREQ:DELT:MAX? Query return values for MINimum, MAXimum and DEFault are dependent on MODE and interdependent parameter value settings</p>
<p>Query Syntax Description</p> <p>Returned Data Format Query Example</p>	<p>[SOURCE:]STEP:FREQUENCY:DELTA:DEFault? This command returns the default set value for the delta STEP frequency.</p> <p><nr2> STEP:FREQ:DELT:DEF? Query return values for MINimum, MAXimum and DEFault are dependent on MODE and interdependent parameter value settings</p>

<p>Command Syntax Description</p>	<p>[SOURCE:]STEP:WAVEFORM# <nr1 > This command sets the selected waveform using the waveform number.</p>
<p>Parameters</p>	Waveform number
<p>Parameter Format</p>	<nr1>, <cr>
<p>Example</p>	STEP:WAVEFORM 1
<p>Query Format</p>	[SOURCE:]STEP:WAVEFORM#?
<p>Returned Data Format</p>	<nr1>
<p>Query Example</p>	STEP:WAVEFORM#? 1.0000
<p>Query Syntax Description</p>	<p>[SOURCE:]STEP:WAVEFORM#:MINimum? This command returns the minimum permissible set value for the STEP waveform.</p>
<p>Returned Data Format</p>	<nr1>
<p>Query Example</p>	STEP:WAVEFORM#:MIN? 1
<p>Query Syntax Description</p>	<p>[SOURCE:]STEP:WAVEFORM#:MAXimum? This command returns the maximum permissible set value for the STEP waveform.</p>
<p>Returned Data Format</p>	<nr1>
<p>Query Example</p>	STEP:WAVEFORM#:MAX? 200
<p>Query Syntax Description</p>	<p>[SOURCE:]STEP:WAVEFORM:DEFault? This command returns the default set value for the STEP waveform.</p>
<p>Returned Data Format</p>	<nr1>
<p>Query Example</p>	STEP:WAVEFORM:DEF? 1
<p>Command Syntax Description</p>	<p>[SOURCE:]STEP:PHASE[:INITial]# < nr2 >, <cr> This command sets the initial STEP phase angle for selected phase # number. Only phase 1 (B) and 2 (C) are allowed.</p>
<p>Parameters</p>	Phase No., < NORmal SATurate > Default is NORmal if optional second parameter is omitted.
<p>Parameter Format</p>	<nr1>, <cr>
<p>Example</p>	STEP:PHAS1 245.0
<p>Query Format</p>	[SOURCE:]STEP:PHASE[:INITial]#?
<p>Returned Data Format</p>	<nr1>, <cr>
<p>Query Example</p>	STEP:PHAS1? 245.0000

<p>Query Syntax Description</p> <p>Returned Data Format Query Example</p>	<p>[SOURCE:]STEP:PHASE[:INITIAL]#:MINIMUM? This command returns the minimum permissible set value of the initial STEP phase angle for selected phase #</p> <p><nr1> STEP:PHAS1:MIN? Query return values for MINimum, MAXimum and DEFault are dependent on MODE and interdependent parameter value settings</p>
<p>Query Syntax Description</p> <p>Returned Data Format Query Example</p>	<p>[SOURCE:]STEP:PHASE[:INITIAL]#:MAXIMUM? This command returns the maximum permissible set value of the initial STEP phase angle for selected phase #</p> <p><nr1> STEP:PHAS1:MAX? Query return values for MINimum, MAXimum and DEFault are dependent on MODE and interdependent parameter value settings</p>
<p>Query Syntax Description</p> <p>Returned Data Format Query Example</p>	<p>[SOURCE:]STEP:PHASE[:INITIAL]#:DEF? This command returns the default set value of the initial STEP phase angle for selected phase #</p> <p><nr1> Query return values for MINimum, MAXimum and DEFault are dependent on MODE and interdependent parameter value settings</p>
<p>Command Syntax Description</p> <p>Parameters</p> <p>Parameter Format Example</p> <p>Query Format Returned Data Format Query Example</p>	<p>[SOURCE:]STEP:PHASE:FINAL# < nr2 >, <cr> This command sets the final STEP phase angle for selected phase # number. Only phase 1 (B) and 2 (C) are allowed. Phase No., < NORmal SATurate > Default is NORmal if optional second parameter is omitted.</p> <p><nr2>, <cr> STEP:PHAS:FIN1 240.0</p> <p>[SOURCE:]STEP:PHASE:FINAL#? <nr2> STEP:PHAS:FIN1? 240.0000</p>
<p>Query Syntax Description</p> <p>Returned Data Format Query Example</p>	<p>[SOURCE:]STEP:PHASE:FINAL#:MINIMUM? This command returns the minimum permissible set value of the final STEP phase angle for selected phase #</p> <p><nr1> STEP:PHAS:FIN1:MIN? Query return values for MINimum, MAXimum and DEFault are dependent on MODE and interdependent parameter value settings</p>

<p>Query Syntax Description</p> <p>Returned Data Format Query Example</p>	<p>[SOURCE:]STEP:PHASE:FINal#:MAXimum?</p> <p>This command returns the maximum permissible set value of the final STEP phase angle for selected phase #</p> <p><nr1></p> <p>STEP:PHAS:FIN1:MAX?</p> <p>Query return values for MINimum, MAXimum and DEFault are dependent on MODE and interdependent parameter value settings</p>
<p>Query Syntax Description</p> <p>Returned Data Format Query Example</p>	<p>[SOURCE:]STEP:PHASE:FINal#:DEF?</p> <p>This command returns the default set value of the final STEP phase angle for selected phase #</p> <p><nr1></p> <p>STEP:PHAS:FIN1:DEF?</p> <p>Query return values for MINimum, MAXimum and DEFault are dependent on MODE and interdependent parameter value settings</p>
<p>Command Syntax Description</p> <p>Parameters</p> <p>Parameter Format Example</p> <p>Query Format</p> <p>Returned Data Format Query Example</p>	<p>[SOURCE:]STEP:PHASE:DELTA# < nr2 >, <cr></p> <p>This command sets the delta STEP phase angle for selected phase # number. Only phase 1 (B) and 2 (C) are allowed.</p> <p>Phase No., < NORmal SATurate ></p> <p>Default is NORmal if optional second parameter is omitted.</p> <p><nr1>, <cr></p> <p>STEP:PHAS:DELT1 240.0</p> <p>[SOURCE:]STEP:PHASE:DELTA#?</p> <p><nr1>, <cr></p> <p>STEP:PHAS:DELT1?</p> <p>240.0000</p>
<p>Query Syntax Description</p> <p>Returned Data Format Query Example</p>	<p>[SOURCE:]STEP:PHASE:DELTA#:MINimum?</p> <p>This command returns the minimum permissible set value of the delta STEP phase angle for selected phase #</p> <p><nr1></p> <p>STEP:PHAS:DELT1:MIN?</p> <p>Query return values for MINimum, MAXimum and DEFault are dependent on MODE and interdependent parameter value settings</p>
<p>Query Syntax Description</p> <p>Returned Data Format Query Example</p>	<p>[SOURCE:]STEP:PHASE:DELTA#:MAXimum?</p> <p>This command returns the maximum permissible set value of the delta STEP phase angle for selected phase #</p> <p><nr1></p> <p>STEP:PHAS:DELT1:MAX?</p> <p>Query return values for MINimum, MAXimum and DEFault are dependent on MODE and interdependent parameter value settings</p>

Query Syntax	[SOURCE:]STEP:PHASE:DELTA#:DEF?
Description	This command returns the default set value of the delta STEP phase angle for selected phase #
Returned Data Format	<nr1>
Query Example	Query return values for MINimum, MAXimum and DEFault are dependent on MODE and interdependent parameter value settings
Command Syntax	[SOURCE:]STEP <cr> >>> <i>Alias for PROGRAM:TRANSient command.</i> <<<
Description	This command controls step transient execution
Parameters	< RUN STOP PAUSE STEP RESTart >
Parameter Format	<cr>
Example	STEP RUN
Query Format	[SOURCE:]STEP?
Description	Query format returns the step transient execution state as either RUN, STOP, PAUS, STEP or REST
Returned Data Format	<nr1> Return values represent running state as follows:
	0 Stopped
	1 Running
	2 Paused
	3 Stepping
	4 Waiting for trigger
Query Example	STEP? 1
Command Syntax	[SOURCE:]STEP:LOAD
Description	This command converts the step transient definition to the power source's regular transient segment format and loads it in the controller real-time memory for execution.
Parameters	None
Parameter Format	n/a
Example	STEP RUN
Query Format	[SOURCE:]STEP:LOAD?
Description	Query format returns a 1 if the step transient load operation was successful, otherwise returns 0.
Returned Data Format	<nr1> Return values represent:
	0 Load Failed
	1 Load completed
Query Example	STEP? 1

Query Syntax **[SOURCE:]STEP:PROGRESS?**
 >>> *Alias for PROGRAM:TRANSIENT:PROGRESS command.* <<<

Description This query command returns the status of the step being executed.

Parameters None

Parameter Format n/a

Description Query returns the step transient execution state as either RUN, STOP, PAUS, STEP or REST

Returned Data Format <cr>

 The response is a comma-separated value string representing:
 PROGRESS, CURRENT SEGMENT PROGRESS, CURRENT SEGMENT, CURRENT
 SEGMENT TIME, TOTAL TIME, TOTAL SEGMENTS, REPEAT TIME COUNTER

Query Example STEP:PROG?
 1, 45, 2, 1.2300, 2.0000, 4, 5

Query Syntax **[SOURCE:]STEP:CHECK?**

Description This query command returns the result of a check on the programmed step parameters to determine if they are ok to run.

Parameters None

Parameter Format n/a

Description Query returns result of STEP parameters integrity check

Returned Data Format <cr>

 The response is either OK or if not, a string containing the error.

Query Example STEP:PROG?
 OK

Query Syntax **[SOURCE:]STEP:ALL?**

Description This query command returns a comma-separated values string of the entire step parameters, settings, and limits. Each set value is preceded by a tag identifying the parameter. This same data structure is used for front panel display and by the web server. The advantage is that this commands returns all step related information using just one query command.

Parameters None

Parameter Format n/a

Description Returns complete STEP setup as a comma separated value string.

Returned Data Format <cr>

Query Example STEP:ALL?

form,3,loaded,0,status,0,progress,0,current element progress,0,current element,0,current element time,0,total time,0,total elements,0,repeat times,0,hold,1,init,1,mode,0,mode max,2,mode min,0,dwell,0,dwell max,10000,dwell min,0,ramp,0,ramp max,10000,ramp min,0,length,0,length max,10000,length min,0,repeat,1,repeat max,65535,repeat min,0,count,10,count max,200,count min,1,count min reason,0,count max reason,0,waveform all,1,waveform all exist,1,waveform a,1,waveform a exist,1,waveform b,1,waveform b exist,1,waveform c,1,waveform c exist,1,waveform max,200,waveform min,1,initial frequency,0.0000,initial frequency min,0.0000,initial frequency max,0.0000,initial frequency min reason,4,initial frequency max reason,4,initial voltage ac all,0.0000,initial voltage ac all max,0.0000,initial voltage ac all min,0.0000,initial voltage ac all max reason,4,initial voltage ac all min reason,4,initial voltage ac a,0.0000,initial voltage ac a max,0.0000,initial voltage ac a min,0.0000,initial voltage ac a max reason,4,initial voltage ac a min reason,4,initial voltage ac b,0.0000,initial voltage ac b max,0.0000,initial voltage ac b min,0.0000,initial voltage ac b max reason,4,initial voltage ac b min reason,4,initial voltage ac c,0.0000,initial voltage ac c max,0.0000,initial voltage ac c min,0.0000,initial voltage ac c max reason,4,initial voltage ac c min reason,4,initial voltage dc all,0.0000,initial voltage dc all max,425.0000,initial voltage dc all min,-425.0000,initial voltage dc all max reason,0,initial voltage dc all min reason,0,initial voltage dc a,0.0000,initial voltage dc a max,425.0000,initial voltage dc a min,-425.0000,initial voltage dc a max reason,0,initial voltage dc a min reason,0,initial voltage dc b,0.0000,initial

voltage dc b max,425.0000,initial voltage dc b min,-425.0000,initial voltage dc b max reason,0,initial voltage dc b min reason,0,initial voltage dc c,0.0000,initial voltage dc c max,425.0000,initial voltage dc c min,-425.0000,initial voltage dc c max reason,0,initial voltage dc c min reason,0,initial phase b,120.0000,initial phase c,240.0000,initial phase max,99999.0000,initial phase min,-99999.0000,final frequency,0.0000,final frequency min,0.0000,final frequency max,0.0000,final frequency min reason,4,final frequency max reason,4,final voltage ac all,0.0000,final voltage ac all max,0.0000,final voltage ac all min,0.0000,final voltage ac all max reason,4,final voltage ac all min reason,4,final voltage ac a,0.0000,final voltage ac a max,0.0000,final voltage ac a min,0.0000,final voltage ac a max reason,4,final voltage ac a min reason,4,final voltage ac b,0.0000,final voltage ac b max,0.0000,final voltage ac b min,0.0000,final voltage ac b max reason,4,final voltage ac b min reason,4,final voltage ac c,0.0000,final voltage ac c max,0.0000,final voltage ac c min,0.0000,final voltage ac c max reason,4,final voltage ac c min reason,4,final voltage dc all,0.0000,final voltage dc all max,425.0000,final voltage dc all min,-425.0000,final voltage dc all max reason,0,final voltage dc all min reason,0,final voltage dc a,0.0000,final voltage dc a max,425.0000,final voltage dc a min,-425.0000,final voltage dc a max reason,0,final voltage dc a min reason,0,final voltage dc b,0.0000,final voltage dc b max,425.0000,final voltage dc b min,-425.0000,final voltage dc b max reason,0,final voltage dc b min reason,0,final voltage dc c,0.0000,final voltage dc c max,425.0000,final voltage dc c min,-425.0000,final voltage dc c max reason,0,final voltage dc c min reason,0,final phase b,120.0000,final phase c,240.0000,final phase max,99999.0000,final phase min,-99999.0000,delta frequency,0.0000,delta frequency min,0.0000,delta frequency max,0.0000,delta frequency min reason,4,delta frequency max reason,4,delta voltage ac all,0.0000,delta voltage ac all max,0.0000,delta voltage ac all min,0.0000,delta voltage ac all max reason,4,delta voltage ac all min reason,4,delta voltage ac a,0.0000,delta voltage ac a max,0.0000,delta voltage ac a min,0.0000,delta voltage ac a max reason,4,delta voltage ac a min reason,4,delta voltage ac b,0.0000,delta voltage ac b max,0.0000,delta voltage ac b min,0.0000,delta voltage ac b max reason,4,delta voltage ac b min reason,4,delta voltage ac c,0.0000,delta voltage ac c max,0.0000,delta voltage ac c min,0.0000,delta voltage ac c max reason,4,delta voltage ac c min reason,4,delta voltage dc all,0.0000,delta voltage dc all max,42.5000,delta voltage dc all min,-42.5000,delta voltage dc all max reason,0,delta voltage dc all min reason,0,delta voltage dc a,0.0000,delta voltage dc a max,42.5000,delta voltage dc a min,-42.5000,delta voltage dc a max reason,0,delta voltage dc a min reason,0,delta voltage dc b,0.0000,delta voltage dc b max,42.5000,delta voltage dc b min,-42.5000,delta voltage dc b max reason,0,delta voltage dc b min reason,0,delta voltage dc c,0.0000,delta voltage dc c max,42.5000,delta voltage dc c min,-42.5000,delta voltage dc c max reason,0,delta voltage dc c min reason,0,delta phase b,0.0000,delta phase c,0.0000,delta phase max,99999.0000,delta phase min,-99999.0000

8.7.15 PULSE Transient Commands

The command in this section control PULSE transients. Some of these commands have the option to specify NORMAL or SATurate.

- SATurate mode:** If a dwell time setting is out of limits, the dwell time will saturate to the limit min/max and it will not trip an error.
- NORMAL mode:** If a dwell time setting is out of limits, an error will be generated and the dwell time setting will not be modified.

Command Syntax	[SOURCE:]PULSE:COUNT <nr1>, <opt>
Description	This command sets the pulse count or the number of pulses to execute. Minimum time set value allowed is 1.
Parameters	Count, Option: < NORMAL SATurate > Default is NORMAL if optional second parameter is omitted.
Parameter Format	<nr1>, <cr>
Example	PULSE:COUNT 5
Query Format	[SOURCE:]PULSE:COUNT?
Returned Data Format	<nr1>
Query Example	PULSE:COUNT? 5.0000

<p>Query Syntax Description</p> <p>Returned Data Format Query Example</p>	<p>[SOURCE:]PULSE:COUNT:MINimum? This command returns the minimum permissible set value for the PULSE count.</p> <p><nr1> PULS:COUNT:MIN? 0</p>
<p>Query Syntax Description</p> <p>Returned Data Format Query Example</p>	<p>[SOURCE:]PULSE:COUNT:MAXimum? This command returns the maximum permissible set value for the PULSE count.</p> <p><nr1> PULS:COUNT:MAX? 65535</p>
<p>Query Syntax Description</p> <p>Returned Data Format Query Example</p>	<p>[SOURCE:]PULSE:COUNT:DEFault? This command returns the default set value for the PULSE count.</p> <p><nr1> PULS:COUNT:DEF? 1</p>
<p>Command Syntax Description</p> <p>Parameters</p> <p>Parameter Format Example</p> <p>Query Format Returned Data Format Query Example</p>	<p>[SOURCE:]PULSE:DCYcle <nr1>, <opt> This command sets the pulse duty cycle in percent. Minimum set value allowed is 1, max is 99.</p> <p>Duty Cycle %, Option: < NORmal SATurate > Default is NORmal if optional second parameter is omitted.</p> <p><nr1>, <cr> PULS:DCYC 50</p> <p>[SOURCE:]PULSE:DCYcle? <nr1> PULS:DCYC? 50.0000</p>
<p>Query Syntax Description</p> <p>Returned Data Format Query Example</p>	<p>[SOURCE:]PULSE:DCYcle:MINimum? This command returns the minimum permissible set value for the PULSE duty cycle.</p> <p><nr2> PULS:DCYC:MIN? 0.0000</p>
<p>Query Syntax Description</p> <p>Returned Data Format Query Example</p>	<p>[SOURCE:]PULSE:DCYcle:MAXimum? This command returns the maximum permissible set value for the PULSE duty cycle.</p> <p><nr2> PULS:DCYC:MAX? 100.0000</p>

<p>Query Syntax Description Returned Data Format Query Example</p>	<p>[SOURCE:]PULSE:DCYCLE:DEFAULT? This command returns the default set value for the PULSE duty cycle. <nr2> PULS:DCYC:DEF? 50.0000</p>
<p>Command Syntax Description Parameters Parameter Format Example Query Format Returned Data Format Query Example</p>	<p>[SOURCE:]PULSE:PERIOD <nr2>, <opt> This command sets the pulse period in seconds. Period, Option: < NORMAL SATurate > Default is NORMAL if optional second parameter is omitted. <nr2>, <cr> PULS:PER 12.8 [SOURCE:]PULSE:PERIOD? <nr2> PULS:PER? 12.8000</p>
<p>Query Syntax Description Returned Data Format Query Example</p>	<p>[SOURCE:]PULSE:PERIOD:MINIMUM? This command returns the minimum permissible set value for the PULSE period setting. <nr2> PULS:PER:MIN? Query return values for MINimum, MAXimum and DEFAULT are dependent on MODE and interdependent parameter value settings</p>
<p>Query Syntax Description Returned Data Format Query Example</p>	<p>[SOURCE:]PULSE:PERIOD:MAXIMUM? This command returns the maximum permissible set value for the PULSE period. <nr2> PULS:PER:MAX? Query return values for MINimum, MAXimum and DEFAULT are dependent on MODE and interdependent parameter value settings</p>
<p>Query Syntax Description Returned Data Format Query Example</p>	<p>[SOURCE:]PULSE:PERIOD:DEFAULT? This command returns the default set value for the PULSE period. <nr2> PULS:PER:DEF? Query return values for MINimum, MAXimum and DEFAULT are dependent on MODE and interdependent parameter value settings</p>

<p>Command Syntax Description Parameters</p>	<p>[SOURCE:]PULSE:WIDTH <nr2>, <opt> This command sets the pulse width in seconds. Width, Option: < NORmal SATurate > Default is NORmal if optional second parameter is omitted.</p>
<p>Parameter Format Example Query Format Returned Data Format Query Example</p>	<p><nr2>, <cr> PULS:WIDT 25.6 [SOURCE:]PULSE:WIDTH? <nr2> PULS:WIDT? 25.6000</p>
<p>Query Syntax Description</p>	<p>[SOURCE:]PULSE:WIDTH:MINimum? This command returns the minimum permissible set value for the PULSE width.</p>
<p>Returned Data Format Query Example</p>	<p><nr2> PULS:WIDT:MIN? Query return values for MINimum, MAXimum and DEFault are dependent on MODE and interdependent parameter value settings</p>
<p>Query Syntax Description</p>	<p>[SOURCE:]PULSE:WIDTH:MAXimum? This command the returns maximum permissible set value for the PULSE width.</p>
<p>Returned Data Format Query Example</p>	<p><nr2> PULS:WIDT:MAX? Query return values for MINimum, MAXimum and DEFault are dependent on MODE and interdependent parameter value settings</p>
<p>Query Syntax Description Returned Data Format Query Example</p>	<p>[SOURCE:]PULSE:WIDTH:DEFault? This command returns the default set value for the PULSE width.</p>
<p>Returned Data Format Query Example</p>	<p><nr2> PULS:WIDT:DEF? Query return values for MINimum, MAXimum and DEFault are dependent on MODE and interdependent parameter value settings</p>
<p>Command Syntax Description Parameters</p>	<p>[SOURCE:]PULSE:MODE <nr2>, <opt> This command sets the pulse width in seconds. < 0 PW 1 PD 2 WD > Encoding:</p>
<p>Parameter Format Example Query Format Returned Data Format Query Example</p>	<p>0 PW program pulse by period and width 1 PD program pulse by period and duty cycle 2 WD program pulse by width and duty cycle <nr1> or <cr> PULS:MODE WD [SOURCE:]PULSE:MODE? <nr1> PULS:MODE? 2</p>

Query Syntax **[SOURCE:]PULSE:MODE:CATalog?**
 Description This command returns the available programming modes: "0,Period and width,1,Period and duty cycle,2,Width and duty cycle".
 Parameters None
 Returned Data Format <cr>
 Query Example PULS:MODE:CAT?
 0,Period and width,1,Period and duty cycle,2,Width and duty cycle

Command Syntax **[SOURCE:]PULSE:RAMP <nr2>, <opt>**
 Description This command sets the pulse ramp time in seconds.
 Parameters Ramp time, Option: < NORmal | SATurate >
 Default is NORmal if optional second parameter is omitted.
 Parameter Format <nr2>, <cr>
 Example PULS:RAMP 0.2
 Query Format **[SOURCE:]PULSE:RAMP?**
 Returned Data Format <nr2>
 Query Example PULS:RAMP?
 0.2

Query Syntax **[SOURCE:]PULSE:RAMP:MINimum?**
 Description This command returns the minimum permissible set value for the PULSE ramp time.
 Returned Data Format <nr2>
 Query Example PULS:RAMP:MIN?
 Query return values for MINimum, MAXimum and DEFault are dependent on MODE and interdependent parameter value settings

Query Syntax **[SOURCE:]PULSE:RAMP:MAXimum?**
 Description This command returns the maximum permissible set value for the PULSE ramp time.
 Returned Data Format <nr2>
 Query Example PULS:RAMP:MAX?
 Query return values for MINimum, MAXimum and DEFault are dependent on MODE and interdependent parameter value settings

Query Syntax **[SOURCE:]PULSE:RAMP:DEFault?**
 Description This command returns the default setting for the PULSE ramp time.
 Returned Data Format <nr2>
 Query Example PULS:RAMP:DEF?
 Query return values for MINimum, MAXimum and DEFault are dependent on MODE and interdependent parameter value settings

Command Syntax	[SOURce:]PULSe:VOLTage[:AC]# < nr2 >, <cr> [SOURce:]PULSe:VOLTage[:AC] #
Description	Voltage phase A, OPT: Voltage phase B, OPT: Voltage phase C, OPT This command sets the PULSE voltage for selected phase # or for all phases if phase reference is omitted.
Parameters	Voltage , < NORmal SATurate > Default is NORmal if optional second parameter is omitted.
Parameter Format	<nr2>, <cr>
Example	PULS:VOLT1 230.00, SAT
Query Format	[SOURce:]PULSe:VOLTage[:AC]#?
Returned Data Format	<nr2>
Query Example	PULS:VOLT1? 230.0000
Query Syntax	[SOURce:]PULSe:VOLTage[:AC]#:MINimum?
Description	This command returns the minimum permissible set value for the PULSE voltage for selected phase # or for all phases if phase reference is omitted
Returned Data Format	<nr2>
Query Example	PULS:VOLT1:MIN? 0.0000
Query Syntax	[SOURce:]PULSe:VOLTage[:AC]#:MAXimum?
Description	This command returns the maximum permissible set value for the PULSE voltage for selected phase # or for all phases if phase reference is omitted
Returned Data Format	<nr2>
Query Example	PULS:VOLT:MAX? 440.0000
Query Syntax	[SOURce:]PULSe:VOLTage[:AC]#:DEFault?
Description	This command returns the default set value for the PULSE voltage for selected phase # or for all phases if phase reference is omitted
Returned Data Format	<nr2>
Query Example	PULS:VOLT:DEF? 0.000,0.000,0.000 PULS:VOLT1:DEF? 0.000

Command Syntax	[SOURce:]PULSe:VOLTage:DC# < nr2 >, <cr> [SOURce:]PULSe:VOLTage:DC#
Description	Voltage phase A, OPT: Voltage phase B, OPT: Voltage phase C, OPT This command sets the PULSE DC voltage for selected phase # or for all phases if phase reference is omitted.
Parameters	Voltage , < NORmal SATurate > Default is NORmal if optional second parameter is omitted.
Parameter Format	<nr2>, <cr>
Example	PULS:VOLT:DC1 270.00
Query Format	[SOURce:]PULSe:VOLTage:DC#?
Returned Data Format	<nr2>
Query Example	PULS:VOLT:DC1? 270.0000
Query Syntax	[SOURce:]PULSe:VOLTage:DC#:MINimum?
Description	This command returns the minimum permissible set value for the initial PULSE DC voltage for selected phase # or for all phases if phase reference is omitted
Returned Data Format	<nr2>
Query Example	PULS:VOLT:DC1:MIN? -425.0000
Query Syntax	[SOURce:]PULSe:VOLTage:DC#:MAXimum?
Description	This command returns the maximum permissible set value for the initial PULSE DC voltage for selected phase # or for all phases if phase reference is omitted
Returned Data Format	<nr2>
Query Example	PULS:VOLT:DC1:MAX? 425.0000
Query Syntax	[SOURce:]PULSe:VOLTage:DC#:DEFault?
Description	This command returns the default set value for the initial PULSE voltage for selected phase # or for all phases if phase reference is omitted
Returned Data Format	<nr2>
Query Example	PULS:VOLT:DC1:DEF? 0.000,0.000,0.000

<p>Command Syntax Description Parameters</p>	<p>[SOURCE:]PULSE:FREQUENCY < nr2 >, <cr> This command sets the PULSE frequency. Voltage , < NORMAL SATurate > Default is NORMAL if optional second parameter is omitted.</p>
<p>Parameter Format Example Query Format Returned Data Format Query Example</p>	<p><nr2>, <cr> PULS:FREQ 50.00 [SOURCE:]PULSE:FREQUENCY? <nr2> PULS:FREQ? 60.0000</p>
<p>Query Syntax Description</p>	<p>[SOURCE:]PULSE:FREQUENCY:MINimum? This command returns the minimum permissible set value for the PULSE frequency.</p>
<p>Returned Data Format Query Example</p>	<p><nr2> PULS:FREQ:MIN? 15.0000</p>
<p>Query Syntax Description</p>	<p>[SOURCE:]PULSE:FREQUENCY:MAXimum? This command returns the maximum permissible set value for the PULSE frequency.</p>
<p>Returned Data Format Query Example</p>	<p><nr2> PULS:FREQ:MIN? 1000.0000</p>
<p>Query Syntax Description</p>	<p>[SOURCE:]PULSE:FREQUENCY:DEFault? This command returns the default set value for the initial PULSE frequency.</p>
<p>Returned Data Format Query Example</p>	<p><nr2> PULS:FREQ:DEF? 60.0000</p>
<p>Command Syntax Description</p>	<p>[SOURCE:]PULSE:WAVEFORM# <nr1 > This command sets the selected waveform using the waveform number.</p>
<p>Parameters Parameter Format Example Query Format Returned Data Format Query Example</p>	<p>Waveform number <nr1>, <cr> PULS:WAVEFORM 1 [SOURCE:]PULSE:WAVEFORM#? <nr1> PULS:WAVEFORM#? 1.0000</p>

Query Syntax	[SOURCE:]PULSE:WAVEFORM#:MINimum?
Description	This command returns the minimum permissible set value for the PULSE waveform.
Returned Data Format	<nr1>
Query Example	PULS:WAVEFORM#:MIN? 1
Query Syntax	[SOURCE:]PULSE:WAVEFORM#:MAXimum?
Description	This command returns the maximum permissible set value for the PULSE waveform.
Returned Data Format	<nr1>
Query Example	PULS:WAVEFORM#:MAX? 200
Query Syntax	[SOURCE:]PULSE:WAVEFORM:DEFault?
Description	This command returns the default set value for the PULSE waveform.
Returned Data Format	<nr1>
Query Example	PULS:WAVEFORM:DEF? 1
Command Syntax	[SOURCE:]PULSE:PHASe# < nr2 >, <cr>
Description	This command sets the initial PULSE phase angle for selected phase # number. Only phase 2 (B) and 3 (C) are allowed.
Parameters	Phase No., < NORmal SATurate > Default is NORmal if optional second parameter is omitted.
Parameter Format	<nr1>, <cr>
Example	PULS:PHAS1 245.0
Query Format	[SOURCE:]PULSE:PHASe#?
Returned Data Format	<nr1>, <cr>
Query Example	PULS:PHAS1? 245.0000
Query Syntax	[SOURCE:]PULSE:PHASe#:MINimum?
Description	This command returns the minimum permissible set value of the initial PULSE phase angle for selected phase #
Returned Data Format	<nr1>
Query Example	PULS:PHAS1:MIN? 0.0000
Query Syntax	[SOURCE:]PULSE:PHASe#:MAXimum?
Description	This command returns the maximum permissible set value of the initial PULSE phase angle for selected phase #
Returned Data Format	<nr1>
Query Example	PULS:PHAS1:MAX? 360.000

Query Syntax	[SOURCE:]PULSE:PHASE#:DEF?
Description	This command returns the default set value of the initial PULSE phase angle for selected phase #
Returned Data Format	<nr1>
Query Example	PULS:PHAS2:DEF? 120.0000 PULS:PHAS3:DEF? 240.0000
Command Syntax	[SOURCE:]PULSE <cr>
Description	>>> <i>Alias for PROGRAM:TRANSient command.</i> <<<
Parameters	< RUN STOP PAUSE STEP RESTart >
Parameter Format	<cr>
Example	PULS RUN
Query Format	[SOURCE:]PULSE?
Description	Query format returns the pulse transient execution state as either RUN, STOP, PAUS, STEP or REST
Returned Data Format	<nr1> Return values represent running state as follows: 0 Stopped 1 Running 2 Paused 3 Stepping 4 Waiting for trigger
Query Example	PULS? 1
Command Syntax	[SOURCE:]PULSE:LOAD
Description	This command converts the pulse transient definition to the power source's regular transient segment format and loads it in the controller real-time memory for execution.
Parameters	None
Parameter Format	n/a
Example	STEP RUN
Query Format	[SOURCE:]PULSE:LOAD?
Description	Query format returns a 1 if the pulse transient load operation was successful, otherwise returns 0.
Returned Data Format	<nr1> Return values represent: 0 Load Failed 1 Load completed
Query Example	STEP? 1

Query Syntax	[SOURCE:]PULSE:PROGRESS?
Description	>>> <i>Alias for PROGRAM:TRANSient:PROGress command.</i> <<<
Parameters	None
Parameter Format	n/a
Description	Query returns the step transient execution state as either RUN, STOP, PAUS, STEP or REST
Returned Data Format	<cr> The response is a comma-separated value string representing: PROGRESS, CURRENT SEGMENT PROGRESS, CURRENT SEGMENT, CURRENT SEGMENT TIME, TOTAL TIME, TOTAL SEGMENTS, REPEAT TIME COUNTER
Query Example	PULS:PROG? 1, 45, 2, 1.2300, 2.0000, 4, 5
Query Syntax	[SOURCE:]PULSE:CHECK?
Description	This query command returns the result of a check on the programmed pulse parameters to determine if they are ok to run.
Parameters	None
Parameter Format	n/a
Description	Query returns result of PULSE parameters integrity check
Returned Data Format	<cr> The response is either OK or if not, a string containing the error.
Query Example	PULS:PROG? OK
Query Syntax	[SOURCE:]PULSE:ALL?
Description	This query command returns a comma-separated values string of the entire pulse parameters, settings, and limits. Each set value is preceded by a tag identifying the parameter. This same data structure is used for front panel display and by the web server. The advantage is that this commands returns all pulse related information using just one query command.
Parameters	None
Parameter Format	n/a
Description	Returns complete PULSE setup as a comma separated value string.
Returned Data Format	<cr>
Query Example	PULS:ALL? form,3,loaded,0,status,0,progress,0,current element progress,0,current element,0,current element time,0,total time,0,total elements,0,repeat times,0,count,1,count max,65535,count min,0,dcycle,50.0000,dcycle max,100.0000,dcycle max,0.0000,period,0,period max,50000,period min,0,width,0,width max,50000,width min,0,ramp,0,ramp max,0,ramp min,0,mode,0,mode max,2,mode min,0,frequency,60.000,frequency min,15.000,frequency max,1000.000,frequency min reason,1,frequency max reason,2,waveform all,1,waveform all exist,1,waveform a,1,waveform a exist,1,waveform b,1,waveform b exist,1,waveform c,1,waveform c exist,1,waveform max,200,waveform min,1,voltage ac all,0.000,voltage ac all max,440.000,voltage ac all min,0.000,voltage ac all max reason,2,voltage ac all min reason,0,voltage ac a,0.000,voltage ac a max,440.000,voltage ac a

min,0.000,voltage ac a max reason,2,voltage ac a min reason,0,voltage ac b,0.000,voltage ac b max,440.000,voltage ac b min,0.000,voltage ac b max reason,2,voltage ac b min reason,0,voltage ac c,0.000,voltage ac c max,440.000,voltage ac c min,0.000,voltage ac c max reason,2,voltage ac c min reason,0,voltage dc all,0.000,voltage dc all max,650.000,voltage dc all min,-650.000,voltage dc all max reason,0,voltage dc all min reason,0,voltage dc a,0.000,voltage dc a max,650.000,voltage dc a min,-650.000,voltage dc a max reason,0,voltage dc a min reason,0,voltage dc b,0.000,voltage dc b max,425.000,voltage dc b min,-650.000,voltage dc b max reason,0,voltage dc b min reason,0,voltage dc c,0.000,voltage dc c max,650.000,voltage dc c min,-650.000,voltage dc c max reason,0,voltage dc c min reason,0,phase b,120.000,phase c,240.000,phase max,360.000,phase min,0.000

8.7.16 Interharmonics Commands (IEC61000-4-13 Option C)

The following SCPI commands are used to generate interharmonics on the output of the power source. These commands require the IEC413 option “C” to be configured on the unit. If configured, the *IDN? model number response will have a “C” appended. You can also check the unit’s configuration using the SYSTem:FEATures? Command and look for the Interhamonics feature.

Command Syntax	[SOURCE:]INTHarmonic[:STATe]
Description	This command enables (1) or disables Inter Harmonics mode. When off, no interharmonics are generated. This command can only be sent while the OUTPUT is OFF. If the OUTPUT is ON, an error is generated and no change of state occurs. (“Unable to execute this action with output enabled”).
Parameters	< 0 OFF 1 ON >
Parameter Format	
Example	INTH:STAT ON
Query Format	[SOURCE:]INTHarmonic[:STATe]?
Description	Query format returns the interharmonic state setting.
Returned Data Format	
Query Example	INTH:STAT? 1
Command Syntax	[SOURCE:]INTHarmonic:SYNC
Description	This command synchronizes the fundamental frequency (H1) with the interharmonics.
Parameters	< 0 OFF 1 ON >
Parameter Format	
Example	INTH:SYNC ON
Query Format	[SOURCE:]INTHarmonic:SYNC?
Description	Query format returns the interharmonic sync setting.
Returned Data Format	
Query Example	INTH:SYNC? 1

<p>Command Syntax Description</p>	<p>[SOURCE:]INTHarmonic:MODE < 0 FREQUENCY 1 MULTIPLE > This command selects between two available Interharmonic frequency programming modes. FREQUENCY mode (0): In this mode, the interharmonic frequency is set by the SOURCE:]INTHarmonic:FREQUENCY <nr2> command. If the programmed fundamental frequency (FREQ <nr2>) changes, the interharmonics frequency does NOT change. MULTIPLE mode (1): In this mode, the interharmonics frequency is set as a multiple of the frequency setpoint. Changing the programmed fundamental frequency (FREQ <nr2>) changes also changes the interharmonics frequency. If the MULTIPLE value is an integer, the Interharmonic becomes a harmonic. Note that the MULTIPLE value can be used as multiplier (> 1.0) or divider (< 1.0)/</p>
<p>Parameters Parameter Format Example Query Format Description Returned Data Format Query Example</p>	<p>< 0 FREQUENCY 1 MULTIPLE> INTH:MODE FREQ [SOURCE:]INTHarmonic:MODE? Query format returns the interharmonic programming mode setting. <nr1> INTH:MODE? 0</p>
<p>Query Format Description Returned Data Format Query Example</p>	<p>[SOURCE:]INTHarmonic:MODE:CATalog? Returns the lower interharmonic voltage phase angle setting range for each phase or all phases. Minimum set value is 0.000°. <nr2> INTH:MODE:CAT? 0, Frequency, 1, Harmonic multiple</p>
<p>Command Syntax Description Parameters Parameter Format Example Query Format Description Returned Data Format Query Example</p>	<p>[SOURCE:]INTHarmonic:ROUNDtoharmic < 0 OFF 1 ON > This command when enabled ensures synchronization of the interharmonics when the interharmonics frequency is a multiple or divisor of the fundamental frequency. < 0 OFF 1 ON > INTH:ROUND 1 [SOURCE:]INTHarmonic:ROUND? Query format returns the interharmonic rounding mode setting. INTH:ROUND? 0</p>

<p>Command Syntax Description</p> <p>Parameters Parameter Format Example Query Format Description Returned Data Format Query Example</p>	<p>[SOURCE:]INTHarmonic:MULTiple < value > Sets the interharmonic frequency as a multiple of the fundamental frequency for all phases. The query format returns the active setting</p> <p>Multiple <nr2> INTH:MULT 3.33</p> <p>[SOURCE:]INTHarmonic:MULTiple? Query format returns the interharmonic frequency multiple setting. <nr2> INTH:MULT? 3.33</p>
<p>Command Syntax Description</p> <p>Parameters Parameter Format Example Query Format Description Returned Data Format Query Example</p>	<p>[SOURCE:]INTHarmonic:MULTiple:DEFault Sets the default multiple of the fundamental frequency for all phases. The factory default setting is 1.0000.</p> <p>Frequency <nr2> INTH:MULT:DEF 1.0</p> <p>[SOURCE:]INTHarmonic:MULTiple:DEFault? Query format returns the interharmonic multiple setting. <nr2> INTH:MULT:DEF? 1.0000</p>
<p>Query Format Description Returned Data Format Query Example</p>	<p>[SOURCE:]INTHarmonic:MULTiple:MAXimum? Returns the maximum value for the interharmonic multiple setting. <nr2> INTH:MULT:MAX? 100.0000</p>
<p>Query Format Description Returned Data Format Query Example</p>	<p>[SOURCE:]INTHarmonic:MULTiple:MINimum? Returns the minimum value for the interharmonic multiple setting. <nr2> INTH:MULT:MIN? 1.0000</p>

Command Syntax	[SOURCE:]INTHarmonic:FREQUENCY
Description	Sets the frequency of the interharmonic voltage component for all phases. The query format returns the active setting
Parameters	Frequency
Parameter Format	<nr2>
Example	INTH:FREQ 470
Query Format	[SOURCE:]INTHarmonic:FREQUENCY?
Description	Query format returns the interharmonic frequency setting.
Returned Data Format	<nr2>
Query Example	INTH:FREQ? 470.0000

Command Syntax	[SOURCE:]INTHarmonic:FREQUENCY:DEFAULT
Description	Sets the default frequency of the inter harmonic voltage component for all phases. The factory default setting is 180 Hz.
Parameters	Frequency
Parameter Format	<nr2>
Example	INTH:FREQ:DEF 90
Query Format	[SOURCE:]INTHarmonic:FREQUENCY:DEFAULT?
Description	Query format returns the interharmonic frequency setting.
Returned Data Format	<nr2>
Query Example	INTH:FREQ:DEF? 90.0000

Query Format	[SOURCE:]INTHarmonic:FREQUENCY:MAXIMUM?
Description	Returns the maximum value for the interharmonic frequency setting which is 10,000 Hz..
Returned Data Format	<nr2>
Query Example	INTH:FREQ:MAX? 10000.0000

Query Format	[SOURCE:]INTHarmonic:FREQUENCY:MINIMUM?
Description	Returns the minimum value for the interharmonic frequency setting which is 15 Hz.
Returned Data Format	<nr2>
Query Example	INTH:FREQ:MIN? 15.0000

Note: The Voltage commands are valid for the Voltage Source operating Mode only.

<p>Command Syntax Description</p>	<p>[SOURCE:]INTHarmonic:VOLTage[:AC#] Sets the inter harmonic voltage amplitude for the selected phase (1 = A, 2 = B, 3 = C) or for all three phases if the phase selection is omitted in Vac RMS</p>
<p>Parameters Parameter Format Example Query Format Description Returned Data Format Query Example</p>	<p>Voltage <nr2> INTH:VOLT:AC1 12.00 [SOURCE:]INTHarmonic:VOLTage[:AC#]? Query format returns the interharmonic amplitude setting. <nr2> INTH:VOLT? 12.0000, 0.0000, 0.0000</p>
<p>Command Syntax Description</p>	<p>[SOURCE:]INTHarmonic:VOLTage:AC#:DEFault Sets the default amplitude of the interharmonic voltage component for all phases. The factory default setting is 0.000 Vrms.</p>
<p>Parameters Parameter Format Example Query Format Description Returned Data Format Query Example</p>	<p>Frequency <nr2> INTH:VOLT:AC:DEF 5 [SOURCE:]INTHarmonic:VOLTage:AC#:DEFault? Query format returns the interharmonic default amplitude setting. <nr2> INTH:VOLT:AC:DEF? 5.0000, 5.0000, 5.0000</p>
<p>Query Format Description</p>	<p>[SOURCE:]INTHarmonic:VOLTage:AC#:MAXimum? Returns the maximum value for the interharmonic amplitude setting which is 440.0000 Vac RMS.</p>
<p>Returned Data Format Query Example</p>	<p><nr2> INTH:VOLT:AC:MAX? 440.0000</p>
<p>Query Format Description</p>	<p>[SOURCE:]INTHarmonic:VOLTage:AC#:MINimum? Returns the minimum value for the interharmonic amplitude setting which is 0.0000 Vac RMS.</p>
<p>Returned Data Format Query Example</p>	<p><nr2> INTH:VOLT:AC:MIN? 0.0000</p>

Note: The Current commands are valid for the Current Source or Active Load operating Mode only.

Command Syntax	[SOURCE:]INTHarmonic:CURRENT[:AC#]
Description	Sets the inter harmonic current amplitude for the selected phase (1 = A, 2 = B, 3 = C) or for all three phases if the phase selection is omitted in Vac RMS
Parameters	Voltage
Parameter Format	<nr2>
Example	INTH:CURR:AC1 12.00
Query Format	[SOURCE:]INTHarmonic:CURRENT[:AC#]?
Description	Query format returns the interharmonic amplitude setting.
Returned Data Format	<nr2>
Query Example	INTH:CURR? 12.0000, 0.0000, 0.0000
Command Syntax	[SOURCE:]INTHarmonic:CURRENT:AC#:DEFAULT
Description	Sets the default amplitude of the interharmonic current component for all phases. The factory default setting is 0.000 Arms.
Parameters	Frequency
Parameter Format	<nr2>
Example	INTH:CURR:AC:DEF 5
Query Format	[SOURCE:]INTHarmonic:CURRENT:AC#:DEFAULT?
Description	Query format returns the interharmonic default amplitude setting.
Returned Data Format	<nr2>
Query Example	INTH:CURR:AC:DEF? 5.0000, 5.0000, 5.0000
Query Format	[SOURCE:]INTHarmonic:CURRENT:AC#:MAXimum?
Description	Returns the maximum value for the interharmonic amplitude setting which is a function of the model in Arms.
Returned Data Format	<nr2>
Query Example	INTH:CURR:AC:MAX? 440.0000
Query Format	[SOURCE:]INTHarmonic:CURRENT:AC#:MINimum?
Description	Returns the minimum value for the interharmonic amplitude setting which is 0.0000 Arms.
Returned Data Format	<nr2>
Query Example	INTH:CURR:AC:MIN? 0.0000

<p>Command Syntax Description</p>	<p>[SOURCE:]INTHarmonic:PHASe# This command sets the interharmonic voltage phase angle with respect to the phase A interharmonic fundamental for the selected phase (2 = B, 3 = C) or for both phases if the phase selection is omitted in degrees.</p>
<p>Parameters Parameter Format Example</p>	<p>Phase <nr2> INTH:PHAS2 45.00</p>
<p>Query Format Description</p>	<p>[SOURCE:]INTHarmonic:PHASe? Query format returns the interharmonic voltage phase angle with respect to the phase A setting.</p>
<p>Returned Data Format Query Example</p>	<p><nr2> INTH:PHAS2? 45.0000</p>
<p>Command Syntax Description</p>	<p>[SOURCE:]INTHarmonic:PHASe#:DEFault The default interharmonic voltage phase angle for each phase or all phases can be selected using the following command: Factory default is 0.000° for phase A, 120.000° for phase B and 240.000° for phase C.</p>
<p>Parameters Parameter Format Example</p>	<p>Frequency <nr2> INTH:PHAS2:DEF 90</p>
<p>Query Format Description</p>	<p>[SOURCE:]INTHarmonic:PHASe#:DEFault? Query format returns the interharmonic default voltage phase angle setting.</p>
<p>Returned Data Format Query Example</p>	<p><nr2> INTH:PHAS:DEF? 0.0000, 90.0000, 240.0000</p>
<p>Query Format Description</p>	<p>[SOURCE:]INTHarmonic:PHASe#:MAXimum? Returns the upper interharmonic voltage phase angle setting range for each phase or all phases. The Maximum set values in 360.000°.</p>
<p>Returned Data Format Query Example</p>	<p><nr2> INTH:PHAS:MAX? 360.0000</p>
<p>Query Format Description</p>	<p>[SOURCE:]INTHarmonic:PHASe#:MINimum? Returns the lower interharmonic voltage phase angle setting range for each phase or all phases. Minimum set value is 0.000°.</p>
<p>Returned Data Format Query Example</p>	<p><nr2> INTH:PHAS:MIN? 0.0000</p>

8.7.17 Harmonics Generation Commands

The harmonics generation function allows up to five harmonic voltage or current components to be added to the output. The five harmonic amplitudes are regulated using five individual feedback loop, one for each harmonic frequency set. This ensures correct harmonic amplitudes regardless of load conditions.

- In Voltage Source mode, voltage harmonics are generated.
- In Current Source mode or Active Load CC mode, current harmonics are generated.

The frequency for each of the five set points can be set by the user.

Command Syntax	[SOURce:]HARmonic:VOLTage[:AC]# < comma separated values >
Description	This command sets the harmonic voltage levels for the selected phase or for all phases if the phase selection is omitted.
Parameters	Harmonic amplitude values. Up to 5 values.
Parameter Format	< nr2, nr2, nr2, nr2, nr2 >
Example	SOUR:HAR:VOLT1 10.0, 8.0, 5.0, 4.0, 3.0
Query Format	[SOURce:]HARmonic:VOLTage[:AC]#?
Description	Query format returns the harmonic voltage amplitude values
Returned Data Format	<nr2>
Query Example	SOUR:HAR:VOLT1 10.000, 8.000, 5.000, 4.000, 3.000
Query Format	[SOURce:]HARmonic:VOLTage[:AC]#:MAXimum?
Description	Returns the maximum harmonic voltage setting range for each phase or all phases. The maximum setting is determined by the model.
Returned Data Format	<nr2>
Query Example	HAR:VOLT:MAX? 440.0000

Query Format	[SOURce:]HARmonic:VOLTage[:AC]#:MINimum?
Description	Returns the Minimum harmonic voltage setting range for each phase or all phases. The minimum setting is determined by the model.
Returned Data Format	<nr2>
Query Example	HAR:VOLT:MIN? 0.0000

Note: These commands are valid for Current Source Mode and Active Load mode CC mode.

Command Syntax	[SOURce:]HARmonic:CURREnt[:AC]# < comma separated values >
Description	This command sets the harmonic current levels for the selected phase or for all phases if the phase selection is omitted.
Parameters	Harmonic amplitude values. Up to 5 values.
Parameter Format	< nr2, nr2, nr2, nr2, nr2 >
Example	SOUR:HAR:CURR1 10.0, 8.0, 5.0, 4.0, 3.0
Query Format	[SOURce:]HARmonic:CURREnt[:AC]#?
Description	Query format returns the harmonic current amplitude values
Returned Data Format	<nr2>
Query Example	SOUR:HAR:CURR1 45.0000

Query Format	[SOURce:]HARmonic:CURREnt[:AC]#:MAXimum?
Description	Returns the maximum harmonic current setting range for each phase or all phases. The maximum setting is determined by the model.
Returned Data Format	<nr2>
Query Example	HAR:CURR:MAX? 130.0000

Query Format	[SOURce:]HARmonic:CURREnt[:AC]#:MINimum?
Description	Returns the Minimum harmonic current setting range for each phase or all phases. The minimum setting is determined by the model.
Returned Data Format	<nr2>
Query Example	HAR:CURR:MIN? 0.0000

Note: These commands are valid for all Operating modes.

<p>Command Syntax Description</p>	<p>[SOURCE:]HARmonic:PERcentage# < comma separated values > This command sets the harmonic levels in percent of fundamental for the selected phase or for all phases if the phase selection is omitted.</p>
<p>Parameters Parameter Format Example</p>	<p>Harmonic amplitude values. Up to 5 values. < nr2, nr2, nr2, nr2, nr2 > SOUR:HAR:PER 20.0, 15.0, 10.0, 5,0, 2.0</p>
<p>Query Format Description Returned Data Format Query Example</p>	<p>[SOURCE:]HARmonic:PERcentage#? Query format returns the harmonic percentage values <nr2> SOUR:HAR:PER? 20.0000, 15.0000, 10.0000, 5,0000, 2.0000</p>
<p>Query Format Description</p>	<p>[SOURCE:]HARmonic:PERcentage#:MAXimum? Returns the maximum harmonic levels in percent of fundamental setting range for each phase or all phases.</p>
<p>Returned Data Format Query Example</p>	<p><nr2> HAR:PER:MAX? 100.0000</p>
<p>Query Format Description</p>	<p>[SOURCE:]HARmonic:PERcentage#:MINimum? Returns the Minimum harmonic levels in percent of fundamental setting range for each phase or all phases.</p>
<p>Returned Data Format Query Example</p>	<p><nr2> HAR:PER:MIN? 0.0000</p>
<p>Command Syntax Description</p>	<p>[SOURCE:]HARmonic:PHASE# < comma separated values > This command sets the harmonic phase angles with respect to the fundamental for the selected phase or for all phases if the phase selection is omitted.</p>
<p>Parameters Parameter Format Example</p>	<p>Harmonic amplitude values. Up to 5 values. < nr2, nr2, nr2, nr2, nr2 > SOUR:HAR:PHAS 20.0, 15.0, 10.0, 5,0, 2.0</p>
<p>Query Format Description Returned Data Format Query Example</p>	<p>[SOURCE:]HARmonic:PHASE#? Query format returns the harmonic percentage values <nr2> SOUR:HAR:PER? 20.0000, 15.0000, 10.0000, 5,0000, 2.0000</p>
<p>Query Format Description</p>	<p>[SOURCE:]HARmonic:PHASE#:MAXimum? Returns the maximum harmonic phase angles with respect to the fundamental setting range for each phase or all phases.</p>
<p>Returned Data Format Query Example</p>	<p><nr2> HAR:PHAS:MAX? 360.0000</p>

<p>Query Format Description</p>	<p>[SOURCE:]HARmonic:PHASE#:MINimum? Returns the minimum harmonic phase angles with respect to the fundamental setting range for each phase or all phases.</p>
<p>Returned Data Format Query Example</p>	<p><nr2> HAR:PHAS:MIN? 0.0000</p>
<p>Command Syntax Description</p>	<p>[SOURCE:]HARmonic:NUMBER# < comma separated values > This command sets the harmonic numbers as a multiple of the fundamental frequency for the selected phase or for all phases if the phase selection is omitted.</p>
<p>Parameters Parameter Format Example</p>	<p>Harmonic number values. Up to 5 values. < nr1, nr1, nr1, nr1, nr1 > SOUR:HAR:NUM 3,5,7,9,11</p>
<p>Query Format Description Returned Data Format Query Example</p>	<p>[SOURCE:]HARmonic:NUMBER #? Query format returns the harmonic number values <nr2> SOUR:HAR:NUM? 3,5,7,9,11,3,5,7,9,11,3,5,7,9,11</p>
<p>Query Format Description</p>	<p>[SOURCE:]HARmonic:NUMBER #:MAXimum? Returns the maximum harmonic number with respect to the fundamental frequency setting for each phase or all phases.</p>
<p>Returned Data Format Query Example</p>	<p><nr2> HAR:PHAS:MAX? 50000</p>
<p>Query Format Description</p>	<p>[SOURCE:]HARmonic:NUMBER #:MINimum? Returns the minimum harmonic number with respect to the fundamental frequency setting range for each phase or all phases.</p>
<p>Returned Data Format Query Example</p>	<p><nr2> HAR:PHAS:MIN? 0</p>
<p>Query Format Description</p>	<p>[SOURCE:]HARmonic:FREQuency#? This query command returns the programmed harmonic frequencies for all harmonics as determined by the HARmonic:NUMBER values.</p>
<p>Returned Data Format Query Example</p>	<p><nr2> For a Number setting of “3, 5, 7, 9, 15” and programmed frequency of 50.00 Hz, the response would be: HAR:FREQ? 150, 350, 450, 650, 750</p>

Command Syntax	[SOURCE:]HARmonic:MODE# < 0 1 >
Description	This command sets the harmonic data entry mode as either Percentage (0) or Absolute AC Value for the selected phase or for all phases if the phase selection is omitted.
Parameters	< 0 Percentage 1 AC Value >
Parameter Format	< b >
Example	SOUR:HAR:MODE 0
Query Format	[SOURCE:]HARmonic:MODE#?
Description	Query format returns the harmonic data entry mode
Returned Data Format	< b >
Query Example	SOUR:HAR:MODE? 0, 0, 0
Query Syntax	[SOURCE:]HARmonic:MODE:CATalog?
Description	This command returns the available mode settings for a the Harmonics Generation function.
Returned Data Format	0, Percentage, 1, AC Value
Query Example	HAR:MODE:CAT? 0, Percentage, 1, AC Value
Query Syntax	[SOURCE:]HARmonic:TOTAL?
Description	This query command returns the total number of programmable harmonics available. As of this revision manual, the total is five.
Returned Data Format	<nr1>
Query Example	HAR:TOTAL? 5

8.8 Current Source Commands

For Active Load or Current Source mode, the following current programming commands apply:

8.8.1 Current Programming Commands

Command Syntax	[SOURce:]CURRent[:AC]# <nr2>
Description	Sets AC current for phase #. If # is omitted, sets all available phases to value specified.
Parameters	Model specific
Parameter Format	<nr2>
Example	CURR:AC1 100.00
Query Format	[SOURce:]CURRent[:AC]#?
Description	Returns current setting for specified phase. If phase is omitted, returns voltage setting for all phases.
Returned Data Format	<nr2>
Query Example	CURR:AC1? 100.0000
Command Syntax	[SOURce:]CURRent[:AC]#:SLEW <nr2>
Description	This command set the programmed current slew rate for the selected phase or all phases if # is omitted.
Parameter	Current
Parameter Format	<nr2>
Example	CURR:AC:SLEW 10.0
Query Format	[SOURce:]CURRent[:AC]#:SLEW?
Returned Data Format	<nr2>
Query Example	CURR? 10.000,10.000,10.000
Query Command	[SOURce:]CURRent[:AC]:SLEW:MINimum?
Returned Data Format	<nr2>
Query Example	CURR:SLEW:MIN#? 0.010
Query Command	[SOURce:]CURRent[:AC]:SLEW:MAXimum?
Returned Data Format	<nr2>
Query Example	CURR:SLEW:MAX? 1500.000
Query Command	[SOURce:]CURRent[:AC]:SLEW:DEFault?
Returned Data Format	<nr2>
Query Example	CURR:SLEW:DEF? 10.000

Query Command	[SOURce:]CURRent[:AC]#:MINimum?
Returned Data Format	<nr2>
Query Example	CURR:MIN#? 0.0000
Query Command	[SOURce:]CURRent[:AC]#:MAXimum?
Returned Data Format	<nr2>
Query Example	CURR:MAX? 130.0000, 130.000, 130.000
Query Command	[SOURce:]CURRent[:AC]#:DEFault?
Returned Data Format	<nr2>
Query Example	CURR:DEF? 1.0000, 1.000, 1.000
Command Syntax	[SOURce:]CURRent:DC# <nr2>
Description	Sets DC current for phase #. If # is omitted, sets all available phases to value specified.
Parameters	Model specific
Parameter Format	<nr2>
Example	CURR:DC1 100.00
Query Format	[SOURce:]CURRent:DC#?
Description	Returns current setting for specified phase. If phase is omitted, returns current setting for all phases.
Returned Data Format	<nr2>
Query Example	CURR:DC1? 100.0000
Command Syntax	[SOURce:]CURRent:DC:SLEW <nr2>
Description	Sets DC current for all available phases to value specified in Amps per milisecond.
Parameters	Model specific
Parameter Format	<nr2>
Example	CURR:DC:SLEW 10.00
Query Format	[SOURce:]CURRent:DC:SLEW?
Description	Returns current setting for all available phases
Returned Data Format	<nr2>
Query Example	CURR:DC:SLEW? 10.0000
Query Command	[SOURce:]CURRent:DC:SLEW:MINimum?
Returned Data Format	<nr2>
Query Example	CURR:DC:SLEW:MIN#? 0.0000

Query Command	[SOURCE:]CURRENT:DC:SLEW:MAXimum?
Returned Data Format	<nr2>
Query Example	CURR:DC:SLEW:MAX? 100000.0000
Query Command	[SOURCE:]CURRENT:DC:SLEW:DEFault?
Returned Data Format	<nr2>
Query Example	CURR:DC:SLEW:DEF? 10.000
Query Command	[SOURCE:]CURRENT:DC#:MINimum?
Returned Data Format	<nr2>
Query Example	CURR:DC:MIN#? 0.0000
Query Command	[SOURCE:]CURRENT:DC#:MAXimum?
Returned Data Format	<nr2>
Query Example	CURR:DC:MAX? 90.0000, 90.000, 900.000
Query Command	[SOURCE:]CURRENT:DC#:DEFault?
Returned Data Format	<nr2>
Query Example	CURR:DC:DEF? 1.0000, 1.000, 1.000

8.8.2 Current Slew Rate Programming Commands

The current slew rate settings determines how fast current level changes will take place. When set to the minimum value, the Current source will slew as fast at the hardware supports.

Command Syntax	[SOURCE:]CURRENT[:AC]:SLEW <nr2>
Description	Sets AC current for all available phases to value specified in Amps per milisecond.
Parameters	Model specific
Parameter Format	<nr2>
Example	CURR:AC:SLEW 10.00
Query Format	[SOURCE:]CURRENT[:AC]:SLEW?
Description	Returns current setting for all available phases
Returned Data Format	<nr2>
Query Example	CURR:AC:SLEW? 10.0000
Query Command	[SOURCE:]CURRENT[:AC]:SLEW:MINimum?
Returned Data Format	<nr2>
Query Example	CURR:SLEW:MIN#? 0.0000
Query Command	[SOURCE:]CURRENT[:AC]:SLEW:MAXimum?
Returned Data Format	<nr2>
Query Example	CURR:SLEW:MAX? 100000.0000
Query Command	[SOURCE:]CURRENT[:AC]:SLEW:DEFault?
Returned Data Format	<nr2>
Query Example	CURR:SLEW:DEF? 10.000
Command Syntax	[SOURCE:]CURRENT:DC:SLEW <nr2>
Description	Sets DC current for all available phases to value specified in Amps per milisecond.
Parameters	Model specific
Parameter Format	<nr2>
Example	CURR:DC:SLEW 10.00
Query Format	[SOURCE:]CURRENT:DC:SLEW?
Description	Returns current setting for all available phases
Returned Data Format	<nr2>
Query Example	CURR:DC:SLEW? 10.0000

Query Command	[SOURce:]CURRent:DC:SLEW:MINimum?
Returned Data Format	<nr2>
Query Example	CURR:DC:SLEW:MIN#? 0.0000
Query Command	[SOURce:]CURRent:DC:SLEW:MAXimum?
Returned Data Format	<nr2>
Query Example	CURR:DC:SLEW:MAX? 100000.0000
Query Command	[SOURce:]CURRent:DC:SLEW:DEFault?
Returned Data Format	<nr2>
Query Example	CURR:DC:SLEW:DEF? 10.000

8.8.3 Real Time Current Slew Rate Programming Commands

These current slew rate settings are intended for use with analog input AC or DC voltage programming when in Current Source or Active Load mode of operation. In analog programming mode, the output is the amplified input with the rise time limited by this programmable slew rate setting or by the power stage response time. (100us approx.). Do not confuse these commands with the programable current slew rates for voltage settings, see **[SOURce:]CURRent[:AC]#:SLEW** in section 8.7.5.

By default this setting is at the maximum, so the output current would be the most similar to the input plus the response of the output stage. See the picture below where this slew rate is used to limit the rise time of the output regardless of input.

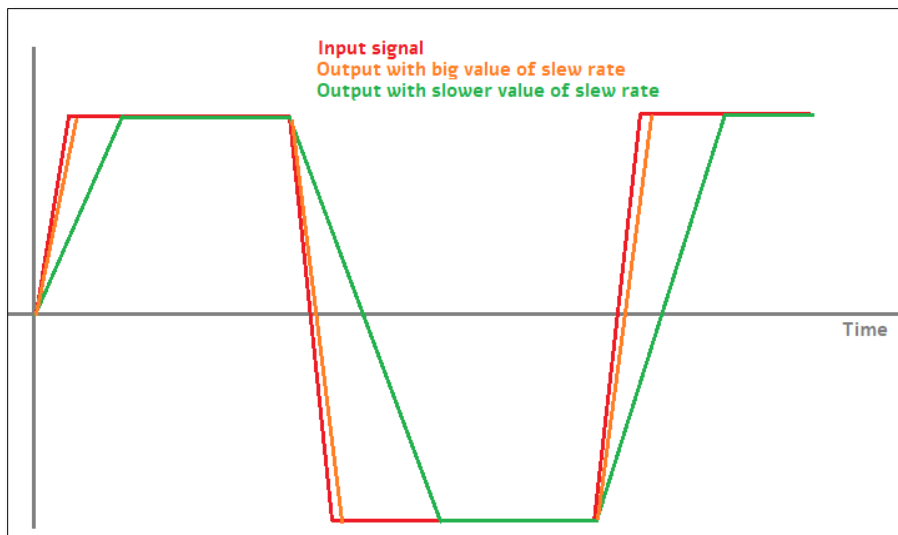

Note that for all active loads this slew is not only useful for analog programming. It is actually more useful to limit the rise time of the output current when the voltage change are externally controlled.

If the sensed input voltage suddenly changes, the unit will generate a fast change in the current to keep the setpoint. This fast change in the current may be undesirable and the way to limit it would be with this slew command. See image below.

For example, for resistance mode, the current is $I = V/R$.

The R which is the setpoint is kept constant but a sudden voltage change can cause a sudden current change. The setpoint could be in resistance, power etc, depending on the mode.

The slew rate is at the maximum by default, so it does not limit to more than the response time of the power stage.

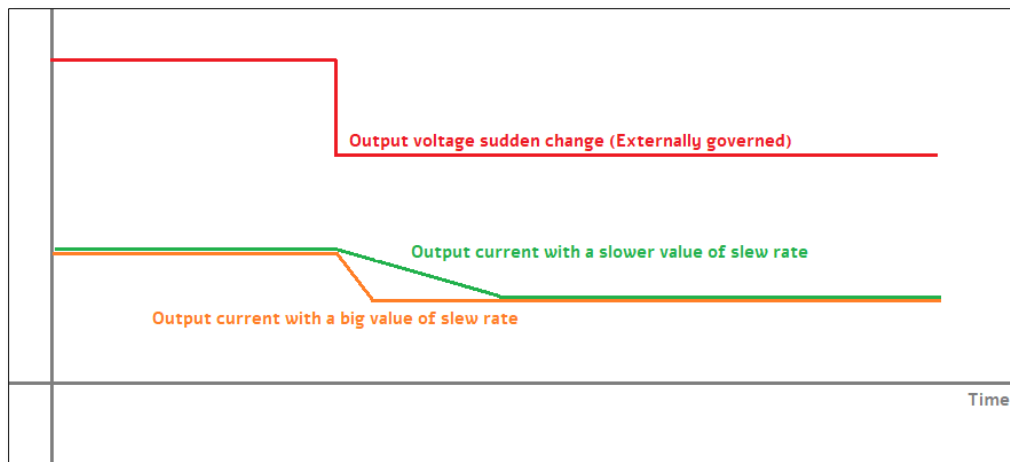

Command Syntax	[SOURCE:]SLEW:CURRENT <nr2>
Description	Sets the maximum real-time current slew rate value associated with analog programming mode.
Parameters	Current slew rate
Parameter Format	<nr2>
Example	SLEW:CURR 10.00
Query Format	[SOURCE:]SLEW:CURRENT?
Description	Returns current slew rate setting for all phases.
Returned Data Format	<nr2>
Query Example	SLEW:CURR? 10.0000
Query Syntax	[SOURCE:]SLEW:CURRENT:MINimum?
Description	Returns the minimum real-time current slew rate setting associated with analog programming mode.
Returned Data Format	<nr2>
Query Example	SLEW:CURR:MIN? 0.010

Query Syntax	[SOURCE:]SLEW:CURRENT:MAXimum?
Description	Returns the maximum real-time current slew rate setting associated with analog programming mode.
Returned Data Format	<nr2>
Query Example	SLEW:CURREN:MAX? 0.010
Query Syntax	[SOURCE:]SLEW:CURRENT:DEFAULT?
Description	Returns the default real-time current slew rate setting associated with analog programming mode.
Returned Data Format	<nr2>
Query Example	SLEW:CURREN:DEF? 0.010

8.8.4 Current Transient Programming

Transient programming while in Current Source mode is similar to the Voltage Source mode transient commands except instead of setting Voltage values, current values are set instead.

So instead of using the Voltage command

[SOURCE:]STEP:VOLTage[:AC][:INITial]# < nr2 >, <cr>

Use the equivalent Current keyword:

[SOURCE:]STEP:CURREnt[:AC][:INITial]# < nr2 >, <cr>

Refer to section 8.7.11, “STEP Transient Commands” on page 352 and section 8.7.12” PULSE Transient Commands” on page 372 for equivalent command syntax information.

8.8.5 Voltage Protection Programming Commands

Command Syntax	[SOURCE:]PROTECT:PEAK:VOLTage#[:STATE] < 0 OFF 1 ON >
Description	This command sets the maximum voltage peak margin. If the output voltage peak exceeds the programmed peak level by more than this amount, an error is tripped.
Parameters	< 0 OFF 1 ON >
Parameter Format	<cr> <nr1>
Example	PROT:PEAK:VOLT:STAT 1
Query Format	[SOURCE:]PROTECT:PEAK:VOLTage:STAT?
Returned Data Format	<nr1>
Query Example	PROT:PEAK:VOLT:STAT? 1

Command Syntax	[SOURCE:]PROTECT:PEAK:VOLTage#:MODE < 0 MARGin 1 LEVEL 2 BOTH >
Description	This command sets the maximum voltage peak margin. If the output voltage peak exceeds the programmed peak level by more than this amount, an error is tripped.
Parameters	<MARGin 0 LEVEL 1 BOTH 2 > Encoding: MARGin 0 Relative level LEVel 1 Absolute level BOTH 2 Margin and level
Parameter Format	<cr> <nr1>
Example	PROT:PEAK:VOLT:MODE BOTH
Query Format	[SOURCE:]PROTECT:PEAK:VOLTage#:MODE?
Returned Data Format	<nr1>
Query Example	PROT:PEAK:VOLT1:MODE? 2
Command Query Syntax	[SOURCE:]PROTECT:PEAK:VOLTage#:MODE:CATalog?
Description	This command returns the available parameter options for the PROT:PEAK:VOLT#:MODE command.
Example	PROT:PEAK:VOLT:MODE BOTH
Returned Data Format	0, Margin, 1, Level, 2, Margin and level
Command Syntax	[SOURCE:]PROTECT:PEAK:VOLTage#:MARGin <nr2>
Description	This command sets the maximum voltage peak margin. If the output voltage peak exceeds the programmed peak margin by more than this amount, an error is tripped.
Parameter Format	<nr2>
Example	PROT:PEAK:VOLT:MARG 120.0
Query Format	[SOURCE:]PROTECT:PEAK:VOLTage#:MARGin?
Returned Data Format	<nr2>
Query Example	PROT:PEAK:VOLT2:MARG? 120.000
Query Syntax	[SOURCE:]PROTECT:PEAK:VOLTage#:MARGin:MINimum?
Description	This command returns the minimum voltage peak margin setting.
Query Example	PROT:PEAK:VOLT1:MARG:MIN? 0.000
Query Syntax	[SOURCE:]PROTECT:PEAK:VOLTage#:MARGin:MAXimum?
Description	This command returns the maximum voltage peak margin setting
Query Example	PROT:PEAK:VOLT:MARG:MAX? 500.000

<p>Query Syntax Description Query Example</p>	<p>[SOURCE:]PROTECT:PEAK:VOLTage#:MARGin:DEFault? This command returns the default voltage peak margin setting PROT:PEAK:VOLT:MARG:DEF? 100.000</p>
<p>Command Syntax Description</p>	<p>[SOURCE:]PROTECT:PEAK:VOLTage#:LEVel <VOLTAGE LEVEL> This command sets the maximum voltage peak level. If the output voltage peak exceeds the programmed peak level by more than this amount, an error is tripped.</p>
<p>Parameters Parameter Format Example Query Format Returned Data Format Query Example</p>	<p><VOLTAGE LEVEL> <nr2> PROT:PEAK:VOLT:LEV 120.0 [SOURCE:]PROTECT:PEAK:VOLTage#:LEVel? <nr2> PROT:PEAK:VOLT:LEV? 500.000</p>
<p>Query Syntax Description Query Example</p>	<p>[SOURCE:]PROTECT:PEAK:VOLTage#:LEVel:MINimum? This command returns the minimum voltage peak level setting. PROT:PEAK:VOLT3:LEV:MIN? 0.000</p>
<p>Query Syntax Description Query Example</p>	<p>[SOURCE:]PROTECT:PEAK:VOLTage#:LEVel:MAXimum? This command returns the maximum voltage peak level setting PROT:PEAK:VOLT:LEV2:MAX? 500.000</p>
<p>Query Syntax Description Query Example</p>	<p>[SOURCE:]PROTECT:PEAK:VOLTage#:LEVel:DEFault? This command returns the default voltage peak level setting PROT:PEAK:VOLT:LEV1:DEF? 500.000</p>
<p>Query Syntax Description Query Example</p>	<p>[SOURCE:]PROTECT:PEAK:VOLTage#:TRIPped? This command returns 1 if the voltage peak protection has been tripped or 0 if no trip occurred. PROT:PEAK:VOLT:TRIP? 1</p>
<p>Command Syntax Description Parameters Parameter Format Example</p>	<p>[SOURCE:]PROTECT:PEAK:VOLTage#:TRIPped:CLEar This command clears the peak voltage protection trip status. Once cleared, the power source output can be re-enabled. <VOLTAGE LEVEL> <nr2> PROT:PEAK:VOLT3:TRIP:CLE</p>

8.8.6 Peak Current Protection Programming Commands

Command Syntax	[SOURCE:]PROTECT:PEAK:CURRENT#[[:STATE]] <0 OFF 1 ON >
Description	This command enables or disables the peak current protection. If the protection is tripped the power source output is disabled.
Parameters	< 0 OFF 1 ON >
Parameter Format	<nr1> <cr>
Example	PROTECT:CURRENT ON
Query Format	[SOURCE:]PROTECT:PEAK:CURRENT#[[:STATE]]?
Returned Data Format	<nr1>
Query Example	PROT:PEAK:CURR1? 1
Command Syntax	[SOURCE:]PROTECT:PEAK:CURRENT#:MODE < 0 MARGIN 1 LEVEL 2 BOTH >
Description	This command sets the maximum voltage peak margin. If the output voltage peak exceeds the programmed peak level by more than this amount, an error is tripped.
Parameters	<MARGIN 0 LEVEL 1 BOTH 2 > Encoding: MARGIN 0 Relative level LEVEL 1 Absolute level BOTH 2 Margin and Level
Parameter Format	<cr> <nr1>
Example	PROT:PEAK:CURR:MODE BOTH
Query Format	[SOURCE:]PROTECT:PEAK:CURRENT#:MODE?
Returned Data Format	<nr1>
Query Example	PROT:PEAK:CURR1:MODE? 2
Command Query Syntax	[SOURCE:]PROTECT:PEAK:CURRENT#:MODE:CATALOG?
Description	This command returns the available parameters options for the PROT:PEAK:CURR#:MODE command.
Example	PROT:PEAK:CURR:MODE BOTH
Returned Data Format	0, Margin, 1, Level, 2, Margin and level
Command Syntax	[SOURCE:]PROTECT:PEAK:CURRENT#:MARGIN <nr2>
Description	This command sets the peak current protection margin.
Parameters	< DELAY >
Parameter Format	<nr1>
Example	PROT:PEAK:CURR:MARG 20
Query Format	[SOURCE:]PROTECT:PEAK:CURRENT#:MARGIN?
Returned Data Format	<nr1>
Query Example	PROT:PEAK:CURR:MARG? 20

Query Syntax	[SOURCE:]PROTECT:PEAK:CURRENT#:MARGIN:MINIMUM?
Description	This command returns the peak current protection margin setting.
Query Example	PROT:PEAK:CURR:MARGIN:MIN? 0
Query Syntax	[SOURCE:]PROTECT:PEAK:CURRENT#:MARGIN:MAXIMUM?
Description	This command returns the peak current protection margin setting.
Query Example	PROT:PEAK:CURR:MARG:MAX? 3000
Query Syntax	[SOURCE:]PROTECT:PEAK:CURRENT#:MARGIN:DEFAULT?
Description	This command returns the default peak current protection margin setting.
Query Example	PROT:PEAK:CURR2:MARG:DEF? 10
Command Syntax	[SOURCE:]PROTECT:PEAK:CURRENT#:LEVEL <nr2>
Description	This command sets the peak current protection level.
Parameters	< LEVEL >
Parameter Format	<nr2>
Example	PROT:CURR:LEVEL 40.0
Query Format	[SOURCE:]PROTECT:PEAK:CURRENT#:LEVEL?
Returned Data Format	<nr2>
Query Example	PROT:PEAK:CURR:LEV? 40.000
Query Syntax	[SOURCE:]PROTECT:PEAK:CURRENT#:LEVEL:MINIMUM?
Description	This command returns the minimum peak current protection level setting.
Query Example	PROT:PEAK:CURR:LEV:MIN? 0.000
Query Syntax	[SOURCE:]PROTECT:PEAK:CURRENT#:LEVEL:MAXIMUM?
Description	This command returns the maximum peak current protection level setting.
Query Example	PROT:PEAK:CURR:LEV:MAX? 40.000
Query Syntax	[SOURCE:]PROTECT:PEAK:CURRENT#:LEVEL:DEFAULT?
Description	This command returns the default peak current protection level setting. This value will be a function of the power source model.
Query Example	PROT:PEAK:CURR:LEV:DEF? 10.000

Query Syntax	[SOURce:]PROTeCt:PEAK:CURRent#:TRIPped?
Description	This command returns peak current protection trip status. Returns 1 if tripped or 0 if not.
Query Example	PROT:PEAK:CURR:TRIP? 1
Command Syntax	[SOURce:]PROTeCt:PEAK:CURRent#:TRIPped:CLEAr
Description	This command clears the rms current protection trip status. Once cleared, the power source peak can be enabled.
Parameters	None
Parameter Format	n/a
Example	PROT:PEAK:CURR:TRIP:CLE

8.8.7 Peak Power Protection Programming Commands

Command Syntax	[SOURce:]PROTeCt:PEAK:POWEr#[:STATe] <0 OFF 1 ON >
Description	This command enables or disables the peak power protection. If the protection is tripped the power source output is disabled.
Parameters	< 0 OFF 1 ON >
Parameter Format	<nr1> <cr>
Example	PROTeCt:CURRent ON
Query Format	[SOURce:]PROTeCt:PEAK:POWEr#[:STATe]?
Returned Data Format	<nr1>
Query Example	PROT:PEAK:POW? 1

Command Syntax	[SOURce:]PROTeCt:PEAK:POWEr#:LEVEl <nr2>
Description	This command sets the peak power protection level. (in KW)
Parameters	< LEVEL >
Parameter Format	<nr2>
Example	PROT:POW:LEVEl 4.4
Query Format	[SOURce:]PROTeCt:PEAK:POWEr#:LEVEl?
Returned Data Format	<nr2>
Query Example	PROT:POW:POW:LEV? 4.4000

Query Syntax	[SOURce:]PROTeCt:PEAK:POWEr#:LEVEl:MINimum?
Description	This command returns the minimum peak power protection level setting.
Query Example	PROT:PEAK:POW:LEV:MIN? 0.000

Query Syntax	[SOURCE:]PROTECT:PEAK:POWER#:LEVEL:MAXIMUM?
Description	This command returns the maximum peak power protection level setting.
Query Example	PROT:PEAK:POW:LEV:MAX? 40.000
Query Syntax	[SOURCE:]PROTECT:PEAK:POWER#:LEVEL:DEFAULT?
Description	This command returns the default peak power protection level setting. This value will be a function of the power source model.
Query Example	PROT:PEAK:POW:LEV:DEF? 10.000
Query Syntax	[SOURCE:]PROTECT:PEAK:POWER#:TRIPPED?
Description	This command returns peak power protection trip status. Returns 1 if tripped or 0 if not.
Query Example	PROT:PEAK:POW:TRIP? 1
Command Syntax	[SOURCE:]PROTECT:PEAK:POWER#:TRIPPED:CLEAR
Description	This command clears the rms power protection trip status. Once cleared, the power source peak can be enabled.
Parameters	None
Parameter Format	n/a
Example	PROT:PEAK:POW:TRIP:CLE

8.8.8 User Limit Commands

User limit commands allow programable ranges to be limited to a narrower range than full spec in order to avoid accidental damage to an EUT. In Current Source Mode, the following Current setting user limits commands apply in lieu of the Voltage setting limit commands that apply to Voltage Source Mode. All other User Limit commands in Section 8.7, “Voltage Source Commands” on page 298 apply to all modes and are not repeated here.

Note: Do not confuse these commands with the **[SOURCE:]CURRENT:LIMIT#** commands used to set the RMS Current limit user limits applicable to the Voltage Source mode of operation as listed in section 8.7.4, “Current Programming Commands” on page 321.

Command Syntax Description	[SOURCE:]CURRENT[:AC]:USER:LIMIT:MINimum Sets low user limit for AC voltage programming. User limits must fall within actual hardware limits of the power source. Also, MIN limit must be less than MAX limit.
Parameters	0.000 – 130.000
Parameter Format	<nr2>
Example	CURR:USER:LIM:MIN 20.0
Query Format	[SOURCE:]CURRENT[:AC]:USER:LIMIT:MINimum?
Returned Data Format	<nr2>
Query Example	CURR:USER:LIM:MIN? 20.0000

Command Syntax Description	[SOURCE:]CURRENT[:AC]:USER:LIMIT:MAXimum Sets high user limit for AC current programming. User limits must fall within actual hardware limits of the power source. Also, MAX limit must be greater than MIN limit.
Parameters	0.000 – 130.000
Parameter Format	<nr2>
Example	CURR:USER:LIM:MAX 50.0
Query Format	[SOURCE:]CURRENT[:AC]:USER:LIMIT:MAXimum?
Returned Data Format	<nr2>
Query Example	CURR:USER:LIM:MAX? 50.0000

Command Syntax Description	[SOURCE:]CURRENT:DC:USER:LIMIT:MINimum Sets low user limit for DC voltage programming. User limits must fall within actual hardware limits of the power source. Also, MIN limit must be less than MAX limit.
Parameters	0.000 – 75.000
Parameter Format	<nr2>
Example	CURR:DC:USER:LIM:MIN 20.0
Query Format	[SOURCE:]CURRENT:DC:USER:LIMIT:MINimum?
Returned Data Format	<nr2>
Query Example	CURR:DC:USER:LIM:MIN? 20.0000

Command Syntax Description	[SOURCE:]CURRENT:DC:USER:LIMIT:MAXimum Sets high user limit for DC current programming. User limits must fall within actual hardware limits of the power source. Also, MAX limit must be greater than MIN limit.
Parameters	0.000 – 75.000
Parameter Format	<nr2>
Example	CURR:DC:USER:LIM:MAX 50.0
Query Format	[SOURCE:]CURRENT:DC:USER:LIMIT:MAXimum?
Returned Data Format	<nr2>
Query Example	CURR:DC:USER:LIM:MAX? 50.0000

8.8.9 Voltage and Frequency RMS Protection Commands

These under and over Voltage and Frequency RMS protections are available in all modes but most useful in active load modes where the voltage and frequency is determined by the UUT connected. The trip times apply to these protections as well and for all RMS protection types.

8.8.9.1 Under Voltage Protection

Command Syntax	[SOURCE:]PROTECT[:RMS]:UV#[:STATE] <0 OFF 1 ON >
Description	This command enables or disables the RMS under voltage protection. If the protection is tripped the power source output is disabled.
Parameters	< 0 OFF 1 ON >
Parameter Format	<nr1> <cr>
Example	PROT:UV1 ON
Query Format	[SOURCE:]PROTECT[:RMS]:UV#[:STATE]?
Returned Data Format	<nr1>
Query Example	PROT:UV1? 1
Command Syntax	[SOURCE:]PROTECT[:RMS]:UV#:LEVel <nr2>
Description	This command sets the RMS under voltage protection level.
Parameters	< LEVEL >
Parameter Format	<nr2>
Example	PROT:UV:LEV 50.0
Query Format	[SOURCE:]PROTECT[:RMS]:UV#:LEVel?
Returned Data Format	<nr2>
Query Example	PROT:UV:LEV? 50.0000
Query Syntax	[SOURCE:]PROTECT[:RMS]:UV#:LEVel:MINimum?
Description	This command returns the minimum RMS under voltage protection level setting.
Query Example	PROT:UV:LEV:MIN? 0.000
Query Syntax	[SOURCE:]PROTECT[:RMS]:UV#:LEVel:MAXimum?
Description	This command returns the maximum RMS under voltage protection level setting.
Query Example	PROT:UV:LEV:MAX? 440.000
Query Syntax	[SOURCE:]PROTECT[:RMS]:UV#:LEVel:DEFault?
Description	This command returns the default RMS under voltage protection level setting. This value will be a function of the power source model.
Query Example	PROT:UV:LEV:DEF? 10.000

<p>Command Syntax Description Parameters Parameter Format Example Query Format Returned Data Format Query Example</p>	<p>[SOURCE:]PROTECT[:RMS]:UV#:TDELAY <nr2> This command sets the RMS under voltage protection trip delay time. < LEVEL > <nr2> PROT:UV:TDELAY 50.0 [SOURCE:]PROTECT[:RMS]:UV#:TDELAY? <nr2> PROT:UV:TDELAY? 2.0000</p>
<p>Query Syntax Description Query Example</p>	<p>[SOURCE:]PROTECT[:RMS]:UV#:TDELAY:MINimum? This command returns the minimum RMS under voltage protection trip delay time.. PROT:UV:TDELAY:MIN? 0.1000</p>
<p>Query Syntax Description Query Example</p>	<p>[SOURCE:]PROTECT[:RMS]:UV#: TDELAY:MAXimum? This command returns the maximum RMS under voltage protection trip delay time. PROT:UV:TDELAY:MAX? 10.000</p>
<p>Query Syntax Description Query Example</p>	<p>[SOURCE:]PROTECT[:RMS]:UV#: TDELAY:DEFault? This command returns the default RMS under voltage protection trip delay time. PROT:UV:TDELAY:DEF? 0.1000</p>
<p>Query Syntax Description Query Example</p>	<p>[SOURCE:]PROTECT[:RMS]:UV#:TRIPped? This command returns RMS the under voltage protection trip status. Returns 1 if tripped or 0 if not. PROT:UV:TRIP? 1</p>
<p>Command Syntax Description Parameters Parameter Format Example</p>	<p>[SOURCE:]PROTECT[:RMS]:UV#:TRIPped:CLEar This command clears the RMS under voltage protection trip status. Once cleared, the power source peak can be enabled. None n/a PROT:UV:TRIP:CLE</p>

8.8.9.2 Over Voltage Protection

Command Syntax	[SOURCE:]PROTECT[:RMS]:OV#[:STATE] <0 OFF 1 ON >
Description	This command enables or disables the RMS over voltage protection. If the protection is tripped the power source output is disabled.
Parameters	< 0 OFF 1 ON >
Parameter Format	<nr1> <cr>
Example	PROT:OV1 ON
Query Format	[SOURCE:]PROTECT[:RMS]:OV#[:STATE]?
Returned Data Format	<nr1>
Query Example	PROT:OV1? 1

Command Syntax	[SOURCE:]PROTECT[:RMS]:OV#:LEVel <nr2>
Description	This command sets the RMS over voltage protection level.
Parameters	< LEVEL >
Parameter Format	<nr2>
Example	PROT:OV:LEV 50.0
Query Format	[SOURCE:]PROTECT[:RMS]:OV#:LEVel?
Returned Data Format	<nr2>
Query Example	PROT:OV:LEV? 50.0000

Query Syntax	[SOURCE:]PROTECT[:RMS]:OV#:LEVel:MINimum?
Description	This command returns the minimum RMS over voltage protection level setting.
Query Example	PROT:OV:LEV:MIN? 0.000

Query Syntax	[SOURCE:]PROTECT[:RMS]:OV#:LEVel:MAXimum?
Description	This command returns the maximum RMS over voltage protection level setting.
Query Example	PROT:OV:LEV:MAX? 440.000

Query Syntax	[SOURCE:]PROTECT[:RMS]:OV#:LEVel:DEFault?
Description	This command returns the default RMS over voltage protection level setting. This value will be a function of the power source model.
Query Example	PROT:OV:LEV:DEF? 10.000

Command Syntax	[SOURce:]PROTect[:RMS]:OV#:TDELAY <nr2>
Description	This command sets the RMS over voltage protection trip delay time.
Parameters	< LEVEL >
Parameter Format	<nr2>
Example	PROT:OV:TDELAY 50.0
Query Format	[SOURce:]PROTect[:RMS]:OV#:TDELAY?
Returned Data Format	<nr2>
Query Example	PROT:OV:TDELAY? 2.0000
Query Syntax	[SOURce:]PROTect[:RMS]:OV#:TDELAY:MINimum?
Description	This command returns the minimum RMS over voltage protection trip delay time..
Query Example	PROT:OV:TDELAY:MIN? 0.1000
Query Syntax	[SOURce:]PROTect[:RMS]:OV#: TDELAY:MAXimum?
Description	This command returns the maximum RMS over voltage protection trip delay time.
Query Example	PROT:OV:TDELAY:MAX? 10.000
Query Syntax	[SOURce:]PROTect[:RMS]:OV#: TDELAY:DEFault?
Description	This command returns the default RMS over voltage protection trip delay time.
Query Example	PROT:OV:TDELAY:DEF? 0.1000
Query Syntax	[SOURce:]PROTect[:RMS]:OV#:TRIPped?
Description	This command returns the RMS over voltage protection trip status. Returns 1 if tripped or 0 if not.
Query Example	PROT:OV:TRIP? 1
Command Syntax	[SOURce:]PROTect[:RMS]:OV#:TRIPped:CLEar
Description	This command clears the RMS over voltage protection trip status. Once cleared, the power source peak can be enabled.
Parameters	None
Parameter Format	n/a
Example	PROT:OV:TRIP:CLE

8.8.9.3 Under Frequency Protection

Command Syntax	[SOURCE:]PROTECT[:RMS]:UF#[:STATE] <0 OFF 1 ON >
Description	This command enables or disables the RMS under frequency protection. If the protection is tripped the power source output is disabled.
Parameters	< 0 OFF 1 ON >
Parameter Format	<nr1> <cr>
Example	PROT:UF ON
Query Format	[SOURCE:]PROTECT[:RMS]:UF #[:STATE]?
Returned Data Format	<nr1>
Query Example	PROT:UF? 1
Command Syntax	[SOURCE:]PROTECT[:RMS]:UF#:LEVel <nr2>
Description	This command sets the RMS under frequency protection level.
Parameters	< LEVEL >
Parameter Format	<nr2>
Example	PROT:UF:LEV 45.0
Query Format	[SOURCE:]PROTECT[:RMS]:UF#:LEVel?
Returned Data Format	<nr2>
Query Example	PROT:UF:LEV? 45.0000
Query Syntax	[SOURCE:]PROTECT[:RMS]:UF#:LEVel:MINimum?
Description	This command returns the minimum RMS under frequency protection level setting.
Query Example	PROT:UF:LEV:MIN? 0.000
Query Syntax	[SOURCE:]PROTECT[:RMS]:UF#:LEVel:MAXimum?
Description	This command returns the maximum RMS under frequency protection level setting.
Query Example	PROT:UF:LEV:MAX? 1000.0000
Query Syntax	[SOURCE:]PROTECT[:RMS]:UF#:LEVel:DEFault?
Description	This command returns the default RMS under frequency protection level setting. This value will be a function of the power source model.
Query Example	PROT:UF:LEV:DEF? 10.000

<p>Command Syntax Description</p>	<p>[SOURCE:]PROTECT[:RMS]:UF#:TDELAY <nr2> This command sets the RMS under frequency protection trip delay time.</p>
<p>Parameters</p>	< LEVEL >
<p>Parameter Format</p>	<nr2>
<p>Example</p>	PROT:UF:TDELAY 50.0
<p>Query Format</p>	[SOURCE:]PROTECT[:RMS]:UF#:TDELAY?
<p>Returned Data Format</p>	<nr2>
<p>Query Example</p>	PROT:UF:TDELAY? 2.0000
<p>Query Syntax Description</p>	<p>[SOURCE:]PROTECT[:RMS]:UF#:TDELAY:MINimum? This command returns the minimum RMS under frequency protection trip delay time..</p>
<p>Query Example</p>	PROT:UF:TDELAY:MIN? 0.1000
<p>Query Syntax Description</p>	<p>[SOURCE:]PROTECT[:RMS]:UF#: TDELAY:MAXimum? This command returns the maximum RMS under frequency protection trip delay time.</p>
<p>Query Example</p>	PROT:UF:TDELAY:MAX? 10.000
<p>Query Syntax Description</p>	<p>[SOURCE:]PROTECT[:RMS]:UF#: TDELAY:DEFault? This command returns the default RMS under frequency protection trip delay time.</p>
<p>Query Example</p>	PROT:UF:TDELAY:DEF? 0.1000
<p>Query Syntax Description</p>	<p>[SOURCE:]PROTECT[:RMS]:UF#:TRIPped? This command returns the RMS under frequency protection trip status. Returns 1 if tripped or 0 if not.</p>
<p>Query Example</p>	PROT:UF:TRIP? 1
<p>Command Syntax Description</p>	<p>[SOURCE:]PROTECT[:RMS]:UF#:TRIPped:CLEar This command clears the RMS under frequency protection trip status. Once cleared, the power source peak can be enabled.</p>
<p>Parameters</p>	None
<p>Parameter Format</p>	n/a
<p>Example</p>	PROT:UF:TRIP:CLE

8.8.9.4 Over Frequency Protection

Command Syntax	[SOURCE:]PROTECT[:RMS]:OF#[STATE] <0 OFF 1 ON >
Description	This command enables or disables the RMS over frequency protection. If the protection is tripped the power source output is disabled.
Parameters	< 0 OFF 1 ON >
Parameter Format	<nr1> <cr>
Example	PROT:OF ON
Query Format	[SOURCE:]PROTECT[:RMS]:OF #[:STATE]?
Returned Data Format	<nr1>
Query Example	PROT:OF? 1
Command Syntax	[SOURCE:]PROTECT[:RMS]:OF#:LEVEl <nr2>
Description	This command sets the RMS over frequency protection level.
Parameters	< LEVEL >
Parameter Format	<nr2>
Example	PROT:OF:LEV 45.0
Query Format	[SOURCE:]PROTECT[:RMS]:OF#:LEVEl?
Returned Data Format	<nr2>
Query Example	PROT:OF:LEV? 45.0000
Query Syntax	[SOURCE:]PROTECT[:RMS]:OF#:LEVEl:MINimum?
Description	This command returns the minimum RMS over frequency protection level setting.
Query Example	PROT:OF:LEV:MIN? 0.000
Query Syntax	[SOURCE:]PROTECT[:RMS]:OF#:LEVEl:MAXimum?
Description	This command returns the maximum RMS over frequency protection level setting.
Query Example	PROT:OF:LEV:MAX? 1000.0000
Query Syntax	[SOURCE:]PROTECT[:RMS]:OF#:LEVEl:DEFault?
Description	This command returns the default RMS over frequency protection level setting. This value will be a function of the power source model.
Query Example	PROT:OF:LEV:DEF? 10.000

Command Syntax	[SOURCE:]PROTECT[:RMS]:OF#:TDELAY <nr2>
Description	This command sets the RMS over frequency protection trip delay time.
Parameters	< LEVEL >
Parameter Format	<nr2>
Example	PROT:OF:TDELAY 50.0
Query Format	[SOURCE:]PROTECT[:RMS]:OF#:TDELAY?
Returned Data Format	<nr2>
Query Example	PROT:OF:TDELAY? 2.0000
Query Syntax	[SOURCE:]PROTECT[:RMS]:OF#:TDELAY:MINimum?
Description	This command returns the minimum RMS over frequency protection trip delay time..
Query Example	PROT:OF:TDELAY:MIN? 0.1000
Query Syntax	[SOURCE:]PROTECT[:RMS]:OF#: TDELAY:MAXimum?
Description	This command returns the maximum RMS over frequency protection trip delay time.
Query Example	PROT:OF:TDELAY:MAX? 10.000
Query Syntax	[SOURCE:]PROTECT[:RMS]:OF#: TDELAY:DEFault?
Description	This command returns the default RMS over frequency protection trip delay time.
Query Example	PROT:OF:TDELAY:DEF? 0.1000
Query Syntax	[SOURCE:]PROTECT[:RMS]:OF#:TRIPped?
Description	This command returns the RMS over frequency protection trip status. Returns 1 if tripped or 0 if not.
Query Example	PROT:OF:TRIP? 1
Command Syntax	[SOURCE:]PROTECT[:RMS]:OF#:TRIPped:CLEar
Description	This command clears the RMS over frequency protection trip status. Once cleared, the power source peak can be enabled.
Parameters	None
Parameter Format	n/a
Example	PROT:OF:TRIP:CLE

8.9 Active Load Commands

8.9.1 Load Mode Commands

The Active load commands listed in this section are only supported if the AZX is configured with the Load Option (Option H) and the Operating mode is set to Active Load. See the SYSTEM:OPMMode command for mode selection.

Available Load modes are:

- Constant Current Mode (0)
- Constant Resistance Mode (1)
- Constant Power Mode (2)
- Circuit Emulation Mode (3)

Command Syntax	LOAD:TYPE [0 1 2 3]
Description	Sets the load operating mode
Parameters	0 Constant Current 1 Constant Resistance 2 Constant Power 3 Circuit Emulation
Parameter Format	<nr1>
Example	LOAD:TYPE 0
Query Format	LOAD:TYPE?
Returned Data Format	<nr1>
Query Example	LOAD:TYPE? 2
Query Format	LOAD:TYPE:CATalog?
Description	Returns the available operating mode settings.
Returned Data Format	<csv>
Return Value	0,Constant Current,1,Constant Resistance,2,Constant Power,3,Circuit Emulation
Query Example	LOAD:TYPE:CAT? 0,Constant current,1,Constant resistance,2,Constant power,3,Circuit emulation

8.9.2 Load Sync Commands

The AZX has two sync modes when working as an AC load. A double loop PLL and a Fast Sync Mode. By default, it uses a double loop PLL that allows it to sync on all frequency ranges with a very precise phase. The PLL takes up to a few seconds to sync and detect that it is un-synced. When it detects that it is un-synced, the current is internally driven to zero.

The Fast Sync Mode is an advanced voltage comparator with hysteresis that is provided to be able to sync and un-sync fast in less than half a voltage input period. The disadvantages of this fast sync mode are:

- It is not as precise as the double loop PLL concerning the phase.
- The voltage input frequency must be close to the programmed phase frequency so they user must set the AZX to the expected voltage input frequency.

This is an example of a fast sync condition:

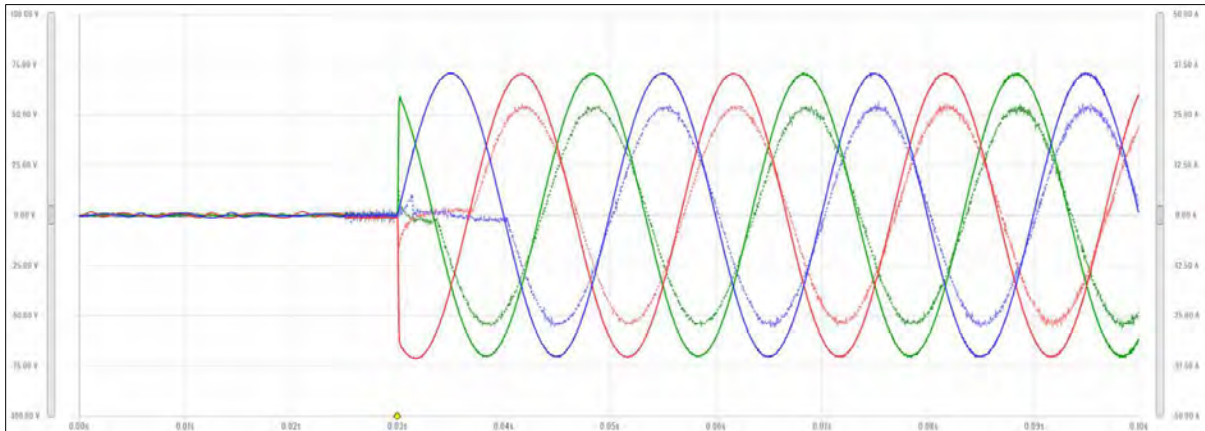

Command Syntax
Description
Parameters
Parameter Format
Example
Query Format
Returned Data Format
Query Example

LOAD:SYNC[:STATe]# <0|OFF|1|ON>
Sets the load sync mode
0 | OFF | 1 | ON
<nr1> or <cr>
LOAD:SYNC 1
LOAD:SYNC[:STATe]#?
<nr1>
LOAD:SYNC?
1

Command Syntax
Description
Parameters
Parameter Format
Example
Query Format
Returned Data Format
Query Example

LOAD:SYNC:FAST[:STATe]# <0|OFF|1|ON>
Sets the load sync mode to either PLL (0) or Fast Sync (1).
0 | OFF | 1 | ON
0 = Double Loop PLL (default), 1 = Use Fast Sync Mode
<nr1> or <cr>
LOAD:SYNC:FAST 1
LOAD:SYNC:FAST[:STATe]#?
<nr1>
LOAD:SYNC:FAST?
1

8.9.3 Load Waveform Commands

Command Syntax	LOAD:WAVEform:RECTifier[:STATe]# <0 OFF 1 ON>
Description	Enables or Disables the Load Rectifier Emulation Waveform for the selected phase # or all phases if omitted.
Parameters	0 OFF 1 ON
Parameter Format	<nr1> or <cr>
Example	LOAD:WAVE:RECT ON
Query Format	LOAD:WAVEform:RECTifier[:STATe]#?
Returned Data Format	<nr1>
Query Example	LOAD:WAVE:RECT? 1
Command Syntax	LOAD:WAVEform:RECTifier:CF# <nr2>
Description	Sets the Crest Factor of the current waveform for the selected phase # or all phases if omitted.
Parameters	Crest factor
Parameter Format	<nr2>
Example	LOAD:WAVE:RECT:CF1 3.00
Query Format	LOAD:WAVEform:RECTifier:CF#?
Returned Data Format	<nr2>
Query Example	LOAD:WAVE:RECT:CF1? 3.0000
Query Syntax	LOAD:WAVEform:RECTifier:CF#:MINimum?
Description	Returns the minimum settable Crest Factor value for the current waveform for the selected phase # or all phases if omitted.
Returned Data Format	<nr2>
Query Example	LOAD:WAVE:RECT:CF1:MIN? 1.0000
Query Syntax	LOAD:WAVEform:RECTifier:CF#:MAXimum?
Description	Returns the maximum settable Crest Factor value for the current waveform for the selected phase # or all phases if omitted.
Returned Data Format	<nr2>
Query Example	LOAD:WAVE:RECT:CF1:MAX? 10.0000

Query Syntax	LOAD:WAVEform:RECTifier:CF#:DEFault?
Description	Returns the default Crest Factor value for the current waveform for the selected phase # or all phases if omitted.
Returned Data Format	<nr2>
Query Example	LOAD:WAVE:RECT:CF1:DEF? 1.0000

8.9.4 Load SOURCE Frequency Commands

Command Syntax	[SOURCE:]FREQuency# <nr2>
Description	Sets the expected in frequency form the connected EUT AC Source for the selected phase # or all phases if omitted.
Parameters	Frequency Input
Parameter Format	<nr2>
Example	FREQ1 50.000
Query Format	[SOURCE:]FREQuency#?
Returned Data Format	<nr2>
Query Example	FREQ#? 50.0000

Query Syntax	[SOURCE:]FREQuency#:MINimum?
Description	Returns the minimum settable Frequency value for the selected phase # or all phases if omitted.
Returned Data Format	<nr2>
Query Example	FREQ:MIN1? 1.0000

Query Syntax	[SOURCE:]FREQuency#:MAXimum?
Description	Returns the maximum settable Frequency value for the selected phase # or all phases if omitted.
Returned Data Format	<nr2>
Query Example	FREQ:MAX1? 1000.0000

Query Syntax	[SOURCE:]FREQuency#:DEFault?
Description	Returns the default Frequency value for the current waveform for the selected phase # or all phases if omitted.
Returned Data Format	<nr2>
Query Example	FREQ:DEF3? 60.0000

8.9.5 Load Voltage Input Protection Commands

Command Syntax	[SOURCE:]PROTECT:PEAK:VOLTage#:LEVel <nr2>
Description	This command sets the maximum voltage peak level. If the output voltage peak exceeds the programmed peak level by more than this amount, an error is tripped.
Parameters	Voltage setting
Parameter Format	<nr2>
Example	PROT:PEAK:VOLT:LEV 120.0
Query Format	[SOURCE:]PROTECT:PEAK:VOLTage#:LEVel?
Returned Data Format	<nr2>
Query Example	PROT:PEAK:VOLT:LEV? 120.0000
Query Syntax	[SOURCE:]PROTECT:PEAK:VOLTage#:LEVel:MINimum?
Description	This command returns the minimum voltage peak level setting.
Query Example	PROT:PEAK:VOLT3:LEV:MIN? 0.0000
Query Syntax	[SOURCE:]PROTECT:PEAK:VOLTage#:LEVel:MAXimum?
Description	This command returns the maximum voltage peak level setting.
Query Example	PROT:PEAK:VOLT:LEV2:MAX? 700.0000
Query Syntax	[SOURCE:]PROTECT:PEAK:VOLTage#:LEVel:DEFault?
Description	This command returns the default voltage peak level setting
Query Example	PROT:PEAK:VOLT:LEV1:DEF? 335.0000

8.9.6 Load Phase Commands

Command Syntax	[SOURCE:]PHASe# <nr2>
Description	Sets the expected in phase angle of the connected EUT AC Source.
Parameters	Phase angle
Parameter Format	<nr2>
Example	PHAS2 120.000
Query Format	[SOURCE:]PHASe#?
Returned Data Format	<nr2>
Query Example	PHAS2? 120.0000
Query Syntax	[SOURCE:]PHASe #:MINimum?
Description	Returns the minimum settable phase angle value for the selected phase # or all phases if omitted.
Returned Data Format	<nr2>
Query Example	PHAS:MIN? -1000.000

Query Syntax	[SOURCE:]PHASe#:MAXimum?
Description	Returns the maximum settable phase angle value for the selected phase # or all phases if omitted.
Returned Data Format	<nr2>
Query Example	PHAS:MAX1? 1000.000
Query Syntax	[SOURCE:]PHASe#:DEFault?
Description	Returns the default Phase angle for the selected phase #. Defaults are 0 for Phase1, 120 for Phase2 and 240 for Phase3.
Returned Data Format	<nr2>
Query Example	PHAS:DEF2? 120.000

8.9.7 Load Power & KVA Limit Commands

Command Syntax	[SOURCE:]POWER:LIMit# <nr2>
Description	Sets the maximum allowable Real Power in kW to accept from the connected EUT AC Source on the selected phase #.
Parameters	True Power Limit
Parameter Format	<nr2>
Example	POW:LIM1 15.000
Query Format	[SOURCE:]POWER:LIMit#?
Returned Data Format	<nr2>
Query Example	POW:LIM? 15.0000
Query Syntax	[SOURCE:]POWER:LIMit#:MINimum?
Description	Returns the minimum settable Real Power in kW for the selected phase # or all phases if omitted.
Returned Data Format	<nr2>
Query Example	POW:LIM:MIN? 0.0000
Query Syntax	[SOURCE:]POWER:LIMit#:MAXimum??
Description	Returns the maximum settable Real Power in kW for the selected phase # or all phases if omitted.
Returned Data Format	<nr2>
Query Example	POW:LIM:MAX? 17.2500
Query Syntax	[SOURCE:]POWER:LIMit#:DEFault??
Description	Returns the default Real Power limit setting in kW for the selected phase # or all phases if omitted.
Returned Data Format	<nr2>
Query Example	POW:LIM:DEF? 17.2500

Command Syntax	[SOURce:]KVA:LIMit# <nr2>
Description	Sets the maximum allowable Apparent Power in kVA to accept from the connected EUT AC Source on the selected phase #.
Parameters	Apparent Power Limit
Parameter Format	<nr2>
Example	POW:LIM1 15.000
Query Format	[SOURce:]KVA:LIMit#?
Returned Data Format	<nr2>
Query Example	KVA:LIM? 15.0000
Query Syntax	[SOURce:]KVA:LIMit#:MINimum?
Description	Returns the minimum settable Apparent Power in kVA for the selected phase # or all phases if omitted.
Returned Data Format	<nr2>
Query Example	KVA:LIM1:MIN? 0.0000
Query Syntax	[SOURce:]KVA:LIMit#:MAXimum??
Description	Returns the maximum settable Apparent Power in kVA for the selected phase # or all phases if omitted.
Returned Data Format	<nr2>
Query Example	KVA:LIM:MAX1? 17.2500
Query Syntax	[SOURce:]KVA:LIMit#:DEFault??
Description	Returns the default Apparent Power limit setting in kVA for the selected phase # or all phases if omitted.
Returned Data Format	<nr2>
Query Example	KVA:LIM:DEF? 17.2500

8.9.8 Load CC Mode Commands

Command Syntax	[SOURce:]CURRENT[:AC]# <nr2>
Description	Sets the AC rms current setting for the selected phase # or all phases if omitted. A negative values represents regenerative current flow.
Parameters	Current RMS
Parameter Format	<nr2>
Example	CURR:AC1 100.000
Query Format	[SOURce:]CURRENT#?
Returned Data Format	<nr2>
Query Example	CURR1? 100.0000
Query Syntax	[SOURce:]CURRENT[:AC]#:MINimum?
Description	Returns the minimum settable AC rms current setting value for the selected phase # or all phases if omitted.
Returned Data Format	<nr2>
Query Example	CURR:MIN? -75.000,-75.000,-75.000
Query Syntax	[SOURce:]CURRENT[:AC]#:MAXimum?
Description	Returns the maximum settable AC rms current setting value for the selected phase # or all phases if omitted.
Returned Data Format	<nr2>
Query Example	CURR:MAX? 75.000,75.000,75.000
Query Syntax	[SOURce:]CURRENT[:AC]#:DEFault?
Description	Returns the default settable AC rms current setting value for the selected phase # or all phases if omitted.
Returned Data Format	<nr2>
Query Example	CURR:DEF? 0.000,0.000,0.000
Command Syntax	[SOURce:]CURRENT:DC# <nr2>
Description	Sets the DC current setting for the selected phase # or all phases if omitted.
Parameters	Current DC
Parameter Format	<nr2>
Example	CURR:DC1 75.000
Query Format	[SOURce:]CURRENT:DC#?
Returned Data Format	<nr2>
Query Example	CURR:DC1? 75.0000

Query Syntax	[SOURce:]CURRent:DC#:MINimum?
Description	Returns the minimum settable DC current setting value for the selected phase # or all phases if omitted.
Returned Data Format	<nr2>
Query Example	CURR:MIN? -50.000,-50.000,-50.000
Query Syntax	[SOURce:]CURRent:DC#:MAXimum?
Description	Returns the maximum settable DC current setting value for the selected phase # or all phases if omitted.
Returned Data Format	<nr2>
Query Example	CURR:DC:MAX? 50.000,50.000,50.000
Query Syntax	[SOURce:]CURRent:DC#:DEFault?
Description	Returns the default settable DC current setting value for the selected phase # or all phases if omitted.
Returned Data Format	<nr2>
Query Example	CURR:DC:DEF? 0.000,0.000,0.000

8.9.9 Load CR Mode Commands

In this mode the setpoint are resistance/conductance. The units generate the current based on the voltage measurement and the setpoint. There are four types for this mode:

Resistance RMS

Setpoint are resistive in Ohms, infinite option is available. The output current waveform is the arbitrary or the rectifier one. The output current is computed as:

$$I_{out} = V_{ac}/S_{ac} * \text{waveform}(t) + V_{dc}/S_{dc}$$

Where:

V_{ac} is the measured voltage AC

V_{dc} is the measured voltage DC

Waveform(t) is the normalized arbitrary or rectifier waveform.

S_{ac} is the AC setpoint

S_{dc} is the DC setpoint

Conductance RMS

Analog to resistive RMS but the setpoints are in conductance units or siemens. This mode can be useful because a zero setting generates zero load current whereas a zero in Ohms would be an infinite current. In the equation above the setpoints multiples instead of divide.

Instant Resistance

The difference with the RMS mode is that it uses the instantaneous voltage instead of the RMS.

For AC, the arbitrary waveform control the instant resistance.

Instant Conductance

Analog to instant resistance but the setpoints are in conductance units or siemens.

Other features:

- All the types have the sync control.
- As with constant current load the sync enabled is useful to sync the generation with the output voltage.
- The peak current limit limits the peak current in real time by clipping the waveform.
- The max current slew limits the slew rate of the current in real time.
- Rectifier waveform is available for the RMS modes.

Note: This Load mode of operation does **not** support the following functions:

- Interharmonics & Harmonics

<p>Query Syntax Description</p>	<p>LOAD:CR:TYPE#:CATalog? This command returns the available Constant Resistance Load type selections as a comma separated value list. 0 Resistance RMS 1 Conductance RMS 2 Instant Resistance 3 Instant Conductance</p>
<p>Returned Data Format Query Example</p>	<p><csv> LOAD:CR:TYPE:CAT? 0,Resistance RMS,1,Conductance RMS,2,Instant Resistance,3,Instant Conductance</p>
<p>Command Syntax Description</p>	<p>LOAD:CR:TYPE# <nr1> Sets the CR Load type setting for the selected phase # or all phases if omitted.</p>
<p>Parameters Parameter Format Example Query Format Returned Data Format Query Example</p>	<p>0 1 2 3 <nr1>, <cr> LOAD:CR:TYPE 2 LOAD:CR:TYPE#? <nr1> LOAD:CR:TYPE? 2</p>
<p>Query Syntax Description</p>	<p>LOAD:CR:MODE#:CATalog? This command returns the available Constant Resistance Load mode selections as a comma separated value list.</p>
<p>Returned Data Format Query Example</p>	<p><csv> LOAD:CR:MOD:CAT? 0,AC,1,DC,2,AC&DC,3,AC=DC</p>
<p>Command Syntax Description</p>	<p>LOAD:CR:MODE# <nr1> Sets the CR Load coupling mode setting for the selected phase # or all phases if omitted. Available settings are 0 for AC, 1 for DC, 2 for AC&DC or 3 for AC=DC</p>
<p>Parameters Parameter Format Example Query Format Returned Data Format Query Example</p>	<p>0 1 2 3 <nr1>, <cr> LOAD:CR:MOD 2 LOAD:CR:MODE#? <nr1> LOAD:CR:MOD? 1,3,2</p>

<p>Command Syntax Description</p>	<p>LOAD:CR:RESistance# <nr2> Sets the CR Load mode resistance setting in Ohms for the selected phase # or all phases if omitted.</p>
<p>Parameters</p>	<p>CR mode</p>
<p>Parameter Format</p>	<p><nr2></p>
<p>Example</p>	<p>LOAD:CR:RES 1.258</p>
<p>Query Format</p>	<p>LOAD:CR:RESistance#?</p>
<p>Returned Data Format</p>	<p><nr2></p>
<p>Query Example</p>	<p>LOAD:CR:RES? 1.2580</p>

<p>Query Syntax Description</p>	<p>LOAD:CR:RESistance#:MINimum? Returns the minimum settable Resistance setting value for the selected phase # or all phases if omitted.</p>
<p>Returned Data Format</p>	<p><nr2></p>
<p>Query Example</p>	<p>LOAD:CR:RES1:MIN? -100000.0000</p>

<p>Query Syntax Description</p>	<p>LOAD:CR:RESistance#:MAXimum? Returns the maximum settable Resistance setting value for the selected phase # or all phases if omitted.</p>
<p>Returned Data Format</p>	<p><nr2></p>
<p>Query Example</p>	<p>LOAD:CR:RES1:MAX? 100000.0000</p>

<p>Query Syntax Description</p>	<p>LOAD:CR:RESistance#:DEFault? Returns the default Resistance setting value for the selected phase # or all phases if omitted.</p>
<p>Returned Data Format</p>	<p><nr2></p>
<p>Query Example</p>	<p>LOAD:CR:RES1:DEF? 10.0000</p>

<p>Command Syntax Description</p>	<p>LOAD:CR:RESistance:AC# <nr2> Sets the CR Load mode AC only resistance setting in Ohms for the selected phase # or all phases if omitted.</p>
<p>Parameters</p>	<p>Setting</p>
<p>Parameter Format</p>	<p><nr2></p>
<p>Example</p>	<p>LOAD:CR:RES:AC1 2.258</p>
<p>Query Format</p>	<p>LOAD:CR:RESistance:AC#?</p>
<p>Returned Data Format</p>	<p><nr2></p>
<p>Query Example</p>	<p>LOAD:CR:RES:AC1? 2.2580</p>

<p>Query Syntax Description</p>	<p>LOAD:CR:RESistance:AC#:MINimum? Returns the minimum settable AC Resistance setting value for the selected phase # or all phases if omitted.</p>
<p>Returned Data Format Query Example</p>	<p><nr2> LOAD:CR:RES:AC1:MIN? -100000.0000</p>
<p>Query Syntax Description</p>	<p>LOAD:CR:RESistance:AC#:MAXimum? Returns the maximum settable AC Resistance setting value for the selected phase # or all phases if omitted.</p>
<p>Returned Data Format Query Example</p>	<p><nr2> LOAD:CR:RES:AC1:MAX? 100000.0000</p>
<p>Query Syntax Description</p>	<p>LOAD:CR:RESistance:AC#:DEFault? Returns the default AC Resistance setting value for the selected phase # or all phases if omitted.</p>
<p>Returned Data Format Query Example</p>	<p><nr2> LOAD:CR:RES:AC1:DEF? 10.0000</p>
<p>Command Syntax Description</p>	<p>LOAD:CR:RESistance:AC#:USER:LIMit:MINimum <nr2> Sets the lower user limit for CR Load mode AC only resistance setting in Ohms for the selected phase # or all phases if omitted.</p>
<p>Parameters Parameter Format Example Query Format Returned Data Format Query Example</p>	<p>Setting <nr2> LOAD:CR:RES:AC1:USER:LIM:MIN 0.100 LOAD:CR:RESistance:AC#:USER:LIMit:MINimum? <nr2> LOAD:CR:RES:AC1:USER:LIM:MIN? 0.1000</p>
<p>Command Syntax Description</p>	<p>LOAD:CR:RESistance:AC#:USER:LIMit:MAXimum <nr2> Sets the upper user limit for CR Load mode AC only resistance setting in Ohms for the selected phase # or all phases if omitted.</p>
<p>Parameters Parameter Format Example Query Format Returned Data Format Query Example</p>	<p>Setting <nr2> LOAD:CR:RES:AC1:USER:LIM:MAX 10000.00 LOAD:CR:RESistance:AC#:USER:LIMit:MAXimum? <nr2> LOAD:CR:RES:AC1:USER:LIM:MAX? 10000.0000</p>

<p>Query Syntax Description</p> <p>Returned Data Format Query Example</p>	<p>LOAD:CR:RESistance:AC#:USER:LIMit:RANGe? Returns the available setting range for the AC Resistance user limit setting for the selected phase # or all phases if omitted.</p> <p><nr2>, <nr2> LOAD:CR:RES:AC3:USER:LIM:RANG? 0.1000, 10000.0000</p>
<p>Query Syntax Description</p> <p>Returned Data Format Query Example</p>	<p>LOAD:CR:RESistance:AC#:RANGe:MINimum? Returns the minimum settable AC Resistance Range setting value for the selected phase # or all phases if omitted.</p> <p><nr2> LOAD:CR:RES:AC1:RANG:MIN? 0.1000</p>
<p>Query Syntax Description</p> <p>Returned Data Format Query Example</p>	<p>LOAD:CR:RESistance:AC#:RANGe:MAXimum? Returns the maximum settable AC Resistance Range setting value for the selected phase # or all phases if omitted.</p> <p><nr2> LOAD:CR:RES:AC1:RANG:MAX? 10000.0000</p>
<p>Query Syntax Description</p> <p>Returned Data Format Query Example</p>	<p>LOAD:CR:RESistance:AC#:RANGe? Returns the Min and Max AC Resistance Range setting values for the selected phase # or all phases if omitted.</p> <p><nr2>, <nr2> LOAD:CR:RES:AC#:RANG? 0.1000, 10.0000</p>
<p>Command Syntax Description</p> <p>Parameters Parameter Format Example Query Format Returned Data Format Query Example</p>	<p>LOAD:CR:RESistance:AC#:SLEW <nr2> Sets the CR Load mode AC Resistance setting slew rate in Ohms per second for the selected phase # or all phases if omitted.</p> <p>Setting <nr2> LOAD:CR:RES:AC2:SLEW 100.00</p> <p>LOAD:CR:RESistance:AC#:SLEW? <nr2> LOAD:CR:RES:AC2:SLEW? 100.0000</p>
<p>Query Syntax Description</p> <p>Returned Data Format Query Example</p>	<p>LOAD:CR:RESistance:AC#:SLEW:MINimum? Returns the minimum settable AC Resistance slew rate setting value for the selected phase # or all phases if omitted.</p> <p><nr2> LOAD:CR:RES:AC1:SLEW:MIN? 0.001</p>

<p>Query Syntax Description</p> <p>Returned Data Format Query Example</p>	<p>LOAD:CR:RESistance:AC#:SLEW:MAXimum? Returns the maximum settable AC Resistance slew rate setting value for the selected phase # or all phases if omitted.</p> <p><nr2> LOAD:CR:RES:AC1:SLEW:MAX? 1000.000</p>
<p>Query Syntax Description</p> <p>Returned Data Format Query Example</p>	<p>LOAD:CR:RESistance:AC#:SLEW:DEFault? Returns the default AC Resistance slew rate setting value for the selected phase # or all phases if omitted.</p> <p><nr2> LOAD:CR:RES:AC1:DEF? 10.000</p>
<p>Command Syntax Description</p> <p>Parameters Parameter Format Example Query Format Returned Data Format Query Example</p>	<p>LOAD:CR:RESistance:DC# <nr2> Sets the CR Load mode DC only resistance setting in Ohms for the selected phase # or all phases if omitted.</p> <p>Setting <nr2> LOAD:CR:RES:DC1 2.258</p> <p>LOAD:CR:RESistance:DC#? <nr2> LOAD:CR:RES:DC1? 2.2580</p>
<p>Query Syntax Description</p> <p>Returned Data Format Query Example</p>	<p>LOAD:CR:RESistance:DC#:MINimum? Returns the minimum settable DC Resistance setting value for the selected phase # or all phases if omitted.</p> <p><nr2> LOAD:CR:RES:DC1:MIN? -100000.0000</p>
<p>Query Syntax Description</p> <p>Returned Data Format Query Example</p>	<p>LOAD:CR:RESistance:DC#:MAXimum? Returns the maximum settable DC Resistance setting value for the selected phase # or all phases if omitted.</p> <p><nr2> LOAD:CR:RES:AC1:DC:MAX? 10000.0000</p>
<p>Query Syntax Description</p> <p>Returned Data Format Query Example</p>	<p>LOAD:CR:RESistance:DC#:DEFault? Returns the default DC Resistance setting value for the selected phase # or all phases if omitted.</p> <p><nr2> LOAD:CR:RES:DC1:DEF? 10.0000</p>

Command Syntax	LOAD:CR:RESistance:DC#:USER:LIMit:MINimum <nr2>
Description	Sets the lower user limit for CR Load mode AC only resistance setting in Ohms for the selected phase # or all phases if omitted.
Parameters	Setting
Parameter Format	<nr2>
Example	LOAD:CR:RES:DC1:USER:LIM:MIN 0.100
Query Format	LOAD:CR:RESistance:DC#:USER:LIMit:MINimum?
Returned Data Format	<nr2>
Query Example	LOAD:CR:RES:DC1:USER:LIM:MIN? 0.1000
Command Syntax	LOAD:CR:RESistance:DC#:USER:LIMit:MAXimum <nr2>
Description	Sets the upper user limit for CR Load mode DC only resistance setting in Ohms for the selected phase # or all phases if omitted.
Parameters	Setting
Parameter Format	<nr2>
Example	LOAD:CR:RES:DC1:USER:LIM:MAX 10000.00
Query Format	LOAD:CR:RESistance:DC#:USER:LIMit:MAXimum?
Returned Data Format	<nr2>
Query Example	LOAD:CR:RES:DC1:USER:LIM:MAX? 10000.0000
Query Syntax	LOAD:CR:RESistance:DC#:USER:LIMit:RANGe?
Description	Returns the available setting range for the DC Resistance user limit setting for the selected phase # or all phases if omitted.
Returned Data Format	<nr2>, <nr2>
Query Example	LOAD:CR:RES:DC3:USER:LIM:RANG? 0.1000, 10000.0000
Query Syntax	LOAD:CR:RESistance:DC#:RANGe:MINimum?
Description	Returns the minimum settable DC Resistance Range setting value for the selected phase # or all phases if omitted.
Returned Data Format	<nr2>
Query Example	LOAD:CR:RES:DC1:RANG:MIN? 0.1000
Query Syntax	LOAD:CR:RESistance:DC#:RANGe:MAXimum?
Description	Returns the maximum settable DC Resistance Range setting value for the selected phase # or all phases if omitted.
Returned Data Format	<nr2>
Query Example	LOAD:CR:RES:DC1:RANG:MAX? 10000.0000

<p>Query Syntax Description</p> <p>Returned Data Format Query Example</p>	<p>LOAD:CR:RESistance:DC#:RANGe? Returns the Min and Max DC Resistance Range setting values for the selected phase # or all phases if omitted.</p> <p><nr2>, <nr2> LOAD:CR:RES:DC#:RANG? 0.1000, 10.0000</p>
<p>Command Syntax Description</p> <p>Parameters Parameter Format Example Query Format Returned Data Format Query Example</p>	<p>LOAD:CR:RESistance:DC#:SLEW <nr2> Sets the CR Load mode DC Resistance setting slew rate in Ohms per second for the selected phase # or all phases if omitted.</p> <p>Setting <nr2> LOAD:CR:RES:DC2:SLEW 100.00 LOAD:CR:RESistance:DC#:SLEW? <nr2> LOAD:CR:RES:DC2:SLEW? 100.0000</p>
<p>Query Syntax Description</p> <p>Returned Data Format Query Example</p>	<p>LOAD:CR:RESistance:DC#:SLEW:MINimum? Returns the minimum settable DC Resistance slew rate setting value for the selected phase # or all phases if omitted.</p> <p><nr2> LOAD:CR:RES:DC1:SLEW:MIN? 0.001</p>
<p>Query Syntax Description</p> <p>Returned Data Format Query Example</p>	<p>LOAD:CR:RESistance:DC#:SLEW:MAXimum? Returns the maximum settable DC Resistance slew rate setting value for the selected phase # or all phases if omitted.</p> <p><nr2> LOAD:CR:RES:DC1:SLEW:LMAX? 1000.000</p>
<p>Query Syntax Description</p> <p>Returned Data Format Query Example</p>	<p>LOAD:CR:RESistance:DC#:SLEW:DEFault? Returns the default DC Resistance slew rate setting value for the selected phase # or all phases if omitted.</p> <p><nr2> LOAD:CR:RES:DC1:SLEW:DEF? 10.000</p>

Command Syntax	LOAD:CR:CONductance# <nr2>
Description	Sets the CR Load mode conductance setting in Siemes for the selected phase # or all phases if omitted.
Parameters	Setting
Parameter Format	<nr2>
Example	LOAD:CR:CON3 0.001
Query Format	LOAD:CR:CONductance#?
Returned Data Format	<nr2>
Query Example	LOAD:CR:CON3? 0.0001
Query Syntax	LOAD:CR:CONductance#:MINimum?
Description	Returns the minimum settable conductance setting value for the selected phase # or all phases if omitted.
Returned Data Format	<nr2>
Query Example	LOAD:CR:CON1:MIN? -0.1382
Query Syntax	LOAD:CR:CONductance#:MAXimum?
Description	Returns the maximum settable conductance setting value for the selected phase # or all phases if omitted.
Returned Data Format	<nr2>
Query Example	LOAD:CR:CON1:MAX? 0.1382
Query Syntax	LOAD:CR:CONductance#:DEFault?
Description	Returns the default conductance setting value for the selected phase # or all phases if omitted.
Returned Data Format	<nr2>
Query Example	LOAD:CR:CON1:DEF? 0.0000
Command Syntax	LOAD:CR:CONductance:AC# <nr2>
Description	Sets the CR Load mode AC only conductance setting in Siemens for the selected phase # or all phases if omitted.
Parameters	Setting
Parameter Format	<nr2>
Example	LOAD:CR:CON:AC1 2.258
Query Format	LOAD:CR:CONductance:AC#?
Returned Data Format	<nr2>
Query Example	LOAD:CR:CON:AC1? 2.2580

<p>Query Syntax Description</p> <p>Returned Data Format Query Example</p>	<p>LOAD:CR:CONductance:AC#:MINimum? Returns the minimum settable AC conductance setting value for the selected phase # or all phases if omitted.</p> <p><nr2> LOAD:CR:CON:AC1:MIN? -0.2362</p>
<p>Query Syntax Description</p> <p>Returned Data Format Query Example</p>	<p>LOAD:CR:CONductance:AC#:MAXimum? Returns the maximum settable AC conductance setting value for the selected phase # or all phases if omitted.</p> <p><nr2> LOAD:CR:CON:AC1:MAX? 0.2362</p>
<p>Query Syntax Description</p> <p>Returned Data Format Query Example</p>	<p>LOAD:CR:CONductance:AC#:DEFault? Returns the default AC conductance setting value for the selected phase # or all phases if omitted.</p> <p><nr2> LOAD:CR:CON:AC1:DEF? 0.0000</p>
<p>Command Syntax Description</p> <p>Parameters Parameter Format Example Query Format Returned Data Format Query Example</p>	<p>LOAD:CR:CONductance:AC#:USER:LIMit:MINimum <nr2> Sets the lower user limit for CR Load mode AC only conductance setting in Ohms for the selected phase # or all phases if omitted.</p> <p>Setting <nr2> LOAD:CR:CON:AC1:USER:LIM:MIN 0.100</p> <p>LOAD:CR:CONductance:AC#:USER:LIMit:MINimum? <nr2> LOAD:CR:CON:AC1:USER:LIM:MIN? 0.1000</p>
<p>Command Syntax Description</p> <p>Parameters Parameter Format Example Query Format Returned Data Format Query Example</p>	<p>LOAD:CR:CONductance:AC#:USER:LIMit:MAXimum <nr2> Sets the upper user limit for CR Load mode AC only conductance setting in Ohms for the selected phase # or all phases if omitted.</p> <p>Setting <nr2> LOAD:CR:CON:AC1:USER:LIM:MAX 10000.00</p> <p>LOAD:CR:CONductance:AC#:USER:LIMit:MAXimum? <nr2> LOAD:CR:CON:AC1:USER:LIM:MAX? 10000.0000</p>

Query Syntax	LOAD:CR:CONductance:AC#:USER:LIMit:RANGe?
Description	Returns the available setting range for the AC conductance user limit setting for the selected phase # or all phases if omitted.
Returned Data Format	<nr2>, <nr2>
Query Example	LOAD:CR:CON:AC3:USER:LIM:RANG? 0.1000, 10000.0000
Query Syntax	LOAD:CR:CONductance:AC#:RANGe:MINimum?
Description	Returns the minimum settable AC conductance Range setting value for the selected phase # or all phases if omitted.
Returned Data Format	<nr2>
Query Example	LOAD:CR:CON:AC1:RANG:MIN? 0.1000
Query Syntax	LOAD:CR:CONductance:AC#:RANGe:MAXimum?
Description	Returns the maximum settable AC conductance Range setting value for the selected phase # or all phases if omitted.
Returned Data Format	<nr2>
Query Example	LOAD:CR:CON:AC1:RANG:MAX? 10000.0000
Query Syntax	LOAD:CR:CONductance:AC#:RANGe?
Description	Returns the Min and Max AC conductance Range setting values for the selected phase # or all phases if omitted.
Returned Data Format	<nr2>, <nr2>
Query Example	LOAD:CR:CON:AC#:RANG? 0.1000, 10.0000
Command Syntax	LOAD:CR:CONductance:AC#:SLEW <nr2>
Description	Sets the CR Load mode AC conductance setting slew rate in Siemens per second for the selected phase # or all phases if omitted.
Parameters	Setting
Parameter Format	<nr2>
Example	LOAD:CR:CON:AC2:SLEW 100.00
Query Format	LOAD:CR:CONductance:AC#:SLEW?
Returned Data Format	<nr2>
Query Example	LOAD:CR:CON:AC2:SLEW? 100.0000
Query Syntax	LOAD:CR:CONductance:AC#:SLEW:MINimum?
Description	Returns the minimum settable AC conductance slew rate setting value for the selected phase # or all phases if omitted.
Returned Data Format	<nr2>
Query Example	LOAD:CR:CON:AC1:SLEW:MIN? -0.2362

Query Syntax	LOAD:CR:CONductance:AC#:SLEW:MAXimum?
Description	Returns the maximum settable AC conductance slew rate setting value for the selected phase # or all phases if omitted.
Returned Data Format	<nr2>
Query Example	LOAD:CR:CON:AC1:SLEW:MAX? 0.2362
Query Syntax	LOAD:CR:CONductance:AC#:SLEW:DEFault?
Description	Returns the default AC conductance slew rate setting value for the selected phase # or all phases if omitted.
Returned Data Format	<nr2>
Query Example	LOAD:CR:CON:AC1:SLEW:DEF? 10.000
Command Syntax	LOAD:CR:CONductance:DC# <nr2>
Description	Sets the CR Load mode DC only conductance setting in Siemens for the selected phase # or all phases if omitted.
Parameters	Setting
Parameter Format	<nr2>
Example	LOAD:CR:CON:DC1 0.200
Query Format	LOAD:CR:CONductance:DC#?
Returned Data Format	<nr2>
Query Example	LOAD:CR:CON:DC1? 0.2000
Query Syntax	LOAD:CR:CONductance:DC#:MINimum?
Description	Returns the minimum settable DC conductance setting value for the selected phase # or all phases if omitted.
Returned Data Format	<nr2>
Query Example	LOAD:CR:CON:DC1:MIN? -0.3333
Query Syntax	LOAD:CR:CONductance:DC#:MAXimum?
Description	Returns the maximum settable DC conductance setting value for the selected phase # or all phases if omitted.
Returned Data Format	<nr2>
Query Example	LOAD:CR:CON:DC1:MAX? 0.3333
Query Syntax	LOAD:CR:CONductance:DC#:DEFault?
Description	Returns the default DC conductance setting value for the selected phase # or all phases if omitted.
Returned Data Format	<nr2>
Query Example	LOAD:CR:CON:DC1:DEF? 0.0000

<p>Command Syntax Description</p> <p>Parameters Parameter Format Example Query Format Returned Data Format Query Example</p>	<p>LOAD:CR:CONductance:DC#:USER:LIMit:MINimum <nr2> Sets the lower user limit for CR Load mode DC only conductance setting in Ohms for the selected phase # or all phases if omitted.</p> <p>Setting <nr2> LOAD:CR:CON:DC1:USER:LIM:MIN 0.100</p> <p>LOAD:CR:CONductance:DC#:USER:LIMit:MINimum? <nr2> LOAD:CR:CON:DC1:USER:LIM:MIN? 0.1000</p>
<p>Command Syntax Description</p> <p>Parameters Parameter Format Example Query Format Returned Data Format Query Example</p>	<p>LOAD:CR:CONductance:DC#:USER:LIMit:MAXimum <nr2> Sets the upper user limit for CR Load mode DC only conductance setting in Ohms for the selected phase # or all phases if omitted.</p> <p>Setting <nr2> LOAD:CR:CON:DC1:USER:LIM:MAX 10000.00</p> <p>LOAD:CR:CONductance:DC#:USER:LIMit:MAXimum? <nr2> LOAD:CR:CON:DC1:USER:LIM:MAX? 10000.0000</p>
<p>Query Syntax Description</p> <p>Returned Data Format Query Example</p>	<p>LOAD:CR:CONductance:DC#:USER:LIMit:RANGe? Returns the available setting range for the DC conductance user limit setting for the selected phase # or all phases if omitted.</p> <p><nr2>, <nr2> LOAD:CR:CON:DC3:USER:LIM:RANG? -0.3333, 0.3333</p>
<p>Query Syntax Description</p> <p>Returned Data Format Query Example</p>	<p>LOAD:CR:CONductance:DC#:RANGe:MINimum? Returns the minimum settable DC conductance Range setting value for the selected phase # or all phases if omitted.</p> <p><nr2> LOAD:CR:CON:DC1:RANG:MIN? -0.3333</p>
<p>Query Syntax Description</p> <p>Returned Data Format Query Example</p>	<p>LOAD:CR:CONductance:DC#:RANGe:MAXimum? Returns the maximum settable DC conductance Range setting value for the selected phase # or all phases if omitted.</p> <p><nr2> LOAD:CR:CON:DC1:RANG:MAX? 0.3333</p>

Query Syntax	LOAD:CR:CONductance:DC#:RANGe?
Description	Returns the Min and Max DC conductance Range setting values for the selected phase # or all phases if omitted.
Returned Data Format	<nr2>, <nr2>
Query Example	LOAD:CR:CON:DC#:RANG? -0.3333,0.3333
Command Syntax	LOAD:CR:CONductance:DC#:SLEW <nr2>
Description	Sets the CR Load mode DC conductance setting slew rate in Ohms per second for the selected phase # or all phases if omitted.
Parameters	Setting
Parameter Format	<nr2>
Example	LOAD:CR:CON:DC2:SLEW 100.00
Query Format	LOAD:CR:CONductance:DC#:SLEW?
Returned Data Format	<nr2>
Query Example	LOAD:CR:CON:AC2:SLEW? 100.0000
Query Syntax	LOAD:CR:CONductance:DC#:SLEW:MINimum?
Description	Returns the minimum settable DC conductance slew rate setting value for the selected phase # or all phases if omitted.
Returned Data Format	<nr2>
Query Example	LOAD:CR:CON:DC1:SLEW:MIN? 0.001
Query Syntax	LOAD:CR:CONductance:DC#:SLEW:MAXimum?
Description	Returns the maximum settable DC conductance slew rate setting value for the selected phase # or all phases if omitted.
Returned Data Format	<nr2>
Query Example	LOAD:CR:CON:DC1:SLEW:MAX? 1000.000
Query Syntax	LOAD:CR:CONductance:DC#:SLEW:DEFault?
Description	Returns the default DC conductance slew rate setting value for the selected phase # or all phases if omitted.
Returned Data Format	<nr2>
Query Example	LOAD:CR:CON:DC1:SLEW:DEF? 10.000

8.9.10 Load CP Mode Commands

These CP AC and DC commands operate as follows:

LOAD:CP:KVA commands are for:

(1) ACTIVE LOAD -> CONSTANT POWER -> APPARENT POWER RMS

- The DC setpoints produce a DC current that multiplied by the V_{rms} gives the desired KVA:DC.
- The AC setpoint produces an AC current (arbitrary or rectifier) that multiplied by the V_{rms} gives the desired KVA:AC.

So the difference is whether the load produces an AC and/or DC load condition to obtain the desired KVA.

LOAD:CP:POW commands are for:

(2) ACTIVE LOAD -> CONSTANT POWER -> ACTIVE POWER RMS

- The DC setpoints produce a DC current that multiplied by the V_{dc} gives the desired POW:DC.
- The AC setpoint produces an AC current (arbitrary or rectifier) that multiplied by the $V_{ac} \cdot \cos(\phi)$ gives the desired POW:AC.

(3) ACTIVE LOAD -> CONSTANT POWER -> INSTANT POWER

- The DC setpoints produce an instant current that multiplied by the $V(t)$ gives the desired instantaneous POW:DC.
- The AC setpoints produce an instant current that multiplied by the $V(t)$ gives the desired instantaneous arbitrary waveform of power.

Note: This Load mode of operation does **not** support the following functions:

- Interharmonics & Harmonics

<p>Query Syntax Description</p>	<p>LOAD:CP:TYPE#:CATalog? This command returns the available Constant Power Load type selections as a comma separated value list. 0 Apparent Power 1 Active Power 2 Instant Power</p>
<p>Returned Data Format Query Example</p>	<p><csv> LOAD:CP:TYPE:CAT? 0,Apparent Power RMS,1,Active Power RMS,2,Instant Power</p>
<p>Command Syntax Description</p>	<p>LOAD:CP:TYPE# <nr1> Sets the CP Load coupling type setting for the selected phase # or all phases if omitted. 0 AC 1 DC 2 AC & DC</p>
<p>Parameters Parameter Format Example Query Format Returned Data Format Query Example</p>	<p>0 1 2 <nr1> LOAD:CP:TYPE 2 LOAD:CP:TYPE#? <nr1> LOAD:CP:TYPE? 2</p>
<p>Query Syntax Description</p>	<p>LOAD:CP:MODE#:CATalog? This command returns the available Constant Power Load mode selections as a comma separated value list.</p>
<p>Returned Data Format Query Example</p>	<p><csv> LOAD:CP:MOD:CAT? 0,AC,1,DC,2,AC&DC</p>
<p>Command Syntax Description</p>	<p>LOAD:CP:MODE# <nr1> Sets the CP Load mode setting for the selected phase # or all phases if omitted.</p>
<p>Parameters Parameter Format Example Query Format Returned Data Format Query Example</p>	<p>CP mode <nr1>, <cr> LOAD:CP:MOD 2 LOAD:CP:MODE#? <nr1> LOAD:CP:MOD? 1,2,0</p>

<p>Command Syntax Description</p>	<p>LOAD:CP:POWer:AC# <nr2> Sets the CP Load mode AC power setting in kW for the selected phase # or all phases if omitted.</p>
<p>Parameters Parameter Format Example Query Format Returned Data Format Query Example</p>	<p>Setting <nr2> LOAD:CP:POW:AC1 10.000 LOAD:CP:POWer:AC#? <nr2> LOAD:CP:POW:AC1? 10.0000</p>
<p>Query Syntax Description</p>	<p>LOAD:CP:POWer:AC#:MINimum? Returns the minimum settable AC power setting value for the selected phase # or all phases if omitted.</p>
<p>Returned Data Format Query Example</p>	<p><nr2> LOAD:CP:POW:AC1:MIN? -17.2500</p>
<p>Query Syntax Description</p>	<p>LOAD:CP:POWer:AC#:MAXimum? Returns the maximum settable AC power setting value for the selected phase # or all phases if omitted.</p>
<p>Returned Data Format Query Example</p>	<p><nr2> LOAD:CP:POW:AC1:MAX? 17.2500</p>
<p>Query Syntax Description</p>	<p>LOAD:CP:POWer:AC#:DEFault? Returns the default AC power setting value for the selected phase # or all phases if omitted.</p>
<p>Returned Data Format Query Example</p>	<p><nr2> LOAD:CP:POW:AC1:DEF? 0.0000</p>
<p>Command Syntax Description</p>	<p>LOAD:CP:POWer:AC#:USER:LIMit:MINimum <nr2> Sets the lower user limit for CP Load mode AC power setting in kW for the selected phase # or all phases if omitted.</p>
<p>Parameters Parameter Format Example Query Format Returned Data Format Query Example</p>	<p>Setting <nr2> LOAD:CP:POW:AC1:USER:LIM:MIN 0.100 LOAD:CP:POWer:AC#:USER:LIMit:MINimum? <nr2> LOAD:CP:POW:AC1:USER:LIM:MIN? -17.2500</p>

<p>Command Syntax Description</p> <p>Parameters Parameter Format Example Query Format Returned Data Format Query Example</p>	<p>LOAD:CP:POW:AC#:USER:LIMit:MAXimum <nr2> Sets the upper user limit for CP Load mode AC power setting in kW for the selected phase # or all phases if omitted.</p> <p>Setting <nr2></p> <p>LOAD:CP:POW:AC1:USER:LIM:MAX 10000.00</p> <p>LOAD:CP:POW:AC#:USER:LIMit:MAXimum? <nr2></p> <p>LOAD:CP:POW:AC1:USER:LIM:MAX? 17.2500</p>
<p>Query Syntax Description</p> <p>Returned Data Format Query Example</p>	<p>LOAD:CP:POW:AC#:USER:LIMit:RANGe? Returns the available setting range for the AC power user limit setting for the selected phase # or all phases if omitted.</p> <p><nr2>, <nr2></p> <p>LOAD:CP:POW:AC3:USER:LIM:RANG? 0.1000, 10000.0000</p>
<p>Query Syntax Description</p> <p>Returned Data Format Query Example</p>	<p>LOAD:CP:POW:AC#:RANGe:MINimum? Returns the minimum settable AC power Range setting value for the selected phase # or all phases if omitted.</p> <p><nr2></p> <p>LOAD:CP:POW:AC1:RANG:MIN? -17.2500</p>
<p>Query Syntax Description</p> <p>Returned Data Format Query Example</p>	<p>LOAD:CP:POW:AC#:RANGe:MAXimum? Returns the maximum settable AC power Range setting value for the selected phase # or all phases if omitted.</p> <p><nr2></p> <p>LOAD:CP:POW:AC1:RANG:MAX? 17.2500</p>
<p>Query Syntax Description</p> <p>Returned Data Format Query Example</p>	<p>LOAD:CP:POW:AC#:RANGe? Returns the Min and Max AC power Range setting values for the selected phase # or all phases if omitted.</p> <p><nr2>, <nr2></p> <p>LOAD:CP:POW:AC#:RANG? -17.2500,17.2500</p>

<p>Command Syntax Description</p> <p>Parameters Parameter Format Example Query Format Returned Data Format Query Example</p>	<p>LOAD:CP:POWer:AC#:SLEW <nr2> Sets the CP Load mode AC power setting slew rate in kW per second for the selected phase # or all phases if omitted.</p> <p>Setting <nr2> LOAD:CP:POW:AC2:SLEW 100.00</p> <p>LOAD:CP:POWer:AC#:SLEW? <nr2> LOAD:CP:POW:AC2:SLEW? 100.0000</p>
<p>Query Syntax Description</p> <p>Returned Data Format Query Example</p>	<p>LOAD:CP:POWer:AC#:SLEW:MINimum? Returns the minimum settable AC power slew rate setting value for the selected phase # or all phases if omitted.</p> <p><nr2> LOAD:CP:POW:AC1:SLEW:MIN? 0.001</p>
<p>Query Syntax Description</p> <p>Returned Data Format Query Example</p>	<p>LOAD:CP:POWer:AC#:SLEW:MAXimum? Returns the maximum settable AC power slew rate setting value for the selected phase # or all phases if omitted.</p> <p><nr2> LOAD:CP:POW:AC1:SLEW:MAX? 1000.000</p>
<p>Query Syntax Description</p> <p>Returned Data Format Query Example</p>	<p>LOAD:CP:POWer:AC#:SLEW:DEFault? Returns the default AC power slew rate setting value for the selected phase # or all phases if omitted.</p> <p><nr2> LOAD:CP:POW:AC1:DEF? 10.0000</p>
<p>Command Syntax Description</p> <p>Parameters Parameter Format Example Query Format Returned Data Format Query Example</p>	<p>LOAD:CP:POWer:DC# <nr2> Sets the CP Load mode DC power setting in kW for the selected phase # or all phases if omitted.</p> <p>Setting <nr2> LOAD:CP:POW:DC1 10.000</p> <p>LOAD:CP:POWer:DC#? <nr2> LOAD:CP:POW:DC1? 10.0000</p>

Query Syntax	LOAD:CP:POWer:DC#:MINimum?
Description	Returns the minimum settable DC power setting value for the selected phase # or all phases if omitted.
Returned Data Format	<nr2>
Query Example	LOAD:CP:POW:DC1:MIN? -17.2500
Query Syntax	LOAD:CP:POWer:DC#:MAXimum?
Description	Returns the maximum settable DC power setting value for the selected phase # or all phases if omitted.
Returned Data Format	<nr2>
Query Example	LOAD:CP:POW:DC1:MAX? 17.2500
Query Syntax	LOAD:CP:POWer:DC#:DEFault?
Description	Returns the default DC power setting value for the selected phase # or all phases if omitted.
Returned Data Format	<nr2>
Query Example	LOAD:CP:POW:DC1:DEF? 0.0000
Command Syntax	LOAD:CP:POWer:DC#:USER:LIMit:MINimum <nr2>
Description	Sets the lower user limit for CP Load mode DC power setting in kW for the selected phase # or all phases if omitted.
Parameters	Setting
Parameter Format	<nr2>
Example	LOAD:CP:POW:DC1:USER:LIM:MIN 0.100
Query Format	LOAD:CP:POWer:DC#:USER:LIMit:MINimum?
Returned Data Format	<nr2>
Query Example	LOAD:CP:POW:DC1:USER:LIM:MIN? 0.1000
Command Syntax	LOAD:CP:POWer:DC#:USER:LIMit:MAXimum <nr2>
Description	Sets the upper user limit for CP Load mode DC power setting in kW for the selected phase # or all phases if omitted.
Parameters	Setting
Parameter Format	<nr2>
Example	LOAD:CP:POW:DC1:USER:LIM:MAX 10000.00
Query Format	LOAD:CP:POWer:DC#:USER:LIMit:MAXimum?
Returned Data Format	<nr2>
Query Example	LOAD:CP:POW:DC1:USER:LIM:MAX? 10000.0000

<p>Query Syntax Description</p> <p>Returned Data Format Query Example</p>	<p>LOAD:CP:POWer:DC#:USER:LIMit:RANGe? Returns the available setting range for the DC power user limit setting for the selected phase # or all phases if omitted.</p> <p><nr2>, <nr2> LOAD:CP:POW:DC3:USER:LIM:RANG? 0.1000, 10000.0000</p>
<p>Query Syntax Description</p> <p>Returned Data Format Query Example</p>	<p>LOAD:CP:POWer:DC#:RANGe:MINimum? Returns the minimum settable DC power Range setting value for the selected phase # or all phases if omitted.</p> <p><nr2> LOAD:CP:POW:DC1:RANG:MIN? 0.1000</p>
<p>Query Syntax Description</p> <p>Returned Data Format Query Example</p>	<p>LOAD:CP:POWer:DC#:RANGe:MAXimum? Returns the maximum settable DC power Range setting value for the selected phase # or all phases if omitted.</p> <p><nr2> LOAD:CP:POWer:DC1:RANG:MAX? 10000.0000</p>
<p>Query Syntax Description</p> <p>Returned Data Format Query Example</p>	<p>LOAD:CP:POWer:DC#:RANGe? Returns the Min and Max DC power Range setting values for the selected phase # or all phases if omitted.</p> <p><nr2>, <nr2> LOAD:CP:POW:DC#:RANG? 0.1000, 10.0000</p>
<p>Command Syntax Description</p> <p>Parameters Parameter Format Example Query Format Returned Data Format Query Example</p>	<p>LOAD:CP:POWer:DC#:SLEW <nr2> Sets the CP Load mode DC power setting slew rate in kW per second for the selected phase # or all phases if omitted.</p> <p>Setting <nr2> LOAD:CP:POW:DC2:SLEW 100.00</p> <p>LOAD:CP:POWer:DC#:SLEW? <nr2> LOAD:CP:POW:DC2:SLEW? 100.0000</p>
<p>Query Syntax Description</p> <p>Returned Data Format Query Example</p>	<p>LOAD:CP:POWer:DC#:SLEW:MINimum? Returns the minimum settable DC power slew rate setting value for the selected phase # or all phases if omitted.</p> <p><nr2> LOAD:CP:POW:DC1:SLEW:MIN? 0.001</p>

<p>Query Syntax Description</p> <p>Returned Data Format Query Example</p>	<p>LOAD:CP:POWER:DC#:SLEW:MAXimum? Returns the maximum settable DC power slew rate setting value for the selected phase # or all phases if omitted.</p> <p><nr2> LOAD:CP:POW:DC1:SLEW:MAX? 1000.000</p>
<p>Query Syntax Description</p> <p>Returned Data Format Query Example</p>	<p>LOAD:CP:POWer:DC#:SLEW:DEFault? Returns the default DC power slew rate setting value for the selected phase # or all phases if omitted.</p> <p><nr2> LOAD:CP:POW:DC1:DEF? 10.000</p>
<p>Command Syntax Description</p> <p>Parameters Parameter Format Example Query Format Returned Data Format Query Example</p>	<p>LOAD:CP:KVA:AC# <nr2> Sets the CP Load mode AC apparent power setting in kVA for the selected phase # or all phases if omitted.</p> <p>Setting <nr2> LOAD:CP:POW:AC1 10.000</p> <p>LOAD:CP:KVA:AC#? <nr2> LOAD:CP:KVA:AC1? 10.0000</p>
<p>Query Syntax Description</p> <p>Returned Data Format Query Example</p>	<p>LOAD:CP:KVA:AC#:MINimum? Returns the minimum settable AC apparent power setting value for the selected phase # or all phases if omitted.</p> <p><nr2> LOAD:CP:KVA:AC1:MIN? - 17.2500</p>
<p>Query Syntax Description</p> <p>Returned Data Format Query Example</p>	<p>LOAD:CP:KVA:AC#:MAXimum? Returns the maximum settable AC apparent power setting value for the selected phase # or all phases if omitted.</p> <p><nr2> LOAD:CP:KVA:AC1:MAX? 17.2500</p>
<p>Query Syntax Description</p> <p>Returned Data Format Query Example</p>	<p>LOAD:CP:KVA:AC#:DEFault? Returns the default AC apparent power setting value for the selected phase # or all phases if omitted.</p> <p><nr2> LOAD:CP:KVA:AC1:DEF? 0.0000</p>

Command Syntax	LOAD:CP:KVA:AC#:USER:LIMit:MINimum <nr2>
Description	Sets the lower user limit for CP Load mode AC apparent power setting in kVA for the selected phase # or all phases if omitted.
Parameters	Setting
Parameter Format	<nr2>
Example	LOAD:CP:KVA:AC1:USER:LIM:MIN 0.100
Query Format	LOAD:CP:KVA:AC#:USER:LIMit:MINimum?
Returned Data Format	<nr2>
Query Example	LOAD:CP:KVA:AC1:USER:LIM:MIN? 0.1000
Command Syntax	LOAD:CP:KVA:AC#:USER:LIMit:MAXimum <nr2>
Description	Sets the upper user limit for CP Load mode AC apparent power setting in kVA for the selected phase # or all phases if omitted.
Parameters	Setting
Parameter Format	<nr2>
Example	LOAD:CP:KVA:AC1:USER:LIM:MAX 10000.00
Query Format	LOAD:CP:KVA:AC#:USER:LIMit:MAXimum?
Returned Data Format	<nr2>
Query Example	LOAD:CP:KVA:AC1:USER:LIM:MAX? 10000.0000
Query Syntax	LOAD:CP:KVA:AC#:USER:LIMit:RANGe?
Description	Returns the available setting range for the AC apparent power user limit setting for the selected phase # or all phases if omitted.
Returned Data Format	<nr2>, <nr2>
Query Example	LOAD:CP:KVA:AC3:USER:LIM:RANG? 0.1000, 10000.0000
Query Syntax	LOAD:CP:KVA:AC#:RANGe:MINimum?
Description	Returns the minimum settable AC apparent power range setting value for the selected phase # or all phases if omitted.
Returned Data Format	<nr2>
Query Example	LOAD:CP:KVA:AC1:RANG:MIN? -17.2500
Query Syntax	LOAD:CP:KVA:AC#:RANGe:MAXimum?
Description	Returns the maximum settable AC apparent power range setting value for the selected phase # or all phases if omitted.
Returned Data Format	<nr2>
Query Example	LOAD:CP:KVA:AC1:RANG:MAX? 17.2500

Query Syntax	LOAD:CP:KVA:AC#:RANGe?
Description	Returns the Min and Max AC apparent power range setting values for the selected phase # or all phases if omitted.
Returned Data Format	<nr2>, <nr2>
Query Example	LOAD:CP:KVA:AC#:RANG? -17.2500,17.2500
Command Syntax	LOAD:CP:KVA:AC#:SLEW <nr2>
Description	Sets the CP Load mode AC apparent power setting slew rate in kVA per second for the selected phase # or all phases if omitted.
Parameters	Setting
Parameter Format	<nr2>
Example	LOAD:CP:KVA:AC2:SLEW 100.00
Query Format	LOAD:CP:KVA:AC#:SLEW?
Returned Data Format	<nr2>
Query Example	LOAD:CP:KVA:AC2:SLEW? 100.0000
Query Syntax	LOAD:CP:KVA:AC#:SLEW:MINimum?
Description	Returns the minimum settable AC apparent power slew rate setting value for the selected phase # or all phases if omitted.
Returned Data Format	<nr2>
Query Example	LOAD:CP:KVA:AC1:SLEW:MIN? 0.001
Query Syntax	LOAD:CP:KVA:AC#:SLEW:MAXimum?
Description	Returns the maximum settable AC apparent power slew rate setting value for the selected phase # or all phases if omitted.
Returned Data Format	<nr2>
Query Example	LOAD:CP:KVA:AC1:SLEW:MAX? 1000.000
Query Syntax	LOAD:CP:KVA:AC#:SLEW:DEFault?
Description	Returns the default AC apparent power slew rate setting value for the selected phase # or all phases if omitted.
Returned Data Format	<nr2>
Query Example	LOAD:CP:KVA:AC1:DEF? 10.000

<p>Command Syntax Description</p> <p>Parameters Parameter Format Example Query Format Returned Data Format Query Example</p>	<p>LOAD:CP:KVA:DC# <nr2> Sets the CP Load mode DC apparent power setting in kVA for the selected phase # or all phases if omitted.</p> <p>Setting <nr2> LOAD:CP:POW:AC1 10.000</p> <p>LOAD:CP:KVA:DC#? <nr2> LOAD:CP:KVA:DC1? 10.0000</p>
<p>Query Syntax Description</p> <p>Returned Data Format Query Example</p>	<p>LOAD:CP:KVA:DC#:MINimum? Returns the minimum settable DC apparent power setting value for the selected phase # or all phases if omitted.</p> <p><nr2> LOAD:CP:KVA:DC1:MIN? -17.2500</p>
<p>Query Syntax Description</p> <p>Returned Data Format Query Example</p>	<p>LOAD:CP:KVA:DC#:MAXimum? Returns the maximum settable DC apparent power setting value for the selected phase # or all phases if omitted.</p> <p><nr2> LOAD:CP:KVA:DC1:MAX? 17.2500</p>
<p>Query Syntax Description</p> <p>Returned Data Format Query Example</p>	<p>LOAD:CP:KVA:DC#:DEFault? Returns the default DC apparent power setting value for the selected phase # or all phases if omitted.</p> <p><nr2> LOAD:CP:KVA:DC1:DEF? 0.000</p>
<p>Command Syntax Description</p> <p>Parameters Parameter Format Example Query Format Returned Data Format Query Example</p>	<p>LOAD:CP:KVA:DC#:USER:LIMit:MINimum <nr2> Sets the lower user limit for CP Load mode DC apparent power setting in kVA for the selected phase # or all phases if omitted.</p> <p>Setting <nr2> LOAD:CP:KVA:DC1:USER:LIM:MIN 0.100</p> <p>LOAD:CP:KVA:DC#:USER:LIMit:MINimum? <nr2> LOAD:CP:KVA:DC1:USER:LIM:MIN? 0.1000</p>

Command Syntax	LOAD:CP:KVA:DC#:USER:LIMit:MAXimum <nr2>
Description	Sets the upper user limit for CP Load mode DC apparent power setting in kVA for the selected phase # or all phases if omitted.
Parameters	Setting
Parameter Format	<nr2>
Example	LOAD:CP:KVA:DC1:USER:LIM:MAX 10000.00
Query Format	LOAD:CP:KVA:DC#:USER:LIMit:MAXimum?
Returned Data Format	<nr2>
Query Example	LOAD:CP:KVA:DC1:USER:LIM:MAX? 10000.0000
Query Syntax	LOAD:CP:KVA:DC#:USER:LIMit:RANGe?
Description	Returns the available setting range for the DC apparent power user limit setting for the selected phase # or all phases if omitted.
Returned Data Format	<nr2>, <nr2>
Query Example	LOAD:CP:KVA:DC3:USER:LIM:RANG? 0.1000, 10000.0000
Query Syntax	LOAD:CP:KVA:DC#:RANGe:MINimum?
Description	Returns the minimum settable DC apparent power range setting value for the selected phase # or all phases if omitted.
Returned Data Format	<nr2>
Query Example	LOAD:CP:KVA:DC1:RANG:MIN? -17.2500
Query Syntax	LOAD:CP:KVA:DC#:RANGe:MAXimum?
Description	Returns the maximum settable DC apparent power range setting value for the selected phase # or all phases if omitted.
Returned Data Format	<nr2>
Query Example	LOAD:CP:KVA:DC1:RANG:MAX? 17.2500,
Query Syntax	LOAD:CP:KVA:DC#:RANGe?
Description	Returns the Min and Max DC apparent power range setting values for the selected phase # or all phases if omitted.
Returned Data Format	<nr2>, <nr2>
Query Example	LOAD:CP:KVA:DC#:RANG? -17.2500,17.2500

Command Syntax	LOAD:CP:KVA:DC#:SLEW <nr2>
Description	Sets the CP Load mode DC apparent power setting slew rate in kVA per second for the selected phase # or all phases if omitted.
Parameters	Setting
Parameter Format	<nr2>
Example	LOAD:CP:KVA:DC2:SLEW 100.00
Query Format	LOAD:CP:KVA:DC#:SLEW?
Returned Data Format	<nr2>
Query Example	LOAD:CP:KVA:DC2:SLEW? 100.0000
Query Syntax	LOAD:CP:KVA:DC#:SLEW:MINimum?
Description	Returns the minimum settable DC apparent power slew rate setting value for the selected phase # or all phases if omitted.
Returned Data Format	<nr2>
Query Example	LOAD:CP:KVA:DC1:SLEW:MIN? 0.001
Query Syntax	LOAD:CP:KVA:DC#:SLEW:MAXimum?
Description	Returns the maximum settable DC apparent power slew rate setting value for the selected phase # or all phases if omitted.
Returned Data Format	<nr2>
Query Example	LOAD:CP:KVA:DC1:SLEW:MAX? 1000.0000
Query Syntax	LOAD:CP:KVA:DC#:SLEW:DEFault?
Description	Returns the default DC apparent power slew rate setting value for the selected phase # or all phases if omitted.
Returned Data Format	<nr2>
Query Example	LOAD:CP:KVA:DC1:DEF? 10.000

8.9.11 Load Circuit Emulation Commands

Note: This Load mode of operation does **not** support the following functions:

- Transient Programming
- Analog Programming
- Interharmonics & Harmonics
- User Selectable Waveforms
- Phase Rotation setting
- User Limit settings
- Ramp & Slew modes

Query Syntax	LOAD:CE:TYPE#:CATalog?
Description	This command returns the available Circuit Emulation Load type selections as a comma separated value list. 0 R 1 Series RL 2 Series RC 3 R // Series RL 4 R // Series RC 5 R (L // C) 6 L (R // C) 7 C (R // L) 8 Series RLC 9 R // Series RLC 10 Series RL // Series RC 11 R // Series RL // Series RC 12 Series RL (R // C) 13 Rectifier Single Phase 14 Rectifier Three Phase
Returned Data Format	<csv>
Query Example	LOAD:CE:TYPE:CAT? 0,R,1,Series RL,2,Series RC,3,R // Series RL,4,R // Series RC,5,R (L // C),6,L (R // C),7,C (R // L),8,Series RLC,9,R // Series RLC,10,Series RL // Series RC,11,R // Series RL // Series RC,12,Series RL (R // C),13,Rectifier Single Phase,14,Rectifier Three Phase
Command Syntax	LOAD:CE:TYPE# <nr1>
Description	Sets the Circuit Emulation (CE) Load type setting for the selected phase # or all phases if omitted.
Parameters	Type
Parameter Format	<nr1>, <cr>
Example	LOAD:CE:TYPE 2
Query Format	LOAD:CE:TYPE#?
Returned Data Format	<nr1>
Query Example	LOAD:CE:TYPE? 2,0,0

Command Syntax	LOAD:CE[:STATe]# <0 OFF 1 ON>
Description	Enables or Disables the CE Load mode setting for the selected phase # or all phases if omitted.
Parameters	0 OFF 1 ON
Parameter Format	 or <cr>
Example	LOAD:CE 0
Query Format	LOAD:CE #?
Returned Data Format	
Query Example	LOAD:CE? 0,0,0
Command Syntax	LOAD:CE:R# <nr2>
Description	Sets the Circuit Emulation (CE) Load mode resistance setting in Ohms for the selected phase # or all phases if omitted.
Parameters	Setting
Parameter Format	<nr2>
Example	LOAD:CE:R 1.258
Query Format	LOAD:CE:R#?
Returned Data Format	<nr2>
Query Example	LOAD:CE:R? 1.2580
Query Syntax	LOAD:CE:R:MINimum?
Description	Returns the minimum settable resistance setting value for the selected phase # or all phases if omitted.
Returned Data Format	<nr2>
Query Example	LOAD:CE:R1:MIN? 0.000000
Query Syntax	LOAD:CE:R#:MAXimum?
Description	Returns the maximum settable resistance setting value for the selected phase # or all phases if omitted.
Returned Data Format	<nr2>
Query Example	LOAD:CE:R1:MAX? 1000000.000000
Query Syntax	LOAD:CE:R#:DEFault?
Description	Returns the default resistance setting value for the selected phase # or all phases if omitted.
Returned Data Format	<nr2>
Query Example	LOAD:CE:R1:DEF? 10.000000

<p>Command Syntax Description</p> <p>Parameters Parameter Format Example Query Format Returned Data Format Query Example</p>	<p>LOAD:CE:RC# <nr2> Sets the Circuit Emulation (CE) Load mode resistance + capacitance setting in Ohms for the selected phase # or all phases if omitted.</p> <p>Setting <nr2> LOAD:CE:RC 1.258</p> <p>LOAD:CE:RC#? <nr2> LOAD:CE:RC? 1.2580</p>
<p>Query Syntax Description</p> <p>Returned Data Format Query Example</p>	<p>LOAD:CE:RC#:MINimum? Returns the minimum settable series resistance + capacitance setting value for the selected phase # or all phases if omitted.</p> <p><nr2> LOAD:CE:RC1:MIN? -100000.0000</p>
<p>Query Syntax Description</p> <p>Returned Data Format Query Example</p>	<p>LOAD:CE:RC#:MAXimum? Returns the maximum settable series resistance + capacitance setting value for the selected phase # or all phases if omitted.</p> <p><nr2> LOAD:CE:RC1:MAX? 100000.0000</p>
<p>Query Syntax Description</p> <p>Returned Data Format Query Example</p>	<p>LOAD:CE:RC#:DEFault? Returns the default series resistance + capacitance setting value for the selected phase # or all phases if omitted.</p> <p><nr2> LOAD:CE:RC1:DEF? 10.0000</p>
<p>Command Syntax Description</p> <p>Parameters Parameter Format Example Query Format Returned Data Format Query Example</p>	<p>LOAD:CE:RL# <nr2> Sets the Circuit Emulation (CE) Load mode resistance + inductance setting in Ohms for the selected phase # or all phases if omitted.</p> <p>Setting <nr2> LOAD:CE:RL 1.258</p> <p>LOAD:CE:RL#? <nr2> LOAD:CE:RL? 1.2580</p>

<p>Query Syntax Description</p>	<p>LOAD:CE:RL#:MINimum? Returns the minimum settable series resistance + inductance setting value for the selected phase # or all phases if omitted.</p>
<p>Returned Data Format Query Example</p>	<p><nr2> LOAD:CE:RL1:MIN? 0.000000</p>
<p>Query Syntax Description</p>	<p>LOAD:CE:RL#:MAXimum? Returns the maximum settable series resistance + inductance setting value for the selected phase # or all phases if omitted.</p>
<p>Returned Data Format Query Example</p>	<p><nr2> LOAD:CE:RL1:MAX? 1000000.000000</p>
<p>Query Syntax Description</p>	<p>LOAD:CE:RL#:DEFault? Returns the default series resistance + inductance setting value for the selected phase # or all phases if omitted.</p>
<p>Returned Data Format Query Example</p>	<p><nr2> LOAD:CE:RC1:DEF? 0.001000</p>
<p>Command Syntax Description</p>	<p>LOAD:CE:L# <nr2> Sets the Circuit Emulation (CE) Load mode inductance setting in mH for the selected phase # or all phases if omitted.</p>
<p>Parameters Parameter Format Example Query Format Returned Data Format Query Example</p>	<p>Setting <nr2> LOAD:CE:L 1.258 LOAD:CE:L#? <nr2> LOAD:CE:L? 1.2580</p>
<p>Query Syntax Description</p>	<p>LOAD:CE:L:MINimum? Returns the minimum settable inductance setting value for the selected phase # or all phases if omitted.</p>
<p>Returned Data Format Query Example</p>	<p><nr2> LOAD:CE:L1:MIN? 0.00000000</p>
<p>Query Syntax Description</p>	<p>LOAD:CE:L#:MAXimum? Returns the maximum settable inductance setting value for the selected phase # or all phases if omitted.</p>
<p>Returned Data Format Query Example</p>	<p><nr2> LOAD:CE:L1:MAX? 100.00000000</p>

Query Syntax	LOAD:CE:L#:DEFault?
Description	Returns the default inductance setting value for the selected phase # or all phases if omitted.
Returned Data Format	<nr2>
Query Example	LOAD:CE:L1:DEF? 0.00100000
Command Syntax	LOAD:CE:C# <nr2>
Description	Sets the Circuit Emulation (CE) Load mode capacitance setting in uF for the selected phase # or all phases if omitted.
Parameters	Setting
Parameter Format	<nr2>
Example	LOAD:CE:C 1.258
Query Format	LOAD:CE:C#?
Returned Data Format	<nr2>
Query Example	LOAD:CE:C? 1.2580
Query Syntax	LOAD:CE:C:MINimum?
Description	Returns the minimum settable capacitance setting value for the selected phase # or all phases if omitted.
Returned Data Format	<nr2>
Query Example	LOAD:CE:C1:MIN? 0.00000000
Query Syntax	LOAD:CE:C#:MAXimum?
Description	Returns the maximum settable capacitance setting value for the selected phase # or all phases if omitted.
Returned Data Format	<nr2>
Query Example	LOAD:CE:C1:MAX? 0.10000000
Query Syntax	LOAD:CE:C#:DEFault?
Description	Returns the default capacitance setting value for the selected phase # or all phases if omitted.
Returned Data Format	<nr2>
Query Example	LOAD:CE:C1:DEF? 0.00100000

Command Syntax	LOAD:CE:C#:VINITial <nr2>
Description	Sets the Circuit Emulation (CE) Load mode Voltage initialization setting in Vpeak for the selected phase # or all phases if omitted.
Parameters	Setting
Parameter Format	<nr2>
Example	LOAD:CE:VINIT 300.0
Query Format	LOAD:CE:C#:VINITial?
Returned Data Format	<nr2>
Query Example	LOAD:CE:VINIT? 300.0000
Query Syntax	LOAD:CE:C#:VINITial MINimum?
Description	Returns the minimum settable Voltage initialization setting value for the selected phase # or all phases if omitted.
Returned Data Format	<nr2>
Query Example	LOAD:CE:C:VINIT:MIN? -2000.0000
Query Syntax	LOAD:CE:C#:VINITial MAXimum?
Description	Returns the maximum settable Voltage initialization setting value for the selected phase # or all phases if omitted.
Returned Data Format	<nr2>
Query Example	LOAD:CE:C:VINIT:MAX? 2000.0000
Query Syntax	LOAD:CE:C#:VINITial:DEFault?
Description	Returns the default Voltage initialization setting value for the selected phase # or all phases if omitted.
Returned Data Format	<nr2>
Query Example	LOAD:CE:C1:VINIT:DEF? 0.0000

8.9.12 Transient Inrush Current Mode Commands

Note: The commands in this section apply only to the following operating models:

- Current source
- Active load:
 - Constant current, sync and no sync
 - Constant resistance
 - Resistance RMS
 - Conductance RMS
 - Constant power
 - Active power RMS
 - Apparent power RMS

Refer to section 3.7.5, “Inrush Current Simulation Mode” on page 38 for more information on this special transient mode.

Command Syntax	[SOURCE:]INRUsh:EDIT:MODE
Description	This command allows choosing the way to build the inrush transient depending on the user's needs.
Parameters	<REQ: 0 CFRMS 1 CFPEAK 2 PEAKRMS> 0 CFRMS: Crest factor and RMS values. (Default selection). 1 CFPEAK: Crest factor and Peak values. 2 PEAKRMS: Peak and RMS values.
Parameter Format	<nr1> <cr>
Example	INRU:EDIT:MODE CFRMS
Query Format	[SOURCE:]INRUsh:EDIT:MODE?
Returned Data Format	<nr1>
Query Example	INRU:EDIT:MODE? 1
Query Format	[SOURCE:]INRUsh:EDIT:MODE:CATalog?
Description	This command returns the available mode settings for an inrush transient.
Returned Data Format	<nr1>,<cr>,...,<nr1>,<cr>
Return Value	0,CF & RMS: Crest factor and RMS values. (Default selection). 1,CF & PEAK: Crest factor and Peak values. 2,PEAK & RMS: Peak and RMS values.
Query Example	INRU:EDIT:MODE:CAT? 0,CF & RMS,1,CF & PEAK,2,PEAK & RMS

Command Syntax	[SOURce:]INRUsh[:PROGram]:MODE
Description	This command sets the programming mode for an inrush transient.
Parameters	<REQ: 0 INIDEL 1 FINDEL 2 INIFIN> 0 INIDEL: Allows programming the inrush by initial and delta values 1 FINDEL: Allows programming the inrush by final and delta values 2 INIFIN: Allows programming the inrush by initial and final values
Parameter Format	<cr> <nr1>
Example	INRU:PROG:MODE INIDEL
Query Format	[SOURce:]INRUsh[:PROGram]:MODE?
Returned Data Format	<nr1>
Query Example	INRU:PROG:MODE? 1
Query Format	[SOURce:]INRUsh[:PROGram]:MODE:CATalog?
Description	This command returns the available mode settings for an inrush transient.
Returned Data Format	<nr1>, <cr>, ..., <nr1>, <cr>
Return Value	0 Initial and delta: Allows programming the inrush by initial and delta values 1 Final and delta: Allows programming the inrush by final and delta values 2 Initial and final: Allows programming the inrush by initial and final values
Query Example	INRU:PROG:MODE:CAT? 0,Initial and delta,1,Final and delta,2,Initial and final
Command Syntax	[SOURce:]INRUsh:CYCLES
Description	This command sets the number of cycles that the transient will generate.
Parameters	<REQ: CYCLES NUMBER>
Parameter Format	<nr1>
Example	INRU:CYCLE
Query Format	[SOURce:]INRUsh:CYCLES?
Returned Data Format	<nr1>
Query Example	INRU:CYCLE? 5
Query Format	[SOURce:]INRUsh:CYCLES:MINimum?
Description	This command returns the lowest value allowed for cycles. Minimum value is 1.
Returned Data Format	<nr1>
Return Value	1
Query Example	INRU:CYCLE:MIN? 1

Query Format **[SOURce:]INRUsh:CYCLEs:MAXimum?**
Description This command returns the highest value allowed for cycles. Maximum value is 10.
Returned Data Format <nr1>
Return Value 10
Query Example INRU:CYCLE:MAX?
 10

Query Format **[SOURce:]INRUsh:CYCLEs:DEFault?**
Description This value returns the value set by default. Default value is 10.
Returned Data Format <nr1>
Return Value 10
Query Example INRU:CYCLE:DEF?
 10

Command Syntax **[SOURce:]INRUsh:REPeat**
Description This command sets the number of repeat times for the transient.
Parameters <REQ: CYCLES NUMBER>
Parameter Format <nr1>
Example INRU:REP 100
Query Format **[SOURce:]INRUsh:REPeat?**
Returned Data Format <nr1>
Query Example INRU:REP?
 100

Query Format **[SOURce:]INRUsh:REPeat:MINimum?**
Description This command returns the lowest value allowed for repeats. Minimum value is 0.
Returned Data Format <nr1>
Return Value 1
Query Example INRU:REP:MIN?
 1

Query Format **[SOURce:]INRUsh:REPeat:MAXimum?**
Description This command returns the highest value allowed for repeats. Maximum value is 65535.
Returned Data Format <nr1>
Return Value 65535
Query Example INRU:REP:MAX?
 65535

Query Format	[SOURce:]INRUsh:REPeat:DEFault?
Description	This value returns the value set by default. Default value is 1.
Returned Data Format	<nr1>
Return Value	1
Query Example	INRU:REP:DEF? 1
Command Syntax	[SOURce:]INRUsh:FORM
Description	This command configures different waveform modes to use in an inrush transient. The possibilities are waveforms with one peak or two peaks.
Parameters	<REQ: 0 AUTO 1 ONEPEAK 2 TWOPEAK> 0 AUTO: In this mode the waveform will depend on the SOUR:FORM setting. If the unit is configured as three-phase then the inrush waveform will be two peaks, otherwise one peak. (Default selection). 1 ONEPEAK: Force waveform with one peak. 2 TWOPEAK: Force waveform with two peaks.
Parameter Format	<cr> or <nr1>
Example	INRU:FORM AUTO
Query Format	[SOURce:]INRUsh:FORM?
Returned Data Format	<nr1>
Query Example	INRU:FORM? 0
Query Format	[SOURce:]INRUsh:FORM:CATalog?
Description	This command returns the available form mode settings for an inrush transient. 0 Auto: In this mode the waveform will depend on the SOUR:FORM setting. If the unit is configured as three-phase then the inrush waveform will be two peaks, otherwise one peak. (Default selection). 1 One Peak: Force waveform with one peak. 2 Two Peak: Force waveform with two peaks.
Returned Data Format	<nr1>, <cr>, ..., <nr1>, <cr>
Return Value	0,Auto,1,One Peak,2,Two Peak
Query Example	INRU:PROG:FORM:CAT? 0,Auto,1,One Peak,2,Two Peak

<p>Command Syntax Description</p>	<p>[SOURCE:]INRUsh:HOLD</p> <p>This command determines what happens to the source output after the step transient finishes. If ON, the last step value will be set as the steady state output when the step execution ends. If OFF, the output will revert to the original steady state setting in effect before the step transient execution.</p>
<p>Parameters Parameter Format Example Query Format Returned Data Format Query Example</p>	<p><REQ: 0 OFF 1 ON></p> <p><nr1> or <cr></p> <p>INRU:HOLD ON</p> <p>[SOURCE:]INRUsh:HOLD ?</p> <p></p> <p>INRU:HOLD?</p> <p>0.0</p>
<p>Command Syntax Description</p>	<p>[SOURCE:]INRUsh:CF:INITial#</p> <p>This command sets the initial crest factor value for selected phase # or for all phases if phase reference is omitted.</p> <p><u>Note 1:</u> Execution error: Not allowed command with the current configuration.</p> <p>If you get this error, check the INRU:PROG:MODE.</p> <p><u>Note 2:</u> Parameter above minimum/maximum unit scope.</p> <p>If you get this error, check the min or max range for this parameter.</p>
<p>Parameters Parameter Format Example Query Format Returned Data Format Query Example</p>	<p><REQ: CF PHASE A, OPT: CF PHASE B, OPT: CF PHASE C></p> <p><nr2> <nr2>, <nr2>, <nr2></p> <p>NRU:CF:INIT 3.1</p> <p>INRU:CF:INIT 3.1,3.1,3.1</p> <p>[SOURCE:]INRUsh:CF:INITial#?</p> <p><nr2> <nr2>, <nr2>, <nr2></p> <p>INRU:CF:INIT1?</p> <p>4.0</p>
<p>Query Format Description</p>	<p>[SOURCE:]INRUsh:CF:INITial#:MINimum?</p> <p>This command returns the minimum permissible set value for the initial inrush CF for selected phase # or for all phases if phase reference is omitted.</p>
<p>Returned Data Format Return Value Query Example</p>	<p><nr2> <nr2>, <nr2>, <nr2></p> <p>1.0</p> <p>INRU:CF:INIT1:MIN?</p> <p>1.0</p>

Query Format Description	[SOURCE:]INRUsh:CF:INITial#:MAXimum? This command returns the maximum permissible set value for the initial inrush CF for selected phase # or for all phases if phase reference is omitted.
Returned Data Format Return Value Query Example	<nr2> <nr2>, <nr2>, <nr2> 1.0 INRU:CF:INIT1:MAX? 10.0
Query Format Description	[SOURCE:]INRUsh:CF:INITial#:DEFault? This command returns the default value for the initial inrush CF for selected phase # or for all phases if phase reference is omitted.
Returned Data Format Return Value Query Example	<nr2> 1.0 INRU:CF:INIT1:DEF? 1.0
Command Syntax Description	[SOURCE:]INRUsh:CF:FINal# This command sets the final crest factor value for selected phase # or for all phases if phase reference is omitted. <u>Note:</u> Execution error: Not allowed command with the current configuration. If you get this error, check the INRU:PROG:MODE. <u>Note:</u> Parameter above minimum/maximum unit scope. If you get this error, check the min or max range for this parameter.
Parameters Parameter Format Example	<REQ: CF PHASE A, OPT: CF PHASE B, OPT: CF PHASE C> <nr2> <nr2>, <nr2>, <nr2> INRU:CF:FIN 8.0 INRU:CF:FIN 8.0,8.0,8.0
Query Format Returned Data Format Query Example	[SOURCE:]INRUsh:CF:FINal#? <nr2> <nr2>, <nr2>, <nr2> INRU:CF:FIN1? 4.0
Query Format Description	[SOURCE:]INRUsh:CF:FINal#:MINimum? This command returns the minimum permissible set value for the final inrush CF for selected phase # or for all phases if phase reference is omitted.
Returned Data Format Return Value Query Example	<nr2> <nr2>, <nr2>, <nr2> 1.0 INRU:CF:FIN1:MIN? 1.0

Query Format Description	[SOURCE:]INRUsh:CF:FINal#:MAXimum? This command returns the maximum permissible set value for the final inrush CF for selected phase # or for all phases if phase reference is omitted.
Returned Data Format Return Value Query Example	<nr2> <nr2>, <nr2>, <nr2> 10.0 INRU:CF:FIN1:MAX? 10.0
Query Format Description	[SOURCE:]INRUsh:CF:FINal#:DEFault? This command returns the default value for the final inrush CF for selected phase # or for all phases if phase reference is omitted.
Returned Data Format Return Value Query Example	<nr2> 1.0 INRU:CF:FIN1:DEF? 1.0
Command Syntax Description	[SOURCE:]INRUsh:CF:DELTa# This command sets the delta crest factor value for selected phase # or for all phases if phase reference is omitted. <u>Note:</u> Execution error: Not allowed command with the current configuration. If you get this error, check the INRU:PROG:MODE. <u>Note:</u> Parameter above minimum/maximum unit scope. If you get this error, check the min or max range for this parameter.
Parameters Parameter Format Example	<REQ: CF PHASE A, OPT: CF PHASE B, OPT: CF PHASE C> <nr2> <nr2>, <nr2>, <nr2> INRU:CF:DELT 8.0 INRU:CF:DELT 8.0,8.0,8.0
Query Format Returned Data Format Query Example	[SOURCE:]INRUsh:CF:DELTa#? <nr2> <nr2>, <nr2>, <nr2> INRU:CF:DELT1? 2.0
Query Format Description	[SOURCE:]INRUsh:CF:DELTa#:MINimum? This command returns the minimum permissible set value for the delta inrush CF for selected phase # or for all phases if phase reference is omitted.
Returned Data Format Return Value Query Example	<nr2> <nr2>, <nr2>, <nr2> 1.0 INRU:CF:DELT1:MIN? 1.0

Query Format Description	[SOURCE:]INRUsh:CF:DELTA#:MAXimum? This command returns the maximum permissible set value for the delta inrush CF for selected phase # or for all phases if phase reference is omitted.
Returned Data Format Return Value Query Example	<nr2> <nr2>, <nr2>, <nr2> 10.0 INRU:CF:DELT1:MAX? 10.0
Query Format Description	[SOURCE:]INRUsh:CF:DELTA #:DEFault? This command returns the default value for the delta inrush CF for selected phase # or for all phases if phase reference is omitted.
Returned Data Format Return Value Query Example	<nr2> 0.0 INRU:CF:DELT1:DEF? 0.0
Command Syntax Description	[SOURCE:]INRUsh:FREQuency:INITial This command sets the initial inrush frequency. <u>Note:</u> Execution error: Not allowed command with the current configuration. If you get this error, check the INRU:PROG:MODE. <u>Note:</u> Parameter above minimum/maximum unit scope. If you get this error, check the min or max range for this parameter.
Parameters Parameter Format Example Query Format Returned Data Format Query Example	<REQ:FREQ> <nr2> INRU:FREQ:INIT 15.0 [SOURCE:]INRUsh:FREQuency:INITial? <nr2> INRU:FREQ:INIT? 60.0
Query Format Description	[SOURCE:]INRUsh:FREQuency:INITial:MINimum? This command returns the minimum permissible set value for the initial inrush frequency.
Returned Data Format Return Value Query Example	<nr2> 15.0 INRU:FREQ:INIT:MIN? 15.0

Query Format **[SOURCE:]INRUsh:FREQuency:INITial:MAXimum?**
 Description This command returns the maximum permissible set value for the initial inrush frequency.
 Returned Data Format <nr2>
 Return Value 1000.0
 Query Example INRU:FREQ:INIT:MAX?
 1000.0

Query Format **[SOURCE:]INRUsh:FREQuency:INITial:DEFault?**
 Description This command returns the default value for the initial inrush frequency.
 Returned Data Format <nr2>
 Return Value 60.0
 Query Example INRU:FREQ:INIT:DEF?
 60.0

Command Syntax **[SOURCE:]INRUsh:FREQuency:FINal**
 Description This command sets the final inrush frequency.
Note:
Execution error: Not allowed command with the current configuration.
 If you get this error, check the INRU:PROG:MODE.
Note:
Parameter above minimum/maximum unit scope.
 If you get this error, check the min or max range for this parameter.
 Parameters <REQ: FREQ>
 Parameter Format <nr2>
 Example INRU:FREQ:FIN 200.0
 Query Format <nr2>
 Returned Data Format **[SOURCE:]INRUsh:FREQuency:FINal?**
 Query Example INRU:FREQ:FIN?
 60.0

Query Format **[SOURCE:]INRUsh:FREQuency:FINal:MINimum?**
 Description This command returns the minimum permissible set value for the final inrush frequency.
 Returned Data Format <nr2>
 Return Value 15.0
 Query Example INRU:FREQ:FIN:MIN?
 15.0

Query Format	[SOURce:]INRUsh:FREQuency:FINal:MAXimum?
Description	This command returns the maximum permissible set value for the final inrush frequency.
Returned Data Format	<nr2>
Return Value	1000.0
Query Example	INRU:FREQ:FIN:MAX? 1000.0
Query Format	[SOURce:]INRUsh:FREQuency:FINal:DEFault?
Description	This command returns the default value for the final inrush frequency.
Returned Data Format	<nr2>
Return Value	60.0
Query Example	INRU:FREQ:FIN:DEF? 60.0
Command Syntax	[SOURce:]INRUsh:FREQuency:DELTA
Description	This command sets the delta inrush frequency. <u>Note:</u> Execution error: Not allowed command with the current configuration. If you get this error, check the INRU:PROG:MODE. <u>Note:</u> Parameter above minimum/maximum unit scope. If you get this error, check the min or max range for this parameter.
Parameters	<REQ: FREQ>
Parameter Format	<nr2>
Example	INRU:FREQ:DELT 10.0
Query Format	[SOURce:]INRUsh:FREQuency:DELTA?
Returned Data Format	<nr2>
Query Example	INRU:FREQ:DELT? 60.0
Query Format	[SOURce:]INRUsh:FREQuency:DELTA:MINimum?
Description	This command returns the minimum permissible set value for the delta inrush frequency.
Returned Data Format	<nr2>
Return Value	15.0
Query Example	INRU:FREQ:DELT:MIN? 15.0

<p>Query Format Description</p> <p>Returned Data Format Return Value Query Example</p>	<p>[SOURCE:]INRUsh:FREQuency:DELTA:MAXimum?</p> <p>This command returns the maximum permissible set value for the delta inrush frequency.</p> <p><nr2> 1000.0 INRU:FREQ:DELTA:MAX? 1000.0</p>
<p>Command Syntax Description</p> <p>Parameters Parameter Format Example</p> <p>Query Format Returned Data Format Query Example</p>	<p>[SOURCE:]INRUsh:PHASe:INITial#</p> <p>This command sets the initial inrush phase angle for selected phase # or for all phases if phase reference is omitted.</p> <p><u>Note:</u> Execution error: Not allowed command with the current configuration. If you get this error, check the INRU:PROG:MODE.</p> <p><u>Note:</u> Parameter above minimum/maximum unit scope. If you get this error, check the min or max range for this parameter.</p> <p><REQ: PHASE ANGLE A, OPT: PHASE ANGLE B, OPT: PHASE ANGLE C> <nr2> <nr2>, <nr2>, <nr2> NRU:PHAS:INIT1 0.0 INRU:PHAS:INIT 0.0,180.0,240.0</p> <p>[SOURCE:]INRUsh:PHASe:INITial#? <nr2> <nr2>, <nr2>, <nr2> INRU:PHAS:INIT1? 0.0</p>
<p>Query Format Description</p> <p>Returned Data Format Return Value Query Example</p>	<p>[SOURCE:]INRUsh:PHASe:INITial#:MINimum?</p> <p>This command returns the minimum permissible set value for the initial inrush phase angle for selected phase # or for all phases if phase reference is omitted.</p> <p><nr2> <nr2>, <nr2>, <nr2> -99999.0 INRU:PHAS:INIT1:MIN? -99999.0</p>
<p>Query Format Description</p> <p>Returned Data Format Return Value Query Example</p>	<p>[SOURCE:]INRUsh:PHASe:INITial#:MAXimum?</p> <p>This command returns the maximum permissible set value for the initial inrush phase angle for selected phase # or for all phases if phase reference is omitted.</p> <p><nr2> <nr2>, <nr2>, <nr2> 99999.0 INRU:PHAS:INIT1:MAX? 99999.0</p>

Query Format Description	[SOURCE:]INRUsh:PHASe:INITial#:DEFault? This command returns the default value for the initial inrush phase angle for selected phase # or for all phases if phase reference is omitted. <u>Note:</u> Execution error: Not allowed command with the current configuration. If you get this error, check the INRU:PROG:MODE. <u>Note:</u> Parameter above minimum/maximum unit scope. If you get this error, check the min or max range for this parameter.
Returned Data Format Return Value Query Example	<nr2> 0.0 INRU:PHAS:INIT1:DEF? 0.0
Command Syntax Description	[SOURCE:]INRUsh:PHASe:FINal# This command sets the final inrush phase angle for selected phase # or for all phases if phase reference is omitted. <u>Note:</u> Execution error: Not allowed command with the current configuration. If you get this error, check the INRU:PROG:MODE. <u>Note:</u> Parameter above minimum/maximum unit scope. If you get this error, check the min or max range for this parameter.
Parameters Parameter Format Example	<REQ: PHASE ANGLE A, OPT: PHASE ANGLE B, OPT: PHASE ANGLE C> <nr2> <nr2>, <nr2>, <nr2> INRU:PHAS:FIN 180.0 INRU:PHAS:FIN 180.0,160.0,140.0
Query Format Returned Data Format Query Example	[SOURCE:]INRUsh:PHASe:FINal#? <nr2> <nr2>, <nr2>, <nr2> INRU:PHAS:FIN1? 0.0
Query Format Description	[SOURCE:]INRUsh:PHASe:FINal#:MINimum? This command returns the minimum permissible set value for the final inrush phase angle for selected phase # or for all phases if phase reference is omitted.
Returned Data Format Return Value Query Example	<nr2> <nr2>, <nr2>, <nr2> -99999.0 INRU:PHAS:FIN1:MIN? -99999.0

Query Format Description	[SOURCE:]INRUsh:PHASe:FINal#:MAXimum? This command returns the maximum permissible set value for the final inrush phase angle for selected phase # or for all phases if phase reference is omitted.
Returned Data Format Return Value Query Example	<nr2> <nr2>, <nr2>, <nr2> 99999.0 INRU:PHAS:FIN1:MAX? 99999.0
Query Format Description	[SOURCE:]INRUsh:PHASe:FINal#:DEFault? This command returns the default value for the final inrush phase angle for selected phase # or for all phases if phase reference is omitted.
Returned Data Format Return Value Query Example	<nr2> 0.0 INRU:PHAS:FIN1:DEF? 0.0
Command Syntax Description	[SOURCE:]INRUsh:PHASe:DELTa# This command sets the delta inrush phase angle for selected phase # or for all phases if phase reference is omitted. <u>Note:</u> Execution error: Not allowed command with the current configuration. If you get this error, check the INRU:PROG:MODE. <u>Note:</u> Parameter above minimum/maximum unit scope. If you get this error, check the min or max range for this parameter.
Parameters Parameter Format Example	<REQ: PHASE ANGLE A, OPT: PHASE ANGLE B, OPT: PHASE ANGLE C> <nr2> <nr2>, <nr2>, <nr2> INRU:PHAS:DELT1 0.0 INRU:PHAS:DELT 0.0,160.0,140.0
Query Format Returned Data Format Query Example	[SOURCE:]INRUsh:PHASe:DELT#? <nr2> <nr2>, <nr2>, <nr2> INRU:PHAS:FIN1? 0.0
Query Format Description	[SOURCE:]INRUsh:PHASe:DELTa#:MINimum? This command returns the minimum permissible set value for the delta inrush phase angle for selected phase # or for all phases if phase reference is omitted.
Returned Data Format Return Value Query Example	<nr2> <nr2>, <nr2>, <nr2> -99999.0 INRU:PHAS:DELT1:MIN? -99999.0

Query Format Description	[SOURCE:]INRUsh:PHASe:DELTA#:MAXimum? This command returns the maximum permissible set value for the delta inrush phase angle for selected phase # or for all phases if phase reference is omitted.
Returned Data Format Return Value Query Example	<nr2> <nr2>, <nr2>, <nr2> 99999.0 INRU:PHAS:DELT1:MAX? 99999.0
Query Format Description	[SOURCE:]INRUsh:PHASe:DELTA#:DEFault? This command returns the default value for the delta inrush phase angle for selected phase # or for all phases if phase reference is omitted.
Returned Data Format Return Value Query Example	<nr2> 0.0 INRU:PHAS:DELT:DEF? 0.0
Command Syntax Description	[SOURCE:]INRUsh:CURRENT:PEAK:INITial# This command sets the initial inrush peak current value for selected phase # or for all phases if phase reference is omitted. <u>Note:</u> Execution error: Not allowed command with the current configuration. If you get this error, check the INRU:PROG:MODE. <u>Note:</u> Parameter above minimum/maximum unit scope. If you get this error, check the min or max range for this parameter.
Parameters	<REQ: CURRENT PEAK A, OPT: CURRENT PEAK B, OPT: CURRENT PEAK C>
Parameter Format Example	<nr2> <nr2>, <nr2>, <nr2> INRU:CURR:PEAK:INIT1 10.0 INRU:CURR:PEAK:INIT 10.0,12.0,15.0
Query Format Returned Data Format Query Example	[SOURCE:]INRUsh:CURRENT:PEAK:INITial#? <nr2> <nr2>, <nr2>, <nr2> INRU:CURR:PEAK:INIT1? 10.0
Query Format Description	[SOURCE:]INRUsh:CURRENT:PEAK:INITial#:MINimum? This command returns the minimum permissible set value for the initial inrush peak current for selected phase # or for all phases if phase reference is omitted.
Returned Data Format Return Value Query Example	<nr2> <nr2>, <nr2>, <nr2> -130.0 INRU:CURR:PEAK:INIT1:MIN? -130.0

Query Format Description	[SOURCE:]INRUsh:CURRENT:PEAK:INITial#:MAXimum? This command returns the maximum permissible set value for the initial inrush peak current for selected phase # or for all phases if phase reference is omitted.
Returned Data Format Return Value Query Example	<nr2> <nr2>, <nr2>, <nr2> 130.0 INRU:CURR:PEAK:INIT1:MAX? 130.0
Query Format Description	[SOURCE:]INRUsh:CURRENT:PEAK:INITial#:DEFault? This command returns the default value for the initial inrush peak current for selected phase # or for all phases if phase reference is omitted.
Returned Data Format Return Value Query Example	<nr2> 0.0 INRU:CURR:PEAK:INIT1:DEF? 0.0
Command Syntax Description	[SOURCE:]INRUsh:CURRENT:PEAK:FINal# This command sets the final inrush peak current value for selected phase # or for all phases if phase reference is omitted. <u>Note:</u> Execution error: Not allowed command with the current configuration. If you get this error, check the INRU:PROG:MODE. <u>Note:</u> Parameter above minimum/maximum unit scope. If you get this error, check the min or max range for this parameter.
Parameters	<REQ: CURRENT PEAK A, OPT: CURRENT PEAK B, OPT: CURRENT PEAK C>
Parameter Format Example	<nr2> <nr2>, <nr2>, <nr2> INRU:CURR:PEAK:FIN1 2.0 INRU:CURR:PEAK:FIN 2.0,2.0,2.0
Query Format Returned Data Format Query Example	[SOURCE:]INRUsh:CURRENT:PEAK:FINal#? <nr2> <nr2>, <nr2>, <nr2> INRU:CURR:PEAK:FIN1? 2.0
Query Format Description	[SOURCE:]INRUsh:CURRENT:PEAK:FINal#:MINimum? This command returns the minimum permissible set value for the final inrush peak current for selected phase # or for all phases if phase reference is omitted
Returned Data Format Return Value Query Example	<nr2> <nr2>, <nr2>, <nr2> -130.0 INRU:CURR:PEAK:FIN1:MIN? -130.0

<p>Query Format</p> <p>Description</p>	<p>[SOURCE:]INRUsh:CURRENT:PEAK:FINal#:MAXimum?</p> <p>This command returns the maximum permissible set value for the final inrush peak current for selected phase # or for all phases if phase reference is omitted</p>
<p>Returned Data Format</p> <p>Return Value</p> <p>Query Example</p>	<p><nr2> <nr2>, <nr2>, <nr2></p> <p>130.0</p> <p>INRU:CURR:PEAK:FIN1:MAX?</p> <p>130.0</p>
<p>Query Format</p> <p>Description</p>	<p>[SOURCE:]INRUsh:CURRENT:PEAK:FINal#:DEFault?</p> <p>This command returns the default value for the final inrush peak current for selected phase # or for all phases if phase reference is omitted.</p>
<p>Returned Data Format</p> <p>Return Value</p> <p>Query Example</p>	<p><nr2></p> <p>0.0</p> <p>INRU:CURR:PEAK:FIN1:DEF?</p> <p>0.0</p>
<p>Command Syntax</p> <p>Description</p>	<p>[SOURCE:]INRUsh:CURRENT:PEAK:DELTA#</p> <p>This command sets the delta inrush peak current value for selected phase # or for all phases if phase reference is omitted.</p> <p><u>Note:</u> Execution error: Not allowed command with the current configuration. If you get this error, check the INRU:PROG:MODE.</p> <p><u>Note:</u> Parameter above minimum/maximum unit scope. If you get this error, check the min or max range for this parameter.</p>
<p>Parameters</p>	<p><REQ: CURRENT PEAK A, OPT: CURRENT PEAK B, OPT: CURRENT PEAK C></p>
<p>Parameter Format</p> <p>Example</p>	<p><nr2> <nr2>, <nr2>, <nr2></p> <p>NRU:CURR:PEAK:DELT1 0.5</p> <p>INRU:CURR:PEAK:DELT 1.0,1.5,2.0</p>
<p>Query Format</p> <p>Returned Data Format</p> <p>Query Example</p>	<p>[SOURCE:]INRUsh:CURRENT:PEAK:DELTA#?</p> <p><nr2> <nr2>, <nr2>, <nr2></p> <p>INRU:CURR:PEAK:DELT1?</p> <p>1.0</p>
<p>Query Format</p> <p>Description</p>	<p>[SOURCE:]INRUsh:CURRENT:PEAK:DELTA#:MINimum?</p> <p>This command returns the minimum permissible set value for the delta inrush peak current for selected phase # or for all phases if phase reference is omitted</p>
<p>Returned Data Format</p> <p>Return Value</p> <p>Query Example</p>	<p><nr2> <nr2>, <nr2>, <nr2></p> <p>-130.0</p> <p>INRU:CURR:PEAK:DELT1:MIN?</p> <p>-130.0</p>

<p>Query Format</p> <p>Description</p>	<p>[SOURCE:]INRUsh:CURRENT:PEAK:DELTA#:MAXimum?</p> <p>This command returns the maximum permissible set value for the delta inrush peak current for selected phase # or for all phases if phase reference is omitted</p>
<p>Returned Data Format</p> <p>Return Value</p> <p>Query Example</p>	<p><nr2> <nr2>, <nr2>, <nr2></p> <p>130.0</p> <p>INRU:CURR:PEAK:DELT1:MAX?</p> <p>130.0</p>
<p>Query Format</p> <p>Description</p>	<p>[SOURCE:]INRUsh:CURRENT:PEAK:DELTA#:DEFault?</p> <p>This command returns the default value for the delta inrush peak current for selected phase # or for all phases if phase reference is omitted.</p>
<p>Returned Data Format</p> <p>Return Value</p> <p>Query Example</p>	<p><nr2></p> <p>0.0</p> <p>INRU:CURR:PEAK:DELT1:DEF?</p> <p>0.0</p>
<p>Command Syntax</p> <p>Description</p>	<p>[SOURCE:]INRUsh:CURRENT[:AC][:INITial]#</p> <p>This command sets the initial inrush AC current value for selected phase # or for all phases if phase reference is omitted.</p> <p><u>Note:</u> Execution error: Not allowed command with the current configuration. If you get this error, check the INRU:PROG:MODE.</p> <p><u>Note:</u> Parameter above minimum/maximum unit scope. If you get this error, check the min or max range for this parameter.</p>
<p>Parameters</p> <p>Parameter Format</p> <p>Example</p>	<p><REQ: AC CURRENT A, OPT: AC CURRENT B, OPT: AC CURRENT C></p> <p><nr2> <nr2>, <nr2>, <nr2></p> <p>INRU:CURR:AC:INIT1 10.0</p> <p>INRU:CURR:AC:INIT 10.0,12.0,15.0</p>
<p>Query Format</p> <p>Returned Data Format</p> <p>Query Example</p>	<p>[SOURCE:]INRUsh:CURRENT[:AC][:INITial]#?</p> <p><nr2> <nr2>, <nr2>, <nr2></p> <p>INRU:CURR:AC:INIT1?</p> <p>10.0</p>
<p>Query Format</p> <p>Description</p>	<p>[SOURCE:]INRUsh:CURRENT[:AC][:INITial]#:MINimum?</p> <p>This command returns the minimum permissible set value for the initial inrush AC current for selected phase # or for all phases if phase reference is omitted.</p>
<p>Returned Data Format</p> <p>Return Value</p> <p>Query Example</p>	<p><nr2> <nr2>, <nr2>, <nr2></p> <p>-130</p> <p>INRU:CURR:AC:INIT1:MIN?</p> <p>-130.0</p>

<p>Query Format Description</p> <p>Returned Data Format Return Value Query Example</p>	<p>[SOURCE:]INRUsh:CURRENT[:AC][:INITIAL]#:MAXIMUM?</p> <p>This command returns the maximum permissible set value for the initial inrush AC current for selected phase # or for all phases if phase reference is omitted.</p> <p><nr2> <nr2>, <nr2>, <nr2></p> <p>130</p> <p>INRU:CURR:AC:INIT1:MAX?</p> <p>130.0</p>
<p>Query Format Description</p> <p>Returned Data Format Return Value Query Example</p>	<p>[SOURCE:]INRUsh:CURRENT[:AC][:INITIAL]#:DEFAULT?</p> <p>This command returns the default value for the initial inrush AC current for selected phase # or for all phases if phase reference is omitted.</p> <p><nr2></p> <p>0.0</p> <p>INRU:CURR:AC:INIT1:DEF?</p> <p>0.0</p>
<p>Command Syntax Description</p>	<p>[SOURCE:]INRUsh:CURRENT[:AC:]FINAL#</p> <p>This command sets the final inrush AC current value for selected phase # or for all phases if phase reference is omitted.</p> <p><u>Note:</u> Execution error: Not allowed command with the current configuration. If you get this error, check the INRU:PROG:MODE.</p> <p><u>Note:</u> Parameter above minimum/maximum unit scope. If you get this error, check the min or max range for this parameter.</p>
<p>Parameters Parameter Format Example</p>	<p><REQ: AC CURRENT A, OPT: AC CURRENT B, OPT: AC CURRENT C></p> <p><nr2> <nr2>, <nr2>, <nr2></p> <p>INRU:CURR:AC:FIN1 2.0</p> <p>INRU:CURR:AC:FIN 2.0,2.0,2.0</p>
<p>Query Format Returned Data Format Query Example</p>	<p>[SOURCE:]INRUsh:CURRENT[:AC:]FINAL#?</p> <p><nr2> <nr2>, <nr2>, <nr2></p> <p>INRU:CURR:AC:FIN1?</p> <p>2.0</p>
<p>Query Format Description</p> <p>Returned Data Format Return Value Query Example</p>	<p>[SOURCE:]INRUsh:CURRENT[:AC:]FINAL#:MINIMUM?</p> <p>This command returns the minimum permissible set value for the final inrush AC current for selected phase # or for all phases if phase reference is omitted.</p> <p><nr2> <nr2>, <nr2>, <nr2></p> <p>-130</p> <p>INRU:CURR:AC:FIN1:MIN?</p> <p>-130.0</p>

Query Format Description	[SOURCE:]INRUsh:CURRENT:[AC:]FINal#:MAXimum? This command returns the maximum permissible set value for the final inrush AC current for selected phase # or for all phases if phase reference is omitted.
Returned Data Format Return Value Query Example	<nr2> <nr2>, <nr2>, <nr2> 130 INRU:CURR:AC:FIN1:MAX? 130.0
Query Format Description	[SOURCE:]INRUsh:CURRENT:[AC:]FINal#:DEFault? This command returns the default value for the final inrush AC current for selected phase # or for all phases if phase reference is omitted.
Returned Data Format Return Value Query Example	<nr2> 0.0 INRU:CURR:AC:FIN1:DEF? 0.0
Command Syntax Description	[SOURCE:]INRUsh:CURRENT:[AC:]DELTA# This command sets the delta inrush AC current value for selected phase # or for all phases if phase reference is omitted. <u>Note:</u> Execution error: Not allowed command with the current configuration. If you get this error, check the INRU:PROG:MODE. <u>Note:</u> Parameter above minimum/maximum unit scope. If you get this error, check the min or max range for this parameter.
Parameters Parameter Format	<REQ: AC CURRENT A, OPT: AC CURRENT B, OPT: AC CURRENT C> <nr2> <nr2>, <nr2>, <nr2>
Example	INRU:CURR:AC:DELT1 0.5 INRU:CURR:AC:DELT 1.0,1.5,2.0
Query Format Returned Data Format Query Example	[SOURCE:]INRUsh:CURRENT:[AC:]DELTA#? <nr2> <nr2>, <nr2>, <nr2> INRU:CURR:AC:DELT1? 1.0
Query Format Description	[SOURCE:]INRUsh:CURRENT:[AC:]DELTA#:MINimum? This command returns the minimum permissible set value for the delta inrush AC current for selected phase # or for all phases if phase reference is omitted.
Returned Data Format Return Value Query Example	<nr2> <nr2>, <nr2>, <nr2> -130 INRU:CURR:AC:DELT1:MIN? -130.000

Query Format	[SOURce:]INRUsh:CURRent:[AC:]DELTA#:MAXimum?
Description	This command returns the maximum permissible set value for the delta inrush AC current for selected phase # or for all phases if phase reference is omitted.
Returned Data Format	<nr2> <nr2>, <nr2>, <nr2>
Return Value	130
Query Example	INRU:CURR:AC:DELT1:MAX? 130.000
Query Format	[SOURce:]INRUsh:CURRent:[AC:]DELTA #:DEFault?
Description	This command returns the default value for the delta inrush AC current for selected phase # or for all phases if phase reference is omitted.
Returned Data Format	<nr2>
Return Value	0.0
Query Example	INRU:CURR:AC:DELT1:DEF? 0.0
Command Syntax	[SOURce:]INRUsh
Description	>>> <i>Alias for PROGram:TRANSient command.</i> <<<
Parameters	This command controls inrush transient execution
Parameter Format	<REQ: RUN STOP PAUSe STEP REStart>
Example	INRUSH RUN
Query Format	[SOURce:]INRUsh?
Returned Data Format	Return values respresent running state as follows: 0: Stopped 1: Running 2: Paused 3: Stepping 4: Waiting for trigger
Query Example	INRU? 1
Command Syntax	[SOURce:]INRUsh:LOAD
Description	This command converts the inrush transient definition to the power source's regular transient segment format and loads it in the controller real-time memory for execution.
Parameters	None
Parameter Format	n/a
Example	INRU:LOAD
Query Format	[SOURce:]INRUsh:LOAD?
Returned Data Format	<nr1> 0: Load Failed 1: Load completed
Query Example	INRU:LOAD? 1

Query Format	[SOURCE:]INRUsh:PROGress?
Description	>>> <i>Alias for PROGRAM:TRANSient:PROGress command.</i> <<< This query command returns the status of the inrush being executed.
Returned Data Format	None
Return Value	<cr> The response is a comma-separated value string representing: PROGRESS, CURRENT SEGMENT PROGRESS, CURRENT SEGMENT, CURRENT SEGMENT TIME, ELEMENT TO EXECUTE, TOTAL TIME, TOTAL SEGMENTS, REPEAT TIME COUNTER
Query Example	INRU:PROG? 78,72,21,242,21,8333,26,1
Query Format	[SOURCE:]INRUsh:CHECK?
Description	This query command returns the result of a check on the programmed inrush parameters to determine if they are ok to run.
Returned Data Format	<cr>
Return Value	The response is either OK or if not, a string containing the error.
Query Example	INRU:CHECK? OK
Query Format	[SOURCE:]INRUsh:ALL?
Description	This query command returns a comma-separated values string of the entire inrush parameters, settings, and limits. Each set value is preceded by a tag identifying the parameter. This same data structure is used for front panel display and by the web server. The advantage is that this command returns all inrush related information using just one query command.
Returned Data Format	<cr>
Return Value	
Query Example	INRU:ALL? form,3,loaded,1,status,0,hold,0,progress,0,current element progress,.....
Command Syntax	[SOURCE:]INRUsh:EXPDECayfactor
Description	This exponential decay factor controls how quickly the inrush current decays. A higher factor makes it disappear faster.
Parameters	<REQ: FACTOR VALUE>
Parameter Format	<nr2>
Example	INRU:EXPDEC 5.0
Query Format	[SOURCE:]INRUsh:EXPDECayfactor?
Returned Data Format	<nr2>
Query Example	INRU:EXPDEC? 5.0

Query Format	[SOURCE:]INRUsh:EXPDECayfactor:MINimum?
Description	This command returns the minimum permissible set value for the exponential decay factor.
Returned Data Format	<nr2>
Return Value	0.0
Query Example	INRU:EXPDEC:MIN? 0.0
Query Format	[SOURCE:]INRUsh:EXPDECayfactor:MAXimum?
Description	This command returns the maximum permissible set value for the exponential decay factor.
Returned Data Format	<nr2>
Return Value	10.0
Query Example	INRU:EXPDEC:MAX? 10.0
Query Format	[SOURCE:]INRUsh:EXPDECayfactor:DEFault?
Description	This command returns the default value for the exponential decay factor.
Returned Data Format	<nr2>
Return Value	1.0
Query Example	INRU:EXPDEC:DEF? 1.0
Command Syntax	[SOURCE:]INRUsh:STEADYstatetime
Description	This command allows adding a new segment at the end of the transient, with configurable time, and automatically adopts the values of the last programmed inrush segment. If the time is 0, it is disabled.
Parameters	<REQ: S. STATE TIME VALUE>
Parameter Format	<nr2>
Example	INRU:STEADY 0.5
Query Format	[SOURCE:]INRUsh:STEADYstatetime?
Returned Data Format	<nr2>
Query Example	INRU:STEADY? 0.5
Query Format	[SOURCE:]INRUsh:STEADYstatetime:MINimum?
Description	This command returns the minimum permissible set value for the steady state time
Returned Data Format	<nr2>
Return Value	0.0
Query Example	INRU:STEADY:MIN? 0.0

Query Format **[SOURCE:]INRUsh:STEADYstatetime:MAXimum?**
 Description This command returns the maximum permissible set value for the steady state time
 Returned Data Format <nr2>
 Return Value 10000.0
 Query Example INRU:STEADY:MAX?
 10000.0

Query Format **[SOURCE:]INRUsh:STEADYstatetime:DEFault?**
 Description This command returns the default value for the steady state time
 Returned Data Format <nr2>
 Return Value 0.1
 Query Example INRU:STEADY:DEF?
 0.1

Command Syntax **[SOURCE:]INRUsh:PFC:SIMulation**
 Description This command turns on the simulation of the PFC to simulate a system commonly observed in practice. It adds a new sine waveform segment to the end of the last programmed inrush segment with the previously configured parameters.
 Parameters <REQ 1 | ON | 0 | OFF>
 Parameter Format <nr1> | <cr>
 Example INRU:PFC:SIM 1
 Query Format **[SOURCE:]INRUsh:PFC:SIMulation?**
 Returned Data Format 0: PFC simulation disabled.
 1: PFC simulation enabled.
 Query Example INRU:PFC:SIM?
 1

Command Syntax **[SOURCE:]INRUsh:PFC:RAMPtime**
 Description This command allows configure the PFC simulation ramp time duration.
 Parameters <REQ: PFC RAMP TIME VALUE>
 Parameter Format <nr2>
 Example INRU:PFC:RAMP 0.1
 Query Format **[SOURCE:]INRUsh:PFC:RAMPtime?**
 Returned Data Format <nr2>
 Query Example INRU:PFC:RAMP?
 0.1

Query Format **[SOURCE:]INRUsh:PFC:RAMPtime:MINimum?**
 Description This command returns the minimum permissible set value for the PFC ramp time duration.
 Returned Data Format <nr2>
 Return Value 0.0
 Query Example INRU:PFC:RAMP:MIN?
 0.0

Query Format	[SOURCE:]INRUsh:PFC:RAMPtime:MAXimum?
Description	This command returns the maximum permissible set value for the PFC ramp time duration.
Returned Data Format	<nr2>
Return Value	10000.0
Query Example	INRU:PFC:RAMP:MAX? 10000.0
Query Format	[SOURCE:]INRUsh:PFC:RAMPtime:DEFault?
Description	This command returns the default value for the PFC ramp time duration.
Returned Data Format	<nr2>
Return Value	0.1
Query Example	INRU:PFC:RAMP:DEF? 0.1
Command Syntax	[SOURCE:]INRUsh:PFC:TURNontime
Description	This command allows to configure a delay time before running the PFC simulation. This includes a new segment in the transient list with the last added waveform.
Parameters	<REQ: PFC TURN ON TIME VALUE>
Parameter Format	<nr2>
Example	INRU:PFC:TURN 0.1
Query Format	[SOURCE:]INRUsh:PFC:TURNontime?
Returned Data Format	<nr2>
Query Example	INRU:PFC:TURN? 0.1
Query Format	[SOURCE:]INRUsh:PFC:TURNontime:MINimum?
Description	This command returns the minimum permissible set value for the PFC turn on time.
Returned Data Format	<nr2>
Return Value	0.0
Query Example	INRU:PFC:TURN:MIN? 0.0
Query Format	[SOURCE:]INRUsh:PFC:TURNontime:MAXimum?
Description	This command returns the maximum permissible set value for the PFC turn on time.
Returned Data Format	<nr2>
Return Value	10000.0
Query Example	INRU:PFC:TURN:MAX? 10000.0

Query Format	[SOURCE:]INRUsh:PFC:TURNontime:DEFault?
Description	This command returns the default value for the PFC turn on time.
Returned Data Format	<nr2>
Return Value	0.1
Query Example	INRU:PFC:TURN:DEF? 0.1
Command Syntax	[SOURCE:]INRUsh:PFC:CURRENT[:AC]#
Description	This command allows to configure the PFC simulation AC current value for selected phase # or for all phases if phase reference is omitted.
Parameters	<REQ: PFC AC CURRENT A, OPT: PFC AC CURRENT B, OPT: PFC AC CURRENT C >
Parameter Format	<nr2> <nr2>, <nr2>, <nr2>
Example	INRU:PFC:CURR:AC1 10.0 INRU:PFC:CURR:AC 10.0, 10.0, 10.0
Query Format	[SOURCE:]INRUsh:PFC:CURRENT[:AC]#?
Returned Data Format	<nr2>
Query Example	INRU:PFC:CURR:AC1? 10.0
Query Format	[SOURCE:]INRUsh:PFC:CURRENT[:AC]#:MINimum?
Description	This command returns the minimum permissible set value for AC current of PFC simulation.
Returned Data Format	<nr2>
Return Value	-130.0
Query Example	INRU:PFC:CURR:AC1:MIN? -130.0
Query Format	[SOURCE:]INRUsh:PFC:CURRENT[:AC]#:MAXimum?
Description	This command returns the maximum permissible set value for AC current of PFC simulation.
Returned Data Format	<nr2>
Return Value	130.0
Query Example	INRU:PFC:CURR:AC1:MAX? 130.0
Query Format	[SOURCE:]INRUsh:PFC:CURRENT[:AC]#:DEFault?
Description	This command returns the default value for AC current of PFC simulation.
Returned Data Format	<nr2>
Return Value	0.0
Query Example	INRU:PFC:CURR:AC1:DEF? 0.0

8.9.13 High Impedance Mode Commands

The AZX has a high impedance mode with a programmed voltage threshold. When the threshold is reached the AZX realizes that it is in high impedance and regulates its voltage to zero. When it detects voltage again it exits this mode and starts acting as load again.

This mode allows the AZX to stay enabled or to enable its output in high impedance/open circuit conditions when used as an electronic load.

Note: This mode is not enabled by default because any voltage spike can cause the AZX to enter this mode and exit it quickly. This may be confusing and not desired by the user depending on the application.

Below image shows an example of the disconnection of the AZX. Note the peak on the voltage before the AZX enters the high impedance mode.

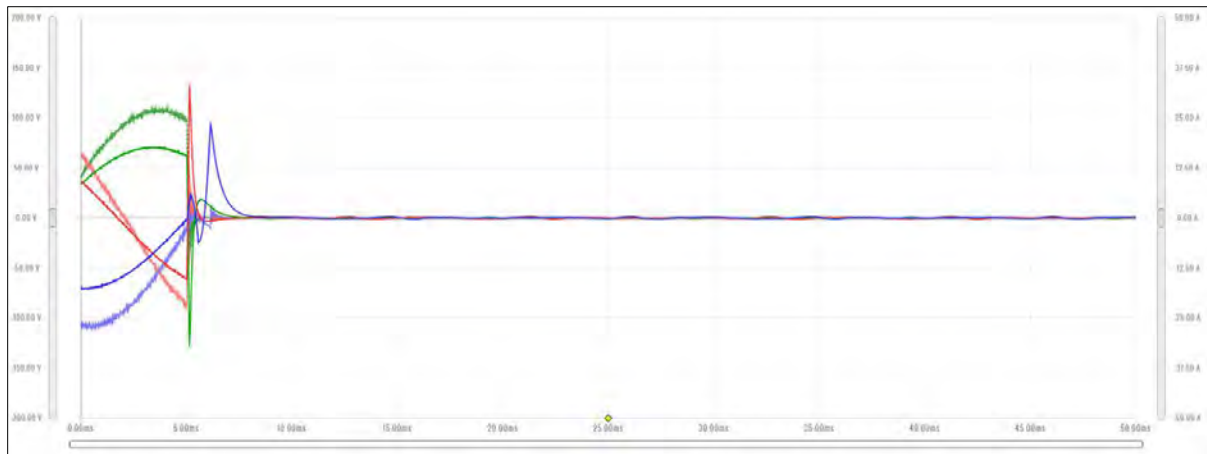

This is an example of the connection of the load – exists high impedance mode when it detects the AC input voltage being applied.

Note: This uses the fast sync mode – see section 8.9.2 on page 418 for reference.

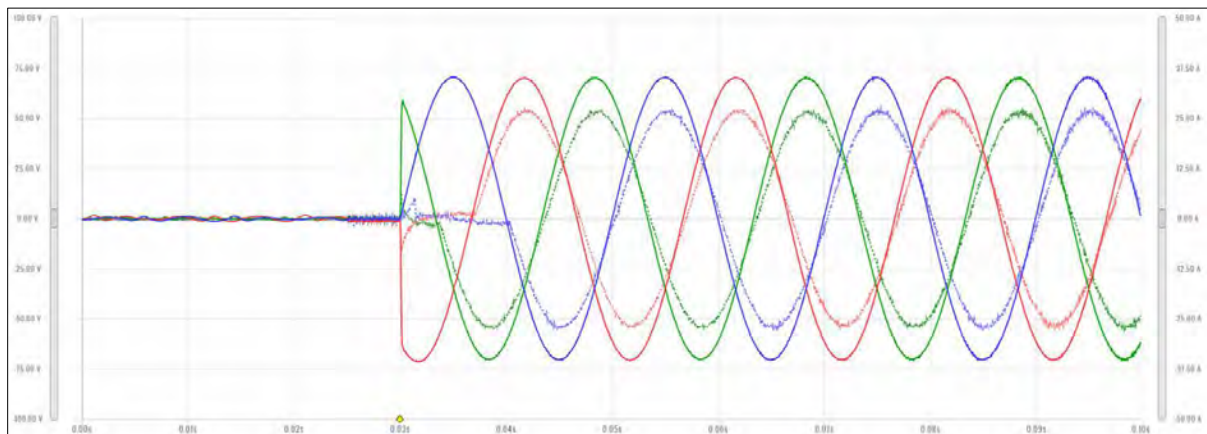

The dynamic of the voltage spikes depends on DUT, capacitance, and programmed current. If the user desires to further mitigate the spikes a pre-charge resistance, additional output

capacitance, and/or active voltage clamping could be used. In those cases, please contact PPS support.

The SCPI commands for this feature are:

Query Syntax	[SOURce:]HIGHIMPEDance[:STATe]#?
Description	Returns the status of the high impedance state mode.
Returned Data Format	0 = OFF , 1 = ON.
Query Example	HIGHIMPED:STAT? 1
Command Syntax	[SOURce:]HIGHIMPEDance:THREshold:MODE# <0 1>
Description	Sets the Threshold mode to either absolute or relative (%) over voltage level mode.
Parameters	0 = Level, 1 = % of OVP
Parameter Format	<nr1>
Example	HIGHIMPED:THRE:MODE1 0
Query Format	[SOURce:]HIGHIMPEDance:THREshold:MODE#?
Returned Data Format	Returns setting
Query Example	HIGHIMPED:THRE:MODE1? 1
Command Syntax	[SOURce:]HIGHIMPEDance:HYSTeresis:LEVel# <LEVEL>
Description	Sets the Hysteresis level used to detect the need to enter or exit high impedance mode.
Parameters	Voltage
Parameter Format	<nr2>
Example	HIGHIMPED:HYST:LEVel2 24.0
Query Format	[SOURce:]HIGHIMPEDance:HYSTeresis:LEVel#?
Returned Data Format	<nr2>
Query Example	HIGHIMPED:HYST:LEV2? 24.000
Command Syntax	[SOURce:]HIGHIMPEDance:THREshold:PERcentage# <PERCENTAGE>
Description	Sets the Hysteresis level used to detect the need to enter or exit high impedance mode as an absolute level.
Parameters	0.00...100.00
Parameter Format	<nr2>
Example	HIGHIMPED:THRE:PER1 33.0
Query Format	[SOURce:]HIGHIMPEDance:THREshold:PERcentage?
Returned Data Format	<nr2>
Query Example	HIGHIMPED:THRE:PER? 33.0

8.10 Status Commands

Status commands control status and event registers. These commands are aliases for some of the IEEE488.2 common commands and may be used interchangeably. Refer to section 8.12, “Status and Events Registers” for details on status and event register configurations.

The following status commands are supported.

Command	Description
STATus:OPERation[:EVENT]?	Queries the Operation Status Event Register
STATus:OPERation:CONDition?	Queries the Operation Status Condition Register
STATus:OPERation:ENABle <nr1>	Sets the Operation Status Enable Register
STATus:OPERation:ENABle?	Queries the Operation Status Enable Register
STATus:QUESTionable[:EVENT]?	Queries the Questionable Status Event Register
STATus:QUESTionable:CONDition?	Queries the Questionable Status Condition Register
STATus:QUESTionable:ENABle <nr1>	Sets the Questionable Status Enable Register
STATus:QUESTionable:ENABle?	Queries the Questionable Status Enable Register
STATus:PRESet	Presets the Status Registers

Query Format	STATus:OPERation[:EVENT]?
Description	Queries the Operation Status Event Register.
Returned Data Format	<nr1>
Query Example	STAT:OPER? 0

Query Format	STATus:OPERation:CONDition?
Description	Queries the Operation Status Condition Register.
Returned Data Format	<nr1>
Query Example	STAT:OPER:COND? 0

Command Syntax	STATus:OPERation:ENABle <nr1>
Description	Sets the content Operation Status Enable Register.
Parameters	0-32767
Parameter Format	<nr1>
Example	STAT:OPER:ENAB 255
Query Format	STATus:OPERation:ENABle?
Returned Data Format	<nr1>
Query Example	STAT:OPER:ENAB? 6144

Query Format	STATus:QUEStionable[:EVENT]?
Description	Queries the Questionable Status Event Register.
Returned Data Format	<nr1>
Query Example	STAT:QUES? 0
Query Format	STATus:QUEStionable:CONDition?
Description	Queries the Questionable Status Condition Register.
Returned Data Format	<nr1>
Query Example	STAT:QUES:COND? 0
Command Syntax	STATus:QUEStionable:ENABle
Description	Sets the content of the Questionable Status Enable Register.
Parameters	0-32767
Parameter Format	<nr1>
Example	STAT:QUES:ENAB 255
Query Format	STATus:QUEStionable:ENABle?
Returned Data Format	<nr1>
Query Example	STAT:QUES:ENAB? 255
Command Syntax	STATus:PRESet
Description	The Status Preset command presets the Status Registers. The Operational Status. Enable Register is set to 0 and the Questionable Status Enable Register is set to 0.
Parameters	None
Parameter Format	n/a
Example	STAT:PRES

8.11 System Commands

Systems commands control system level functions or return model and revision information on the connected unit. The following system commands are supported.

8.11.1 System Error Commands

Query Format **SYSTem:ERRor[:NEXT]?**
Description This command returns next available error message from the error queue. If no more error messages are available, returns 0, "NO ERROR" result. Available error messages are:

Returned Data Format	ERROR	Description
	-0, "No error"	No error detected
	-100, "Command error"	indicates invalid command or query received
	-102, "Command error: Syntax error."	Incorrect command syntax
	-200, "Execution error"	indicates can't execute command with parameters received
	-222, "Command error: Data out of range."	Data exceeds available parameter range
	-300, "Device-specific error"	indicates UPC not properly configured
	-400, "Query error"	indicates query aborted

Query Example SYST:ERR?
-102, "Command error: Syntax error."

Query Format **SYSTem:ERRor:ALL?**
Description Returns all available error messages as a of error numbers and clears the error message queue.

Returned Data Format TOTAL_ERRORS , ERRORS, CODE(INDEX), DESCRIPTION(INDEX), CODE(INDEX+1), DESCRIPTION(INDEX+1),..., CODE(INDEX+N), DESCRIPTION(INDEX+N),...

Query Example SYST:ERR:ALL?
0,0
SYST:ERR:ALL?
2,2,-102, "Command error: Syntax error. Webpage interface.;2022/10/12 18:23:37",-102, "Command error: Syntax error. Webpage interface.+2022/10/12 18:23:50"

Command Syntax **SYSTem:ERRor:ALL:CLEAR**
Description This command clears the error message queue.
Parameters None
Parameter Format n/a
Example SYST:ERR:ALL:CLEAR

Command Syntax	SYSTem:ERROr:ALL:NOCLEAR? < Optional: Index>
Description	Returns all available error messages as a single unterminated string but does not clear the error message queue .
Returned Data Format	<p><nr1>,<nr1>,...<nr1></p> <p>Format of response: YYYY/MM/DD,HH:MM::SS,S.NS,TOTAL_ERRORS,INDEX,ERRORS,CODE (INDEX),DESCRIPTION(INDEX),CODE(INDEX+1),DESCRIPTION(INDEX+1),...,CODE(INDEX+N),DESCRIPTION(INDEX+N),...</p> <p>Response Legend: YYYY/MM/DD,HH:MM::SS,S.NS is the timestamp of the latest error pushed to the queue. S is absolute seconds and NS absolute nanoseconds. TOTAL_ERRORS are the total errors in the queue. INDEX is 1 by default if not passed as optional argument. ERRORS is the total errors returned in the response. As there may be too many errors the response may return a few of them starting from the INDEX. The INDEX is useful to navigate the queue. CODE is the error code and DESCRIPTION the description.</p>
Query Example	<pre>SYST:ERR:ALL:NOCLEAR? 2018/05/29,14:29:53,1207438.903668873,0,1,0</pre> <p><u>For no errors:</u></p> <pre>>SYSTem:ERROr:ALL:NOCLEAR? 2022/10/12,18:17:01,122450.794695832,0,1,0</pre> <p><u>Two errors in the queue:</u></p> <pre>>SYSTem:ERROr:ALL:NOCLEAR? 2022/10/12,18:17:19,122467.903705666,2,1,2,-102,"Command error: Syntax error. Webpage interface.;"2022/10/12 18:17:18",-102,"Command error: Syntax error. Webpage interface.;"2022/10/12 18:17:19" >SYSTem:ERROr:ALL:NOCLEAR? 2 2022/10/12,18:17:19,122467.903705666,2,2,1,-102,"Command error: Syntax error. Webpage interface.;"2022/10/12 18:17:19"</pre>

Command Syntax	SYSTem:ERRor:POE
Description	This command sets the Power on Error reporting mode. Returns status of Power on Error setting as 1 (enabled) or 0 (disabled).
Parameters	< 0 OFF 1 ON >
Parameter Format	
Example	SYST:ERR:POE ON
Query Format	SYSTem:ERRor:POE?
Returned Data Format	
Query Example	SYST:ERR:POE? 1

8.11.2 System Information Commands

Command Syntax	SYSTem:BEEP
Description	This command generates an audible beep at the front panel of the power source.
Parameters	None
Parameter Format	n/a
Example	SYST:BEEP

Query Format	SYSTem:FW:FRONTPANEL:VERsion?
Description	Returns the firmware revision for the front panel processor.
Returned Data Format	<cr>
Query Example	SYST:FW:FRONTPANEL:VER? 2.0.0

Query Format	SYSTem:FW:FRONTPANEL:APPS:VERsion?
Description	Returns the firmware revision for the front panel application program.
Returned Data Format	<cr>
Query Example	SYST:FW:FRONTPANEL:APPS:VER? 2.0.0

Query Format	SYSTem:FW:IO:VERsion?
Description	Returns the firmware revision for the Auxiliary I/O board processor on AZX-xA version power sources.
Returned Data Format	<cr>
Query Example	SYST:FW:IO? 1.0.4

Query Format	SYSTem:FW:POWER:VERsion?
Description	Returns the revision number of the power source's power stages.
Returned Data Format	<nr2>-<nr2>
Query Example	SYST:FW:POWER:VER? 81.0.0-77.1.0

Query Format	SYSTem:LANGuage:CATalog?
Description	Returns list of available languages that can be selected for front panel operation.
Returned Data Format	<cr>
Query Example	SYST:LANG? english, chinese
Query Format	SYSTem:LXI:FEATures?
Description	R eturns string listing supported LXI features.
Returned Data Format	<cr>
Query Example	SYST:LXI:FEAT? None
Query Format	SYSTem:LXI:VERSion?
Description	Returns LXI revision compliance version number.
Returned Data Format	<cr>
Query Example	SYST:LXI:VERSION? LXI Core 2011
Query Format	SYSTem:MODE?
Description	Returns LOCAL (0) or REMOTE (1) front panel status. Use IEEE 488.2 command commands *LLO to lock front panel and *GTL to release front panel operation.
Returned Data Format	
Query Example	SYST:MODE? 1
Query Format	SYSTem:SERIALNUM?
Description	Returns the serial number of the power source. Same information can be queried with the *IDN? command
Returned Data Format	<nr1>
Query Example	SYST:HWREV? 0
Command Syntax	SYSTem:TIME
Description	Set the date and time.
Parameters	YYYY-MM-DD HH:MM:SS
Example	SYST:TIME 2022-05-21 16:21:02
Query Format	SYSTem:TIME?
Description	Returns real time clock date and time. Note: Since both date and time are returned, there is no SYSTem:DATE?
Returned Data Format	DD/MM/YYYY HH:MM:SS
Query Example	SYSTem:TIME? 29/05/2019 14:40:57

<p>Query Format Description Returned Data Format Query Example</p>	<p>SYSTem:TIME:SOURce? Queries source of date and time information. <cr> SYST:TIME:SOUR? NTP Note: NTP stands for “Network Time Protocol”. A protocol built on top of TCP/IP that assures accurate local timekeeping with reference to radio, atomic or other clocks located on the Internet. This protocol is capable of synchronizing distributed clocks within milliseconds over long time periods. It is defined in STD 12, RFC 1119 (RFC = Request for comment. RFCs are used by the Internet Engineering Task Force (IETF) and other standards bodies.</p>
<p>Query Format Description Returned Data Format Query Example</p>	<p>SYSTem:TIME:UTC? Returns the UTC time, independent of the zone. DD/MM/YYYY HH:MM:SS SYST:TIME:UTC? 29/05/2019 14:40:57</p>
<p>Command Syntax Description Example Query Format Description Returned Data Format Query Example</p>	<p>SYSTem:TIME:ZONE <ZONE> Set the zone, allowed values are GMT+/-X. SYST:TIME:ZONE GMT-7 SYSTem:TIME:ZONE? Returns the current time zone setting, normally GMT+/-X <cr> SYST:TIME:ZONE? GMT-7</p>
<p>Query Format Description Returned Data</p>	<p>SYSTem:TIME:ZONE:CATalog? Returns the available zones. GMT-12,GMT-11,GMT-10,GMT-9,GMT-8,GMT-7,GMT-6,GMT-5,GMT-4, GMT-3, GMT-2,GMT-1,GMT+0,GMT+1,GMT+2,GMT+3,GMT+4,GMT+5, GMT+6,GMT+7,GMT+8,GMT+9,GMT+10,GMT+11,GMT+12,GMT+13, GMT+14</p>
<p>Command Syntax Description Parameters Example Query Format Description Returned Data</p>	<p>SYSTem:TIME:ZONE:LEAP <0 OFF 1 ON> Enables or Disables Leap Second mode. 1 or ON to consider leap seconds, otherwise 0 or OFF SYST:TIME:LEAP ON SYSTem:TIME:ZONE:LEAP? Returns 1 if it considers leap seconds, otherwise 0. 1 = Leap seconds considered, 0 = Leap seconds ignored</p>

<p>Command Syntax Description</p>	<p>SYSTem:TIME:SOURce < RTC NTP > Set the time source, RTC is the local real time clock of the front panel. NTP is internet time protocol. NTP requires internet connection. If NTP is used with internet connection then the RTC is updated every time the NTP synchronizes.</p>
<p>Parameters Example</p>	<p>< RTC NTP > SYST:TIME:SOUR NTP</p>
<p>Query Format Description Returned Data</p>	<p>SYSTem:TIME:SOURce:CATalog? Returns the available time source options, NTP or RTC. NTP, RTC</p>
<p>Query Format Description Returned Data</p>	<p>SYSTem:TIME:SOURce:NTP:SERVer? Returns “pool.ntp.org” This is the server that uses the unit NTP service. pool.ntp.org</p>
<p>Command Syntax Description Parameters Example</p>	<p>SYSTem:TIME:SOURce:NTP:SYNC <OPTIONAL: SERVER> Forces an NTP sync. If the argument is not passed then it uses “pool.ntp.org”. Any IP/domain that runs a NTP server can be used. Alternative commons servers are “time.windows.com” or “time.nist.gov”. < time server domain > SYST:TIME:SOUR:NTP:SYNC</p>
<p>Command Syntax Description Parameters Example</p>	<p>SYSTem:TIME:SOURce:NTP:REStart Restarts the NTP service none SYST:TIME:SOUR:NTP:REST</p>
<p>Query Format Description Returned Data Format Query Example</p>	<p>SYSTem:VERSion? Returns SCPI standard revision version. <nr2> SYST:VERS? 1992.0</p>
<p>Query Format Description Returned Data Format Query Example</p>	<p>SYSTem:XFMRRATIO? Returns the transformer option (T Option) voltage ratio. If no transformer option is installed and configured, this query will return a value of 0.000. See also the [SOURce:]COUPLing command. <nr2> SYSTem:XFMRRATIO? 1.3333</p>

8.11.3 System Interface Commands

These commands allow programming of the output programming preset soft key values for the front panel user interface of the power source. The same can be accomplished by the user from the front panel. Using a program to set these value can ensure they are always set to a known value if this is important for operator use of the power source in a specific test situation.

8.11.3.1 Preset Syntax

The syntax for all these commands is very similar. Prefix is always "SYSTem:INTERFace:PRESET:" followed by the parameter. Available soft key preset parameters are:

- VOLTage[:AC]
- VOLTage:DC
- FREQuency
- PHASe
- CURRent:LIMit
- POWER:LIMit
- KVA:LIMit

To program or query a specific soft key number (1 ~ 5), append "SK#" to the command where # is a value from 1 through 5 for soft key 1 through 5. (Top soft key = 1, bottom soft key = 5).

8.11.3.2 Command parameters

Available softkey parameters are:

- MIN MIN is the preset value for the min allowable setting based on the power source model
- MAX MAX is the the preset value for the max allowable setting based on the power source model
- DEF DEF sets the preset value to factory default
- Value A <nr1> value between MIN and MAX may be specified instead.

Up to five sets of parameters can be appended to these commands to program more than one soft key for the same parameter setting with a single command string.

Example:

```
SYST:INTERF:PRESET:VOLT MAX, MIN, 108, 140
```

Programs the voltage AC soft keys as follows:

```
SK1 = MAX or 300, SK2 = MIN or 0, SK3 = 108, SK4 = 140.
```

8.11.3.3 Preset Commands Listing

The following lists shows all available soft key preset programming commands.

Voltage AC

SYSTem:INTERFace:PRESET:VOLTage[:AC] <REQ: MIN|MAX|DEF|Value, OPT: MIN|MAX|DEF|Value, OPT: MIN|MAX|DEF|Value, OPT: MIN|MAX|DEF|Value, OPT: MIN|MAX|DEF|Value>

SYSTem:INTERFace:PRESET:VOLTage[:AC]? <OPT: ALL|DEF> <OPT: ALL|DEF>

SYSTem:INTERFace:PRESET:VOLTage[:AC]:SK# <REQ: MIN|MAX|DEF|Value>

SYSTem:INTERFace:PRESET:VOLTage[:AC]:SK#?

Voltage DC

SYSTem:INTERFace:PRESET:VOLTage:DC <REQ: MIN|MAX|DEF|Value, OPT: MIN|MAX|DEF|Value, OPT: MIN|MAX|DEF|Value, OPT: MIN|MAX|DEF|Value, OPT: MIN|MAX|DEF|Value>

SYSTem:INTERFace:PRESET:VOLTage:DC? <OPT: ALL|DEF> <OPT: ALL|DEF>

SYSTem:INTERFace:PRESET:VOLTage:DC:SK# <REQ: MIN|MAX|DEF|Value>

SYSTem:INTERFace:PRESET:VOLTage:DC:SK#?

Frequency

SYSTem:INTERFace:PRESET:FREQuency <REQ: MIN|MAX|DEF|Value, OPT: MIN|MAX|DEF|Value, OPT: MIN|MAX|DEF|Value, OPT: MIN|MAX|DEF|Value, OPT: MIN|MAX|DEF|Value>

SYSTem:INTERFace:PRESET:FREQuency? <OPT: ALL|DEF> <OPT: ALL|DEF>

SYSTem:INTERFace:PRESET:FREQuency:SK# <REQ: MIN|MAX|DEF|Value>

SYSTem:INTERFace:PRESET:FREQuency:SK#?

Phase Angle

SYSTem:INTERFace:PRESET:PHASe <REQ: MIN|MAX|DEF|Value, OPT: MIN|MAX|DEF|Value, OPT: MIN|MAX|DEF|Value, OPT: MIN|MAX|DEF|Value, OPT: MIN|MAX|DEF|Value>

SYSTem:INTERFace:PRESET:PHASe? <OPT: ALL|DEF> <OPT: ALL|DEF>

SYSTem:INTERFace:PRESET:PHASe:SK# <REQ: MIN|MAX|DEF|Value>

SYSTem:INTERFace:PRESET:PHASe:SK#?

Current Limit

SYSTem:INTERFace:PRESET:CURRent:LIMit <REQ: MIN|MAX|DEF|Value, OPT: MIN|MAX|DEF|Value, OPT: MIN|MAX|DEF|Value, OPT: MIN|MAX|DEF|Value, OPT: MIN|MAX|DEF|Value>

SYSTem:INTERFace:PRESET:CURRent:LIMit? <OPT: ALL|DEF> <OPT: ALL|DEF>

SYSTem:INTERFace:PRESET:CURRent:LIMit:SK# <REQ: MIN|MAX|DEF|Value>

SYSTem:INTERFace:PRESET:CURRent:LIMit:SK#?

Power Limit

SYSTem:INTERFace:PRESET:POWer:LIMit <REQ: MIN|MAX|DEF|Value, OPT: MIN|MAX|DEF|Value, OPT: MIN|MAX|DEF|Value, OPT: MIN|MAX|DEF|Value, OPT: MIN|MAX|DEF|Value>

SYSTem:INTERFace:PRESET:POWer:LIMit? <OPT: ALL|DEF> <OPT: ALL|DEF>

SYSTem:INTERFace:PRESET:POWer:LIMit:SK# <REQ: MIN|MAX|DEF|Value>

SYSTem:INTERFace:PRESET:POWER:LIMit:SK#?

Apparent Power Limit

SYSTem:INTERFace:PRESET:KVA:LIMit <REQ: MIN|MAX|DEF|Value, OPT: MIN|MAX|DEF|Value, OPT: MIN|MAX|DEF|Value, OPT: MIN|MAX|DEF|Value, OPT: MIN|MAX|DEF|Value>

SYSTem:INTERFace:PRESET:KVA:LIMit? <OPT: ALL|DEF> <OPT: ALL|DEF>

SYSTem:INTERFace:PRESET:KVA:LIMit:SK# <REQ: MIN|MAX|DEF|Value>

SYSTem:INTERFace:PRESET:KVA:LIMit:SK#?

Examples of programming User Preset Soft keys:

SYST:INTERF:PRESET:VOLT:AC 115.000,230.000,300.000,MAX

SYST:INTERF:PRESET:VOLT:DC MAX,200.000,0.000,-200.000,MIN

SYST:INTERF:PRESET:FREQ 50.000,60.000,400.000,800.000,1000.000

SYST:INTERF:PRESET:PHAS 0.000,90.000,120.000,180.000,240.000

SYST:INTERF:PRESET:CURR:LIM MAX,15.000,5.000

SYST:INTERF:PRESET:POW:LIM MAX,4.000,2.000,1.000

SYST:INTERF:PRESET:KVA:LIM MAX,4.000,2.000,1.000

Examples of programming a specific User Preset Soft key:

SYST:INTERF:PRESET:VOLT:AC:SK1 115

Examples of querying programming User Preset Soft key settings:

SYSTem:INTERF:PRESET:VOLT:AC? -> 115.000,230.000,300.000,MAX

SYSTem:INTERF:PRESET:VOLT:DC? -> MAX,200.000,0.000,-200.000,MIN

SYSTem:INTERF:PRESET:FREQ? -> 50.000,60.000,400.000,800.000,1000.000

SYSTem:INTERF:PRESET:PHAS? -> 0.000,90.000,120.000,180.000,240.000

SYSTem:INTERF:PRESET:CURR:LIM? -> MAX,15.000,5.000

SYSTem:INTERF:PRESET:POW:LIM? -> MAX,4.000,2.000,1.000

SYSTem:INTERF:PRESET:KVA:LIM? -> MAX,4.000,2.000,1.000

Example of querying programming User Preset for a specific soft key number:

SYST:INTERF:PRESET:VOLT:AC:SK1? -> 115.000

8.11.3.4 Other Front Panel Function Commands

These commands are equivalent to some of the functions available in the LOCAL INTERFACE settings.

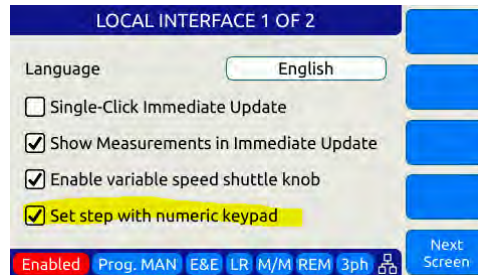

Beeper Volume - Range is 0 through 10:

SYSTem:INTERFace:VOLUme <VOLUME>

SYSTem:INTERFace:VOLUme?

LCD Brightness - Range is 0 through 10:

SYSTem:INTERFace:LCD[:BRIGHTness] <BRIGHTNESS>

SYSTem:INTERFace:LCD[:BRIGHTness]?

Keypad Backlit Brightness - Range is 0 through 10:

SYSTem:INTERFace:KEYS:BRIGHTness <BRIGHTNESS>

SYSTem:INTERFace:KEYS:BRIGHTness?

Key Press Sounds:

SYSTem:INTERFace:KEYS:SOUNDS <ON|OFF>

SYSTem:INTERFace:KEYS:SOUNDS?

Set Resolution Step Size with the numeric keypad

SYSTem:INTERFace:KEYS:STEPset <ON|OFF>

SYSTem:INTERFace:KEYS:STEPset?

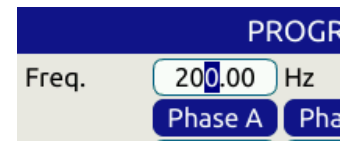

Single Click Update Mode:

SYSTem:INTERFace:IMMEDIATEupdate:SINGLEclick <ON|OFF>

SYSTem:INTERFace:IMMEDIATEupdate:SINGLEclick?

Show Measurements in Immediate Update:

SYSTem:INTERFace:IMMEDIATEupdate:SHOWMEASurements <ON|OFF>

SYSTem:INTERFace:IMMEDIATEupdate:SHOWMEASurements?

Variable Shuttle Knob Speed - Range is 0 through 10:

SYSTem:INTERFace:KNOB:SPeed <SPEED>

SYSTem:INTERFace:KNOB:SPeed?

8.11.4 System Configuration Commands

Query Format	SYSTem:FEATures?
Description	Returns the available features and functions that are configured on the unit. Note that some features may require options and may not be present on your unit.
Returned Data Format	<cr>
Query Example	SYST:FEAT? Trigger output,Trigger input,Strobe source,Strobe output,I/O Board,GPIB,Enhanced controller,Single phase,Split phase,Three phase,Programmable phase,Transient,Harmonic analysis and waveform scope,Programmable impedance,Arbitrary waveforms,Extended frequency,True line to line measurement,Watt-hour meter,Peak current register,AC voltage
Query Format	SYSTem:MAXKVA?
Description	Returns maximum available kVA output capability of the power source.
Returned Data Format	<nr2>
Query Example	SYST:MAXKVA? 50.000
Query Format	SYSTem:MAXCURRent?
Description	Returns maximum available RMS or DC output current capability of the power source.
Returned Data Format	<nr2>
Query Example	SYST:MAXCURR? 130.0000
Query Format	SYSTem:MAXVOLTage?
Description	Returns maximum available RMS or DC voltage output capability of the power source.
Returned Data Format	<nr1>
Query Example	SYST:MAXVOLT? 360
Command Syntax	SYSTem:COMPAtible
Description	Sets Pacific Power Source UPC controller compatibility mode. This mode allows use of the power source with legacy software. Not available on AZX Series.
Parameters	< 0 DISABLE 1 UPC >
Parameter Format	
Example	SYST:COMP UPC
Query Format	SYSTem:COMPAtible?
Returned Data Format	
Query Example	SYST:COMP? 1

Query Format	SYSTem:HWREVision?
Description	Returns the hardware revision letter of the power source
Returned Data Format	<cr>
Query Example	SYST:HWREV? A
Command Syntax	SYSTem:LANGuage
Description	Sets Pacific Power Source UPC controller compatibility mode. This mode allows use of the power source with legacy software.
Parameters	< english Chinese > Note: Refer to SYSTem:LANGuage:CATalog? query command for list of supported languages.
Parameter Format	<cr>
Example	SYST:LANG chinese
Query Format	SYSTem:LANGuage?
Returned Data Format	
Query Example	SYST:LANG? chinese

8.11.5 System Operation Mode Commands

These commands selects between the available operation mode of the Power System. Note that some commands may be options and not supported on the model configuration used.

Available modes are:

- Voltage Source
- Current Source
- Active Load (Requires option L)

Command Syntax	SYSTem:OPMMode [0 1 2]
Description	Sets the operating mode of the unit
Parameters	0 Voltage Source 1 Current Source 2 Active Load
Parameter Format	<nr1>
Example	SYST:OPMO 0
Query Format	SYSTem:OPMMode?
Returned Data Format	<nr1>
Query Example	SYST:OPMO? 2
Query Format	SYSTem:OPMMode:CATalog?
Description	Returns the available operation mode settings.
Returned Data Format	<nr1>,<cr>,<nr1>,<cr>,<nr1>,<cr>
Return Value	0, Voltage Source, 1, Current Source, 2, Active Load
Query Example	SYST:OPMO:CAT? 0, Voltage Source, 1, Current Source, 2, Active Load

8.11.6 Parallel System Commands

Command Syntax	SYSTem:DISCOVERY
Description	Initiates discovery of the number of paralleled power sources
Parameters	None
Parameter Format	n/a
Example	SYST:DISCOVERY
Query Format	SYSTem:PARALLELUNITS?
Description	Returns the number of power sources found.
Returned Data Format	<nr1>
Query Example	SYST:PARALLELUNITS? 1
Command Syntax	SYSTem:PARALLELUNITS:EXPEcted
Description	Sets the number of power sources that should be connected to the system interface bus.
Parameters	1 – 200
Parameter Format	<nr1>
Example	SYST:PARALLELUNITS:EXPE 4
Query Format	SYSTem:PARALLELUNITS:EXPEcted?
Returned Data Format	<nr1>
Query Example	SYST:PARALLELUNITS:EXPE? 4

8.11.7 System Sanitization Commands

Query Format	SYSTem:SANITIZE:CODE?
Description	Returns sanitization password string.
Returned Data Format	<nr1>
Query Example	SYSTem:SANITIZE:CODE? 0659
Command Syntax	SYSTem:SANITIZE <code>
Description	Erases all user data stored in non-volatile memory settings including settings and custom waveforms if required. The code is obtained by the query command above.
Parameters	None
Parameter Format	n/a
Example	SYST:SANITIZE 0659

8.11.8 Communication LAN Commands

Command Syntax	SYSTem:COMMunicate:LAN[:ENABLE]
Description	This command turns remote control via LAN on or off. To control the power source through its LAN interface, this state has to on (1).
Parameters	< 0 OFF 1 ON >
Parameter Format	
Example	SYST:COMM:LAN ON
Query Format	SYSTem:COMMunicate:LAN[:ENABLE]?
Returned Data Format	
Query Example	SYST:COMM:LAN? 1
Command Syntax	SYSTem:COMMunicate:LAN:RESPonse
Description	This command allows the termination character for LAN communication to be defined by the user.
Parameters	0 (AUTO) 1 (\r\n) 2 (\n) 3 (\r)
Parameter Format	<nr1>
Example	SYST:COMM:LAN:REPSONSE 1
Query Format	SYSTem:COMMunicate:LAN:RESPonse?
Returned Data Format	<nr1>
Query Example	SYST:COMM:LAN:RESP? 1

Command Syntax	SYSTem:COMMunicate:LAN:RESPonse:TELNET
Description	This command allows the termination character for LAN Telnet communication to be defined by the user.
Parameters	0 (AUTO) 1 (\r\n) 2 (\n) 3 (\r)
Parameter Format	<nr1>
Example	SYST:COMM:LAN:REPSONSE:TELNET 1
Query Format	SYSTem:COMMunicate:LAN:RESPonse:TELNET?
Returned Data Format	<nr1>
Query Example	SYST:COMM:LAN:RESP:TELNET? 1

Command Syntax	SYSTem:COMMunicate:SERial:RESPonse
Description	This command allows the termination character for RS232 communication to be defined by the user.
Parameters	0 (AUTO) 1 (\r\n) 2 (\n) 3 (\r)
Parameter Format	<nr1>
Example	SYST:COMM:SERial:RESPonse 1
Query Format	SYSTem:COMMunicate:SERial:RESPonse?
Returned Data Format	<nr1>
Query Example	SYST:COMM:SER:RESP? 1

Command Syntax	SYSTem:COMMunicate:USB:VIRTualport:RESPonse
Description	This command allows the termination character for USB communication to be defined by the user.
Parameters	0 (AUTO) 1 (\r\n) 2 (\n) 3 (\r)
Parameter Format	<nr1>
Example	SYST:COMM:USB:VIRT:RESPonse 1
Query Format	SYSTem:COMMunicate:USB:VIRTualport:RESPonse?
Returned Data Format	<nr1>
Query Example	SYST:COMM:USB:VIRT:RESP? 1

Command Syntax	SYSTem:COMMunicate:LXI:RESPonse
Description	This command allows the termination character for USB communication to be defined by the user.
Parameters	0 (AUTO) 1 (\r\n) 2 (\n) 3 (\r)
Parameter Format	<nr1>
Example	SYST:COMM:LXI:RESPonse 1
Query Format	SYSTem:COMMunicate:LXI:RESPonse?
Returned Data Format	<nr1>
Query Example	SYST:COMM:LXI:RESP? 1

<p>Query Format Description</p> <p>Returned Data Format Query Example</p>	<p>SYSTem:COMMunicate:LAN:STATus?</p> <p>This command returns all LAN settings in a single comma delimited string of values.</p> <p><cr>, <cr>,.....,<cr>,<cr></p> <p>SYSTem:COMMunicate:LAN:STATus? 192.168.14.22,255.255.254.0,192.168.15.254,192.168.15.208,AZX-106378937,AZX-106378889,0,1,0</p>
<p>Command Syntax Description</p> <p>Parameters Parameter Format Example Query Format Returned Data Format Query Example</p>	<p>SYSTem:COMMunicate:LAN:DHCP[:ENABLE]</p> <p>This command turns DHCP mode for the LAN interface on or off. DHCP = Dynamic Host Configuration Protocol". This protocol automatically provides an IP address and other related information such as the subnet mask and default gateway. When turned off, a static IP address must be assigned by the user instead.</p> <p>< 0 OFF 1 ON ></p> <p></p> <p>SYST:COMM:LAN:DHCP ON</p> <p>SYSTem:COMMunicate:LAN:DHCP[:ENABLE]?</p> <p></p> <p>SYST:COMM:LAN:DHCP? 1</p>
<p>Command Syntax Description</p> <p>Parameters Parameter Format Example</p>	<p>SYSTem:COMMunicate:LAN:DHCP:RENEW</p> <p>This command renews the lease of an IP address assigned through the DHCP protocol. This may be necessary if the power source has not been used in a while and its IP address lease has expired. If not renewed, a different IP address may be assigned.</p> <p>None</p> <p>n/a</p> <p>SYST:COMM:LAN:DHCP:RENEW</p>
<p>Command Syntax Description</p> <p>Parameters Parameter Format Example Query Format Returned Data Format Query Example</p>	<p>SYSTem:COMMunicate:LAN:ADDRESS</p> <p>This command is used to assign a fixed IP address to the power source for LAN communication.</p> <p>ddd.ddd.ddd.ddd (four octets ranging in value from 0 to 255 representing one 16 bit unsigned integer value each.</p> <p><cr></p> <p>SYST:COMM:LAN:ADD 132.18.21.105</p> <p>SYSTem:COMMunicate:LAN:ADDRESS?</p> <p><cr></p> <p>SYST:COMM:LAN:ADD? 132.18.21.105</p>

<p>Query Format Description</p>	<p>SYSTem:COMMunicate:LAN:MACaddress? This query returns the MAC address of the connected power source. The Media Access Control address or MAC address is also referred to as physical address as it is fix and unique to any device on the network. The MAC address for the power source is also printed on the rear panel near the LAN interface connector. It consists of 8 sets of hexadecimal 16 bit unsigned integer values.</p>
<p>Returned Data Format Query Example</p>	<p><cr> SYST:COMM:LAN:MAC? 3A.3F.00.4C.DE.AA.39.8F</p>
<p>Query Format Description Returned Data Format Query Example</p>	<p>SYSTem:COMMunicate:LAN:VISA? Queries the VISA resource name / address string <cr> TCPIP::AZX-1003::INSTR</p>
<p>Command Syntax Description Parameters Parameter Format Example</p>	<p>SYSTem:COMMunicate:LAN:APPLY Applies all changes send using the COMM:LAN commands. None n/a SYST:COMM:LAN:APP</p>
<p>Command Syntax Description Parameters Parameter Format Example Query Format Returned Data Format Query Example</p>	<p>SYSTem:COMMunicate:LAN:MASK This command sets the IP mark value for the power source LAN interface. It is normally obtained through DHCP. If a static IP must be used, the mask has to set as well. ddd.ddd.ddd.ddd (four octets ranging in value from 0 to 255 representing one 16 bit unsigned integer value each. <cr> SYST:COMM:LAN:MASK 255.255.254.0 SYSTem:COMMunicate:LAN:MASK? <cr> SYST:COMM:LAN:MASK? 255.255.254.0</p>
<p>Command Syntax Description Parameters Parameter Format Example Query Format Returned Data Format Query Example</p>	<p>SYSTem:COMMunicate:LAN:DNSaddress Sets the IP address for the DNS server ddd.ddd.ddd.ddd (four octets ranging in value from 0 to 255 representing one 16 bit unsigned integer value each. <cr> SYST:COMM:LAN:DNS 132.18.21.208 SYSTem:COMMunicate:LAN:DNSaddress? <cr> SYST:COMM:LAN:DNS? 132.18.21.208</p>

<p>Command Syntax Parameters</p>	<p>SYSTem:COMMunicate:LAN:GWADdress Sets the IP address for the Network Gateway. A default gateway is the node on the computer network that the network software uses when an IP address does not match any other routes in the routing table</p>
<p>Parameter Format Example Query Format Returned Data Format Query Example</p>	<p><cr> SYST:COMM:LAN:GWAD 132.18.21.254 SYSTem:COMMunicate:LAN:GWADdress? <cr> SYST:COMM:LAN:GWAD? 132.18.21.254</p>
<p>Command Syntax Description</p>	<p>SYSTem:COMMunicate:LAN:HOST:CONFigured Sets the network host address. The host address is the portion of the address used to identify hosts (any device requiring a Network Interface Card, such as a PC or networked printer) on the network. The network ID, by contrast, is the portion of the address that refers to the network itself.</p>
<p>Parameters</p>	<p>ddd.ddd.ddd.ddd (four octets ranging in value from 0 to 255 representing one 16 bit unsigned integer value each.</p>
<p>Parameter Format Example Query Format Returned Data Format Query Example</p>	<p><cr> SYST:COMM:LAN:HOST 132.18.21.0 SYSTem:COMMunicate:LAN:HOST:CONFigured? <cr> SYST:COMM:LAN:HOST:CONF? 132.18.21.0</p>
<p>Command Syntax Description</p>	<p>SYSTem:COMMunicate:LAN:PASSword Assign a password to enable or disable LAN communications. This feature allows the owner/operator to disable or enable remote LAN access or limit functionality over LAN. Note: There is no query format for this command so the password code cannot be queried back.</p>
<p>Parameters Parameter Format Example</p>	<p>Four digit passcode <nr1? SYST:COMM:LAN:PASS 1234</p>
<p>Command Syntax Description</p>	<p>SYSTem:COMMunicate:LAN:PORT Sets LAN interface port address. For SCPI message communications, the standard port number is 5025.</p>
<p>Parameters Parameter Format Example Query Format Returned Data Format Query Example</p>	<p>1024–49151, default = 5025 <nr1> SYST:COMM:LAN:PORT 5025 SYSTem:COMMunicate:LAN:PORT? <nr1> SYST:COMM:LAN:PORT? 5025</p>

Command Syntax	SYSTem:COMMunicate:LAN:PORT:TELNET
Description	Sets the port address for TELNET protocol
Parameters	1024–49151, default = 5024
Parameter Format	<nr1>
Example	SYST:COMM:LAN:PORT:TELNET 5024
Query Format	SYSTem:COMMunicate:LAN:PORT:TELNET?
Returned Data Format	<nr1>
Query Example	SYST:COMM:LAN:PORT:TELNET? 5024
Command Syntax	SYSTem:COMMunicate:LAN:REStart
Description	Restarts the LAN interface. Use after interface faults to reinitialize.
Parameters	None
Parameter Format	n/a
Example	SYST:COMM:LAN:REST
Command Syntax	SYSTem:COMMunicate:LAN:REStart:TELNET
Description	Restarts the LAN TELNET interface. Use after interface faults to reinitialize.
Parameters	None
Parameter Format	n/a
Example	SYST:COMM:LAN:REST:TELNET
Command Syntax	SYSTem:COMMunicate:LAN:REStart:WEB
Description	Restarts the Web interface. Use after interface faults to reinitialize.
Parameters	None
Parameter Format	n/a
Example	SYST:COMM:LAN:REST:WEB

8.11.9 Communication Serial Port Commands

Command Syntax	SYSTem:COMMunicate:SERial[:ENABLE]
Description	This command is used to turn the RS232 serial interface on or off. To use this interface for remote control of the power source, it must be set to ON.
Parameters	< 0 OFF 1 ON >
Parameter Format	
Example	SYST:COMM:SER ON
Query Format	SYSTem:COMMunicate:SERial[:ENABLE]?
Returned Data Format	
Query Example	SYST:COMM:SER? 1

<p>Query Format Description Returned Data Format Query Example</p>	<p>SYSTem:COMMunicate:SERial:STATus? This command returns all serial port settings Baud rate, status,data bits, stop bits, parity, flow control SYST:COMM:SER:STAT? 921600,0,8,1,0,0</p>
<p>Command Syntax Description Parameters Parameter Format Example Query Format Returned Data Format Query Example</p>	<p>SYSTem:COMMunicate:SERial:BAUD This command sets the baud rate for the serial port. < 1200 1800 2400 4800 9600 14400 19200 38400 57600 62500 115200 230400 460800 500000 576000 921600 > <nr1> SYST:COMM:SER:BAUD 115200 SYSTem:COMMunicate:SERial:BAUD? <cr1> SYST:COMM:SER:BAUD? 115200</p>
<p>Command Syntax Description Parameters Parameter Format Example Query Format Returned Data Format Query Example</p>	<p>SYSTem:COMMunicate:SERial:PARity This command sets the parity for the serial port. < 0 NONE 1 OFF 2 EVEN > <nr1> SYST:COMM:SERial:PAR NONE SYSTem:COMMunicate:SERial:PARity? <nr1> SYST:COMM:SER:PAR? 0</p>
<p>Command Syntax Description Parameters Parameter Format Example Query Format Returned Data Format Query Example</p>	<p>SYSTem:COMMunicate:SERial:BITS This command sets the number of data bits used for serial communications. Available settings are 7 or 8 < 7 8 > <nr1> SYST:COMM:SER:BITS 8 SYSTem:COMMunicate:SERial:BITS? <nr1> SYST:COMM:SER:BITS? 8</p>

<p>Command Syntax Description</p> <p>Parameters Parameter Format Example Query Format Returned Data Format Query Example</p>	<p>SYSTem:COMMunicate:SERial:SBITs</p> <p>This command sets the number of stop bits used for serial communications. Available settings are 1 or 2.</p> <p>< 1 2 ></p> <p><nr1></p> <p>SYST:COMM:SER:SBIT 2</p> <p>SYSTem:COMMunicate:SERial:SBITs?</p> <p><nr1></p> <p>SYST:COMM:SER:SBIT?</p> <p>2</p>
<p>Command Syntax Description</p> <p>Parameters Parameter Format Example Query Format Returned Data Format Query Example</p>	<p>SYSTem:COMMunicate:SERial:FLOWcontrol</p> <p>This command sets the method of handshaking used for serial communications. Available settings are Xon/Xoff or Hardware handshake.</p> <p>< 0 OFF 1 ON ></p> <p></p> <p>SYST:COMM:SER:FLOW ON</p> <p>SYSTem:COMMunicate:SERial:FLOWcontrol?</p> <p><nr1></p> <p>SYST:COMM:SER:FLOW?</p> <p>1</p>
<p>Command Syntax Description Parameters Parameter Format Example</p>	<p>SYSTem:COMMunicate:SERial:REStart</p> <p>Restarts the RS232 interface. Use after interface faults to reinitialize.</p> <p>None</p> <p>n/a</p> <p>SYST:COMM:SER:REST</p>

8.11.10 Communication USB Commands

<p>Command Syntax Description Parameters Parameter Format Example Query Format Returned Data Format Query Example</p>	<p>SYSTem:COMMunicate:USB:VIRTualport[:ENABle]</p> <p>This command enables USB device control using virtual comm driver.</p> <p>< 0 OFF 1 ON ></p> <p></p> <p>SYST:COMM:USB:VIRT ON</p> <p>SYSTem:COMMunicate:USB:VIRTualport[:ENABle]?</p> <p></p> <p>SYST:COMM:USB:VIRT?</p> <p>1</p>
---	---

<p>Command Syntax Description</p> <p>Parameters Parameter Format Example Query Format Returned Data Format Query Example</p>	<p>SYSTem:COMMunicate:USB:LAN[:ENABLE] Enables access to embedded webserver using virtual IP Address through USB interface.</p> <p>< 0 OFF 1 ON > SYST:COMM:USB:ETH ON SYSTem:COMMunicate:USB:LAN[:ENABLE]? SYST:COMM:USB:LAN? 1</p>
<p>Command Syntax Description</p> <p>Parameters Parameter Format Example Query Format Returned Data Format Query Example</p>	<p>SYSTem:COMMunicate:USB:LAN:ADDRESS Sets the embedded webserver virtual IP Address for USB interface.</p> <p>< 0 OFF 1 ON > SYST:COMM:USB:LAN ON SYSTem:COMMunicate:USB:LAN:ADD? SYST:COMM:USB:LAN:ADD? 192.168.123.1</p>
<p>Command Syntax Description</p> <p>Parameters Parameter Format Example</p>	<p>SYSTem:COMMunicate:USB:LAN:APPLY Applies IP settings for Virtual USB Lan interface.</p> <p>None N/A SYST:COMM:USB:LAN:APP</p>
<p>Command Syntax Description</p> <p>Parameters Parameter Format Example Query Format Returned Data Format Query Example</p>	<p>SYSTem:COMMunicate:USB:LAN:MASK Sets the embedded webserver virtual IP Mask Address for USB interface.</p> <p>IP Mask <cr> SYST:COMM:USB:LAN ON SYSTem:COMMunicate:USB:LAN:MASK? <cr> SYST:COMM:USB:LAN:MASK? 255.255.255.0</p>
<p>Command Syntax Description</p> <p>Parameters Parameter Format Example</p>	<p>SYSTem:COMMunicate:USB:VIRTualport:REStart Restarts the RS232 interface. Use after interface faults to reinitialize. Same as SYSTem:COMMunicate:SERial:REStart</p> <p>None n/a SYST:COMM:USB:VIRT:REST</p>

<p>Command Syntax Description</p> <p>Parameters Parameter Format Example</p>	<p>SYSTem:COMMunicate:USB:LAN:REStart Restarts the LAN interface. Use after interface faults to reinitialize. Same as SYSTem:COMMunicate:LAN:REStart</p> <p>None n/a SYST:COMM:USB:LAN:REST</p>
<p>Command Syntax Description</p> <p>Parameters Parameter Format Example</p>	<p>SYSTem:COMMunicate:USB:LAN:REStart:TELNET Restarts LAN Telnet interface. Use after interface faults to reinitialize. Same as SYSTem:COMMunicate:LAN:REStart:TELNET</p> <p>None n/a SYST:COMM:USB:LAN:REST:TELNET</p>
<p>Command Syntax Description</p> <p>Parameters Parameter Format Example</p>	<p>SYSTem:COMMunicate:USB:LAN:REStart:WEB Restarts LAN Telnet interface. Use after interface faults to reinitialize. Same as SYSTem:COMMunicate:LAN:REStart:WEB</p> <p>None n/a SYST:COMM:USB:LAN:REST:WEB</p>

8.11.11 Communication GPIB Commands

<p>Command Syntax Description Parameters Parameter Format Example Query Format Returned Data Format Query Example</p>	<p>SYSTem:COMMunicate:GPIB:ADDress <nr1> This command sets the GPIB address. < 1..30 > <nr1> SYST:COMM:GPIB:ADD 5 SYSTem:COMMunicate:GPIB:ADDress? <nr1> SYST:COMM:GPIB:ADD? 5</p>
<p>Command Syntax Description Parameters Parameter Format Example Query Format Returned Data Format Query Example</p>	<p>SYSTem:COMMunicate:GPIB:ENABle Enables GPIB interface. < 0 OFF 1 ON > SYST:COMM:GPIB:ENAB 1 SYSTem:COMMunicate:GPIB:ENABle? SYST:COMM:GPIB:ENAB? 1</p>

Command Syntax	SYSTem:COMMunicate:GPIB:BAUDrate
Description	Sets the internal serial link speed between the GPIB interface and the front panel processor. This setting is set to 921600 bps as a default and should only be changed to a lower setting if there is a problem with the GPIB interface not working reliably.
Parameters	< 1200 1800 2400 4800 9600 14400 19200 38400 57600 62500 115200 230400 460800 500000 576000 921600 >
Parameter Format	<nr1>
Example	SYST:COMM:GPIB:BAUD 921600
Query Format	SYSTem:COMMunicate:GPIB:BAUDrate?
Returned Data Format	<nr1>
Query Example	SYST:COMM:GPIB:BAUD? 921600
Command Syntax	SYSTem:COMMunicate:GPIB:REStart
Description	Restarts the GPIB interface. Use after interface faults to reinitialize.
Parameters	None
Parameter Format	n/a
Example	SYST:COMM:GPIB:REST

8.11.12 Communication CAN / CAN-FD Commands

Command Syntax	SYSTem:COMMunicate:CANFD:ENABLE
Description	This command turns remote control via CAN or CAN FD interface on or off. To control the power source through its CAN interface, this state has to on (1).
Parameters	< 0 OFF 1 ON >
Parameter Format	
Example	SYST:COMM:CANFD:ENAB ON
Query Format	SYSTem:COMMunicate:CANFD:ENABLE?
Returned Data Format	<nr1>
Query Example	SYST:COMM:CANFD:ENAB? 1
Command Syntax	SYSTem:COMMunicate:CANFD:MEASure:RATE
Description	This command sets the bit rate measurement on the CAN FD interface to on or off.
Parameters	< 0 OFF 1 ON >
Parameter Format	
Example	SYST:COMM:CANFD:MEAS:RATE ON
Query Format	SYSTem:COMMunicate:CANFD:MEASure:RATE?
Returned Data Format	<nr1>
Query Example	SYST:COMM:CCANFD:MEAS:RATE? 1
Command Syntax	SYSTem:COMMunicate:CANFD:MEASure:ENABLE
Description	This command enables or disables the measurement on the CAN FD interface.
Parameters	< 0 OFF 1 ON >
Parameter Format	
Example	SYST:COMM:CANFD:MEAS:ENAB 1
Query Format	SYSTem:COMMunicate:CANFD:MEASure:ENABLE?
Returned Data Format	<nr1>
Query Example	SYST:COMM:CCANFD:MEAS:ENAB? 1
Command Syntax	SYSTem:COMMunicate:CANFD:REStart
Description	This command restarts (resets) the CAN FD interface.
Parameters	None
Parameter Format	n/a
Example	SYST:COMM:CANFD:REST
Query Format	N/A

8.11.13 System Firmware Commands

Query Format	SYSTem:FW:POWER[:VERsion]?
Description	This command returns the firmware revision of the power converter DSP's. This information is for reference only.
Returned Data Format	<cr>-<cr>
Query Example	SYST:FW:POWER:VER? 81.0.0.RC8-77.1.0
Query Format	SYSTem:FW:FRONTPANEL:VERsion?
Description	This command returns the firmware revision of front panel controller processor. This information is for reference only.
Returned Data Format	<cr>
Query Example	SYST:FW:FRONTPANEL:VER? 2.0.0
Query Format	SYSTem:FW:FRONTPANEL:APPS:VERsion?
Description	This command returns the firmware revision of front panel controller user interface application. This information is for reference only. Note: This revision number is also returned as part of the *IDN? query response.
Returned Data Format	<cr>
Query Example	SYST:FW:FRONTPANEL:APPS:VER? 2.0.0
Query Format	SYSTem:HWREVision?
Description	This command returns the hardware revision (build) of the power source.
Returned Data Format	<nr2>
Query Example	SYST:HWREV? 0

8.11.14 System Remote Access Commands

<p>Command Syntax Description Parameters Parameter Format Example Query Format Returned Data Format Query Example</p>	<p>SYSTem:REMOte:ACCESS Sets remote access permission. <0 DISABLED 1 ENABLED> SYST:REM:ACCESS 1 SYSTem:REMOte:ACCESS? <cr> SYST:REM:ACCESS? 1</p>
<p>Command Syntax Description Parameters Parameter Format Example Query Format</p>	<p>SYSTem:REMOte:ACCESS:REQuest This commands results in a pop up dialog on the front panel display requesting the local user to ACCEPT. Confirms presence of a person at the location of the instrument. Alias name. (This argument is optional) <cr> SYSTem:REMOte:ACCESS:REQuest None</p>
<p>Command Syntax Description Parameters Parameter Format Example Query Format</p>	<p>SYSTem:REMOte:ACCESS:LOGIN This command uses a password as an argument to request access to the instrument. The password can be set on the front panel or using the SYSTem:REMOte:PASSword command Password <nr1> SYSTem:REMOte:ACCESS:LOGIN 1234 None</p>
<p>Command Syntax Description Parameters Parameter Format Example Query Format Returned Data Format Query Example</p>	<p>SYSTem:REMOte:ACCESS:MESSAge <cr> Allows a user specific message to be displayed at the bottom of the Access Control Browser dialog informing anyone requesting access whom to contact. User Message <cr> SYSTem:REMOte:ACCESS:MESS “Unit is used by John. Please contact 123456789.” SYSTem:REMOte:ACCESS:MESSAge? <cr> SYST:REM:ACCESS:MESS? “Unit is used by John. Please contact 123456789.”</p>

Command Syntax	SYSTem:REMote:ACCESS:MONItor
Description	Enables or disables remote access monitor mode only. ON by default for backward compatibility.
Parameters	< 0 OFF 1 ON >
Parameter Format	 or <cr>
Example	SYSTem:REMote:ACCESS:MONI ON
Query Format	SYSTem:REMote:ACCESS:MONItor?
Returned Data Format	
Query Example	SYST:REM:ACCESS:MONI? 1
Command Syntax	SYSTem:REMote:FTP:ENable
Description	Enable/disable the FTP service.
Parameters	<0 OFF 1 ON>
Parameter Format	
Example	SYST:REM:FTP:ENA 1
Query Format	SYSTem:REMote:FTP:ENable?
Returned Data Format	
Query Example	SYST:REM:FTP:ENA? 1
Command Syntax	SYSTem:REMote:FTP:PASSword
Description	Sets remote FTP access permission password.
Parameters	password
Parameter Format	<cr>
Example	SYST:REM:FTP:PASS temporal
Query Format	SYSTem:REMote:FTP:PASSword?
Returned Data Format	<cr>
Query Example	SYST:REM:FTP:PASS? temporal
Command Syntax	SYSTem:REMote:SMB:ENable
Description	Enable/disable the samba service.
Parameters	<0 OFF 1 ON>
Parameter Format	
Example	SYST:REM:FTP:ENA 1
Query Format	SYSTem:REMote:SMB:ENable?
Returned Data Format	
Query Example	SYST:REM:SMB:ENA? temporal

Command Syntax	SYSTem:REMOte:SMB:PASSword
Description	Sets remote Samba services access permission password
Parameters	password
Parameter Format	<cr>
Example	SYST:REM:SMB:PASS temporal
Query Format	SYSTem:REMOte:SMB:PASSword?
Returned Data Format	<cr>
Query Example	SYST:REM:SMB:PASS? temporal

8.11.15 System Regional Setting Commands

These commands are used to set regional setting for Dates, Times and Decimal separators. They are relevant when exporting or importing CSV files for use in applications like MS Excel or MS Word.

Command: **SYSTem:REGion:DATEFormat <FORMAT>**

Sets the date display format as either **DD/MM/YYYY** (Asia) EU or **MM/DD/YYYY** (USA)

Example: SYST:REG:DATE DD/MM/YYYY

Query: **SYSTem:REGion:DATEFormat?**

Example: SYST:REG:DATE?
DD/MM/YYYY

Command: **SYSTem:REGion:DATEFormat:CATalog?**

Returns: MM/DD/YYYY,DD/MM/YYYY

Command: **SYSTem:REGion:DECImsymbol <SEPARATOR>**

Sets the decimal separator to either a comma (Asia, EU) or a period (USA). Parameters are "." Or ",".

Example: SYST:REG:DECI ","

Query: **SYSTem:REGion:DECImsymbol?**

Returns decimal separator setting.

Examples SYST:REG:DATE?
,

8.11.16 Miscellaneous System Commands

8.11.16.1 System Memory Commands

Query Format	SYSTem:MEMory:CATalog?
Description	This command returns the available memory types catalog.
Returned Data Format	<cr>,...,<cr>
Query Example	SYST:MEM:CAT? INTERNAL, RAM

Command Syntax	SYSTem:MEMory:REMove
Description	This command unmounts system memory.
Returned Data Format	<cr>,...,<cr>
Query Format	None

8.11.16.2 System Delete Commands

Command Syntax	SYSTem:DELeTe <PATH>
Description	This command deletes a file or folder. The path or filename can be between double quotation marks or not.
Parameters	PATH or FILE
Parameter Format	<cr>
Example	SYST:DEL internal/program/program_1.xml SYST:DEL "internal/program/program_1.xml" SYST:DEL temporal/program/program_1.xml SYST:DEL "temporal/program/program_1.xml"
Query Format	none

8.11.16.3 System File Commands

Query Format	SYSTem:FILE:TYPE? <MEM>
Description	This command returns the file type in numeric available memory types catalog.
Returned Data Format	<nr1>
Query Example	SYST:FILE:TYPE? RAM 0 SYST:FILE:TYPE? INTERNAL 0

8.11.16.4 System Screen Commands

Command Syntax	SYSTem:SCREENshot
Description	This command takes a screen shot of the LCD display. The LCD image is saved as a ".png" format image file to folder "internal/screenshots"
Parameters	None
Parameter Format	N/A
Example	SYST:SCREEN
Query Format	none

8.11.17 System Import / Export Commands

These commands allow complete system configurations to be exported or imported.

Command Syntax	SYSTem:EXPort <OPT: CONFIGURATION, OPT: WAVEFORMS, OPT: PROGRAMS, OPT: SETPOINTS, OPT: [NAME, NAMEFILE]>
Description	Exports complete record of system configuration of the power source to a compressed file. If argument name is omitted it is stored in temporal/DATE—TIME.7z otherwise in temporal/NAMEFILE.7z. The others arguments indicate what is going to be exported, if none of them are passed all is going to be exported.
Parameters	<OPT: CONFIGURATION, OPT: WAVEFORMS, OPT: PROGRAMS, OPT: SETPOINTS, OPT: [NAME, NAMEFILE]>
Parameter Format Example	<cr> SYST:EXPORT SYST:EXPORT NAME,TEST SYST:EXPORT SETPOINTS,NAME,TEST2 SYST:EXPORT SETPOINTS, WAVEFORMS,NAME,TEST3
Command Syntax	SYSTem:IMPort <OPT: CONFIGURATION, OPT: WAVEFORMS, OPT: PROGRAMS, OPT: SETPOINTS, [NAME, NAMEFILE]>
Description	Imports complete system configuration records of the power source. The compressed file has to be in /temporal/NAMEFILE.7z. The other others arguments indicate what will be imported, if none of them are passed all is going to be imported.
Parameters	<OPT: CONFIGURATION, OPT: WAVEFORMS, OPT: PROGRAMS, OPT: SETPOINTS, [NAME, NAMEFILE]>
Parameter Format Example	<cr> SYST:IMPORT NAME,TEST

8.11.18 Miscellaneous Remote Restart Commands

Command Syntax	SYSTem:COMMunicate:LXI:REStart
Description	Restarts the LXI interface.
Parameters	None
Parameter Format Example	n/a SYST:COMM:LXI:REST
Command Syntax	SYSTem:REMote:FTP:REStart
Description	Restarts the FTP Server.
Parameters	None
Parameter Format Example	n/a SYST:REM:FTP:REST
Command Syntax	SYSTem:REMote:SMB:REStart
Description	Restarts the Samba Server.
Parameters	None
Parameter Format Example	n/a SYST:REM:SMB:REST

Command Syntax	SYSTem:RESTART
Description	Restarts the SPCI Processor.
Parameters	None
Parameter Format	n/a
Example	SYST:RESTART

Command Syntax	SYSTem:INTERFace:REStArt
Description	Restarts the Display Processor.
Parameters	None
Parameter Format	n/a
Example	SYST:INTERF:REST

8.12 Auxiliary I/O System Commands

Commands specific to the auxiliary I/O functions are listed in this section. The function of these I/O inputs and outputs may change with the Operation Mode setting.

- For Voltage Source mode, I/O will control voltage settings
- For Current Source mode, I/O lines will control current or power
- For Active Load mode, the lines will contro Current, Power or Resistance depeding on the selected Load Operation mode.

8.12.1 System Analog & Digital IO Commands

```

SYSTem:AIO
  :INput[1 | 2 | 3 |.4][?]
    :CATalog?
    :GAIN[?]
      :DEFault?
      :MAXimum?
      :MINimum?
    : OFFSET[?]
      :DEFault?
      :MAXimum?
      :MINimum?
    :RANGe[?]
      :DEFault?
      :MAXimum?
      :MINimum?
    :UNITs?
    :VOLTage?
  :OUTput[1 | 2 | 3 |.4][?]
    :CATalog?
    :GAIN[?]
      :DEFault?
      :MAXimum?
      :MINimum?
    :OFFSET[?]
      :DEFault?
      :MAXimum?
      :MINimum?
    :RANGe[?]
  
```



```

:DEFault?
:MAXimum?
:MINimum?

:UNITs?
:VOLTage?

SYSTem:DIO
:INput[1 | 2 | 3 | .4][?]
:FALLing[?]
:FILtersize[?]
:DEFault?
:MAXimum?
:MINimum?

:RISing[?]
:OUTput[1 | 2 | 3 | .4][?]
:CATalog?
:INVert[?]
:STATe?

:REMote
:ENable[?]
:INHibit[?]

:STROBE
:OUTPutstate[?]
:SOURce[?]
:TRANsient[?]

```

8.12.1.1 SYSTem:AIO:Input

Command Syntax	SYSTem:AIO:INput[n] <cr>
Description	Sets the AZX parameter to be controlled by the analog input.
Parameters	[CURR:LIM CURR:LIM1 CURR:LIM2 CURR:LIM3 FREQ KVA:LIM KVA:LIM1 KVA:LIM2 KVA:LIM3 OFF PHAS2 PHAS3 POW:LIM POW:LIM1 POW:LIM2 POW:LIM3 VOLT:AC VOLT:AC1 VOLT:AC2 VOLT:AC3 VOLT:DC VOLT:DC1 VOLT:DC2 VOLT:DC3] See the “SYSTem:AIO:INput:CATalog?” command response for a list of supported parameters.
Parameter Format	<cr>
Example	SYST:AIO:IN1 VOLTAGE
Query Format	SYSTem:AIO:INput[n]?
Returned Data Format	<cr>
Query Example	SYST:AIO:IN1? VOLTAGE
Query Format	SYSTem:AIO:INput:CATalog?
Description	Returns list of available analog inputs
Returned Data Format	<cr>
Query Example	SYST:AIO:IN:CAT? CURR:LIM,CURR:LIM1,CURR:LIM2,CURR:LIM3,FREQ,KVA:LIM,KVA:LIM1,KVA:LIM2,KVA:LIM3,OFF,PHAS2,PHAS3,POW:LIM,POW:LIM1,POW:LIM2,POW:LIM3,VOLT:AC,VOLT:AC1,VOLT:AC2,VOLT:AC3,VOLT:DC,VOLT:DC1,VOLT:DC2,VOLT:DC3

<p>Command Syntax Description</p> <p>Parameters Parameter Format Example Query Format Returned Data Format Query Example</p>	<p>SYSTem:AIO:INput[n]:GAIN <nr2> Sets the full-scale gain of the AZX parameter controlled by the analog input.</p> <p>Full scale value <nr2> SYST:AIO:IN1:GAIN 230.0</p> <p>SYSTem:AIO:INput[n]:GAIN? <nr2> SYST:AIO:IN1:GAIN? 230.00</p>
<p>Query Format Description Parameters Returned Data Format Query Example</p>	<p>SYSTem:AIO:INput[n]:GAIN:DEFault? Returns the default full-scale gain for the specified analog input.</p> <p>None <nr2> SYST:AIO:IN1:GAIN:DEF? 440.0</p>
<p>Query Format Description Parameters Returned Data Format Query Example</p>	<p>SYSTem:AIO:INput[n]:GAIN:MAXimum? Returns the maximum full-scale gain for the specified analog input.</p> <p>None n/a SYST:AIO:IN1:GAIN:MAX? 100000.000000</p>
<p>Query Format Description Parameters Returned Data Format Query Example</p>	<p>SYSTem:AIO:INput[n]:GAIN:MINimum? Returns the minimum full-scale gain for the specified analog input.</p> <p>None n/a SYST:AIO:IN1:GAIN:MIN? -100000.000000</p>
<p>Command Syntax Description Parameters Parameter Format Example Query Format Returned Data Format Query Example</p>	<p>SYSTem:AIO:INput[n]:OFFSET <nr2> Sets the offset of the AZX parameter controlled by the analog input.</p> <p>Offset <nr2> SYST:AIO:IN1:OFFSET 50.0</p> <p>SYSTem:AIO:INput[n]:OFFSET? <nr2> SYST:AIO:IN1:OFFSET? 15.00</p>

Query Format	SYSTem:AIO:INput[n]:OFFSET:DEFault?
Description	Returns the default offset for the specified analog input.
Parameters	None
Returned Data Format	n/a
Query Example	SYST:AIO:IN1:OFFSET:DEF? 15.0
Query Format	SYSTem:AIO:INput[n]:OFFSET:MAXimum?
Description	Returns the maximum offset for the specified analog input.
Parameters	None
Returned Data Format	n/a
Query Example	SYST:AIO:IN1:OFFSET:MAX? 100000.000000
Query Format	SYSTem:AIO:INput[n]:OFFSET:MINimum?
Description	Returns the minimum offset for the specified analog input.
Parameters	None
Returned Data Format	n/a
Query Example	SYST:AIO:IN1:OFFSET:MIN? -100000.000000
Command Syntax	SYSTem:AIO:INput[n]:RANGe <nr2>
Description	Sets the range of the specified analog input. Available range is 0.0 ~ 10.
Parameters	Offset
Parameter Format	<nr2>
Example	SYST:AIO:IN1:RANG 50.0
Query Format	SYSTem:AIO:INput[n]:RANGe?
Returned Data Format	<nr2>
Query Example	SYST:AIO:IN1:RANG? 10.00
Query Format	SYSTem:AIO:INput[n]:RANGe:DEFault?
Description	Returns the default range for the specified analog input.
Parameters	None
Returned Data Format	n/a
Query Example	SYST:AIO:IN1:RANG:DEF? 0.0
Query Format	SYSTem:AIO:INput[n]:RANGe:MAXimum?
Description	Returns the maximum range for the specified analog input.
Parameters	None
Returned Data Format	n/a
Query Example	SYST:AIO:IN1:RANG:MAX? 10.0

Query Format	SYSTem:AIO:INput[n]:RANGe:MINimum?
Description	Returns the minimum range for the specified analog input.
Parameters	None
Returned Data Format	n/a
Query Example	SYST:AIO:IN1:RANG:MIN? 0.0
Query Format	SYSTem:AIO:INput[n]:UNITs?
Description	Returns the assigned unit for the specified analog input port.
Parameters	None
Returned Data Format	<cr>
Query Example	SYST:AIO:IN2:UNIT? Vrms
Query Format	SYSTem:AIO:INput[n]:VOLTage?
Description	Returns the voltage value at the specified analog input port.
Parameters	None
Returned Data Format	<nr2>
Query Example	SYST:AIO:IN2:VOLT? 4.895

8.12.1.2 SYSTem:AIO:OUTput

Command Syntax	SYSTem:AIO:OUTput[n] <cr>
Description	Sets the AZX measurement that is mapped to each analog output port.
Parameters	[MEAS:CURR1? MEAS:CURR2? MEAS:CURR3? MEAS:CURR:CREST1? MEAS:CURR:CREST2? MEAS:CURR:CREST3? MEAS:CURR:CREST? MEAS:CURR:DC1? MEAS:CURR:DC2? MEAS:CURR:DC3? MEAS:CURR:DC? MEAS:CURR:PEAK1? MEAS:CURR:PEAK2? MEAS:CURR:PEAK3? MEAS:CURR:PEAK? MEAS:CURR? MEAS:FREQ? MEAS:KVA1? MEAS:KVA2? MEAS:KVA3? MEAS:KVA? MEAS:PF1? MEAS:PF2? MEAS:PF3? MEAS:PF? MEAS:POW1? MEAS:POW2? MEAS:POW3? MEAS:POW? MEAS:VLL:AC1? MEAS:VLL:AC2? MEAS:VLL:AC3? MEAS:VLL:AC? MEAS:VLL:ACDC1? MEAS:VLL:ACDC2? MEAS:VLL:ACDC3? MEAS:VLL:ACDC? MEAS:VLL:DC1? MEAS:VLL:DC2? MEAS:VLL:DC3? MEAS:VLL:DC? MEAS:VOLT:AC1? MEAS:VOLT:AC2? MEAS:VOLT:AC3? MEAS:VOLT:AC? MEAS:VOLT:ACDC1? MEAS:VOLT:ACDC2? MEAS:VOLT:ACDC3? MEAS:VOLT:ACDC? MEAS:VOLT:DC1? MEAS:VOLT:DC2? MEAS:VOLT:DC3? MEAS:VOLT:DC?] See the “SYSTem:AIO:OUTput:CATalog?” command for a list of available parameters.
Parameter Format	<cr>
Example	SYST:AIO:OUT1 VRMS
Query Format	SYSTem:AIO:OUTput[n]?
Returned Data Format	<cr>
Query Example	SYST:AIO:OUTP? VRMS
Query Format	SYSTem:AIO:OUTput:CATalog?
Description	Returns list of available analog outputs
Returned Data Format	<cr>
Query Example	SYST:AIO:OUT:CAT? MEAS:CURR1?,MEAS:CURR2?,MEAS:CURR3?,MEAS:CURR:CREST1?,MEAS:CURR:CREST2?,MEAS:CURR:CREST3?,MEAS:CURR:CREST?,MEAS:CURR:DC1?,MEAS:CURR:DC2?,MEAS:CURR:DC3?,MEAS:CURR:DC?,MEAS:CURR:PEAK1?,MEAS:CURR:PEAK2?,MEAS:CURR:PEAK3?,MEAS:CURR:PEAK?,MEAS:CURR?,MEAS:FREQ?,MEAS:KVA1?,MEAS:KVA2?,MEAS:KVA3?,MEAS:KVA?,MEAS:PF1?,MEAS:PF2?,MEAS:PF3?,MEAS:PF?,MEAS:POW1?,MEAS:POW2?,MEAS:POW3?,MEAS:POW?,MEAS:VLL:AC1?,MEAS:VLL:AC2?,MEAS:VLL:AC3?,MEAS:VLL:AC?,MEAS:VLL:ACDC1?,MEAS:VLL:ACDC2?,MEAS:VLL:ACDC3?,MEAS:VLL:ACDC?,MEAS:VLL:DC1?,MEAS:VLL:DC2?,MEAS:VLL:DC3?,MEAS:VLL:DC?,MEAS:VOLT:AC1?,MEAS:VOLT:AC2?,MEAS:VOLT:AC3?,MEAS:VOLT:AC?,MEAS:VOLT:ACDC1?,MEAS:VOLT:ACDC2?,MEAS:VOLT:ACDC3?,MEAS:VOLT:ACDC?,MEAS:VOLT:DC1?,MEAS:VOLT:DC2?,MEAS:VOLT:DC3?,MEAS:VOLT:DC?

<p>Command Syntax Description</p> <p>Parameters Parameter Format Example Query Format Returned Data Format Query Example</p>	<p>SYSTem:AIO:OUTput[n]:GAIN <nr2> Sets the full-scale gain of the AZX measurement mapped to the analog input.</p> <p>Full scale value <nr2> SYST:AIO:OUT1:GAIN 230.0</p> <p>SYSTem:AIO:OUTput[n]:GAIN? <nr2> SYST:AIO:OUT1:GAIN? 425.0000</p>
<p>Query Format Description</p> <p>Parameters Returned Data Format Query Example</p>	<p>SYSTem:AIO:OUTput[n]:GAIN:DEFault? Returns the default full-scale gain for the specified analog output port.</p> <p>None n/a SYST:AIO:OUT1:GAIN:DEF? 425.0000</p>
<p>Query Format Description Parameters Returned Data Format Query Example</p>	<p>SYSTem:AIO:OUTput[n]:GAIN:MAXimum? Returns the maximum gain for the specified analog output port.</p> <p>None n/a SYST:AIO:OUT1:GAIN:MAX? 100000.00000</p>
<p>Query Format Description Parameters Returned Data Format Query Example</p>	<p>SYSTem:AIO:OUTput[n]:GAIN:MINimum? Returns the minimum gain for the specified analog output port.</p> <p>None n/a SYST:AIO:OUT1:GAIN:MIN? -100000.00000</p>
<p>Command Syntax Description Parameters Parameter Format Example Query Format Returned Data Format Query Example</p>	<p>SYSTem:AIO:OUTput[n]:OFFSET <nr2> Sets the offset of the specified analog output port.</p> <p>Offset <nr2> SYST:AIO:OUT1:OFFSET 50.0</p> <p>SYSTem:AIO:OUTput[n]:OFFSET? <nr2> SYST:AIO:OUT1:OFFSET? 50.00</p>

<p>Query Format Description Parameters Returned Data Format Query Example</p>	<p>SYSTem:AIO:OUTput[n]:OFFSET:DEFault? Returns the default offset for the specified analog output port. None n/a SYST:AIO:OUT1:OFFSET:DEF? 0.00000</p>
<p>Query Format Description Parameters Returned Data Format Query Example</p>	<p>SYSTem:AIO:OUTput[n]:OFFSET:MAXimum? Returns the maximum gain for the specified analog output port. None n/a SYST:AIO:OUT1:GAIN:MAX? 100000.00000</p>
<p>Query Format Description Parameters Returned Data Format Query Example</p>	<p>SYSTem:AIO:OUTput[n]:OFFSET:MINimum? Returns the minimum gain for the specified analog output port. None n/a SYST:AIO:OUT1:GAIN:MIN? -100000.00000</p>
<p>Command Syntax Description Parameters Parameter Format Example Query Format Returned Data Format Query Example</p>	<p>SYSTem:AIO:OUTput[n]:GAIN <nr2> Sets the full-scale gain of the specified analog output port. Full scale value <nr2> SYST:AIO:OUT1:GAIN 230.0 SYSTem:AIO:OUTput[n]:GAIN? <nr2> SYST:AIO:OUT1:GAIN? 230.00</p>
<p>Query Format Description Parameters Returned Data Format Query Example</p>	<p>SYSTem:AIO:OUTput[n]:GAIN:DEFault? Returns the default full-scale gain for the specified analog output. None <nr2> SYST:AIO:OUT1:GAIN:DEF? 425.00000</p>
<p>Query Format Description Parameters Returned Data Format Query Example</p>	<p>SYSTem:AIO:OUTput[n]:GAIN:MAXimum? Returns the maximum full-scale gain for the specified analog output. None n/a SYST:AIO:OUT1:GAIN:MAX? 100000.00000</p>

Query Format	SYSTem:AIO:OUTput[n]:GAIN:MINimum?
Description	Returns the minimum full-scale gain for the specified analog output.
Parameters	None
Returned Data Format	n/a
Query Example	SYST:AIO:OUT1:GAIN:MIN? -100000.00000

Query Format	SYSTem:AIO:OUTput[n]:UNITs?
Description	Returns the assigned unit for the specified analog output port.
Parameters	None
Returned Data Format	<cr>
Query Example	SYST:AIO:OUT2:UNIT? Vrms

Query Format	SYSTem:AIO:OUTput[n]:VOLTage?
Description	Returns the voltage at the analog output port.
Parameters	None
Returned Data Format	<nr2>
Query Example	SYST:AIO:OUT2:VOLT? 7.2590

8.12.1.3 SYSTem:DIO:Input

Query Format	SYSTem:DIO:INput[n]?
Description	Queries status of Digital Input 1, 2 or 3. If I/O number is omitted, all three input values are returned. n = 1, 2 or 3.
Parameters	none
Returned Data Format	<cr>
Parameter Format	<nr1>
Query Example	SYST:DIO:IN2? 0

Command Syntax	SYSTem:DIO:INput[n]:FALLing <cr>
Description	SYSTem:DIO:INput[n]:RISing <cr> Sets the SCPI command to be executed at the rising or falling event of that digital input [n]. n = 1, 2 or 3.
Parameters	SCPI command string
Parameter Format	<cr>
Example	SYST:DIO:IN1:FALL "OUTP 0" SYST:DIO:IN1:RIS "OUTP 1" These settings will enable the output at the rising edge of the pulse and disable it at the falling edge.
Query Format	SYSTem:DIO:INput[n]:FALLing? SYSTem:DIO:INput[n]:RISing?
Returned Data Format	<cr>
Query Example	SYST:DIO:IN1:RIS? OUTP 1 SYST:DIO:IN1:FALL? -
Command Syntax	SYSTem:DIO:INput[n]:FILtersize <nr1>
Description	Defines the time in ms (milliseconds) that the digital input has to keep the state after a transition in order to generate the event. If filtersize is zero, then the event is immediately generated, otherwise the specified time will prevent short pulses from generating events. This is useful in noisy environments and also if the digital signal is controlled by a switch or a mechanical actuator.
Parameters	0 – 1000
Parameter Format	<nr1>
Example	SYST:DIO:IN1:FIL 8
Query Format	SYSTem:DIO:INput[n]:FILtersize?
Returned Data Format	<nr1>
Query Example	SYST:DIO:IN1:FIL? 8
Query Format	SYSTem:DIO:INput[n]:FILtersize:DEFault?
Description	Returns the default filter size value.
Returned Data Format	<nr1>
Query Example	SYST:DIO:IN1:FIL:DEF? 0
Query Format	SYSTem:DIO:INput[n]:FILtersize:MAXimum?
Description	Returns the maximum allowed filter size value.
Returned Data Format	<nr1>
Query Example	SYST:DIO:IN1:FIL:MAX? 1000

Query Format	SYSTem:DIO:INput[n]:FILtersize:MINimum?
Description	Returns the minimum allowed filter size value.
Returned Data Format	<nr1>
Query Example	SYST:DIO:IN1:FIL:MIN? 1

8.12.1.4 SYSTem:DIO:OUTput

Command Syntax	SYSTem:DIO:OUTput[n] <MODE>
Description	Sets output value of digital output n. n = 1 or 2.
Parameter 1	MODE The mode determines when an output is generated. Available MODE settings are: <ul style="list-style-type: none"> • 1, ON, 0, OFF it is used as general purpose output. [0 LOW 1 HIGH] • OUTPUT_STATE indicates output enabled(1) or disabled(0). • FORM indicates single(1) or split/three(0). • FAULT indicates fault(1) or no fault(0). • TRANSIENT indicates when a transient is running/paused/stepping(1) or stopped(0). • PROGRAM indicates when a program is in execution at steady state level(1) or manual mode(0). • REMOTE indicates remote(1) or local(0) state Defaults are: OUTPUT1: OUTPUT_STATE OUTPUT2: FORM
Parameter Format	<cr>
Example	SYST:DIO:OUT1 FAULT
Query Format	SYSTem:DIO:OUTput[n]?
Description	Returns settings for selected pin number n
Returned Data Format	<nr1>
Query Example	SYST:DIO:OUT1? OUTPUT STATE,NON-INVERTING
Query Format	SYSTem:DIO:OUTput:CATalog?
Description	Returns list of available digital outputs
Returned Data Format	<cr>
Query Example	SYST:DIO:OUT:CAT? COUPLING,FAULT,FORM,HIGH,LOW,OUTPUT STATE,PROGRAM,REMOTE,TRANSIENT

Command Syntax	SYSTem:DIO:OUTput[n]:INVert
Description	Inverts the logic polarity of the selected digital output.
Parameters	[0 NORMAL 1 INVERT]
Example	SYST:DIO:OUT1 1
Query Format	SYSTem:DIO:OUTput[n]:INVert?
Description	Returns logic inversion setting
Returned Data Format	<nr1>
Query Example	SYST:DIO:OUT1:INV? 1
Query Format	SYSTem:DIO:OUTput[n]:STATe?
Description	Returns logic level of selected output pin.
Returned Data Format	
Query Example	SYST:DIO:OUT1:STAT? 1

8.12.1.5 SYSTem:DIO:REMOte

Command Syntax	SYSTem:DIO:REMOte:ENABle
Description	Turns the remote enable state on or off
Parameters	< 0 OFF 1 ON >
Parameter Format	
Example	SYST:DIO:REMOte:ENABle 1
Query Format	SYSTem:DIO:REMOte:ENABle?
Returned Data Format	
Query Example	SYST:DIO:REM:ENA? 1
Command Syntax	SYSTem:DIO:REMOte:INHibit
Description	Turns the remote inhibit state on or off
Parameters	< 0 OFF 1 ON >
Parameter Format	
Example	SYST:DIO:REMOte:INHibit 1
Query Format	SYSTem:DIO:REMOte:INHibit?
Returned Data Format	
Query Example	SYST:DIO:REM:INH? 1

8.12.1.6 SYSTem:DIO:STROBE

Command Syntax	SYSTem:DIO:STROBE:OUTPustate
Description	Sets the function strobe mode active when the output relay changes state
Parameters	< 0 OFF 1 ON >
Parameter Format	
Example	SYST:DIO:STROBE:OUTP 1
Query Format	SYSTem:DIO:STROBE:OUTPustate?
Returned Data Format	
Query Example	SYST:DIO:STROBE:OUTP? 1
Command Syntax	SYSTem:DIO:STROBE:SOURce
Description	Sets the function strobe mode to program changes.
Parameters	< 0 OFF 1 ON >
Parameter Format	
Example	SYST:DIO:STROBE:SOUR 1
Query Format	SYSTem:DIO:STROBE:SOURce?
Returned Data Format	
Query Example	SYST:DIO:STROBE:SOUR? 1
Command Syntax	SYSTem:DIO:STROBE:TRANsient
Description	Sets the function strobe mode to generate an output at the start of a transient execution.
Parameters	< 0 OFF 1 ON >
Parameter Format	
Example	SYST:DIO:STROBE:TRAN 1
Query Format	SYSTem:DIO:STROBE:TRANsient?
Returned Data Format	
Query Example	SYST:DIO:STROBE:TRAN? 1

8.12.2 SOURce:SYNChronize Commands

```
SOURce:SYNChronize
  [:INput][?]
    :PHASEshift[?]
    :RANGE[?]
    :SOURCE[?]
    :SPeed[?]
    :STATe?
```

```
SOURce:SYNChronize
  :OUTPut[?]
```

8.12.2.1 SOURce:SYNChronize[:INput]

Command Syntax	SOURce:SYNChronize[:INput]
Description	This command enables or disables the external sync input mode.
Parameters	[0 OFF 1 ON]
Parameter Format	
Example	SOUR:SYNC 1
Query Format	SOURce:SYNChronize[:INput]?
Returned Data Format	
Query Example	SOUR:SYNC? 1

Command Syntax	SOURce:SYNChronize[:Input]:PHASEshift <nr2>
Description	Defines a fixed phase shift between phase A waveform generation and the external sync source. Used to calibrate any phase difference between the sync signal and the power source output on phase A.
Parameters	Phase shift
Parameter Format	<nr>
Example	SOUR:SYNC:PHASE 2.8
Query Format	SOURce:SYNChronize[:Input]:PHASEshift?
Returned Data Format	<nr2>
Query Example	SOUR:SYNC:PHASE? 0.5

<p>Command Syntax Description</p>	<p>SOURce:SYNChronize[:Input]:RANGe <nr2> Allows configuration of how much the synchronization engine is able to deviate from the AZX programmed frequency. This helps to keep the waveform frequency under control, even if the external source is not present all the time. The synchronization engine is limited to frequencies of FSETPOINT +/- FRANGE.</p>
<p>Parameters Parameter Format Example Query Format Returned Data Format Query Example</p>	<p>Range in Hz <nr2> SOUR:SYNC:RANG 5.0 SOURce:SYNChronize[:Input]:RANGe? <nr2> SOUR:SYNC:RANGe? 10.000</p>
<p>Command Syntax Description</p>	<p>SOURce:SYNChronize[:Input]:SOURce <cr> This command selects either the external sync TTL (1) or the internal AC line sync (0) mode. The internal AC sync signal is derived from the power sources three phase L-L voltages so a phase adjustment for Phase A output will be needed using the SOURce:SYNChronize[:Input]:PHASEshift command.</p>
<p>Parameters Parameter Format Example Query Format Returned Data Format Query Example</p>	<p>[0 AC 1 TTL] <cr> SOUR:SYNC:SOUR TTL SOURce:SYNChronize[:Input]:SOURce? <cr> SOUR:SYNC:SOUR? 1</p>
<p>Command Syntax Description</p>	<p>SOURce:SYNChronize[:Input]:SPeEd <nr2> Allows accelerating the speed of the internal synchronization engine (PLL) in case the external sync source is not constant and presents periodic or continuous changes. A slower speed improves the stability of the waveform frequency, so it is recommended to keep use the smallest possible speed values.</p>
<p>Parameters Parameter Format Example Query Format Returned Data Format Query Example</p>	<p>Speed (multiplier value) <nr1> Range is 1.000 ~ 10.000 SOUR:SYNC:SP 0.50 SOURce:SYNChronize[:Input]:SPeEd? <nr2> SOUR:SYNC:SP? 2.500</p>

Query Command	SOURce:SYNChronize[:Input]:STATe?
Description	This query only command returns the status of the Phase Lock Loop (PLL). A "0" response indicates the PLL has not locked on to the sync input yet. A 1 response indicates the PLL is locked.
Returned Data Format	
Returned Data	0 = PLL is not locked 1 = PLL is locked
Query Example	SOUR:SYNC:STAT? 1

8.12.2.2 SOURce:SYNChronize[:OUTput]

Command Syntax	SOURce:SYNChronize:OUTput
Description	This command enables the SYNC output
Query Format	SOURce:SYNChronize:OUTput?
Returned Data Format	
Returned Data	0 = SYNC output off 1 = SYNCoutput on
Query Example	SOUR:SYNC:OUT? 1

8.12.3 PROGram:TRANSient Triggers Commands

```

PROGram:TRANSient:TRIGger
  :Input[?]
    :IMMEDIATE[?]
    :AUTOrun[?]
  :OUTput[?]
  
```

8.12.3.1 PROGram:TRANSient

The following **PROGram:TRANSient:TRIGger** commands are available.

Command Syntax	PROGram:TRANSient:TRIGger:INput
Description	When the trigger input is active, this command selects the trigger input source mode as on or off. When ON, the external trigger input is enabled.
Parameters	[0 OFF 1 ON]
Parameter Format	
Example	PROG:TRAN:TRIG:IN 1
Query Format	PROGram:TRANSient:TRIGger:INput?
Returned Data Format	
Query Example	PROG:TRAN:TRIG:IN? 1
Command Syntax	PROGram:TRANSient:TRIGger:INput:IMMEDIATE
Description	When the trigger input is active, this command starts the transient segments immediately after the trigger input is received, without waiting for the zero crossing, as determined by the update phase setting. Refer to SOURce:UPDATEPHase
Parameters	[0 OFF 1 ON]
Parameter Format	
Example	PROG:TRAN:TRIG:IN:IMM 1
Query Format	PROGram:TRANSient:TRIGger:INput:IMMEDIATE?
Returned Data Format	
Query Example	PROG:TRAN:TRIG:IN:IMM? 1

Command Syntax Description	PROG:TRANSient:TRIGger:INput:AUTOrun When the trigger input is active and segments are running state, each trigger event (pulse) will automatically start a new sequence, without the need of a new RUN command before each trigger. The RUN command has to be executed only once, and then each subsequent trigger input event will cause a new segment sequence to run. Note: the trigger signal is level-sensitive; hence if it is kept high, it will continuously issue a trigger.
Parameters Parameter Format Example Query Format Returned Data Format Query Example	[0 OFF 1 ON] PROG:TRAN:TRIG:IN:AUTO 1 PROG:TRANSient:TRIGger:INput:AUTOrun? PROG:TRAN:TRIG:IN:AUTO? 1
Command Syntax Description	PROG:TRANSient:TRIGger:OUTput This command causes a trigger output pulse to be generated when a transient execution is started. Note that this output is used as a function strobe during steady state operation.
Parameters Parameter Format Example Query Format Returned Data Format Query Example	[0 OFF 1 ON] PROG:TRAN:TRIG:OUT 1 PROG:TRANSient:TRIGger:OUTput? PROG:TRAN:TRIG:OUT? 1

8.12.4 AUX I/O Calibration Commands

```

SYSTem:AIO
  :INPut#
    :CALibration
      :GAIN{?}
        :DEFault{?}
        :MAXimum
        :MINimum
      :OFFset{?}
        :DEFault{?}
        :MAXimum
        :MINimum
  :OUTput#
    :CALibration
      :GAIN{?}
        :DEFault{?}
        :MAXimum
        :MINimum
      :OFFset{?}
        :DEFault{?}
        :MAXimum
        :MINimum
  
```

8.12.4.1 SYSTem:AIO:INPut#:CALibration

Command Syntax	SYSTem:AIO:INput[n]:CALibration:GAIN <nr2>
Description	Calibrates the full scale gain of the AZX parameter controlled by the analog input.
Parameters	Reference
Parameter Format	<nr2>
Example	SYST:AIO:IN1:CAL:GAIN 100.0
Query Format	SYSTem:AIO:INput[n]:CALibration:GAIN?
	Returns calibration coefficient
Returned Data Format	<nr2>
Query Example	SYST:AIO:IN1:CAL:GAIN? 1.000
Query Command	SYSTem:AIO:INput[n]:CALibration:GAIN:DEFault?
	Returns default calibration coefficient value
Returned Data Format	<nr2>
Query Example	SYST:AIO:IN1:CAL:GAIN:DEF? 1.000
Query Command	SYSTem:AIO:INput[n]:CALibration:GAIN:MAXimum?
	Returns upper limit of calibration coefficient value
Returned Data Format	<nr2>
Query Example	SYST:AIO:IN1:CAL:GAIN:MAX? 1.000

Query Command	SYSTem:AIO:INput[n]:CALibration:GAIN:MINimum? Returns lower limit of calibration coefficient value
Returned Data Format	<nr2>
Query Example	SYST:AIO:IN1:CAL:GAIN:MIN? 0.000
Command Syntax Description	SYSTem:AIO:INput[n]:CALibration:OFFset <nr2> Calibrates the full scale gain of the AZX parameter controlled by the analog input.
Parameters	Reference
Parameter Format	<nr2>
Example	SYST:AIO:IN1:CAL:OFF 0.01
Query Format	SYSTem:AIO:INput[n]:CALibration:OFFset? Returns calibration coefficient
Returned Data Format	<nr2>
Query Example	SYST:AIO:IN1:CAL:OFF? 0.010
Query Command	SYSTem:AIO:INput[n]:CALibration:OFFset:DEFault? Returns default calibration coefficient value
Returned Data Format	<nr2>
Query Example	SYST:AIO:IN1:CAL:OFF:DEF? 1.000
Query Command	SYSTem:AIO:INput[n]:CALibration:OFFset:MAXimum? Returns upper limit of calibration coefficient value
Returned Data Format	<nr2>
Query Example	SYST:AIO:IN1:CAL:OFF:MAX? 1.000

Query Command	SYSTem:AIO:INput[n]:CALibration:OFFset:MINimum? Returns lower limit of calibration coefficient value
Returned Data Format	<nr2>
Query Example	SYST:AIO:IN1:CAL:OFF:MIN? 1.000

8.12.4.2 SYSTem:AIO:OUTput#:CALibration

Command Syntax	SYSTem:AIO:OUTput[n]:CALibration:GAIN <nr2>
Description	Calibrates the full scale gain of the AZX parameter controlled by the analog output.
Parameters	Reference
Parameter Format	<nr2>
Example	SYST:AIO:OUT1:CAL:GAIN 100.0
Query Format	SYSTem:AIO:OUTput[n]:CALibration:GAIN? Returns calibration coefficient
Returned Data Format	<nr2>
Query Example	SYST:AIO:OUT1:CAL:GAIN? 1.000

Query Command	SYSTem:AIO:OUTput[n]:CALibration:GAIN:DEFault? Returns default calibration coefficient value
Returned Data Format	<nr2>
Query Example	SYST:AIO:OUT1:CAL:GAIN:DEF? 1.000

Query Command	SYSTem:AIO:OUTput[n]:CALibration:GAIN:MAXimum? Returns upper limit of calibration coefficient value
Returned Data Format	<nr2>
Query Example	SYST:AIO:OUT1:CAL:GAIN:MAX? 1.000

Query Command	SYSTem:AIO:OUTput[n]:CALibration:GAIN:MINimum? Returns lower limit of calibration coefficient value
Returned Data Format	<nr2>
Query Example	SYST:AIO:OUT1:CAL:GAIN:MIN? 0.000

Command Syntax	SYSTem:AIO:OUTput[n]:CALibration:OFFset <nr2>
Description	Calibrates the full scale gain of the AZX parameter controlled by the analog output.
Parameters	Reference
Parameter Format	<nr2>
Example	SYST:AIO:OUT1:CAL:OFF 0.01
Query Format	SYSTem:AIO:OUTput[n]:CALibration:OFFset?
	Returns calibration coefficient
Returned Data Format	<nr2>
Query Example	SYST:AIO:OUT1:CAL:OFF? 0.010
Query Command	SYSTem:AIO:OUTput[n]:CALibration:OFFset:DEFault?
	Returns default calibration coefficient value
Returned Data Format	<nr2>
Query Example	SYST:AIO:OUT1:CAL:OFF:DEF? 1.000
Query Command	SYSTem:AIO:OUTput[n]:CALibration:OFFset:MAXimum?
	Returns upper limit of calibration coefficient value
Returned Data Format	<nr2>
Query Example	SYST:AIO:OUT1:CAL:OFF:MAX? 1.000
Query Command	SYSTem:AIO:OUTput[n]:CALibration:OFFset:MINimum?
	Returns lower limit of calibration coefficient value
Returned Data Format	<nr2>
Query Example	SYST:AIO:OUT1:CAL:OFF:MIN? 1.000

8.13 Test Sequence Commands

The following SCPI commands are available to control Power source embedded Test Sequence operation from an user ATE test program. **Note** that the Test Sequence functionality requires power source firmware revision 3.7.0 or higher.

Command Syntax Description	TSEquence:CATalog? Returns a comma-separated list of available sequences files. The query can be customized with the type of memory, OFFSET to determine start index, and LENGTH to define the number of results. <OPT: MEMORY, OPT: OFFSET, OPT: LENGTH>
Parameters	Memory types: INTERNAL RAM INTERNAL = Internal Flash Memory. (Default selection) RAM = Internal RAM. Content will be lost when power source is turned off.
Parameter Format	<cr>, <nr1>, <nr1>
Returned Data Format	<cr>
Example	TSEQ:CAT? 1,"4-11-Dips-Class2-Test.7z",2,"4-11-Dips-Class3-Test.7z",3,"4-11-Short-Interruptions-Test.7z",4,"4-11-Vars-Test.7z" TSEQ:CAT? RAM 1,"TestExample.7z" TSEQ:CAT? INTERNAL, 3, 4 3,"4-11-Short-Interruptions-Test.7z",4,"4-11-Vars-Test.7z"
Command Syntax Description Parameters	TSEquence:SElect This command selects a sequence file by name or number. <REQ: FILE STRING FILE NUMBER, OPT: MEMORY> Memory types: INTERNAL RAM INTERNAL = Internal Flash Memory. (Default selection) RAM = Internal RAM. Content will be lost when power source is turned off.
Parameter Format	<cr> or <nr1>, <cr>
Example	TSEQ:SEL "TestExample.7z", RAM TSEQ:SEL 3, INTERNAL TSEQ:SEL 1
Query Format Returned Data Format Query Example	TSEquence:SElected? <cr> TSEQ:SEL? "4-11-Short-Interruptions-Test"
Command Syntax Description Parameters	TSEquence:CONTRol This command controls sequence execution <RUN PAUSE STOP STEP REStart PASS FAIL CLEAR> RUN: to start the execution from the last selected step PAUSE: to pause the execution, only available when the sequence state is running. STOP: to stop the execution. STEP: to execute only the selected step. REST: to restart all progress and test execution.

	<p>PASS: to pass the current step in execution.</p> <p>FAIL: to fail the current step in execution and stop the sequence progress.</p> <p>CLEAR: to clear all logs and remove currently selected sequence from the execution panel.</p>
Parameter Format Example	<p><cr></p> <p>TSEQ:CON RUN</p> <p>TSEQ:CON PASS</p> <p>TSEQ:CON CLEAR</p>
Command Syntax Description	<p>TSEquence:STATUS?</p> <p>This command returns sequence execution status, where:</p> <p>NUMBER: <nr1>. Current step number. Example: 1</p> <p>PROGRESS: <nr1>. Current step progress. <0> to <100></p> <p>STATUS: <cr>. Current state of the step execution:</p> <p>"0-SKIPPED"</p> <p>"1-PASSED"</p> <p>"2-FAILED"</p> <p>"3-STOPPED"</p> <p>"4-RUNNING"</p> <p>"5-PAUSED"</p> <p>DESCRIPTION: <cr>. Current step description. Example: "User Input"</p> <p>INSTRUCTION: <cr>. Returns TRUE if there is pending user input.</p> <p>Note: When an instruction is pending, some commands will not be available, for example: TSEQ:STEP:GOTO or TSEQ:CON RUN</p>
Parameters	None
Returned Data Format Query Example	<p><cr></p> <p>TSEQ:STAT?</p> <p>NUMBER,1,PROGRESS,0,STATUS,"4-RUNNING",DESCRIPTION,"Configuration",INSTRUCTION,TRUE</p>
Command Syntax Description	<p>TSEquence:Input</p> <p>This command allows to enter the necessary parameter when the instruction status is pending (INSTRUCTION, TRUE).</p>
Parameters	<p><REQ: VARIABLE STRING INPUT NUMBER, REQ: VALUE STRING></p> <p>Where input number is the index obtained using TSEQ:IN?. In addition, it is possible to enter each entry with its respective variable name.</p>
Parameter Format Example	<p><cr> or <nr1>, <cr></p> <p>TSEQ:IN "IEC61000_4_11_UUT_SN", "00024"</p> <p>TSEQ:IN "IEC61000_4_11_COMPANY", "PPST"</p> <p>TSEQ:IN 3, "PPST"</p>
Query Format	<p>TSEquence:INput?</p>
Returned Data Format Query Example	<p><cr></p> <p>TSEQ:IN?</p> <p>1,INPUT,"UUT Part Number",VARIABLE,"IEC61000_4_11_UUT_PN",VALUE,"1",2,INPUT,"UUT Serial Number",VARIABLE,"IEC61000_4_11_UUT_SN",VALUE,"00024",3,INPU</p>

T,"Company
 Name",VARIABLE,"IEC61000_4_11_COMPANY",VALUE,"",4,INPUT,"Tes
 t Operator",VARIABLE,"IEC61000_4_11_TECH",VALUE,"",5,INPUT,"UUT
 Mode of
 Operation",VARIABLE,"IEC61000_4_11_UUT_OP_MODE",VALUE,""

Command Syntax	TSEquence:RESULT?
Description	Returns a comma-separated list of all steps in the sequence with their respective status.
Parameters	None
Parameter Format	n/a
Returned Data Format	<cr>
Example	TSEQ:RES? 1,PASSED,2,PASSED,3,SKIPPED,4,STOPPED,5,-,6,-,7,-,8,-,9,-,10,-,11,- ,12,-,13,-,14,-,15,-,16,-,17,-,18,-,19,-,20,-,21,-,22,-,23,-,24,-,25,-

Command Syntax	TSEquence:STEP:GOTO
Description	This command moves the execution cursor to the argument of the element passed.
Parameters	<REQ: STEP NUMBER>
Parameter Format	<nr1>
Returned Data Format	n/a
Query Example	TSEQ:STEP:GOTO 1 TSEQ:STEP:GOTO 3 TSEQ:STEP:GOTO 10

8.14 IEEE488.2 Common Commands

The following IEEE488.2 common commands (a.k.a. star commands) are supported by the AC power source. These commands are provided for compatibility with the IEEE488.2 standard. They are aliases to the relevant proprietary command and can be used interchangeably. Commands are shown in alphabetical order.

IEEE488.2 Command	Description	Group	Mandatory
*CLS	Clear Status	Status and Event	Yes
*DCL	Device Clear	Internal Operations	
*ESE <n>	Event Status Register Enable	Status and Event	Yes
*ESE?	ESE Query	Status and Event	Yes
*ESR?	Event Status Register Query	Status and Event	Yes
*GTL	Goto Local	Control	
*IDN?	Identify	System Data	Yes
*LLO	Local Lock Out	Control	Yes
*OPC	Operation Complete	Synchronization	Yes
*OPC?	OPC Status Query	Synchronization	Yes
*RST	Reset	Internal Operations	Yes
*SRE	Service Request Enable	Status and Event	Yes
*SRE?	SRE Query	Status and Event	Yes
*STB?	Status Byte Query	Status and Event	Yes
*TRG	Trigger	Synchronization	
*WAI	Wait	Synchronization	Yes

Table 8-3: Mandatory IEEE488.2 Common Commands

Command Syntax
Description

***CLS**

Clear Status. The Clear Status (CLS) command clears the status byte by emptying the error queue and clearing all the event registers including the Data Questionable Event Register, the Standard Event Status Register, the Standard Operation Status Register and any other registers that are summarized in the status byte.

Command Syntax
Description
Parameters
Parameter Format

***DCL**

Device Clear. Resets the instrument to a default state.
None
n/a

Command Syntax Description	*ESE<nr1> Selects the desired bits from the standard event status enable register. The variable <nr1> represents the sum of the bits that will be enabled. This register monitors I/O errors and synchronization conditions such as operation complete, request control, query error, device dependent error, status execution error, command error and power on. The selected bits are OR'd to become a summary bit (bit 5) in the byte register which can be queried. The setting by this command is not affected by *RST. However, cycling the power will reset this register to zero. Refer to section 8.12 for register bit values.
Parameters Parameter Format Example Query Format Returned Data Format Query Example	Range 0-255 <nr1> *ESE 128 *ESE? <nr1> *ESE? 193
Query Format Description	*ESR? Event Status Register Query. Reads the contents of the Status Event Register (ESR). After this query, the content of the ESR register is reset. Refer to section 8.12 for register bit values.
Returned Data Format Query Example	<nr1> *ESR? 0
Command Syntax Description Returned Data Format Query Example	*GTL Goto Local. Releases lock of front panel controls. N/A N/A
Query Format Description	*IDN? Identification Query. Returns the unit's Identity string. The IDN string response contains several fields separated by a comma. <i>Query response:</i> Manufacturer, model incl. Vac input configuration and any installed options, serial number, firmware revision.
Returned Data Format Query Example	<cr>,<cr>,<nr1>,<nr2> *IDN? PPSC,3550AZX-8CL,106378889,2.0.0
Command Syntax Description Parameters Parameter Format	*LLO Local Lock out. Locks out front panel LOCAL function. None n/a

Command Syntax Description	*OPC The Operation Complete (OPC) command sets bit 0 in the Standard Event Status Register when all pending operations have finished.																				
Parameters Example Query Format Description	Optional: < BLOCK 0 NOBLOCK 1> *OPC *OPC? < BLOCK 0 NOBLOCK 1> IEEE488.2 standard command. The parameter is optional. The argument is optional, if it is not sent: <ul style="list-style-type: none"> • In UPC compatible mode default argument will be NONBLOCK or 1. • In normal mode default argument will be BLOCK or 0. 																				
Returned Data Format Query Example	*OPC? BLOCK 0 Returns 1 when all pending overlapped operations have been completed. It can be used to cause the controller to wait for commands to complete. *OPC? NOBLOCK 1 Returns 1 if all pending overlapped operations have been completed or 0 if there are pending overlapped operations. It will not cause the controller to wait for commands to complete. Pending overlapped operations can be a transient or a soft start using ramp time/slew rates.																				
Command Syntax Description	*RST RESET. The *RST command (reset) has the same effect as an IEEE-488 Device Clear bus command but can be used over the RS232C, USB or LAN interface as well. This command resets the unit to its power on default state. User defined waveforms or programs are not erased but the mode is set to manual and the transient list table is cleared. (Unless there is a power-on program configured using the [SOURCE:]INITIAL command) <i>Note: A reset cycle of the power source can take up to 30 seconds to complete. When developing test programs, allow this time to pass before sending other commands. Adjust interface time-out settings as needed.</i>																				
Parameters Parameter Format RESET STATE	None n/a <table border="0"> <tr> <td>FORM</td> <td>3</td> <td>VOLT:MODE</td> <td>AC</td> </tr> <tr> <td>VOLT:AC</td> <td>0.0000</td> <td>COUPLING</td> <td>DC</td> </tr> <tr> <td>VOLT:DC</td> <td>0.0000</td> <td>RANGE</td> <td>AC</td> </tr> <tr> <td>CURR:AC</td> <td>41.6667</td> <td></td> <td></td> </tr> <tr> <td>CURR:DC</td> <td>20.8333</td> <td></td> <td></td> </tr> </table>	FORM	3	VOLT:MODE	AC	VOLT:AC	0.0000	COUPLING	DC	VOLT:DC	0.0000	RANGE	AC	CURR:AC	41.6667			CURR:DC	20.8333		
FORM	3	VOLT:MODE	AC																		
VOLT:AC	0.0000	COUPLING	DC																		
VOLT:DC	0.0000	RANGE	AC																		
CURR:AC	41.6667																				
CURR:DC	20.8333																				

Command Syntax	*SRE <nr1>
Description	Before reading a status register, bits must be enabled. This command enables bits in the service request register. The current setting is saved in non-volatile memory.
Parameters	0-255
Parameter Format	<nr1>
Example	*SRE 255
Query Format	*SRE?
Description	Reads the current state of the service request enable register. The register is cleared after reading it. Refer to section 8.12 for register bit values.
Returned Data Format	<nr1>
Query Example	*SRE? 255
Query Format	*STB?
Description	Status Byte Query. The *STB? query returns the contents of the status byte register (STB). After this query, the content of the STB register is reset. Refer to section 8.12 for register bit values.
Returned Data Format	<nr1>
Query Example	*STB? 4
Command Syntax	*TRG
Description	Triggers pending operation.
Parameters	None
Parameter Format	n/a
Command Syntax	*WAI
Description	Prohibits the instrument from executing any new commands until all pending overlapped commands have been completed.
Parameters	None
Parameter Format	n/a

8.15 Status and Events Registers

The IEEE488.2 standard defines a standardized status and events register system. Refer to the ANSI/IEEE-488.2 1987 standard for more information. This section provides an overview of these registers and bit positions for various status and error events.

8.15.1 Status Byte Register (STB)

The status register content is returned on a *STB? query. It contains 8 bits as shown in the table below. The return value represents the 8 bits positions and can range from 0-255. A *CLS command will clear the Status Byte Register (STB) and the Event Status Register (ESR). Refer to Figure 8-1, "Status Byte Logical Model".

BIT	NAME	DEFINITION
7	SOS	:STATus:OPERation register bit summary
6	MSS/RQS	- MASTER SUMMARY summarizes all STATUS BYTE bits (except bit 6) for *STB?, or, - REQUEST SERVICE indicates this device requested service when a Serial Poll was performed.
5	ESB	STANDARD EVENT STATUS REGISTER bit summary
4	MAV	MESSAGE AVAILABLE indicates Query response data is available
3	SQS	:STATus:QUESTionable register bit summary
2	EEQ	ERROR/EVENT QUEUE indicates an SCPI Error/Event message is available
1	BUSY	indicates UPC front panel not in V/I mode
0	FAULT	indicates Power Source FAULT

Table 8-4: Status Byte Register (STB)

Note: Setting a SERVICE REQUEST ENABLE (SRE) bit true unmask the STATUS bit in the STB. Bit 6 of the SRE is not applicable as the MASTER SUMMARY bit of the STB cannot be masked. The STB, SRE, ESR and ESE registers are 8 bits each.

The status byte logical model is shown in the figure below.

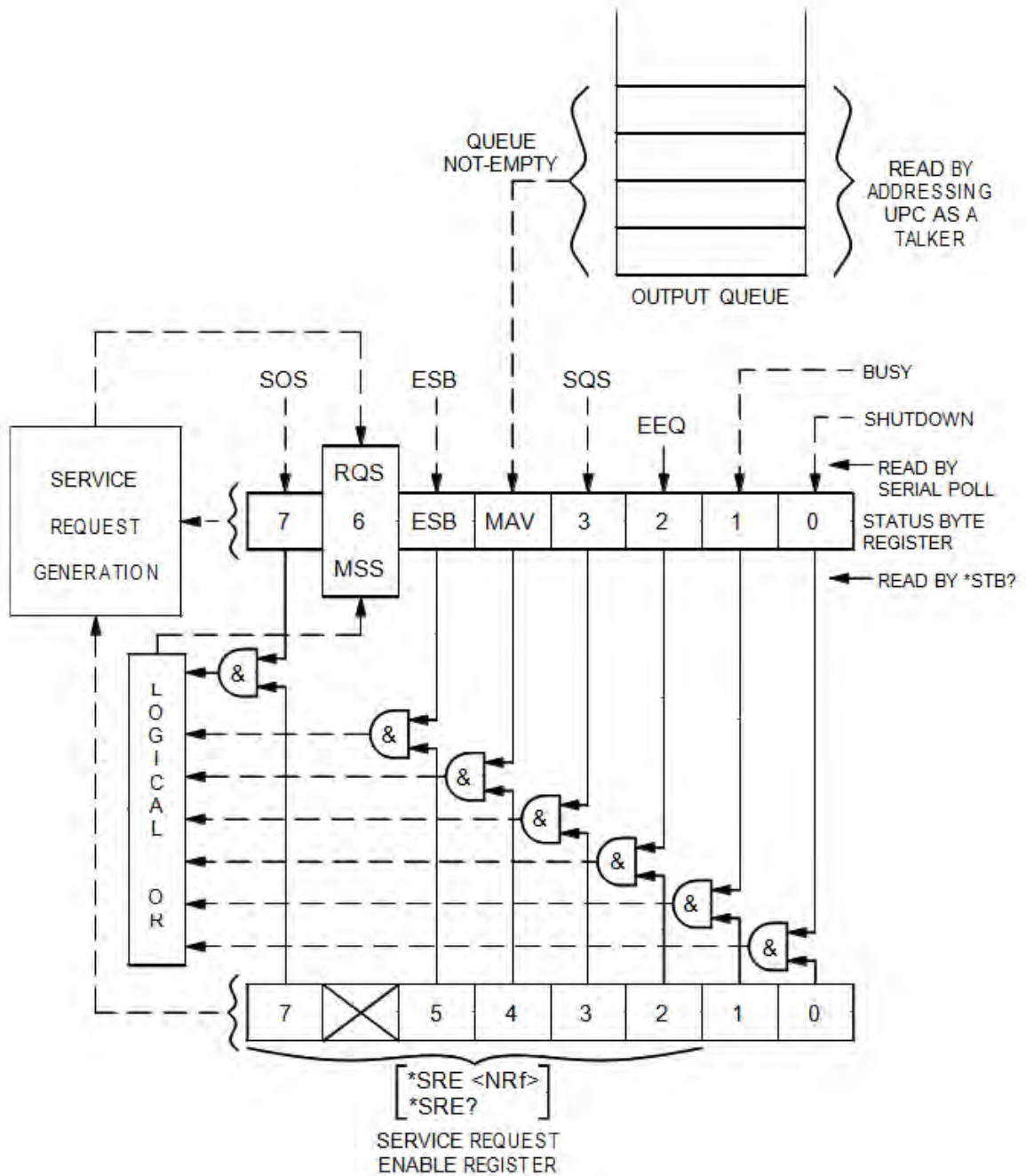

Figure 8-2: Status Byte Logical Model

8.15.2 Status Event Register (ESR)

Events reported by the STANDARD EVENT STATUS register may be queried via the *ESR? command. Reading the ESR register clears it. The EVENT STATUS summary bit in the STATUS BYTE (STB) will be set when an unmasked EVENT STATUS bit goes true.

BIT	NAME	DEFINITION
7	PON	POWER ON indicates Input power was just applied
6	URQ	USER REQUEST indicates "LOCAL" key was just pressed
5	CME	COMMAND ERROR indicates invalid command or query received
4	EXE	EXECUTION ERROR indicates can't execute command with data received
3	DDE	DEVICE DEPENDANT ERROR indicates UPC not properly configured
2	QYE	QUERY ERROR indicates cannot respond with data
1	RQC	REQUEST CONTROL - not used
0	OPC	OPERATION COMPLETE indicates previous operation complete

Table 8-5: Status Event Register (ESR)

Setting an EVENT STATUS ENABLE (ESE) bit true unmask the EVENT bit in the ESR. Also see :SYSTEM:ERROR? query for relevant information.

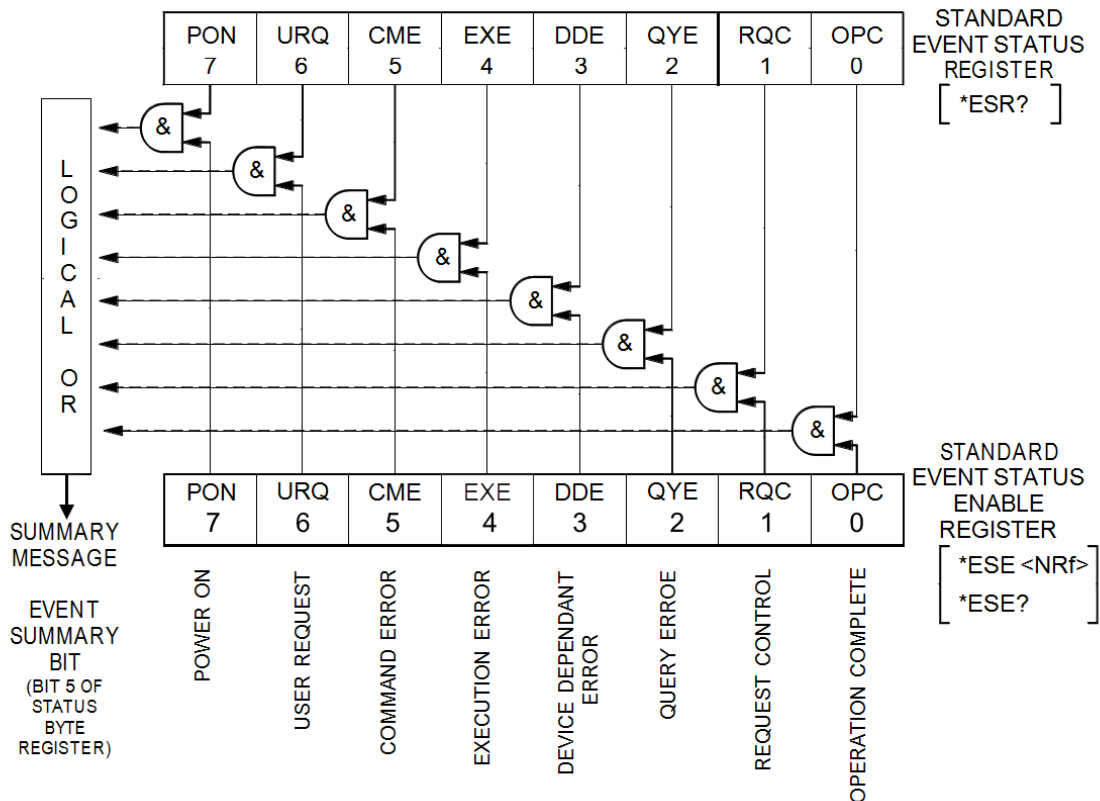

Figure 8-3: Standard Event Register (ESR) Model

8.15.3 SCPI Status Registers

The STATUS:OPERation and STATUS:QUESTIONable registers provide information about the present mode of operation.

- Transition of a CONDITION bit to the true state causes the EVENT bit to be set true.
- Unmasked ENABLE bits allow an EVENT bit to be reported in the summary bit for that EVENT register in the STATUS BYTE register.
- Setting an ENABLE bit true, un masks the corresponding EVENT bit.
- Reading an EVENT register clears it.
- All :STATUS registers are 16 bits (Figure 5.3).

The STATUS:OPERation register provides information about the present mode of operation.

Relevant commands for the STATUS:OPERation register are:

:STATUS:OPERation:CONDition?

:STATUS:OPERation:ENABle

:STATUS:OPERation:ENABle?

:STATUS:OPERation:EVENT?

The STATUS:QUESTIONABLE register provides information about errors and questionable measurements.

Relevant commands for the STATUS:QUESTIONABLE register are:

:STATUS:QUESTIONable:CONDition?

:STATUS:QUESTIONable:ENABle

:STATUS:QUESTIONable:ENABle?

:STATUS:QUESTIONable:EVENT?

Refer to Figure 8-3, “SCPI Status Registers Model” for details on registers.

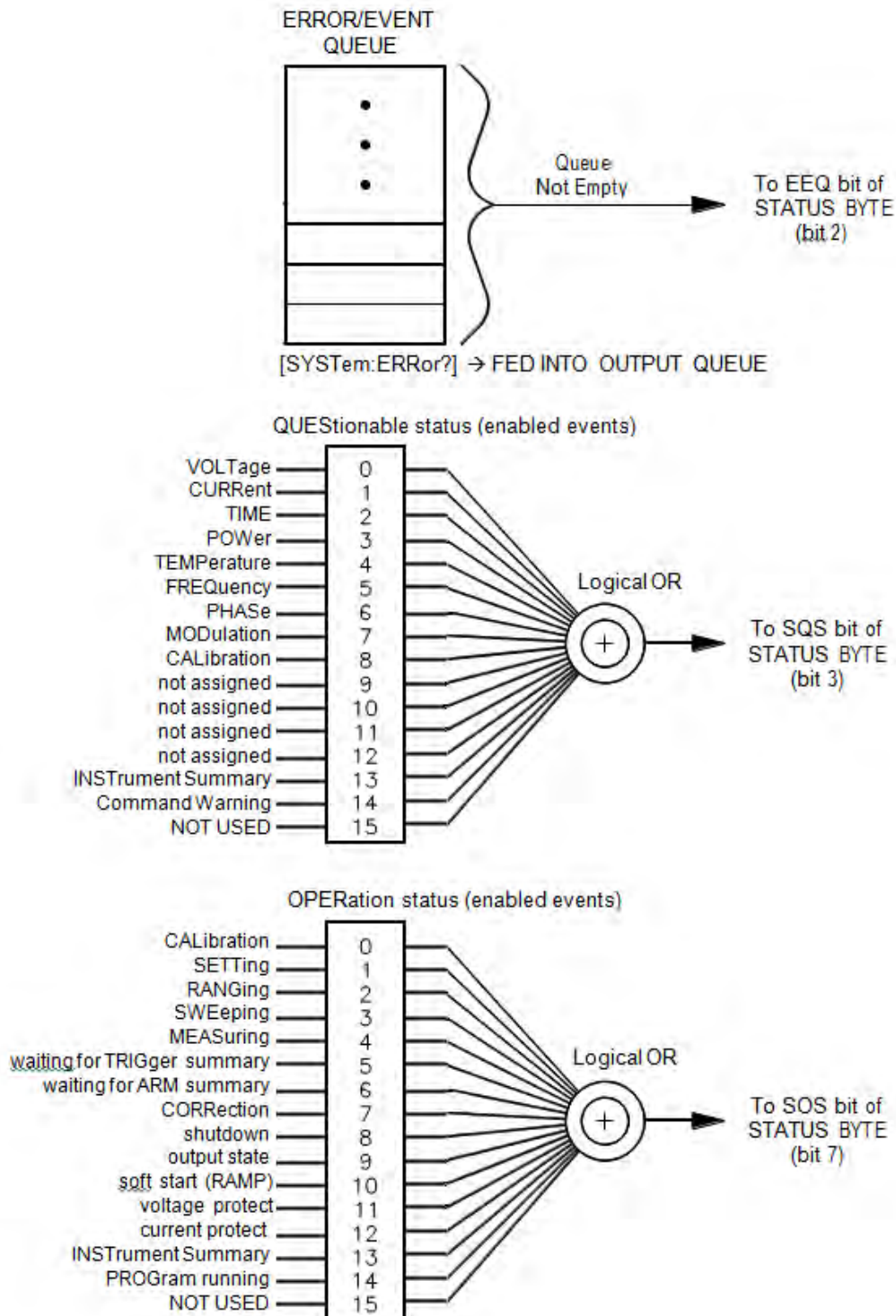

Figure 8-4: SCPI Status Registers Model

9 USB Driver Installation

9.1 Overview

The USB interface provides a virtual COM port for the PC. Via this port, the unit can be controlled as a normal RS232 interface, e. g. with a terminal program or user application program. There are two drivers provided with the AZX units:

- Virtual COM driver** This allows communication with the power sources using a virtual serial port (COMx).
- Network Driver** This allows communication with the power source using a virtual IP address. Using this driver, all built-in web server functions are available via USB using a browser.

9.2 Installation

USB drivers are stored in the AZX controller and installed when the unit is first connected to a Windows PC. Proceed as follows:

1. With the AZX unit powered up, connect a USB cable between the AZX USB Device port on the rear panel and an available USB port on a Windows PC.
2. Once plugged it, the PC should detect the present of the AZX. If this is the first time you connect to this PC, the drivers must be installed. This process should run automatically but if for some reason it does not, follow the subsequent steps.
3. On the drive popup shown below, select the “Open folder to view files” entry.

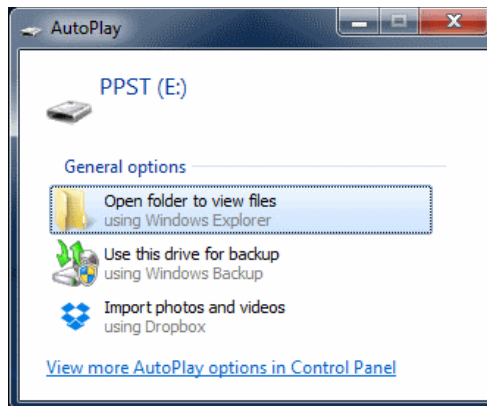

4. The directories shown below will be visible. Select the “drivers” directory

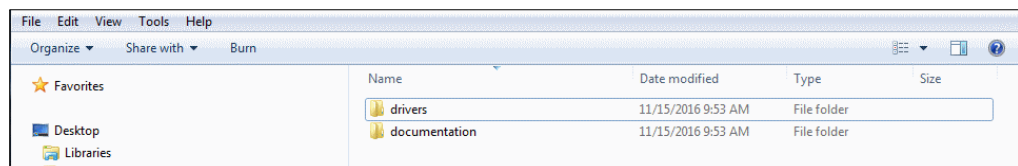

5. Next, select the “Windows” directory

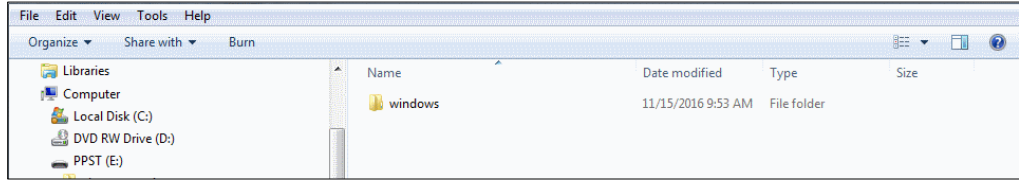

6. Run the “Driver_Installer.exe” located in this directory as shown below.,

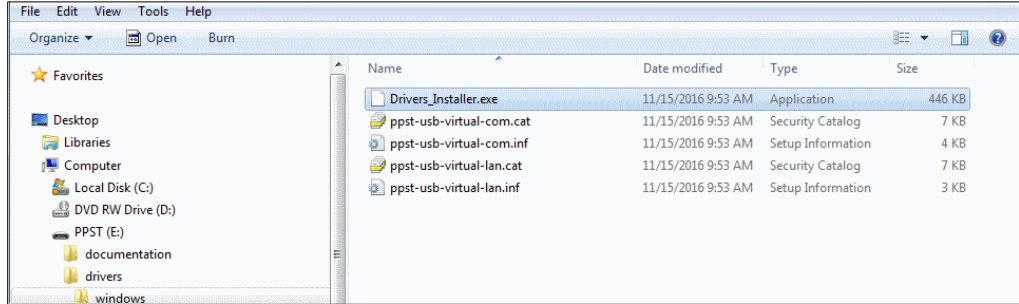

7. Allow the installation to complete.

At the end of this process, you should be able to see the two PPST USB drivers in the Windows Device Manager window under “Network Adaptors” and “Ports (COM & LPT)” respectively. The USB interface is now ready for use.

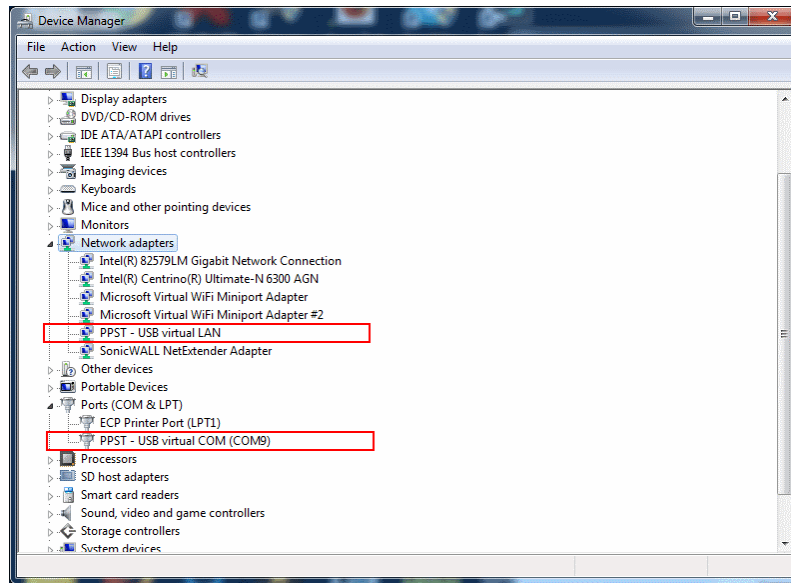

Figure 9-1: PPST USB Drivers visible in Windows Device Manager

10 LAN Interface Configuration

10.1 Overview

All AZX models are equipped with a LAN (Ethernet) interface. As shipped, the unit automatically obtains an IP address from the network using the DHCP protocol. If the instrument is turned off for long periods, the IP address lease may expire and a new IP address will be assigned. If this is the case, it is possible to assign a fixed IP address instead.

10.2 Web Browser Interface

The AZX Series® conforms to the LXI (Lan eXtensions for Instrumentation) standard and as such as a built in web server. This allows communication with the AZX from any web browser as long as the AZX is on the same network.

Note: The AZX web server has been tested with Google Chrome and Mozilla Firefox browsers only. Microsoft Internet Explorer is now obsolete and is not supported. Other browser like Edge or Safari may not fully operate or display information correctly.

Note: Web server use from a browser is **not** supported in *UPC Compatibility* mode. Disable this mode when operating the AZX from a web browser.

Use the IP address shown in the LAN INTERFACE SETUP screen under the SYSTEM key to determine the IP address to type into the web browser.

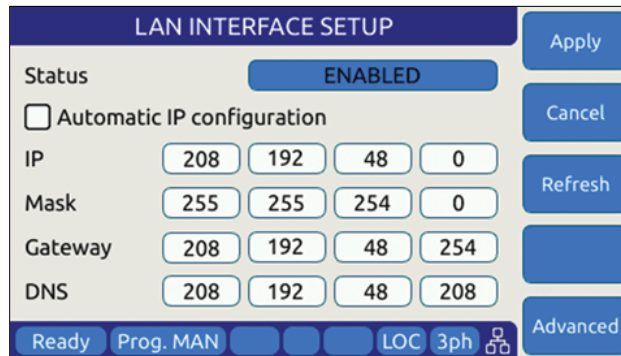

LAN INTERFACE SETUP					
Status	ENABLED				Apply
<input type="checkbox"/> Automatic IP configuration					Cancel
IP	208	192	48	0	Refresh
Mask	255	255	254	0	
Gateway	208	192	48	254	
DNS	208	192	48	208	
Ready Prog. MAN [] [] [] [] LOC 3ph [] []					Advanced



CAUTION: BEFORE USING BROWSER CONTROL

Verify that the level of remote access control is appropriate for the situation at hand. The power source is capable of producing lethal output voltage and operating it without being physically in the same room or space present a safety risks to others. Refer to 10.3.2, “**Front Panel Access Control**”.

If the unit is on the same network or reachable through the internet, the home screen of the AZX web server will appear.

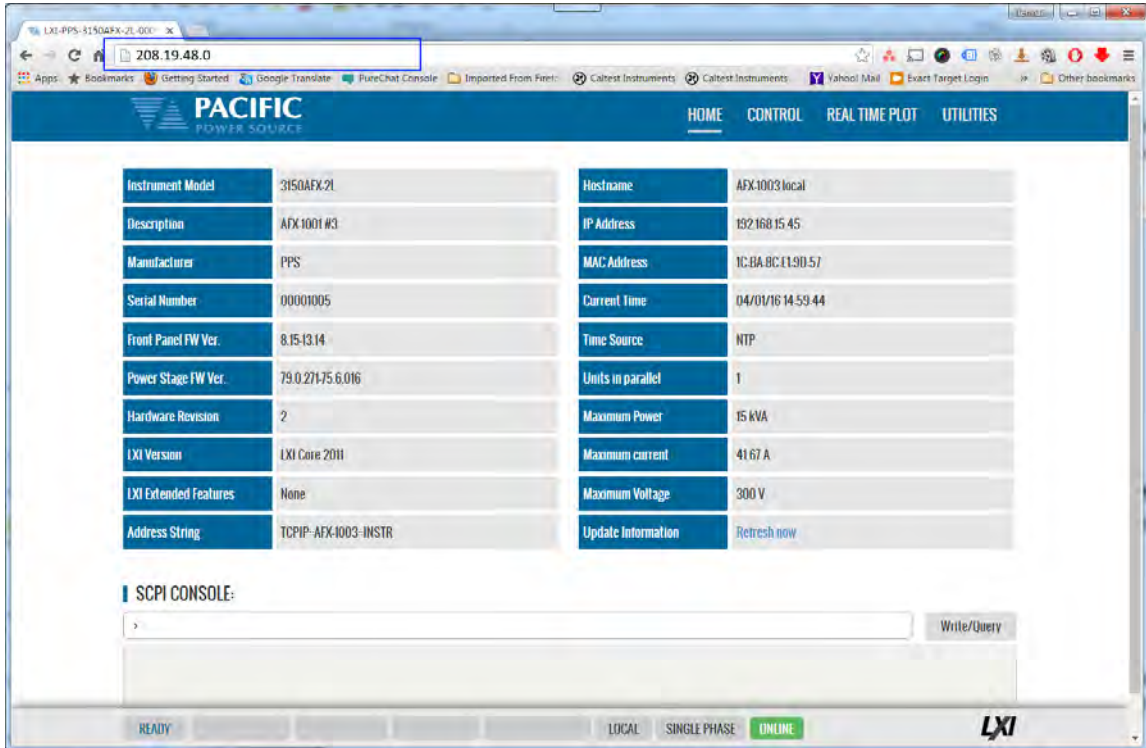

Figure 10-1: LXI Web Server Home Screen

When permitted, the browser interface allows monitoring of measurements and/or full control of the power source. If the operator is not near the actual instruments being controlled, care must be taken to the appropriate access control limits.

10.3 Access Control

Since the power source is capable of producing hazardous voltages at its output terminals, remote operation of the product over a LAN connection or any other available remote control interface can be restricted by the user to include only monitoring functions rather than full programming controls.

This feature is provided to ensure the safety of anyone near the unit in its actual physical location. This access control mechanism requires granting specific access to certain functions and features from the front panel by a person present at the location of the power source and requesting permission first trying to access a unit remotely.

These access control functions can be set from the SYSTEM Menu, INTERFACE screen or via the webserver using any browser.



WARNING

All AZX Units are shipped from the factory with ACCESS CONTROL **DISABLED**. It is the instrument's owner's responsibility to enable these features.

10.3.1 Browser Access Control

When connecting to the power source via a browser on which access has been restricted, the following message will appear:

The browser Access dialog is shown below.

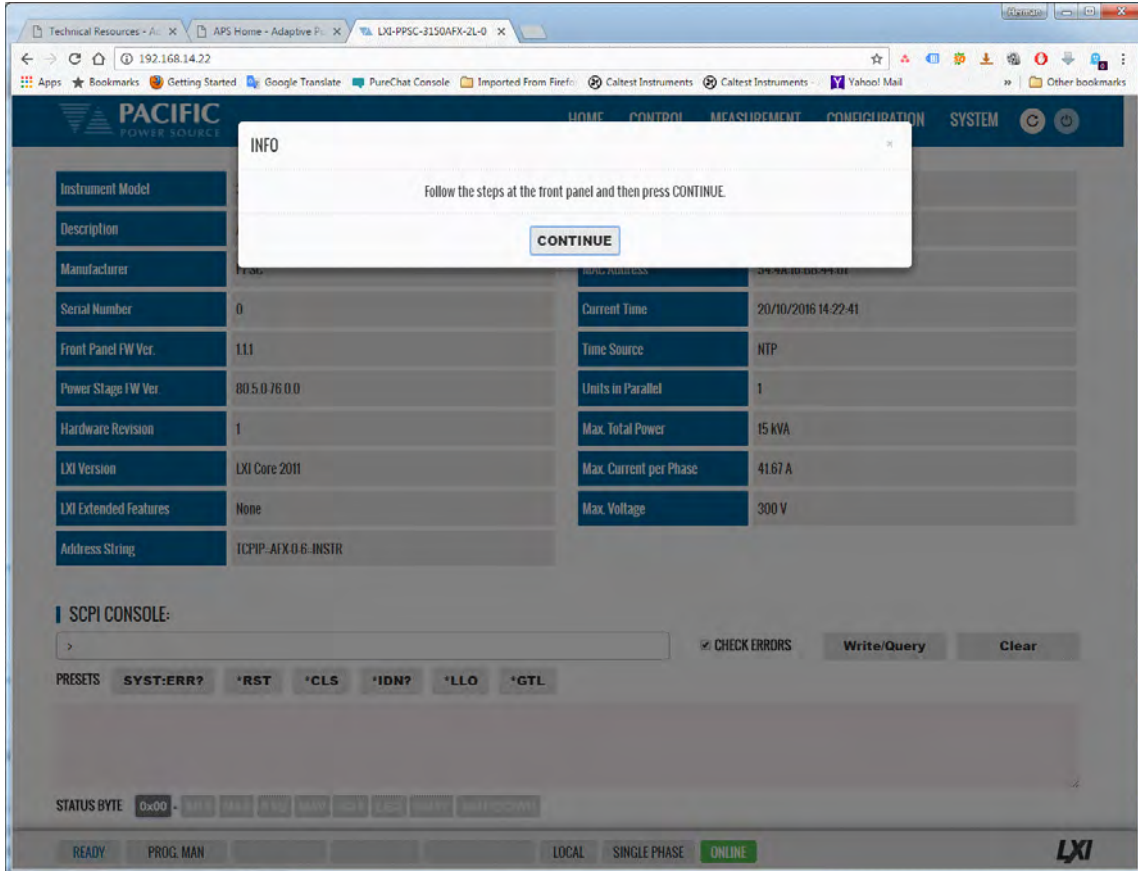

Figure 10-2: ACCESS CONTROL Dialog Screen

If the operator knows the four-digit access password that was set on the actual unit, he can enter the password code and gain either full control of the source or Monitor⁴ only access depending on which mode was selected.

If the operator does not know the password, he can request access. Such a request can only be granted by a person who is in front of the actual unit however. This prevents unauthorized access from a remote location and protects the local user from possible harm. An Access Request will result in a Pop-Up message on the power source LCD screen.

The access control password can be set/changed only by the person(s) present at the physical location of the unit. Factory default password is “1234” but it is strongly **advised** the end user changes this to his own code after receipt of the unit.

If access is denied, the browser interface will enter MONITOR only mode in which measurements and settings can be viewed remotely but control is possible. When in this mode, a user with knowledge of the access password can enter FULL CONTROL mode by supplying the

⁴ Note: Monitor Only access mode requires firmware revision 3.6.44 or higher.

correct password or request full access from a local operator that is present at the unit’s location.

This dialog will appear when opening the browser interface while a unit is under ACCESS CONTROL and MONITOR mode is OFF (disabled).

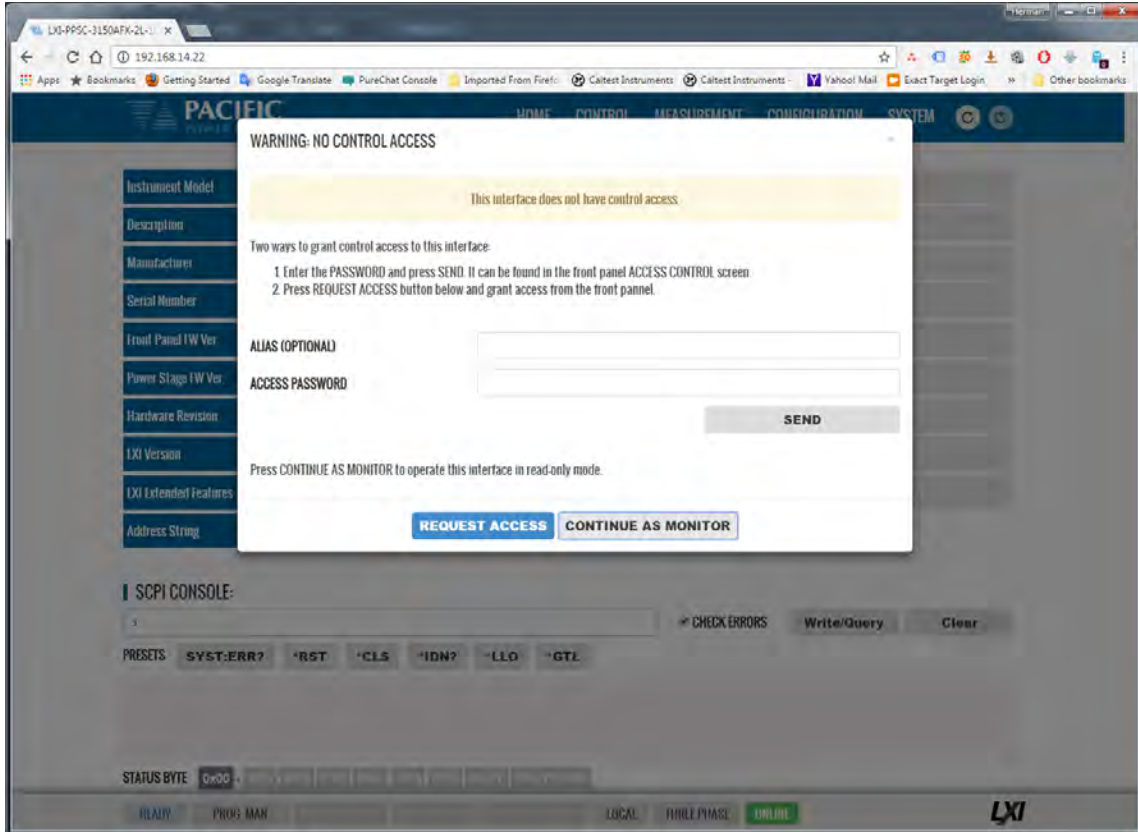

Clicking on “REQUEST ACCESS” will result in a dialog box appearing on the unit’s LCD screen displaying the requestor’s IP address. A message on the browser will indicate action is needed by the local operator. Now, the local operator can either DENY or GRANT access.

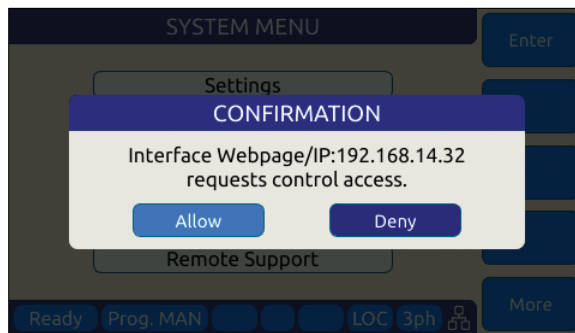
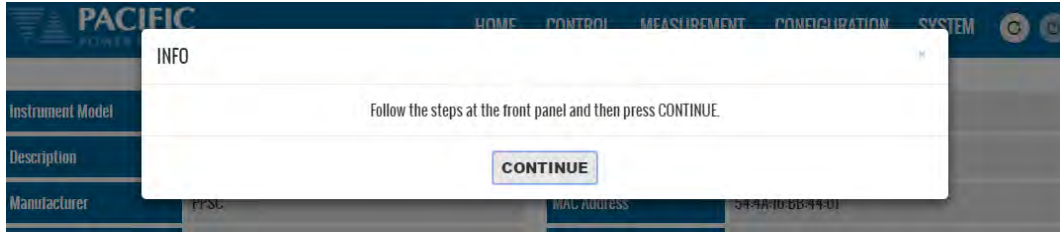

Figure 10-3: Remote Access Control Request Dialog

If remote access is granted, full control is provided. If denied, only monitoring is available.

Note: If the remote operator was given the ACCESS passcode, he can use it to gain access without a local operator’s intervention.



When granted, the requestor’s IP address will be added to the whitelist IP. The operator can remove any of the white listed IP address at any time if needed. This will lock out remote access for that PC until access is re-granted anew.

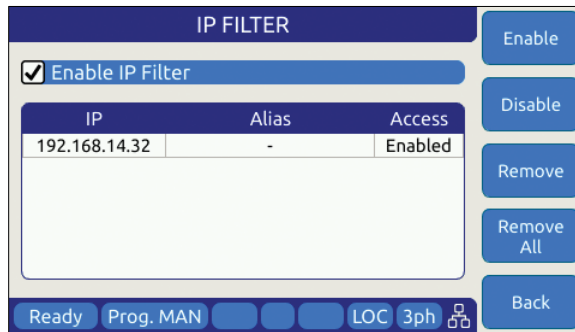
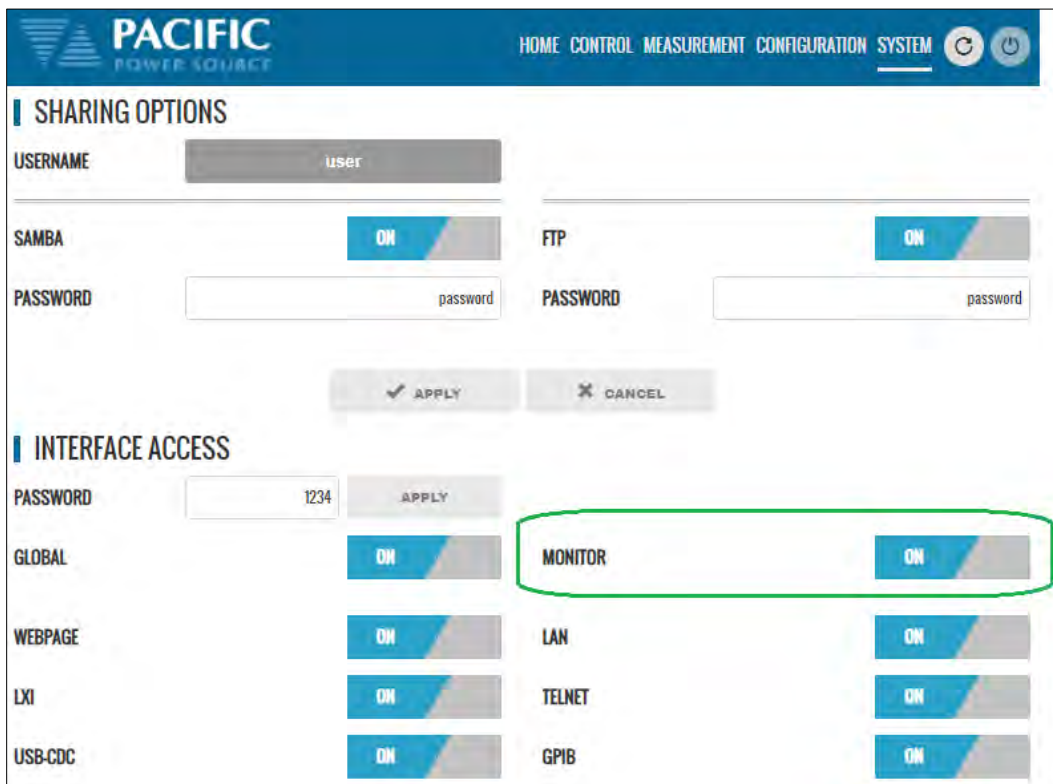
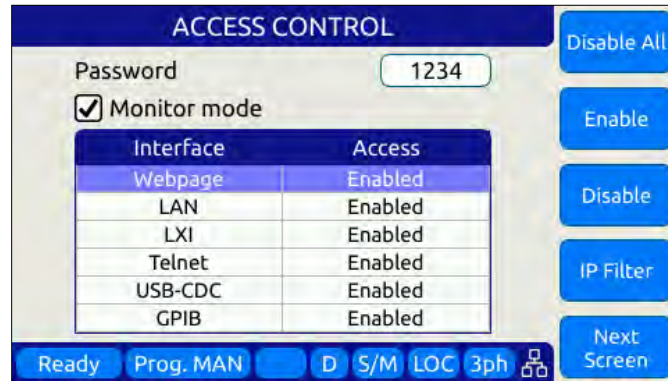

Figure 10-4: Remote Access Control IP Filter screen

Remote acces can be configured from the System menu. To enable Monitor only mode, turn MONITOR on as shown below. In this mode, settings and measurements can be viewed but no changes can be mode remotely.



Monitor mode can also be selected from the front panel using the System, Access Control screen as shown below.



If Monitor mode is disabled, the browser access control screen will look like this.

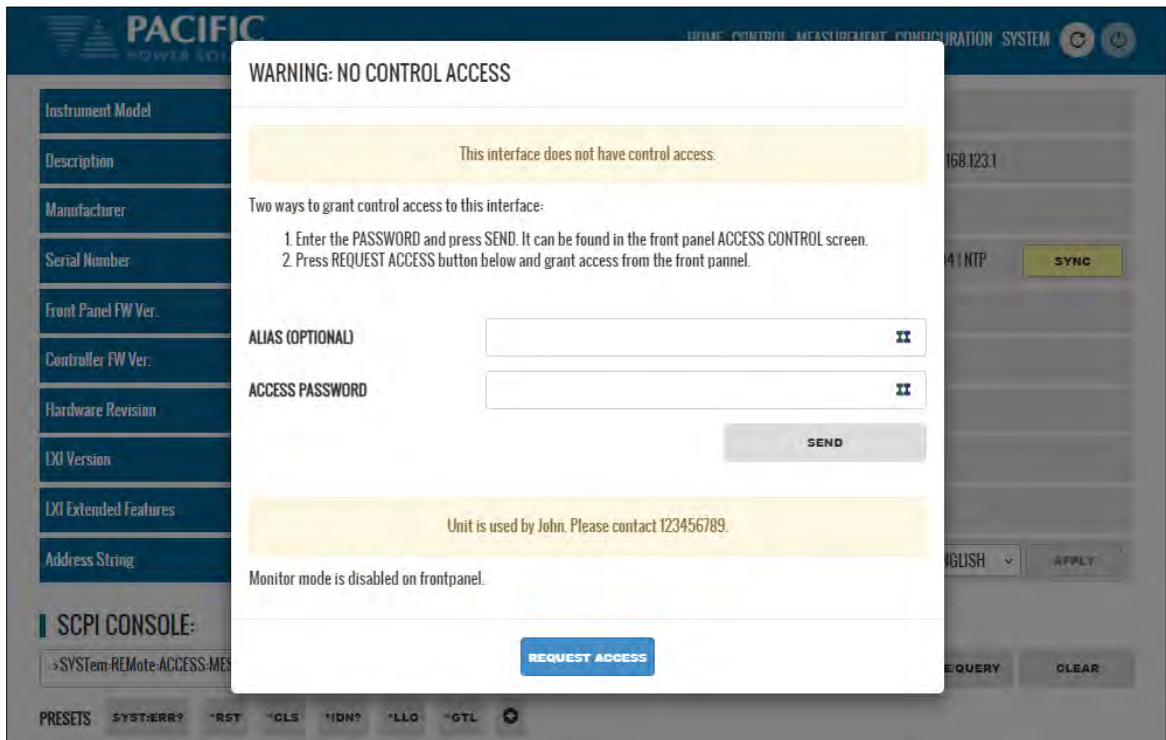

The message at the bottom of the screen can be set by the main user with the `SYSTEM:REMOte:ACCESS:MESSage` SCPI command. In this example, the following command was used:
`SYSTEM:REMOte:ACCESS:MESSage "Unit is used by John. Please contact 123456789."`

10.3.2 Front Panel Access Control

Setting remote control access levels and interface types is accomplished from the SYSTEM menu under Interfaces.

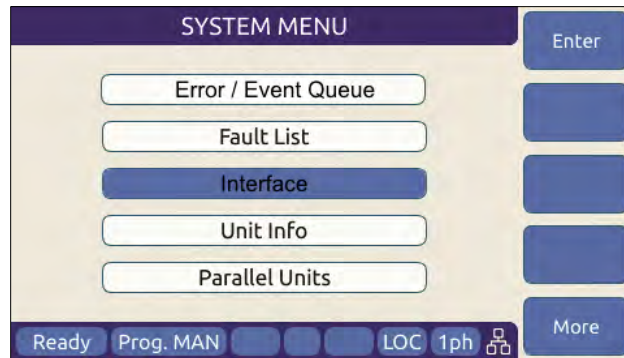

Scroll down to the INTERFACE entry and press Enter to access the available INTERFACE SETUP screen.

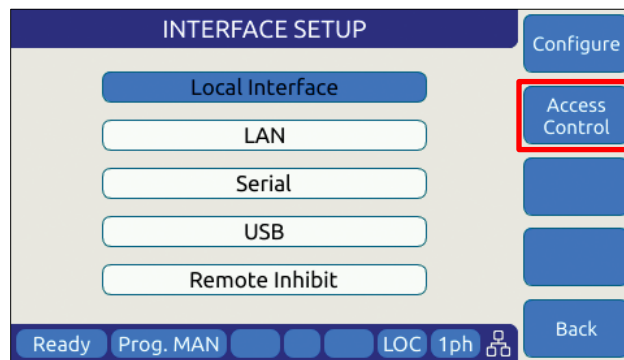

The second soft key is labelled “Access Control” and brings up the access control screen shown below.

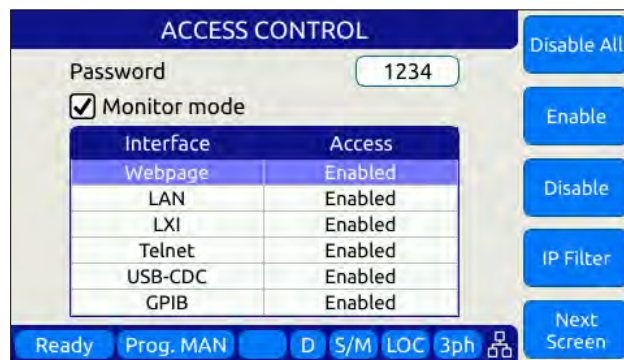

The IP Filter list will provide access to the list of IP addresses that have been granted access by the local operator. This list can be erased if it is necessary to deny future access to the power source.

10.4 Web Browser Interface

The AZX Series® conforms to the LXI (Lan eXtensions for Instrumentation) standard and features a built-in web server with a greatly expanded feature set. This allows communication with the AZX from any web browser as long as the AZX is reachable through the network or internet. The expanded feature set of the web server often eliminates the need to use additional Windows or other platform based software.

10.5 Available Web Interface Menu Tree

The following areas of control, monitoring and configuration of the AZX power source are available through a web browser.

- Home Screen – Required for LXI compliance
- Home Screen SCPI Console Command Line Interface
- SOURCE CONTROL
 - PROGRAM
 - PROTECTIONS
 - TRANSIENTS
 - PROGRAM MEMORY
 - WAVEFORM
 - WAVEFORM EDITOR
 - SCPI SCRIPT
- MEASUREMENTS
 - MONITOR
 - REAL-TIME PLOT
 - V/I PLOT
 - DATALOGGER
 - SCOPE
 - HARMONICS
- CONFIGURATION
 - UNIT SETTINGS
 - USER LIMITS & PRESETS
 - RAMP & SLEW
- SYSTEM
 - ERROR/EVENT QUEUE
 - FAULT LIST
 - INTERFACE SETUP
 - ACCESS CONTROL
 - DIGITAL & ANALOG IOS
 - UNIT INFORMATION
 - PARALLEL UNITS
 - MEMORY MANAGER
 - CALIBRATION
 - REMOTE SUPPORT
 - IMPORT/EXPORT
 - FIRMWARE UPDATE
 - SANITIZE & REBOOT

Following sections provide an overview of each page of the web browser interface.

10.6 Home Screen

The Home screen contains all required information relating to the instrument and its LAN connection as required by the LXI standard. This includes hardware and firmware revision information. The NTP clock **SYNC** button in the Current Time field is yellow if it detects that the date, time or zone is different than the computer, otherwise is in gray. Press the button to sync to the NTP time server.

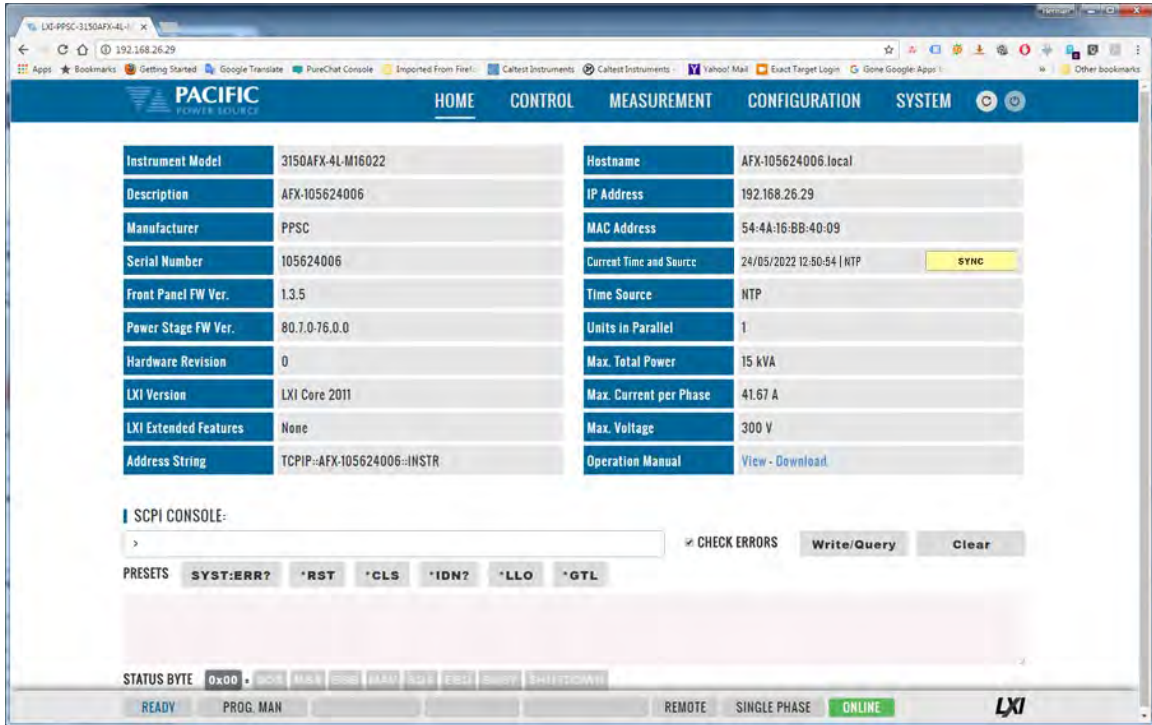

10.6.1 SCPI Console Command Line Interface

Near the bottom of the screen is an interactive command line interface that allows individual SCPI commands to be sent to the instrument. Any query results are shown in the text box below the command line. A drop-down list of all available commands is integrated in the command line and as you type a command, a match will be tracking in the drop down list allowing you to select the complete command without typing it out. See sample below after typing “SY”.



Note: AZX models also support a SCPI Command scripting function. See Section 10.7.9, “SCPI Script” on page 595.

10.6.2 Status Byte Display

At the very bottom of the Home Screen, the status byte register value and decoded fields are displayed for reference. Status byte fields are described in section 8.12.1, “Status Byte Register (STB)” on page 549.

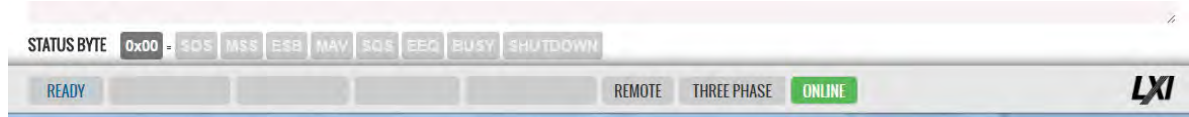

10.6.3 Browser Status Bar

The browser status bar shows configuration information about the instrument. This includes any error or event flags, remote or local status, phase mode selection and on or off line status.



The first field will display **READY** while the power source output is OFF and **ENABLED** when it is ON (enabled).

10.6.4 Operation Manual PDF

The AZX Operation Manual is stored on the AZX’s internal memory and available for download to the user’s PC (“Download”) or for viewing using a suitable browser of PDF viewer (“View”).

PACIFIC POWER SOURCE		HOME CONTROL MEASUREMENT CONFIGURATION SYSTEM	
Instrument Model	3150AFX-4L-M16022	Hostname	AFX-105624006.local
Description	AFX-105624006	IP Address	192.168.26.29
Manufacturer	PPSC	MAC Address	54-4A-16-BB-40-09
Serial Number	105624006	Current Time	30/01/2017 15:16:13
Front Panel FW Ver.	1.3.5	Time Source	NTP
Power Stage FW Ver.	80.7.0-76.0.0	Units in Parallel	1
Hardware Revision	0	Max. Total Power	15 kVA
LXI Version	LXI Core 2011	Max. Current per Phase	41.67 A
LXI Extended Features	None	Max. Voltage	300 V
Address String	TCPIP::AFX-105624006::INSTR	Operation Manual	View - Download

10.7 Source Control Screens

The CONTROL menu provides access to several screens that allow programming of the power source. Control Menu entries are as follows:

- PROGRAM
- PROTECTIONS
- TRANSIENT
- ANALOG PROGRAMMING
- INTERHARMONICS & HARMONICS
- PROGRAM MEMORY
- WAVEFORM
- WAVEFORM EDITOR
- SCPI SCRIPT
- TEST SEQUENCE

Each is described in subsequent sections.

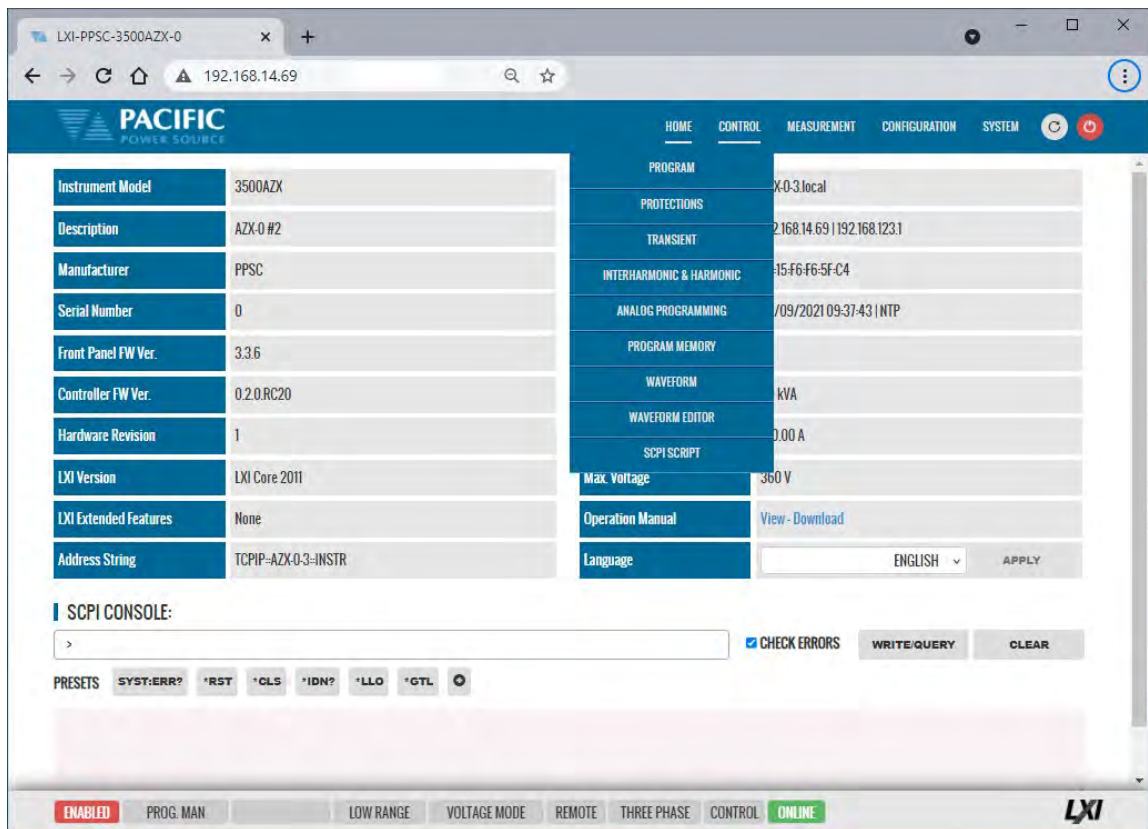

10.7.1 Program

The program control screen allows programming of all output parameters, operating modes etc. It also displays measurement data for all available phases in the lower part of the screen. In three or two phase mode, Line-to-Line voltage measurements are displayed at the bottom of the screen. The Output can be enabled using the “OUTPUT ENABLE” controls in the upper PROGRAM screen. The Output can also be turned **OFF** from any screen using the RED On/Off symbol in the menu bar, which is accessible from all screens. This allows quick opening of the output relay if needed from any screen without have to first select the PROGRAM screen. Note that the output can only be turned **ON** (or OFF) from the PROGRAM screen however.

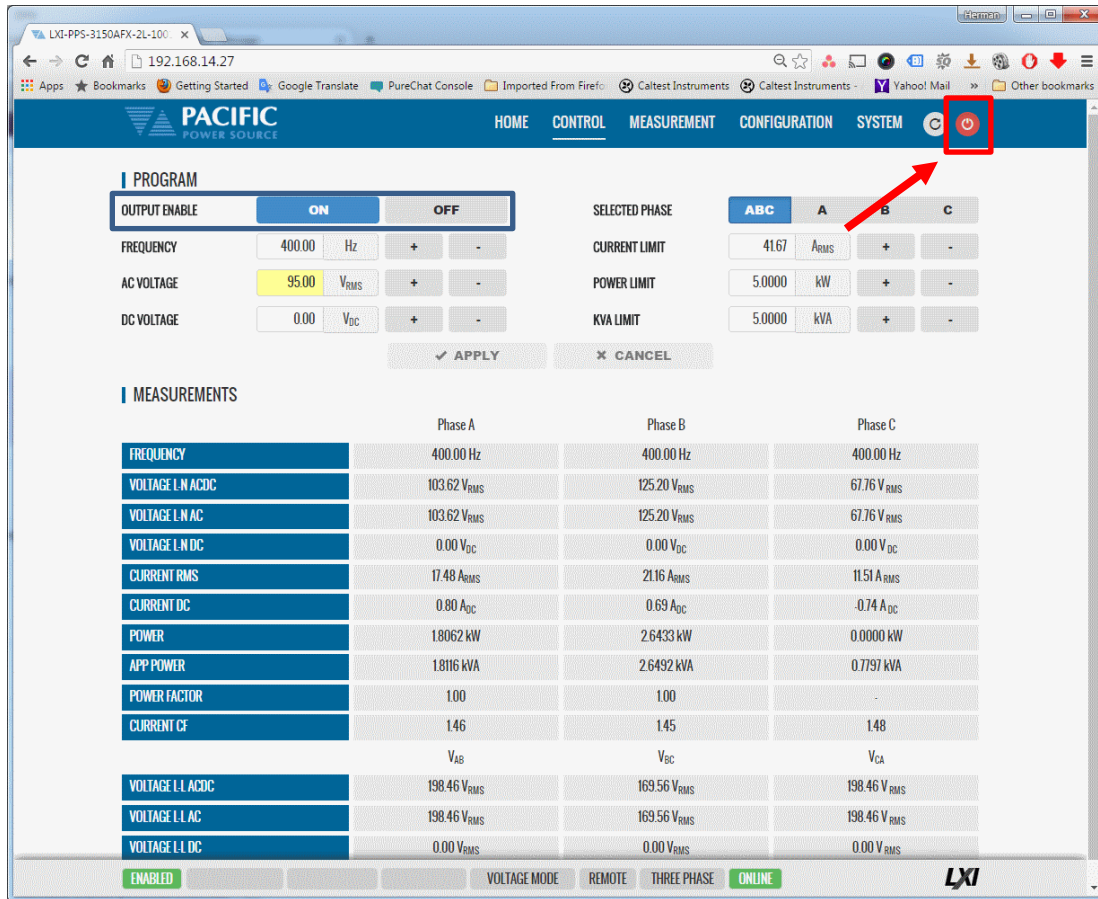

The Program screen displayed is a function of the selected operating mode in the System Configuration screen (See image). Depending on the selected mode, the following Program screens are available:

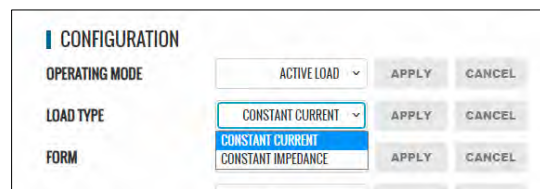

- Voltage Source Programming (see above)
- Current Source Programming
- Load Programming

10.7.1.1 Voltage Source Programming

Allows setting of Frequency, AC voltage, DC voltage, Phase Angles for phase B and C, Current Limit, Power Limit and KVA Limit.



The screenshot shows the 'PROGRAM' section of the Pacific Power Source web interface. The 'OUTPUT ENABLE' is set to 'ON'. The 'SELECTED PHASE' is 'ABC'. The settings are as follows:

Parameter	Value	Unit	Adjustment
FREQUENCY	400.00	Hz	+ / -
AC VOLTAGE	95.00	V _{RMS}	+ / -
DC VOLTAGE	0.00	V _{DC}	+ / -
CURRENT LIMIT	41.67	A _{RMS}	+ / -
POWER LIMIT	5.0000	kW	+ / -
KVA LIMIT	5.0000	kVA	+ / -

Buttons: ✓ APPLY, ✗ CANCEL

10.7.1.2 Current Source Programming

In current source mode, programming output parameters is similar to Voltage mode but the AC and DC Current can be programmed instead of the voltage.

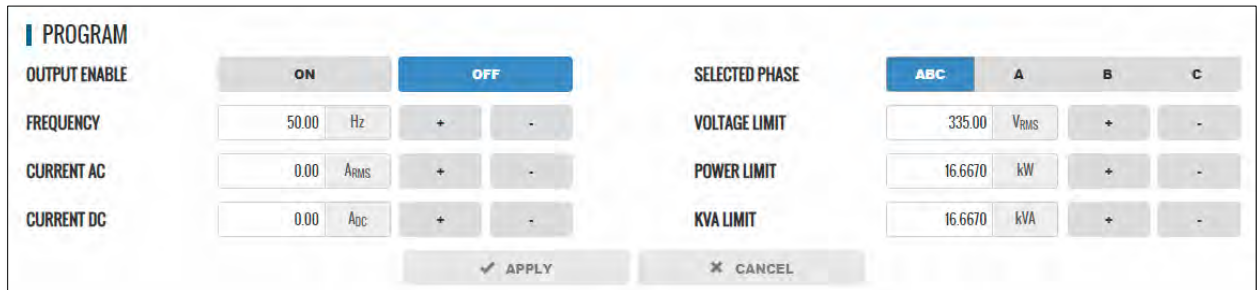

The screenshot shows the 'PROGRAM' section of the Pacific Power Source web interface in current source mode. The 'OUTPUT ENABLE' is set to 'OFF'. The 'SELECTED PHASE' is 'ABC'. The settings are as follows:

Parameter	Value	Unit	Adjustment
FREQUENCY	50.00	Hz	+ / -
CURRENT AC	0.00	A _{RMS}	+ / -
CURRENT DC	0.00	A _{DC}	+ / -
VOLTAGE LIMIT	335.00	V _{RMS}	+ / -
POWER LIMIT	16.6670	kW	+ / -
KVA LIMIT	16.6670	kVA	+ / -

Buttons: ✓ APPLY, ✗ CANCEL

10.7.1.3 Load Programming

Load programming screens depend on the load mode selected.

Constant Current Mode (AC and DC)

In constant current AC mode, the load has to synchronize to the AC voltage present at the load input. To allow the load to sync up as fast as possible, the expected input AC voltage frequency can be set using the “SYNC FREQUENCY” setting. The SYNC status of the AC load is displayed as either **SYNCED** or **UNSYNCED** in the STATUS field at the bottom of the programming section. Sync applies to the AC component and can be turned off as needed.

Other parameters that are programmable are phase shift, RMS and DC Current level as well as POWER, KVA and Peak Voltage protection limits

CONSTANT CURRENT LOAD

<p>OUTPUT ENABLE: ON OFF</p> <p>CURRENT AC: <input type="text" value="0.00"/> A_{RMS} + -</p> <p>CURRENT DC: <input type="text" value="0.00"/> A_{DC} + -</p> <p>PHASE SHIFT: <input type="text" value="0.0"/> ° + -</p> <p>SYNC: ON OFF</p> <p>SYNC FREQUENCY: <input type="text" value="60.00"/> Hz + -</p> <p>STATUS: UNSYNCED</p>	<p>SELECTED PHASE: ABC A B C</p> <p>POWER LIMIT: <input type="text" value="16.667"/> kW + -</p> <p>KVA LIMIT: <input type="text" value="16.667"/> kVA + -</p> <p>OVP: <input type="text" value="350.00"/> V + -</p> <p>RECTIFIER WAVEFORM CF: ⊕ Disabled + -</p>
--	--

Constant Resistance Mode (AC and DC)

In constant resistance AC mode, the load has to synchronize to the AC voltage present at the load input. To allow the load to sync up as fast as possible, the expected input AC voltage frequency can be set using the “SYNC FREQUENCY” setting. The SYNC status of the AC load is displayed as either **SYNCED** or **UNSYNCED** in the STATUS field at the bottom of the programming section. Sync applies to the AC component and can be turned off as needed.

The following controls are available in browser mode:

- AC only shows AC setpoints, and it is more appropriate for AC applications.
- DC only shows DC setpoints, and it is more appropriate for DC applications. It hides frequency, phase and phase shift because for DC only these does not affect the behavior.
- AC & DC is more generic and allows the user to program both independently.
- AC = DC applies the same resistance to both.
- For RMS modes, the default selection is AC=DC
- For Instant modes the default selection is DC

This mode support four **Load Type Settings**:

1. Resistance RMS

Resistance values can be set for AC and DC component individually in AC+DC mode. AC=DC setting applies the same resistance value to both components. In RMS Mode, the load regulates the AC rms and DC rms current using either the standard Sine wave for a user selected waveform including the Rectifier waveform. Thus, the current waveform may be different from the AC input voltage waveform. The Infinite button  -Infinite Ohm may be used to obtain a zero AC or DC current.

CONSTANT RESISTANCE LOAD

OUTPUT ENABLE	<input type="checkbox"/> ON <input checked="" type="checkbox"/> OFF	SELECTED PHASE	<input checked="" type="radio"/> ABC <input type="radio"/> A <input type="radio"/> B <input type="radio"/> C
TYPE	RESISTANCE RMS ▾	CURRENT LIMIT	130.00 A _{rms} <input type="button" value="+"/> <input type="button" value="-"/>
RESISTANCE AC	<input type="button" value="∞"/> 10.00 Ohm <input type="button" value="+"/> <input type="button" value="-"/>	POWER LIMIT	16.667 kW <input type="button" value="+"/> <input type="button" value="-"/>
RESISTANCE DC	<input type="button" value="∞"/> 10.00 Ohm <input type="button" value="+"/> <input type="button" value="-"/>	KVA LIMIT	16.667 kVA <input type="button" value="+"/> <input type="button" value="-"/>
	<input type="radio"/> AC <input type="radio"/> DC <input checked="" type="radio"/> AC & DC <input type="radio"/> AC = DC	DVP	350.00 V <input type="button" value="+"/> <input type="button" value="-"/>
PHASE SHIFT	0.0 ° <input type="button" value="+"/> <input type="button" value="-"/>	PEAK CURRENT LIMIT	360.00 A <input type="button" value="+"/> <input type="button" value="-"/>
SYNC	<input checked="" type="checkbox"/> ON <input type="checkbox"/> OFF	MAX CURRENT SLEW	2000.00 A/ms <input type="button" value="+"/> <input type="button" value="-"/>
SYNC FREQUENCY	60.00 Hz <input type="button" value="+"/> <input type="button" value="-"/>	RECTIFIER WAVEFORM CF	<input checked="" type="radio"/> Disabled <input type="button" value="+"/> <input type="button" value="-"/>
STATUS	UNSYNCED		

2. Conductance RMS

Analog to resistive RMS but the setpoints are in conductance units or siemens. It is useful because a zero setpoint generates 0 whereas a zero setting in CR mode would require an infinite current.

The screenshot shows the 'CONSTANT RESISTANCE LOAD' control panel. The 'OUTPUT ENABLE' is set to 'OFF'. The 'TYPE' is set to 'CONDUCTANCE RMS'. The 'CONDUCTANCE AC' and 'CONDUCTANCE DC' are both set to 0.00 mS. There are '+' and '-' buttons for adjusting these values.

3. Instant Resistance

Instant Resistance mode differs from the Resistance RMS mode in that it uses the instantaneous input voltage instead of the input voltage RMS value to regulate the current. For the AC component, the sine or any arbitrary waveform controls the instantaneous resistance value as a function of time.

The screenshot shows the 'CONSTANT RESISTANCE LOAD' control panel in 'INSTANT RESISTANCE' mode. The 'OUTPUT ENABLE' is 'OFF'. The 'TYPE' is 'INSTANT RESISTANCE'. The 'RESISTANCE AC' and 'RESISTANCE DC' are both set to 10.00 Ohm. The 'PHASE SHIFT' is 0.0°. The 'SYNC' is 'ON' and the 'STATUS' is 'UNSYNCED'. On the right, there is a table for 'SELECTED PHASE' settings:

SELECTED PHASE	ABC	A	B	C
CURRENT LIMIT	130.00	A _{RMS}	+	-
POWER LIMIT	16.667	kW	+	-
KVA LIMIT	16.667	kVA	+	-
OVP	350.00	V	+	-
PEAK CURRENT LIMIT	360.00	A	+	-
MAX CURRENT SLEW	2000.00	A/ms	+	-

4. Instant Conductance

Analog to instant resistance but the setpoints are in conductance units or siemens

The screenshot shows the 'CONSTANT RESISTANCE LOAD' control panel in 'INSTANT CONDUCTANCE' mode. The 'OUTPUT ENABLE' is 'OFF'. The 'TYPE' is 'INSTANT CONDUCTANCE'. The 'CONDUCTANCE AC' and 'CONDUCTANCE DC' are both set to 0.00 mS. There are '+' and '-' buttons for adjusting these values.

Constant Power Mode (AC and DC)

In constant power AC mode, the load has to synchronize to the AC voltage present at the load input. To allow the load to sync up as fast as possible, the expected input AC voltage frequency can be set using the “SYNC FREQUENCY” setting. The SYNC status of the AC load is displayed as either **SYNCED** or **UNSYNCED** in the STATUS field at the bottom of the programming section. Sync applies to the AC component and can be turned off as needed.

This load mode regulates to current as a function of the Input Vac RMS and Vdc level to maintain the set KVA or W set point.

This mode support three **Load Type Settings**:

1. Apparent Power RMS

The DC setpoint produces a DC current that multiplied by the Vrms gives the desired DC KVA.

The AC setpoint produces an AC current (arbitrary or rectifier waveform) that, multiplied by the Vrms, gives the desired AC KVA.

So the difference is whether the load produces an AC and/or DC to obtain the desired KVA.

CONSTANT POWER LOAD

OUTPUT ENABLE	<input type="button" value="ON"/>	<input type="button" value="OFF"/>		SELECTED PHASE	<input type="button" value="ABC"/>	<input type="button" value="A"/>	<input type="button" value="B"/>	<input type="button" value="C"/>
TYPE	<input type="text" value="APPARENT POWER RMS"/> ▾			CURRENT LIMIT	<input type="text" value="130.00"/>	A _{RMS}	<input type="button" value="+"/>	<input type="button" value="-"/>
KVA AC	<input type="text" value="0.00"/>	kVA	<input type="button" value="+"/> <input type="button" value="-"/>	POWER LIMIT	<input type="text" value="16.667"/>	kW	<input type="button" value="+"/> <input type="button" value="-"/>	
KVA DC	<input type="text" value="0.00"/>	kVA	<input type="button" value="+"/> <input type="button" value="-"/>	OVP	<input type="text" value="350.00"/>	V	<input type="button" value="+"/> <input type="button" value="-"/>	
	<input type="radio"/> AC <input type="radio"/> DC <input checked="" type="radio"/> AC & DC			PEAK CURRENT LIMIT	<input type="text" value="360.00"/>	A	<input type="button" value="+"/> <input type="button" value="-"/>	
PHASE SHIFT	<input type="text" value="0.0"/>	°	<input type="button" value="+"/> <input type="button" value="-"/>	MAX CURRENT SLEW	<input type="text" value="2000.00"/>	A/ms	<input type="button" value="+"/> <input type="button" value="-"/>	
SYNC	<input type="button" value="ON"/>			RECTIFIER WAVEFORM CF	<input type="button" value="⊕"/>	Disabled	<input type="button" value="+"/> <input type="button" value="-"/>	
SYNC FREQUENCY	<input type="text" value="60.00"/>	Hz	<input type="button" value="+"/> <input type="button" value="-"/>					
STATUS	<input type="button" value="UNSYNCED"/>							

2. Active Power RMS

The DC setpoint produces a DC current that multiplied by the Vdc gives the desired DC kW active power.

The AC setpoint produces an AC current (arbitrary or rectifier waveform) that multiplied by the Vac*cos(phi) gives the desired AC kW active power.

CONSTANT POWER LOAD		SELECTED PHASE			
OUTPUT ENABLE	<input type="button" value="ON"/> <input checked="" type="button" value="OFF"/>	<input checked="" type="button" value="ABC"/>	<input type="button" value="A"/>	<input type="button" value="B"/>	<input type="button" value="C"/>
TYPE	ACTIVE POWER RMS	CURRENT LIMIT	130.00 A _{RMS}	<input type="button" value="+"/>	<input type="button" value="-"/>
POWER AC	0.00 kW <input type="button" value="+"/> <input type="button" value="-"/>	KVA LIMIT	16.667 kVA	<input type="button" value="+"/>	<input type="button" value="-"/>
POWER DC	0.00 kW <input type="button" value="+"/> <input type="button" value="-"/>	OVP	350.00 V	<input type="button" value="+"/>	<input type="button" value="-"/>
	<input type="radio"/> AC <input type="radio"/> DC <input checked="" type="radio"/> AC & DC	PEAK CURRENT LIMIT	360.00 A	<input type="button" value="+"/>	<input type="button" value="-"/>
PHASE SHIFT	0.0 ° <input type="button" value="+"/> <input type="button" value="-"/>	MAX CURRENT SLEW	2000.00 A/ms	<input type="button" value="+"/>	<input type="button" value="-"/>
SYNC	<input checked="" type="button" value="ON"/>	RECTIFIER WAVEFORM CF	<input checked="" type="button" value="⊕"/> Disabled	<input type="button" value="+"/>	<input type="button" value="-"/>
SYNC FREQUENCY	60.00 Hz <input type="button" value="+"/> <input type="button" value="-"/>				
STATUS	UNSYNCED				

3. Instant Power

The DC setpoint produces an instant current that multiplied by the V(t) gives the desired instantaneous DC power.

The AC setpoint produces an instant current that multiplied by the V(t) gives the desired instantaneous arbitrary waveform of power

CONSTANT POWER LOAD		SELECTED PHASE			
OUTPUT ENABLE	<input type="button" value="ON"/> <input checked="" type="button" value="OFF"/>	<input checked="" type="button" value="ABC"/>	<input type="button" value="A"/>	<input type="button" value="B"/>	<input type="button" value="C"/>
TYPE	INSTANT POWER	CURRENT LIMIT	130.00 A _{RMS}	<input type="button" value="+"/>	<input type="button" value="-"/>
POWER AC	0.00 kW <input type="button" value="+"/> <input type="button" value="-"/>	POWER LIMIT	16.667 kW	<input type="button" value="+"/>	<input type="button" value="-"/>
POWER DC	0.00 kW <input type="button" value="+"/> <input type="button" value="-"/>	KVA LIMIT	16.667 kVA	<input type="button" value="+"/>	<input type="button" value="-"/>
	<input type="radio"/> AC <input type="radio"/> DC <input checked="" type="radio"/> AC & DC	OVP	350.00 V	<input type="button" value="+"/>	<input type="button" value="-"/>
PHASE SHIFT	0.0 ° <input type="button" value="+"/> <input type="button" value="-"/>	PEAK CURRENT LIMIT	360.00 A	<input type="button" value="+"/>	<input type="button" value="-"/>
SYNC	<input checked="" type="button" value="ON"/>	MAX CURRENT SLEW	2000.00 A/ms	<input type="button" value="+"/>	<input type="button" value="-"/>
SYNC FREQUENCY	60.00 Hz <input type="button" value="+"/> <input type="button" value="-"/>				
STATUS	UNSYNCED				

Circuit Emulation Mode (AC and DC)

This mode simulates a wide range of RLC circuit as well as two AC rectifier modes.

Refer to section 3.7.4 on page 35 for mode information on the multitude of load settings that apply in this load mode.

CIRCUIT EMULATION LOAD			
OUTPUT ENABLE	<input type="button" value="ON"/>	<input type="button" value="OFF"/>	
TYPE	R // SERIES RL // SERIES RC ▾		
SYNC	<input checked="" type="checkbox"/>		
SYNC FREQUENCY	60.00 Hz	<input type="button" value="+"/> <input type="button" value="-"/>	
ENABLE	<input checked="" type="checkbox"/>		
RESISTANCE	10.00 Ohm	<input type="button" value="+"/> <input type="button" value="-"/>	
RESISTANCE (RL)	0.001 Ohm	<input type="button" value="+"/> <input type="button" value="-"/>	
INDUCTANCE	1.000 mH	<input type="button" value="+"/> <input type="button" value="-"/>	
RESISTANCE (RC)	0.001 Ohm	<input type="button" value="+"/> <input type="button" value="-"/>	
CAPACITANCE	1000.000 µF	<input type="button" value="+"/> <input type="button" value="-"/>	
INITIAL VOLTAGE	0.00 V	<input type="button" value="+"/> <input type="button" value="-"/>	
STATUS	<input type="button" value="UNSYNCED"/>		
SELECTED PHASE	<input checked="" type="button" value="ABC"/>	<input type="button" value="A"/>	<input type="button" value="B"/>
CURRENT LIMIT	130.00 A _{RMS}	<input type="button" value="+"/> <input type="button" value="-"/>	
POWER LIMIT	16.667 kW	<input type="button" value="+"/> <input type="button" value="-"/>	
KVA LIMIT	16.667 kVA	<input type="button" value="+"/> <input type="button" value="-"/>	
OVP	350.00 V	<input type="button" value="+"/> <input type="button" value="-"/>	
PEAK CURRENT LIMIT	360.00 A	<input type="button" value="+"/> <input type="button" value="-"/>	
MAX CURRENT SLEW	2000.00 A/ms	<input type="button" value="+"/> <input type="button" value="-"/>	

10.7.2 Protections

The Protections screen may be used to change protection modes and threshold values. This includes RMS current, Peak Current, Peak Voltage, Peak Power, True Power, Apparent Power, Over/Under Frequency and Over/Under Voltage protection modes. Modes can be toggled on or off individually.

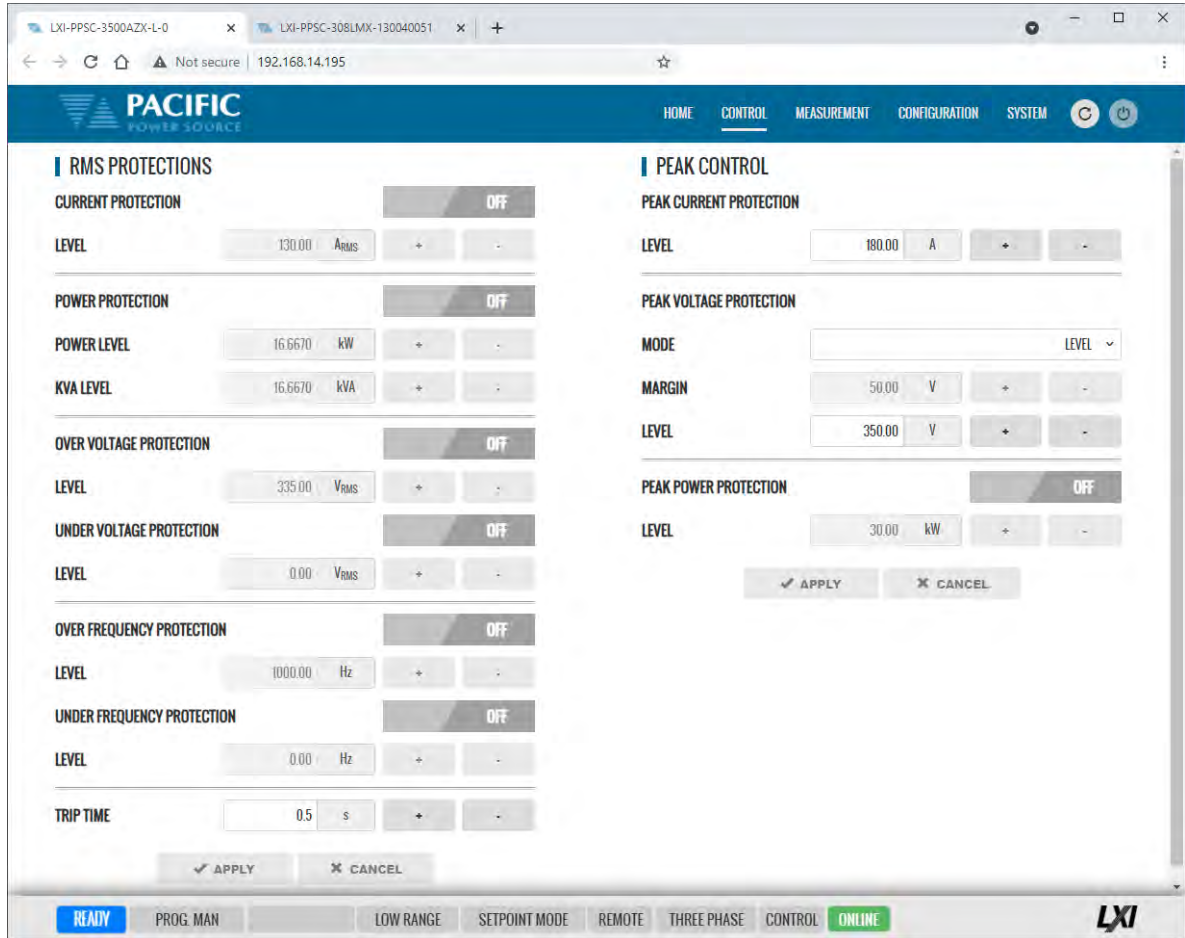

10.7.3 Transients

The transient control screen allows programming of new transients or execution control of new or stored transient programs. The power source supports LIST, STEP and PULSE transient modes.

The screenshot shows the LXI web interface for a Pacific Power Source. The main content area is divided into two columns. The left column contains a list of device information, and the right column contains configuration options. A red box highlights the 'TRANSIENT' and 'PROGRAM' tabs in the configuration area.

Instrument Model	3150AFX-2AG	PROGRAM	AFX:119412650.local
Description	AFX:119412650	PROTECTIONS	
Manufacturer	PPSC	TRANSIENT	PROGRAM 168.123.1
Serial Number	119412650	PROGRAM MEMORY	STEP
Front Panel FW Ver.	2.2.0.rc4	WAVEFORM	PULSE 12.1 NTP
Controller FW Ver.	82.14.78.0.6	WAVEFORM EDITOR	1
Hardware Revision	A	SCPI SCRIPT	15 kVA
LXI Version	LXI Core 2011	Max. Current per Phase	4167 A
LXI Extended Features	None	Max. Voltage	300 V
Address String	TCPIP-AFX:119412650-INSTR	Operation Manual	View - Download
		Language	ENGLISH <input type="button" value="APPLY"/>

SCPI CONSOLE:

testic Bookings MTD CHECK ERRORS

PRESETS

```
>*IDN?
PPSC, 3150AFX-2AG, 119412650, 2.2.0.rc4
```

STATUS BYTE

READY PROG. MAN LOCAL THREE PHASE CONTROL **ONLINE** LXI

10.7.3.1 LIST Transients

For LIST transients, both STEP mode and SEGMENT mode is supported. The bottom part of the screen shows the editable transient table. Execution controls are located in the top part of the screen.

Data entry mode can be selected as either STEP or SEGMENT. Dwell times can be entered using msec (TIME BASED) or cycles (CYCLE BASED). A sample TIME BASED Segment mode list is shown below.

TRANSIENT EXECUTION

STATE:

PROGRESS: 0%

REPEAT TIMES COUNTER: 0

CONFIGURATION:

RUN FROM SEGMENT #: 1

RUN TO SEGMENT #: 4

REPEAT TIMES: Infinite

TRANSIENT TABLE

MODE:

EDIT MODE:

#	TIME [ms]	FREQ [Hz]	V _{AC} [VRMS] A/B/C	V _{DC} [V] A/B/C	Waveform [#] A/B/C	Phase [deg] B/C	
> 1	1000.0	60.00	120.00	0.02	1	120.00/240.00	+ ×
> 2	16.6	60.00	132.00/120.00/120.00	0.01	1	120.00/240.00	+ ×
> 3	5000.0	60.00	120.00	0.00	1	120.00/240.00	+ ×
> 4	100.0	60.00	120.00/132.00/108.00	0.00	1	120.00/240.00	+ ×

Import / Export Function

List Transients can be saved to excel compatible CSV files using the EXPORT button at the bottom of the List transient screen. A sample is shown to the right.

These same files can be Imported later eliminate the need to re-enter the transient list. The IMPORT button opens a file browser so select and load previously save CSV transient files. This function automatically changes between step or segment mode and edit mode according to the CSV file content.

A sample CYCLE BASED Segment mode list is shown below.

```
transient.csv - Notepad
File Edit Format View Help
SEP=,
Mode=Segment
Edit Mode=Time based
Time[ms],Frequency [Hz],AC [RMS],DC,Phase [Deg], Waveform
10.0,60,5/6/7,30/20/10,0/120/240,1/1/1
200.0,65,5/6/7,30/20/10,0/120/240,1/1/1
200.0,75,0/0/0,0/0/0,0/120/240,2/2/2
```

The screenshot displays the Pacific Power Source web interface. The top navigation bar includes HOME, CONTROL, MEASUREMENT, CONFIGURATION, and SYSTEM. The main content area is divided into two sections:

- TRANSIENT EXECUTION:** This section contains controls for running and stopping transients. The state is currently "STOPPED". It includes fields for "RUN FROM SEGMENT #", "RUN TO SEGMENT #", and "REPEAT TIMES" (set to "Infinite"). Buttons for "RUN", "STOP", "STEP", "RESTART", "APPLY", and "CANCEL" are present.
- TRANSIENT TABLE:** This section displays a table of transient configurations. The "SEGMENT" and "CYCLE BASED" buttons in the "EDIT MODE" section are highlighted with red boxes. The table has columns for #, CYCLES, FREQ [Hz], V_{AC} [Vrms] A/B/C, V_{DC} [V] A/B/C, Waveform [#] A/B/C, and Phase [deg] B/C.

#	CYCLES	FREQ [Hz]	V _{AC} [Vrms] A/B/C	V _{DC} [V] A/B/C	Waveform [#] A/B/C	Phase [deg] B/C
> 1	60	60.00	120.00	0.02	1/1/1	120.00/240.00
> 2	1	60.00	132.00/120.00/120.00	0.01	1/1/1	120.00/240.00
> 3	300	60.00	120.00	0.00	1/1/1	120.00/240.00
> 4	6	60.00	120.00/132.00/108.00	0.00	1/1/1	120.00/240.00

At the bottom of the interface, there are status indicators: READY, PROG MAN, REMOTE, THREE PHASE, CONTROL, and ONLINE (highlighted in green). The LXI logo is visible in the bottom right corner.

Continued on next page...

A sample TIME BASED STEP mode list is shown below. (Not to be confused with STEP Transient mode, see next section.)

The screenshot shows the Pacific Power Source web interface. The 'TRANSIENT EXECUTION' section includes controls for running, stopping, and restarting a transient, along with a progress indicator showing 0% completion. The 'TRANSIENT TABLE' section is active, showing a table of transient steps. The 'STEP' and 'TIME BASED' buttons are highlighted with red boxes. The table contains the following data:

#	RAMP [ms]	DWELL [ms]	FREQ [Hz]	V _{AC} [V _{RMS}] A/B/C	V _{DC} [V] A/B/C	Waveform [#] A/B/C	Phase [deg] B/C		
> 1	0.2	1000.0	60.00	120.00	0.02	1	120.00/240.00	+	×
> 2	0.2	16.8	60.00	132.00/120.00/120.00	0.01	1	120.00/240.00	+	×
> 3	100.0	5000.0	60.00	120.00	0.00	1	120.00/240.00	+	×
> 4	100.0	0.0	60.00	120.00/132.00/108.00	0.00	1	120.00/240.00	+	×

During transient execution, a progress indicator is visible showing percent completion.

10.7.3.2 STEP Transients

STEP transients allow a ramp or stairstep output profile to be programmed without creating LIST transients with multiple entries. In STEP transient mode, the user enters initial value, end value, delta step size, step duration, step count and no of repeats.

The STEP EXAMPLE shows the relationship between the various parameters.

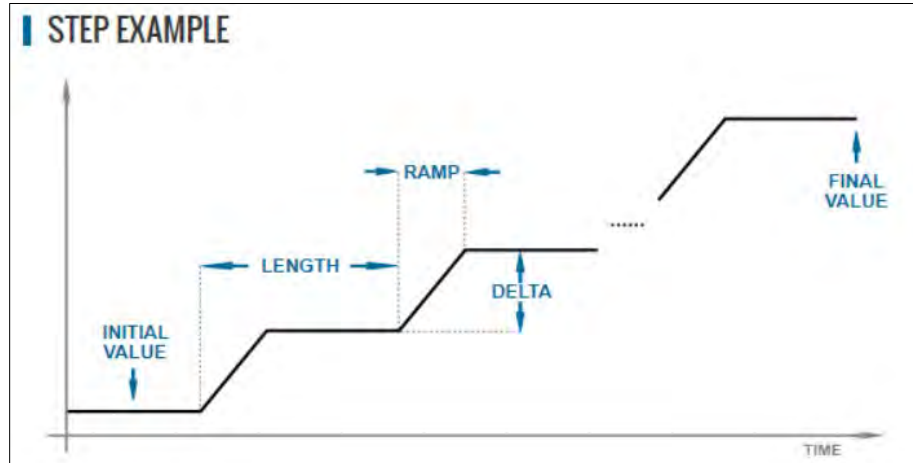

This information is transformed to a standard Segment based transient list by the power source when the LOAD button is pressed.

The screenshot shows the "STEP EXECUTION" control interface. At the top, there are navigation tabs: HOME, CONTROL, MEASUREMENT, CONFIGURATION, and SYSTEM. The "STEP EXECUTION" section includes buttons for RUN, STOP, STEP, and RESTART. The STATE is currently "STOPPED". A progress indicator shows 0%. The REPEAT TIMES COUNTER is 0. A red box highlights the "LOAD" button in the TRANSIENT section. The "STEP SETTINGS" section includes: STEP LENGTH (100.0 ms), STEP RAMP TIME (0.2 ms), STEP COUNT (10), REPEAT TIMES (1), PROGRAM MODE (INITIAL & DELTA VALUES), INITIAL VALUE STEP (ON), and HOLD FINAL VALUES (ON). The "STEP VALUES" section shows a table for parameters across phases A, B, and C.

	SETPOINT	INITIAL	DELTA	FINAL	
FREQUENCY	60.00	60.00	0.00	60.00	Hz
VOLTAGE AC	0.00	0.00	0.00	0.00	V _{rms}
VOLTAGE DC	0.00	0.00	0.00	0.00	V _{dc}

The "STEP WAVEFORM" is set to 1. A "STEP EXAMPLE" graph is also visible in the bottom right, showing the staircase waveform with its parameters.

During transient execution, a progress indicator is visible showing percent completion.

10.7.3.3 PULSE Transients

PULSE transients allow series of pulsed output levels to be programmed without creating LIST transients with repetitive entries. In PULSE transient mode, the user enters Level, duty cycle, ramp time, period initial value and pulse count. This mode is useful for high and low line testing for voltage and frequency operating limits of an EUT.

The PULSE EXAMPLE shows the relationship between the various parameters.

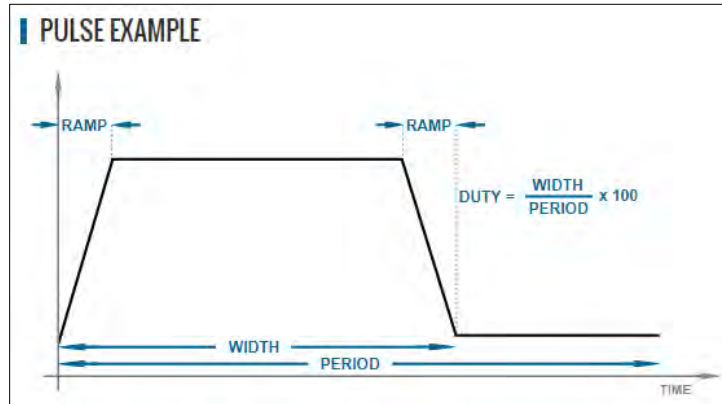

This information is transformed to a standard Segment based transient list by the power source when the LOAD button is pressed.

During transient execution, a progress indicator is visible showing percent completion.

10.7.4 Analog Programming

The Analog Programming browser screen is used to set amplitude and gain for the analog input on the Auxiliary I/O DB25 connector. Available modes are:

OFF	Analog Input disabled
AMP	Amplifier mode. The output of the AC source will be the analog input signal times the AMP GAIN setting. Any offset may be added using the AMP OFFSET field.
AM	Amplifier Modulation mode. The output of the AC source will be modulated by the analog input signal times the AM GAIN setting. Any offset may be added using the AM OFFSET field.
ADD	Summing Mode. The analog input signal will be added (summed) with the output of the AC source.
AMUPC	Same as AM mode but compatible with legacy PPS UPC controller AM mode.

High Power Cutoff Frequency. This field sets the high pass filter (HPF) frequency. With the HPF enabled the DC offset of the analog programming inputs is ignored and the unit will generate AC only. It is useful to remove any DC offset from the input signal.

Moving Average Filter (MAF) This sets the number of input samples to average over. Range is 1 (not filtering) to 4. This function is useful to reduce input noise. When set to a number above 1, the maximum bandwidth is reduced. The analog input sampling frequency is 125kHz except for the fast amplifier mode (requires H option) which is at 500kHz.

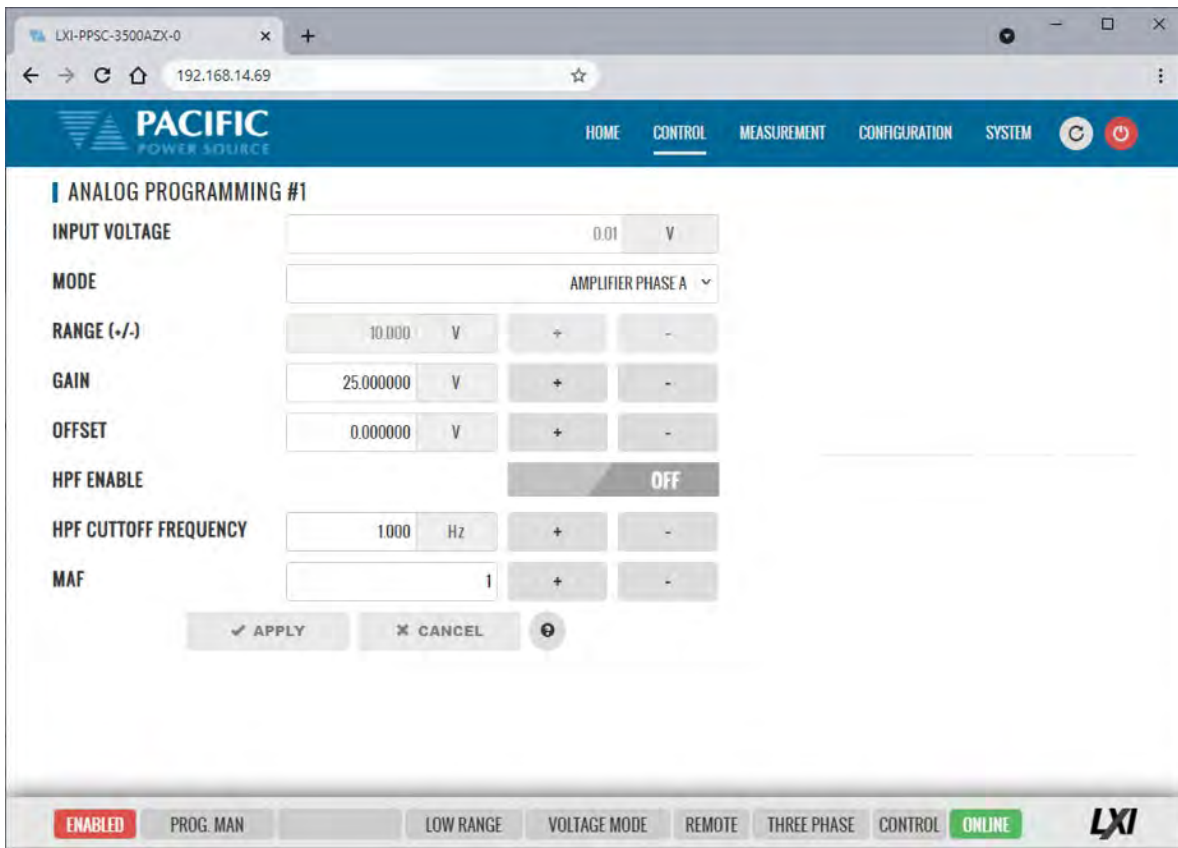

10.7.5 Interharmonic & Harmonic

The Interharmonic & Harmonics screen allows the user to program one interharmonic¹ and up to 5 harmonic frequencies.

The interharmonics frequency and amplitude can be set in the upper part of the screen. The frequency set is independent of the programmed fundamental frequency.

Amplitude can be set in either percent of fundamental or in absolute voltage. Default harmonic numbers are 3, 5, 7, 9, 11 but can be set to any other harmonic order up to 50000th.

The AZX controller uses a precision regulation loop for each of these five harmonics so harmonics amplitude is precisely regulated to compensate for load current and attenuation in the power source amplifiers. This results in a more precise amplitude accuracy for harmonics compared to using an arbitrary waveform.

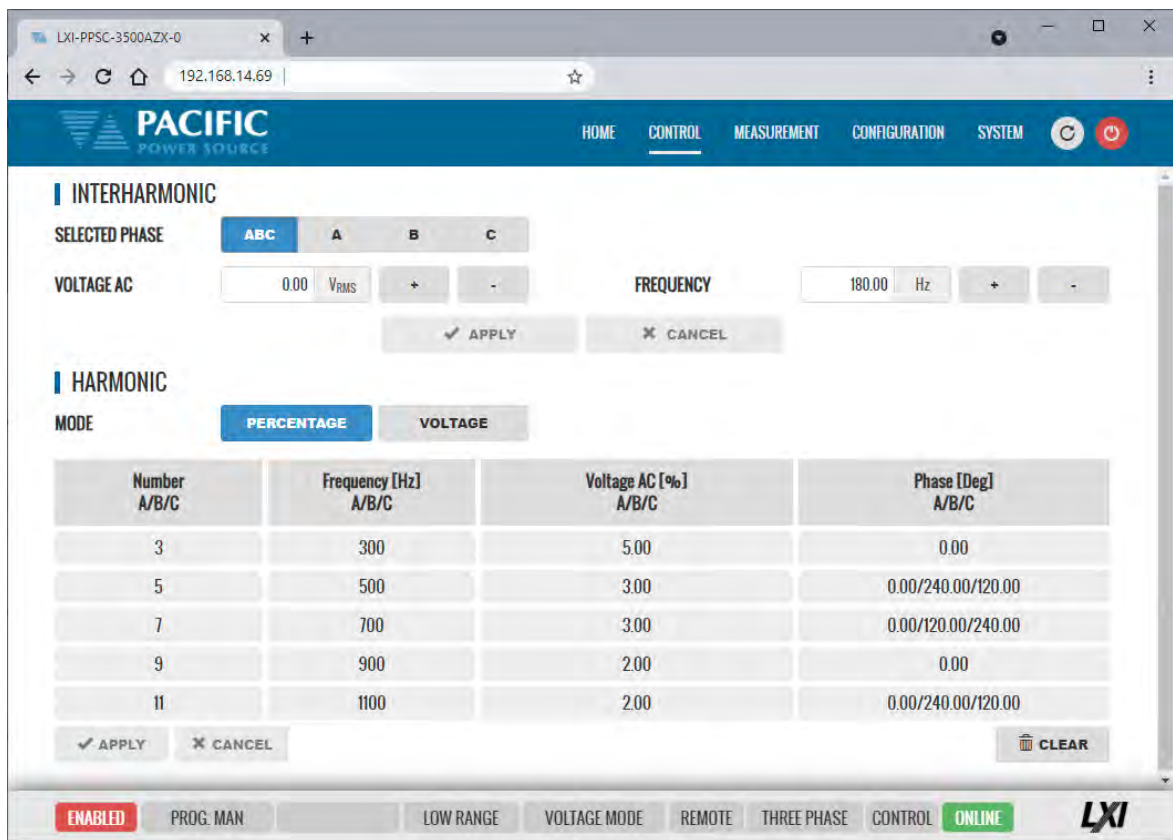

Note 1: Interharmonics are only available and visible if the -413 Interharmonics option is installed. If installed, a “C” will be appended to the AZX model number.

10.7.6 Setpoint Deviation

Deviation settings control how up to three user defined measurement values may be used to adjust either Frequency, Vac or Vdc output (or input in Load mode) settings of the power source/load around a center setting. Changes to these settings will be made at the slew rate set by the user as the selected measurement values change. This information is updated every 100 msec or at a rate of 10Hz. These settings can apply to all phases or individual settings for each phase can be set by the user.

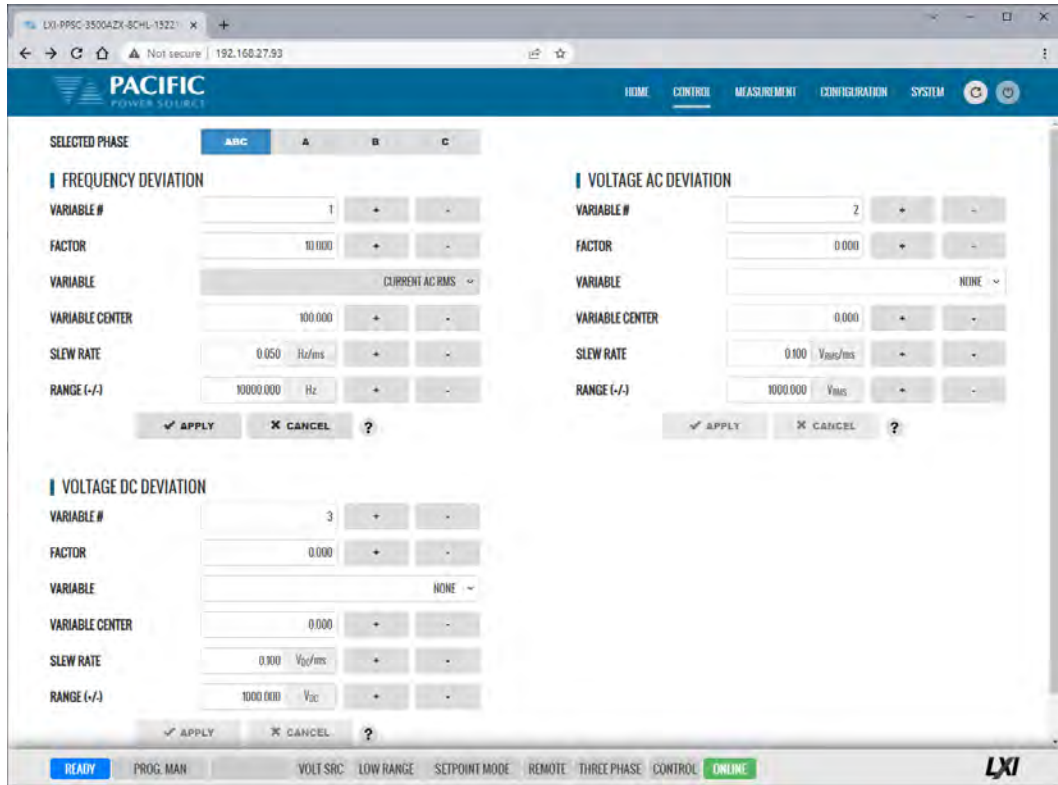

Example

A “weak” power grid can be simulated by adjusting the Frequency setting as a function of the measured phase currents using this feature. For this case “ $F = F_0 - k \cdot I_{rms}$ ” with FACTOR $k = 1$ for 1 Hz change for each Amp of current. Use the RANGE setting to constrain the max. allowed change and the SLEW RATE setting to avoid sudden setting jumps.

The ? button will display the general formula for all three variables:

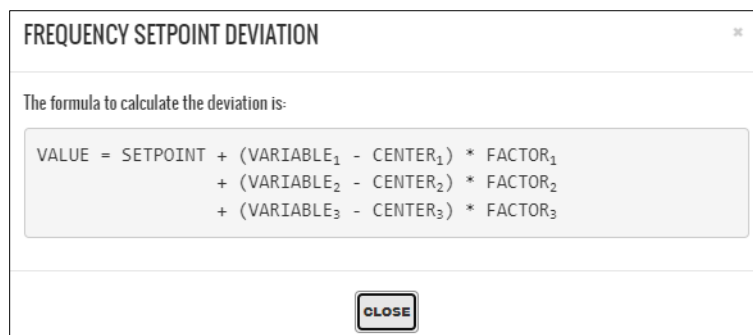

This example shows the variation of the frequency based on the RMS current. Initially the frequency is 50 Hz at 1.0 ARMS. By applying the deviation, the measurement of the frequency is 25 Hz with an RMS current of 80.0 ARMS

FREQUENCY DEVIATION

VARIABLE # + -

FACTOR + -

VARIABLE ▾

VARIABLE CENTER + -

SLEW RATE Hz/ms + -

RANGE (+/-) Hz + -

Parameters

VALUE = 25.0 [Hz]
 SETPOINT = 50.0 [Hz]
 VARIABLE₁ = 80.0 [A_{RMS}]
 CENTER₁ = 1.0
 $50.0 = 25.0 + (80.0 - 1.0) * \text{FACTOR}_1$
 $\text{FACTOR}_1 = \frac{(25.0 - 50.0)}{(80.0 - 1.0)}$
 FACTOR₁ = -0.316

Before:

PROGRAM

OUTPUT ENABLE

FREQUENCY Hz + -

PHASE ° + -

VOLTAGE AC V_{RMS} + -

VOLTAGE DC V_{DC} + -

CURRENT LIMIT A_{RMS} + -

POWER LIMIT kW + -

KVA LIMIT kVA + -

MEASUREMENTS

FREQUENCY	49.98 Hz
VOLTAGE RMS (AC-DC)	115.87 V _{RMS}
VOLTAGE RMS (AC)	115.87 V _{RMS}
VOLTAGE THD	0.05 %
VOLTAGE DC	0.00 V _{DC}
CURRENT RMS (AC-DC)	1.08 A _{RMS}
CURRENT RMS (AC)	1.08 A _{RMS}

Before deviation measurements

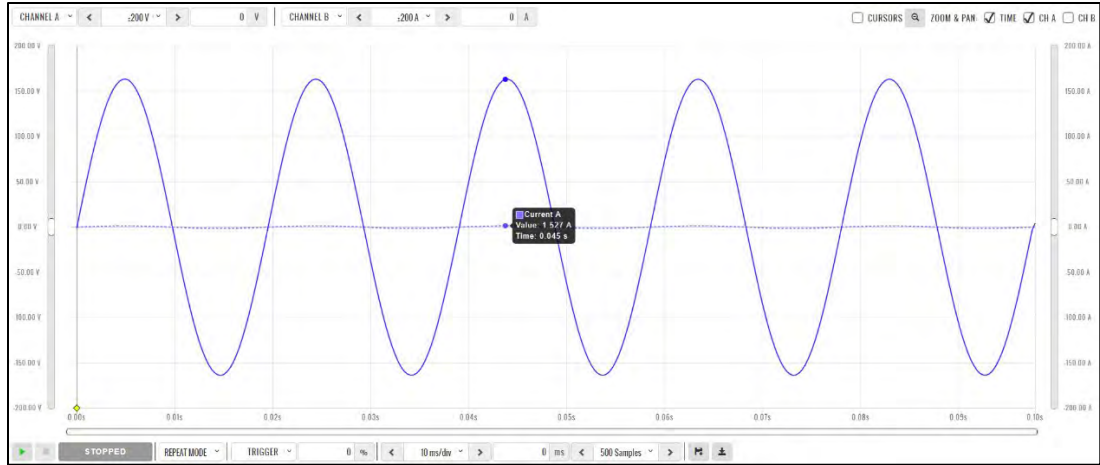

Before deviation capture

After:

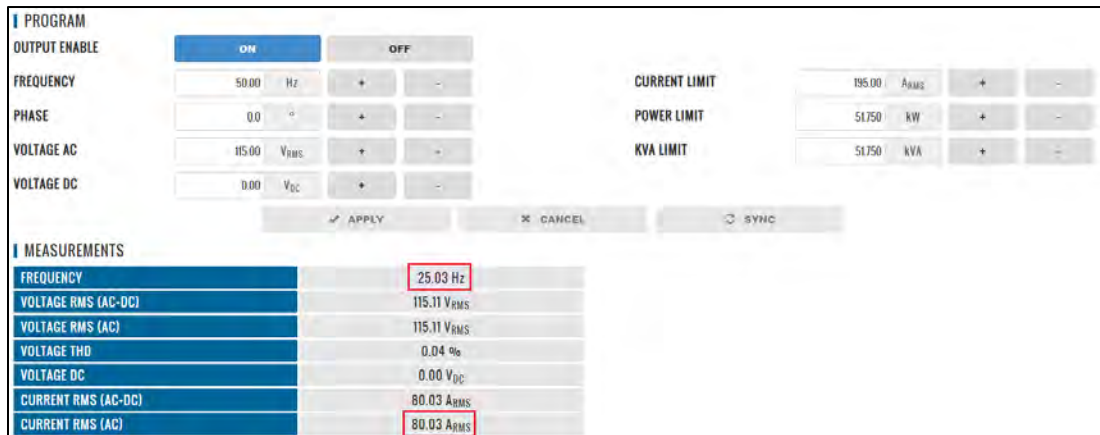

After deviation measurements

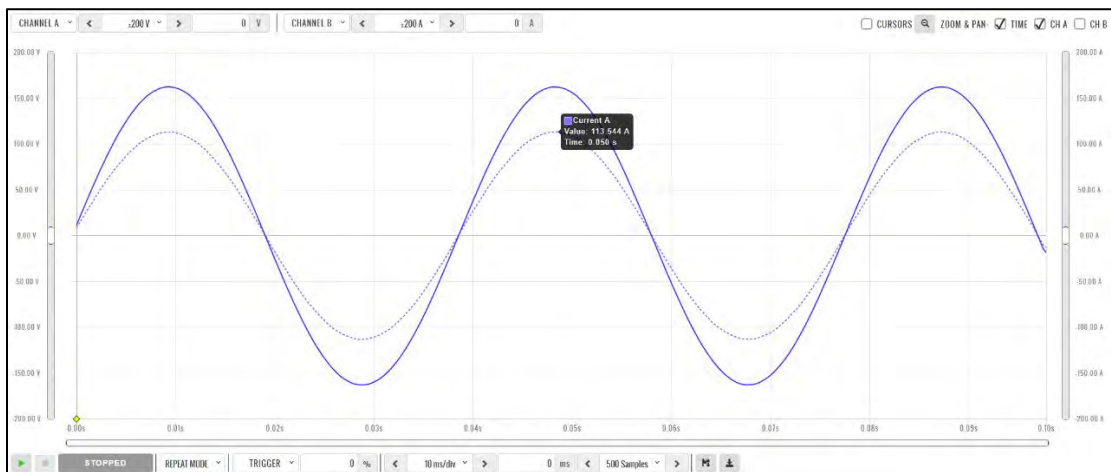

After deviation capture

10.7.7 Program Memory

Program settings and transients can be stored in a number of different memory types. The Program Memory screen allows the user to manage available stored programs. The program to be recalled on power up can be selected at the bottom of this screen in the “POWER ON PROGRAM” area.

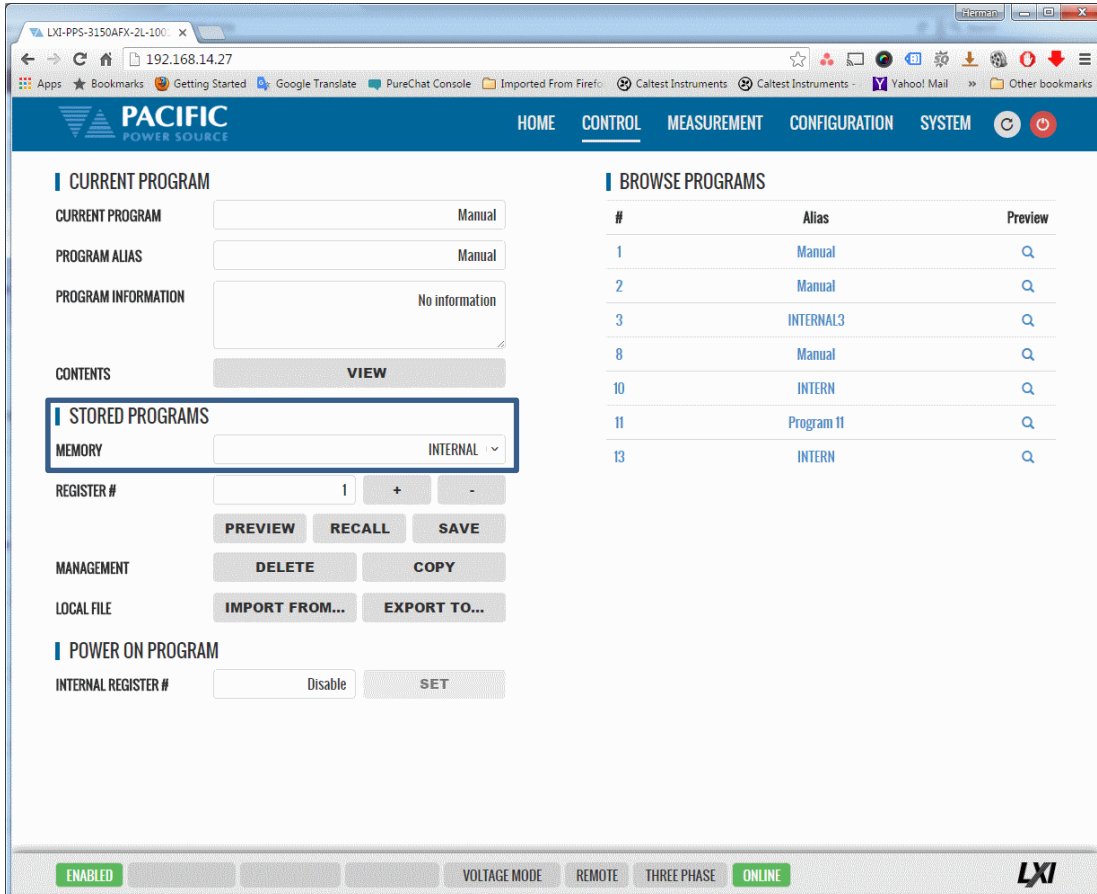

Note that external storage devices may be selected under “**STORED PROGRAMS**” using the MEMORY drop down list control.

10.7.8 Waveform

The power source supports a number of waveforms, most of which are user programmable arbitrary waveforms. The Waveform screen may be used to preview, select and download any of the waveforms stored in internal memory for output on one or more phases. The phase selection “ABC” or separate “A:”, “B” and “C” buttons on the upper right hand side are used to select all or an individual phase. The WAVEFORM drop down list will show all available waveforms.

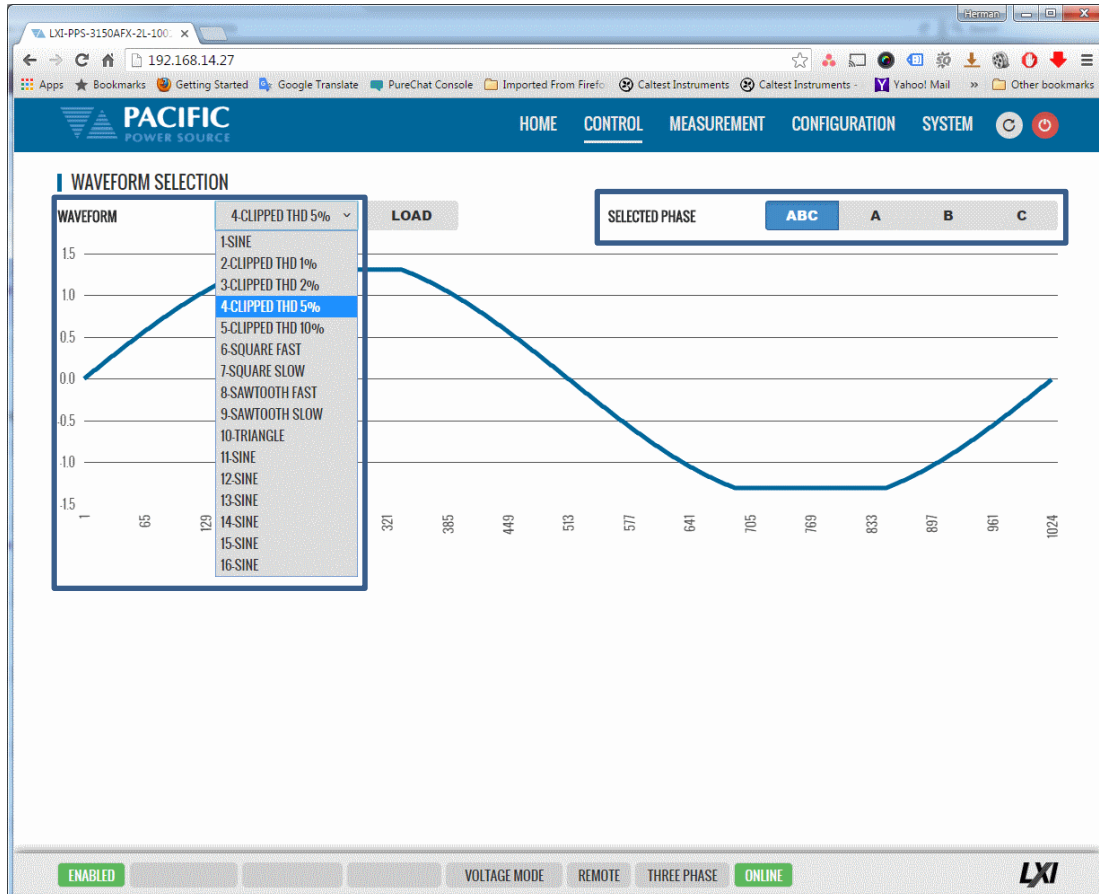

In addition to selecting the active waveform for output, the following controls are available to manage waveforms:



CONTROL	Purpose
IMPORT....	Import csv format waveform data files.
EXPORT...	Export selected waveform to csv format file
EDIT...	Access Waveform Edit screen to edit selected waveform. Also available from the CONTROL pull-down menu.
DELETE	Delete selected waveform. Note: Waveform 1-SINE cannot be deleted.
NEW...	Access the Waveform Edit screen to create a new waveform in the browser.

10.7.9 Waveform Editor

The waveform Editor function allows creation of custom waveforms. Each waveform records consists of 1024 data points (0.35° resolution). Data points can be indexed in Degrees or points. A value can be entered for each data point. There are several tools to generate harmonics, sum to a base sine wave or import a .csv file.

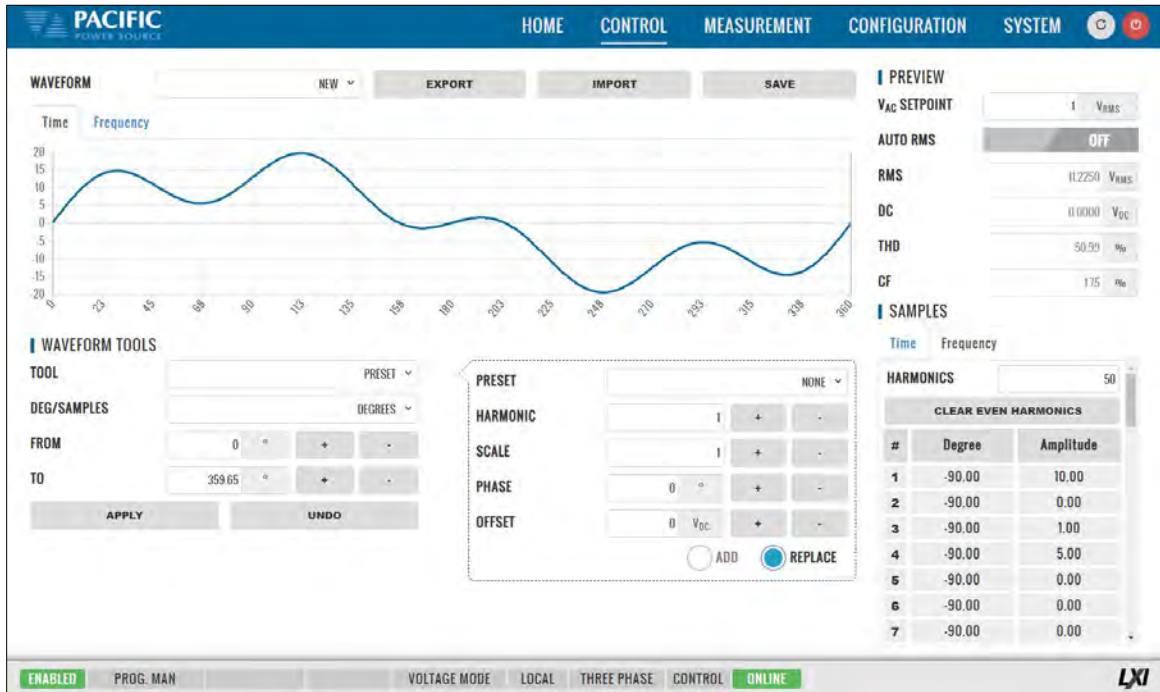

The following tools and controls are available in the Waveform Edit screen:

CONTROL	Purpose
WAVEFORM	Selects any available waveform to edit or select NEW to create a new waveform.
EXPORT	Export selected waveform to csv format file
IMPORT	Import csv format waveform data files.
SAVE	Saves selected waveform to power source memory
SAMPLES	Select no of data points used to defined wave shape. Available settings are 1024 through 2. For best definition, use 1024 data points. Lower point selections will result in interpolation of points in between. All waveforms are stored at 1024-point resolution. See examples on next page.
PREVIEW	
	Vac SETPOINT: Scales vertical axis to show voltage levels.
	AUTO RMS: Scales waveform levels to maintain Vac RMS value specified.
	RMS: Targeted Vac RMS level.
	THD: Shows total harmonic distortion in % of fundamental H1 for voltage waveform.
	DC: Targeted DC offset
	CF: Shows Crest Factor of voltage waveform.

10.7.9.1 Data Points

Waveform creation using direct data entry for each data point is faster when using fewer data points. Examples below show sine wave creation using either 16 or 4 data points. However, data is interpolated linearly for points not displayed in the table on the right hand side.

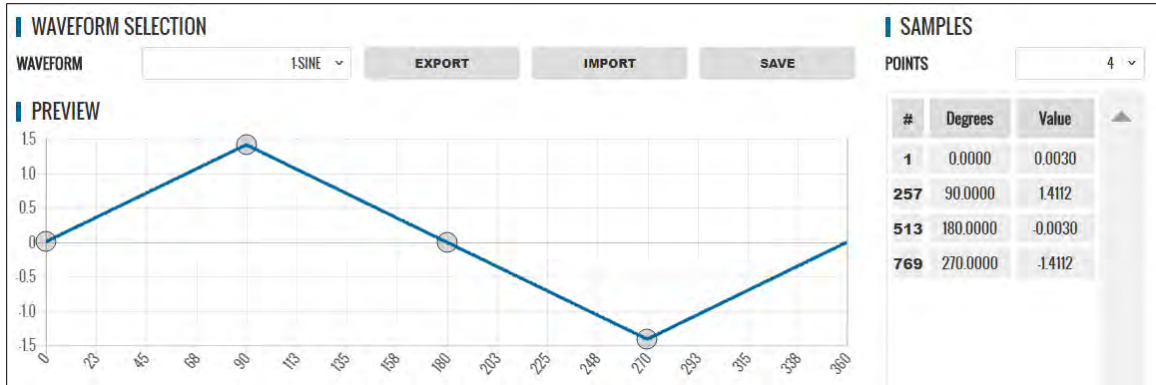

Figure 10-5: Waveform Edit defined using 4 data points

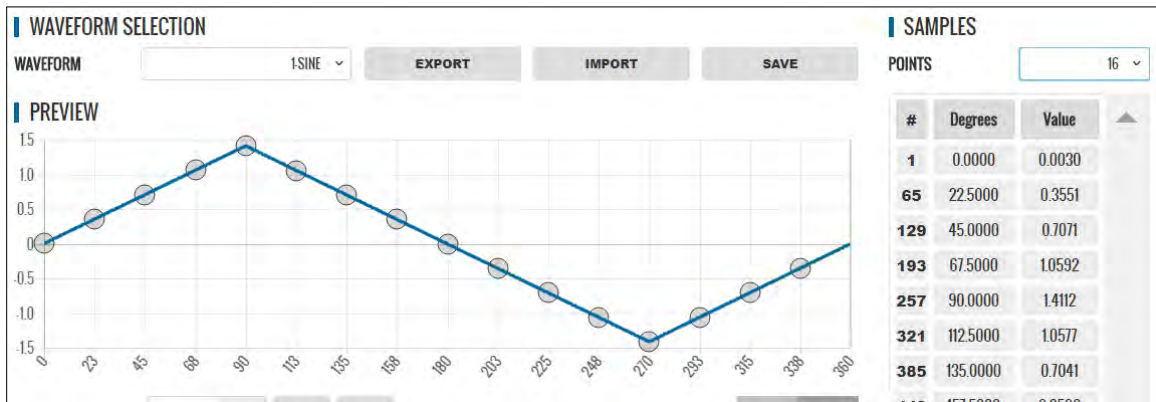

Figure 10-6: Waveform Edit defined using 16 data points

10.7.9.2 Waveform Tools

The following Waveform Tools are available:

CONTROL	Purpose
TOOLS	<p>These selections created specific waveform types without having to define data values manually. Following functions are available from this drop-down:</p> <p>NORMALIZE Normalizes waveform for zero DC offset.</p> <p>RECTIFY Rectifies the waveform. Only positive data points remain. This implies a DC offset which is shown in the DC display field below the graph.</p> <p>FREQ MULTIPLY Creates specified number of periods to multiply fundamental frequency. Use caution with resulting higher frequency waveforms as power source has a finite bandwidth and output may fault if too much high frequency content is present.</p> <p>OFFSET Applies specified DC offset.</p> <p>SCALE Multiplies all data points by scale factor value.</p> <p>VERTICAL FLIP Flips waveform vertically.</p> <p>HORIZONTAL FLIP Flips waveform horizontally.</p> <p>SMOOTHING FILTER Smooths sharp edges to reduce bandwidth requirements.</p> <p>PRESET Selects built-in waveform types based on user parameters.</p>
PRESETS	<p>The following PRESET waveforms are available:</p> <p>NONE Default or no selection made.</p> <p>SINE, TRIANGLE, SQUARE, 6 STEPS, 12 STEPS, SINE POWER, CLIPPED SINE, SAWTOOTH, PULSE, IMPORTED WAVEFORM</p>
PARAMETERS	<p>The following parameters are settable for each PRESET selection:</p> <p>HARMONIC H1 through H32</p> <p>SCALE Vertical Scale Multiplier</p> <p>PHASE Start phase angle</p> <p>OFFSET DC Offset</p> <p>EXPONENT 1 through 51. Applies to SINE POWER present only.</p> <p>THD 0% through 100%. Applies to CLIPPED SINE only.</p> <p>RISE TIME 0° through 360°. Applies to PULSE preset only.</p> <p>PULSE WIDTH 0° through 360°. Applies to PULSE preset only.</p> <p>FALL TIME 0° through 360°. Applies to PULSE preset only.</p> <p>LOAD FROM FILE Available for IMPORTED WAVEFORM preset only.</p> <p>ADD to existing waveform (summation)</p> <p>REPLACE Replace existing waveform with selected PRESET</p>

Example for UL 2231-2 Ringwave Test Waveform Creation.

This immunity test superimposes a decaying sine amplitude on an AC 50Hz or 60Hz line voltage at frequencies of 1kHz, 2kHz, 3kHz, 4kHz and 5kHz. This example shows how to add the 5kHz ring wave to a standard sinewave voltage using the Waveform Editor in the web browser interface.

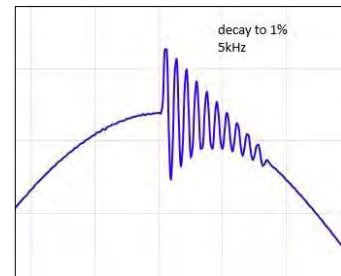
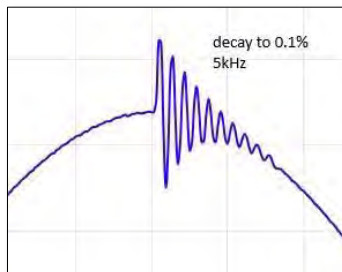
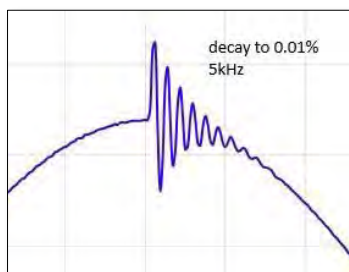

From the Tools menu on the left, select the **RING WAVEFORM** type. The following parameters can be set to create the desired ring wave voltage waveform:

- DECAY:** Represents the decay constant based on the final amplitude value of the ringing signal (1%, 0.1% or 0.01%) of the initial amplitude.
- RING FRQUENCY** This is the frequency multiplier of the base frequency.
- RING AMPLITUDE** This is the (Ringing initial amplitude/Base signal amplitude) ratio.
- DEG (FROM / TO)** Determines the phase angle for the start and end of the ringing signal, as shown in this example, 126-90=36 which is 10% Of the 360° period.



The waveform creating using the editor can be downloaded to the power source using the **SAVE** button. Once loaded, the internal advanced scope function in the web browser interface can be used to capture the actual output waveform as shown below.



10.7.10 Test Sequence

The test sequence feature can be found on the webpage CONTROL menu under “TEST SEQUENCE”. **Note** that this function requires firmware revision 3.7.x or higher.

CONTROL -> TEST SEQUENCE.

It is off by default to save unit memory and takes a few seconds to start once the Test Sequence screen is open the first time after power on.

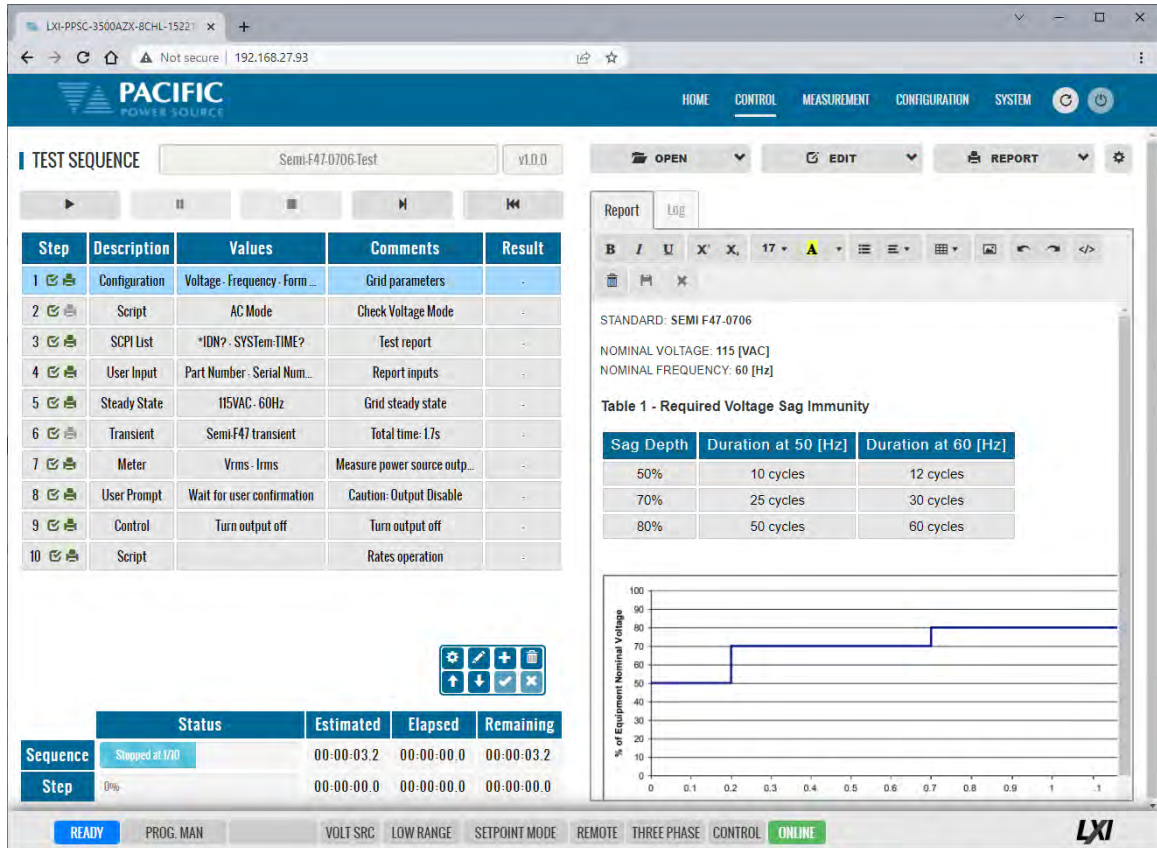

The screenshot shows the 'TEST SEQUENCE' interface for a 'Semi-F47.0706-Test' (v1.0.0). The main table lists 10 steps:

Step	Description	Values	Comments	Result
1	Configuration	Voltage - Frequency - Form ...	Grid parameters	-
2	Script	AC Mode	Check Voltage Mode	-
3	SCPI List	*IDN?; SYSem-TIME?	Test report	-
4	User Input	Part Number - Serial Num...	Report inputs	-
5	Steady State	115VAC - 60Hz	Grid steady state	-
6	Transient	Semi-F47 transient	Total time: 17s	-
7	Meter	Vrms - Irms	Measure power source outp...	-
8	User Prompt	Wait for user confirmation	Caution: Output Disable	-
9	Control	Turn output off	Turn output off	-
10	Script		Rates operation	-

Below the table is a summary table:

Sequence	Status	Estimated	Elapsed	Remaining
Step	0%	00:00:00.0	00:00:00.0	00:00:00.0

The right side of the interface shows a 'Report' section with a table titled 'Table 1 - Required Voltage Sag Immunity':

Sag Depth	Duration at 50 [Hz]	Duration at 60 [Hz]
50%	10 cycles	12 cycles
70%	25 cycles	30 cycles
80%	50 cycles	60 cycles

Below the table is a graph showing '% of Equipment Nominal Voltage' vs. time, with a step function increasing from 50% to 70% at 0.2s and to 80% at 0.7s.

A Test Sequence consists of a group of steps that are executed sequentially. Each step logs the details of said step to a test report. After test execution, this test report can be downloaded or printed using the browser interface.

A Test Sequence step can be any of the following types:

- Configuration
- Steady state
- Transient
- Timer (To perform a delay)
- User prompt (Show information)
- Meter (Performs different measurements)
- Control (Power source control shortcut)
- User input
- Script (For custom procedures, the coding language is Javascript)
- SCPI list (Executes a list of SCPI commands)
- SCPI (Executes a SCPI command)

Note that the sequence engine runs on the power source controller. The browser based webpage only acts as the graphical user interface for test sequence development, execution and reporting. As such, the browser can be closed and reopened without losing any of the test sequence information.

The test sequence functions can also be fully controlled remotely using SCPI commands and the sequences can be stored in the power sources' nonvolatile flash memory. The file format is the industry standard 7z extension compressed file format.

To familiarize yourself with test sequence use and operation, it is recommended to study the four example files provided:

- Sample-test-1.7z
- Sample-test-2.7z
- Sample-test-3.7z
- Sample-test-4.7z

For example, sample-test number 4 performs an IEC 61000-4-11 short voltage interrupt test on any number of user selectable phases. It's content is shown in the browser screen below.

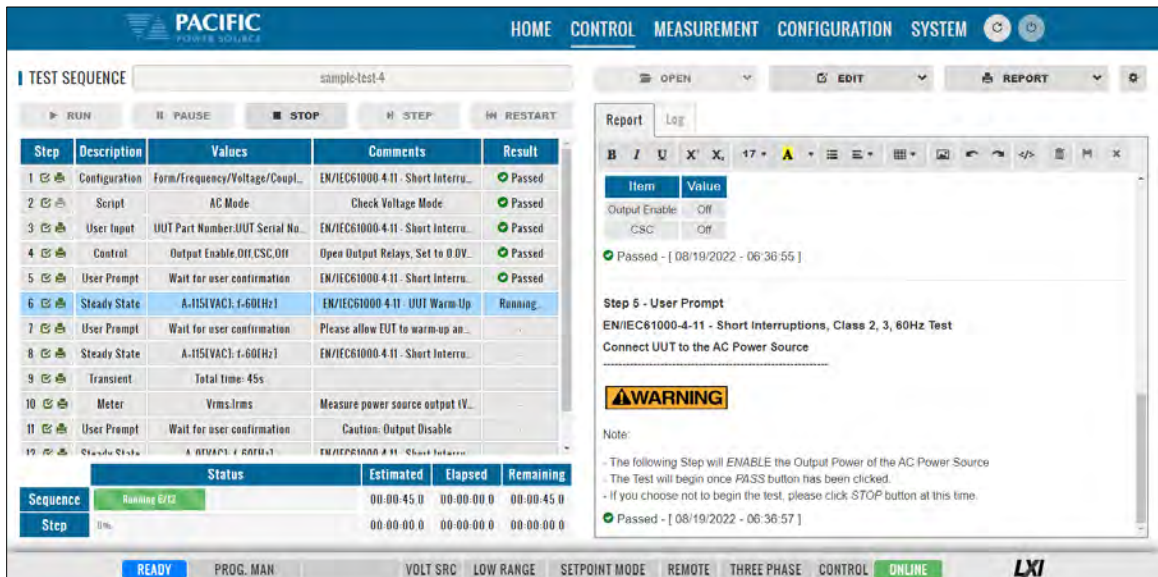

The screenshot displays the Pacific Power Source web interface. At the top, there is a navigation bar with 'HOME', 'CONTROL', 'MEASUREMENT', 'CONFIGURATION', and 'SYSTEM' tabs. Below this, the 'TEST SEQUENCE' section is active, showing a sequence named 'sample-test-4'. The sequence is controlled via buttons for RUN, PAUSE, STOP, STEP, and RESTART. A table lists the steps of the test sequence:

Step	Description	Values	Comments	Result
1	Configuration	Form/Frequency/Voltage/Coupl...	EN/IEC61000-4-11 - Short Interru...	Passed
2	Script	AC Mode	Check Voltage Mode	Passed
3	User Input	UUT Part Number,UUT Serial No...	EN/IEC61000-4-11 - Short Interru...	Passed
4	Control	Output Enable,Off,CSC,Off	Open Output Relays, Set to 0.0V...	Passed
5	User Prompt	Wait for user confirmation	EN/IEC61000-4-11 - Short Interru...	Passed
6	Steady State	A-115(VAC), f-60(Hz)	EN/IEC61000-4-11 - UUT Warm Up	Running
7	User Prompt	Wait for user confirmation	Please allow UUT to warm-up an...	
8	Steady State	A-115(VAC), f-60(Hz)	EN/IEC61000-4-11 - Short Interru...	
9	Transient	Total time: 45s		
10	Meter	Vrms,Irms	Measure power source output IV...	
11	User Prompt	Wait for user confirmation	Caution: Output Disable	
12	Control	A-115(VAC), f-60(Hz)	EN/IEC61000-4-11 - Short Interru...	

Below the table is a summary table with columns for Status, Estimated, Elapsed, and Remaining time. The 'Sequence' status is 'Running 67.0%', with 00:00:45.0 estimated, 00:00:00.0 elapsed, and 00:00:45.0 remaining. The 'Step' status is '11%', with 00:00:00.0 estimated, 00:00:00.0 elapsed, and 00:00:00.0 remaining.

On the right side, a 'Report' window is open, showing a log of events. It includes a 'WARNING' section with the following text:

WARNING

Note:

- The following Step will ENABLE the Output Power of the AC Power Source
- The Test will begin once PASS button has been clicked.
- If you choose not to begin the test, please click STOP button at this time.

The interface also shows various control buttons at the bottom, including 'READY', 'PROG. MAN', 'VOLT SRC', 'LOW RANGE', 'SETPOINT MODE', 'REMOTE', 'THREE PHASE', 'CONTROL', and 'ONLINE'. The 'LXI' logo is visible in the bottom right corner.

For an overview of the available Test Sequence SCPI control command syntax, refer to the Remote Control Programming Section of this manual. (Section 8.13).

10.7.11 SCPI Script

The SCPI Script menu entry displays the command scripting screen. These user generated scripts can contain any sequence of SCPI commands, comments and output statements to automate simple repetitive tasks. Scripts may be used to automate repetitive tasks more quickly and are simpler to write than an actual application program.

A script can be saved to the PC or tablet on which the browser runs.

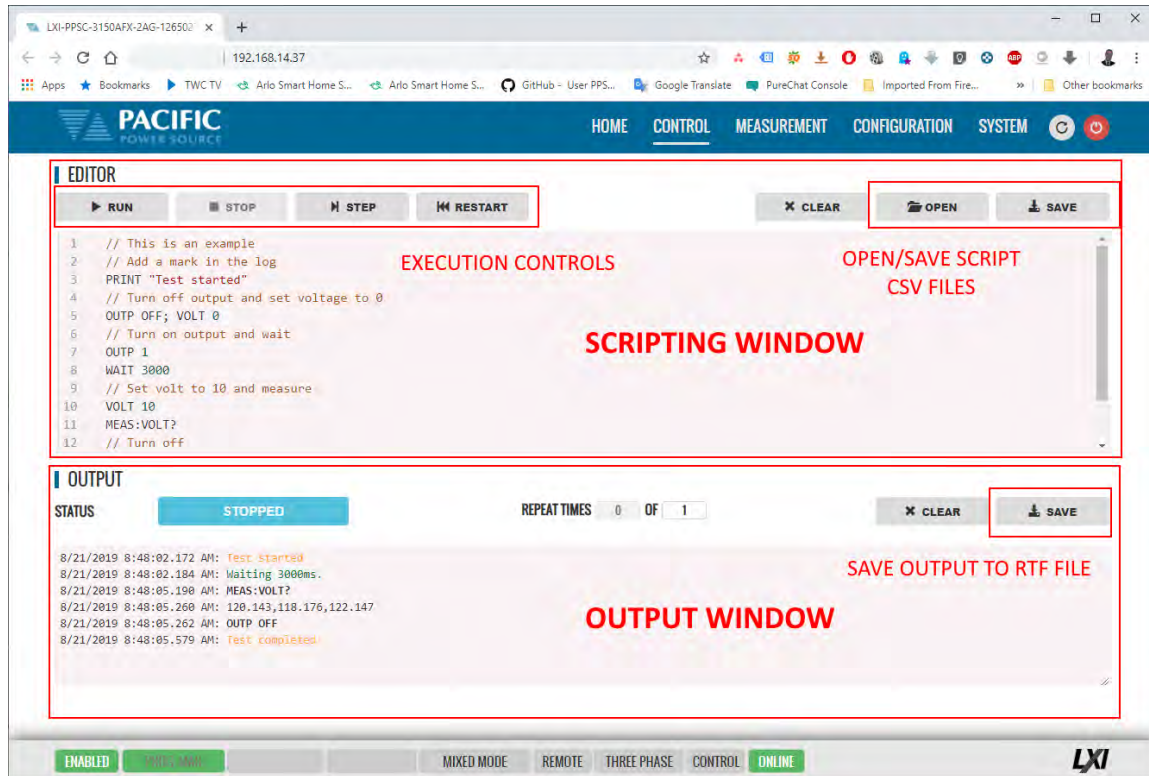

10.7.11.1 Supported Keywords and Commands

The following script entries are supported:

Entry Type	Description
USER COMMENT	// Any test preceded by a two forward slash characters
PRINT	Sends text strings after PRINT key word to the OUTPUT window located at the bottom half of the browser window.
WAIT	Pauses script execution by no of msec specified.
SCPI COMMAND	Any support SCPI command. Data returned by a query command (?) will be printed in the output window.

Table 10-1: Supported Script Entries

10.7.11.2 Script Execution Control

To run a script, click the **RUN** button in the upper left corner of the Editor window. You can also single step through a script during development using the **STEP** button. The **STOP** button will abort execution of a running script. To run a script multiple times, set the **REPEAT TIMES** value to a value higher than the default 1 (one). Max. repeat count is 1+54.

10.7.11.3 Managing multiple script files.

Script files can be saved to the PC or device on which the browser runs, i.e. Windows PC, Tablet, or Smartphone. Use the **OPEN** and **SAVE** buttons in the upper right corner of the Editor window to save and retrieve scripts. Scripts are saved in Comma Separated File format, which can be edited in Excel or any text editor like Notepad. The sample script csv file content (*scpi_script.csv*) is shown below. When saving a new script, replace the default scpi_script file name with a more descriptive file name.

```
// Available commands are:  
// - WAIT MILISECONDS, example -> WAIT 2000  
// - PRINT "TEXT", example -> PRINT "Test started"  
// - SCPI COMMAND/s, example -> OUTP OFF; VOLT 0  
// Comments starts with // as this line  
// The following is an example  
// Add a mark in the log  
PRINT "Test started"  
// Turn off output and set voltage to 0  
OUTP OFF; VOLT 0  
// Turn on output  
OUTP 1  
// Wait three seconds  
WAIT 3000  
// Set output voltage to 10 volts  
VOLT 10  
// Get output voltage measurement  
MEAS:VOLT?  
// Turn off  
OUTP OFF  
PRINT "Test completed"
```

10.7.11.4 Script Execution Output

The OUTPUT window located in the bottom half of the browser window shows all script output, including any user comments, events like script start and stop as well as any PRINT commands. Each output entry is date and time stamped.

The content of the **OUTPUT** window can be saved to a Rich Text File using the **SAVE** button in the upper right corner of the OUTPUT window. (Do not confuse with the SAVE button in the script EDITOR window.) The default output file name is "*scpi_script_output.rtf*". A sequence number (1), (2) etc. will be appended each time the output window content is saved.

A sample RFT file is shown below.

```
8/21/2019 8:48:02.172 AM: Test started  
8/21/2019 8:48:02.184 AM: Waiting 3000ms.  
8/21/2019 8:48:05.190 AM: MEAS:VOLT?  
8/21/2019 8:48:05.260 AM: 120.143,118.176,122.147  
8/21/2019 8:48:05.262 AM: OUTP OFF  
8/21/2019 8:48:05.579 AM: Test completed
```

Note: All output files are saved to the default Download directory determined by the Browser setting.

10.8 Measurement Screens

The MEASUREMENT menu provides access to several measurement screens. Measurement screens available are:

- MONITOR
- REAL TIME PLOT
- WAVEFORMS
- V/I PLOT
- HARMONICS
- DATALOGGER
- SCOPE
- HARMONICS

Each is described in subsequent sections.

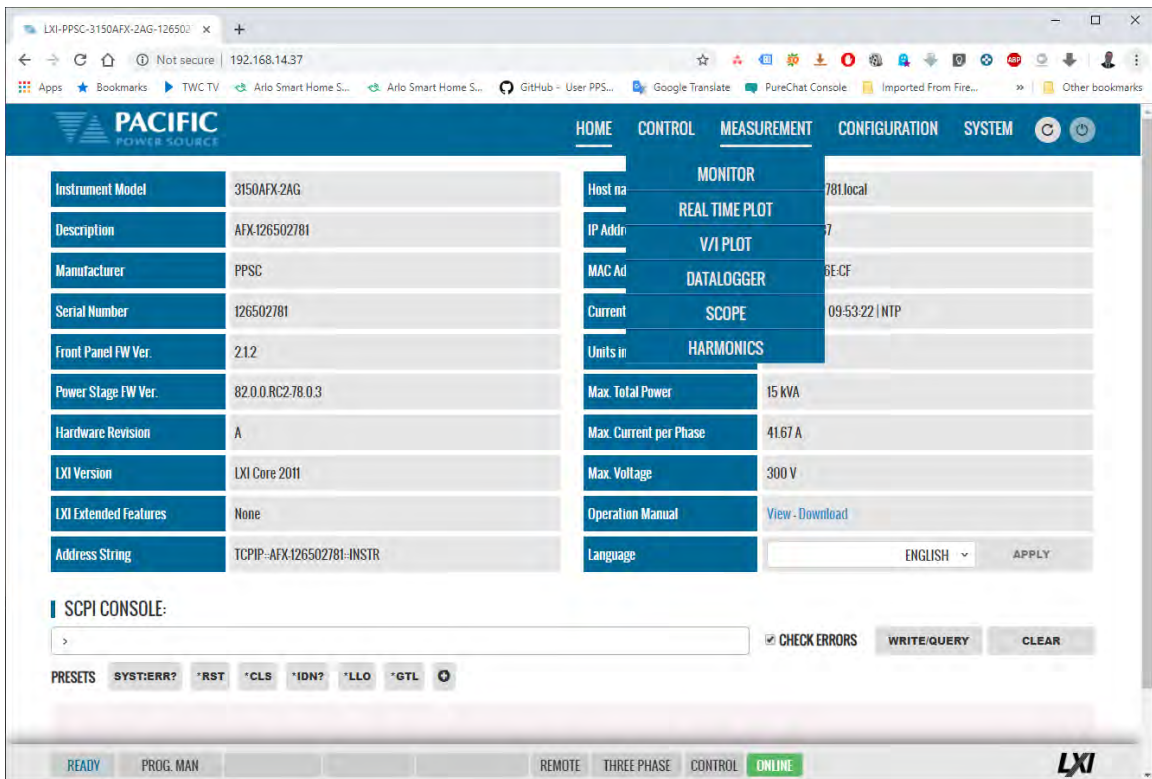

10.8.1 Monitor

The measurement monitor screen replicates part of the CONTROL->PROGRAM screen and displays all measurement data for all available output phases. Measurements include both AC and DC components depending on selected operating mode. As of this revision, there are 26 measurement parameters for each phase for a total of 78. For some measurements like Power Factor and Current CF, the derivate measurements can be hidden by clicking on the white down arrow.

For integration and peak hold measurements, the RESET button can be used to reset the accumulated values.

Note: There are no controls on this screen.

MEASUREMENTS	Phase A	Phase B	Phase C	Total
FREQUENCY	60.00 Hz	60.00 Hz	60.00 Hz	
VOLTAGE L-N RMS (AC-DC)	0.49 V _{RMS}	0.44 V _{RMS}	0.69 V _{RMS}	
VOLTAGE L-N RMS (AC)	0.12 V _{RMS}	0.14 V _{RMS}	0.14 V _{RMS}	
VOLTAGE L-N THD	0.00 %	0.00 %	0.00 %	
VOLTAGE L-N DC	0.47 V _{DC}	-0.42 V _{DC}	-0.67 V _{DC}	
CURRENT RMS (AC-DC)	0.87 A _{RMS}	0.81 A _{RMS}	0.82 A _{RMS}	
CURRENT RMS (AC)	0.03 A _{RMS}	0.03 A _{RMS}	0.04 A _{RMS}	
CURRENT THD	0.00 %	0.00 %	0.00 %	
CURRENT DC	0.87 A _{DC}	0.81 A _{DC}	0.82 A _{DC}	
POWER	0.00 kW	0.00 kW	0.00 kW	0.00 kW
WATT-HOUR ON RESET	0.00 kWh	0.00 kWh	0.00 kWh	0.00 kWh
ELAPSED TIME				0s
APP POWER	0.00 kVA	0.00 kVA	0.00 kVA	0.00 kVA
POWER FACTOR ▼	0.00	0.00	0.00	
CURRENT PHASE SHIFT (φ)	0.00 Deg	0.00 Deg	0.00 Deg	
DISPLACEMENT FACTOR (COS(φ))	0.00	0.00	0.00	
DISTORTION FACTOR	0.00	0.00	0.00	
PEAK VOLTAGE L-N	0.80 V	-0.93 V	-1.12 V	
RECORDED PEAK VOLTAGE L-N RESET	5.10 V	-3.11 V	10.28 V	
CURRENT CF ▼	-	-	-	
PEAK CURRENT	0.93 A	0.89 A	0.92 A	
RECORDED PEAK CURRENT RESET	-	-	-	
	V _{AB}	V _{BC}	V _{CA}	
VOLTAGE L-L RMS (AC-DC)	0.99 V _{RMS}	0.28 V _{RMS}	1.21 V _{RMS}	
VOLTAGE L-L RMS (AC)	0.06 V _{RMS}	0.20 V _{RMS}	0.19 V _{RMS}	
VOLTAGE L-L DC	0.99 V _{DC}	0.20 V _{DC}	-1.19 V _{DC}	
PEAK VOLTAGE L-L	1.32 V	0.75 V	-1.79 V	
RECORDED PEAK VOLTAGE L-L RESET	5.24 V	-10.42 V	11.17 V	

10.8.2 Real-Time Plot

This measurement screens provides a strip-chart style graphical display for up to two measurement parameters, #1 and #2. The CONTROLS are allows selection of the desired parameter for each graph. Available choices are Voltage, Current and Power. Depending on phase mode, up to three phase values are displayed per chart.

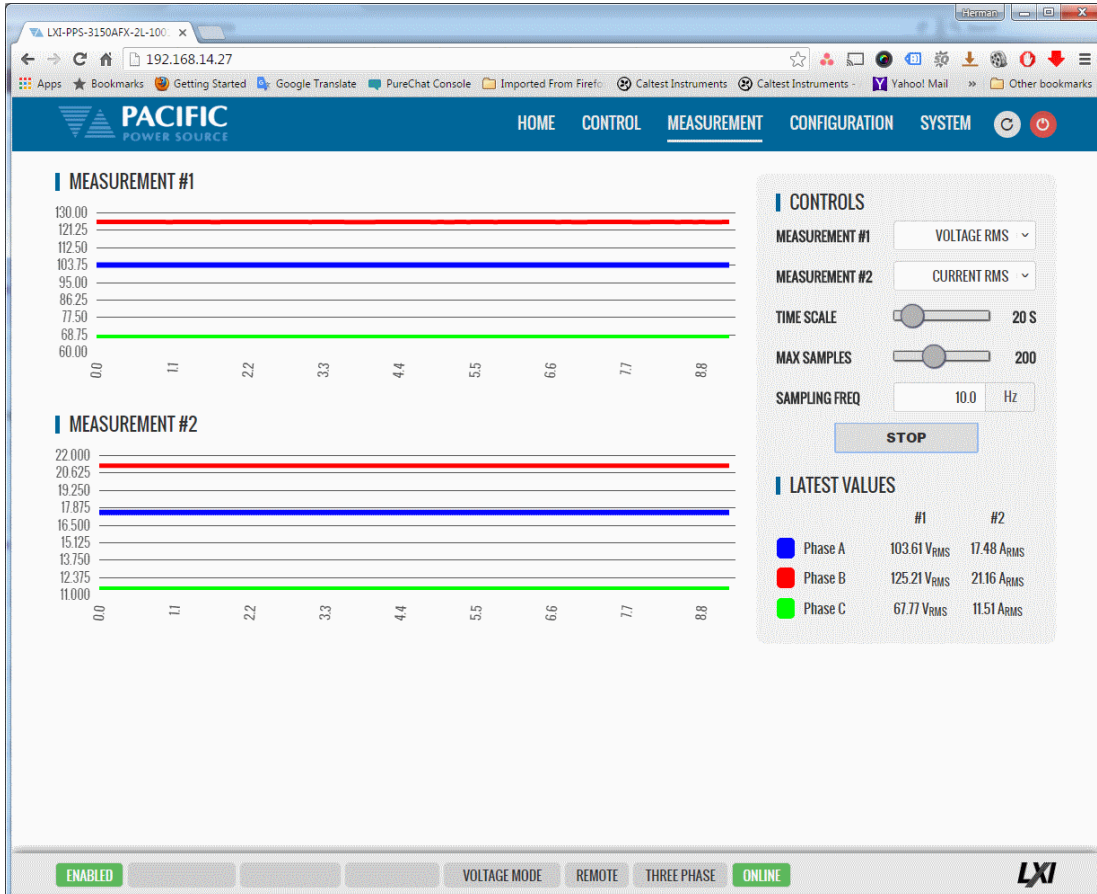

10.8.3 V/I Plot

The V/I plot shows the power operating point at any moment in time by plotting measured Voltage as a function of measured Current. This plot has a persistence mode so the user can observe power fluctuations and changes over a set period.

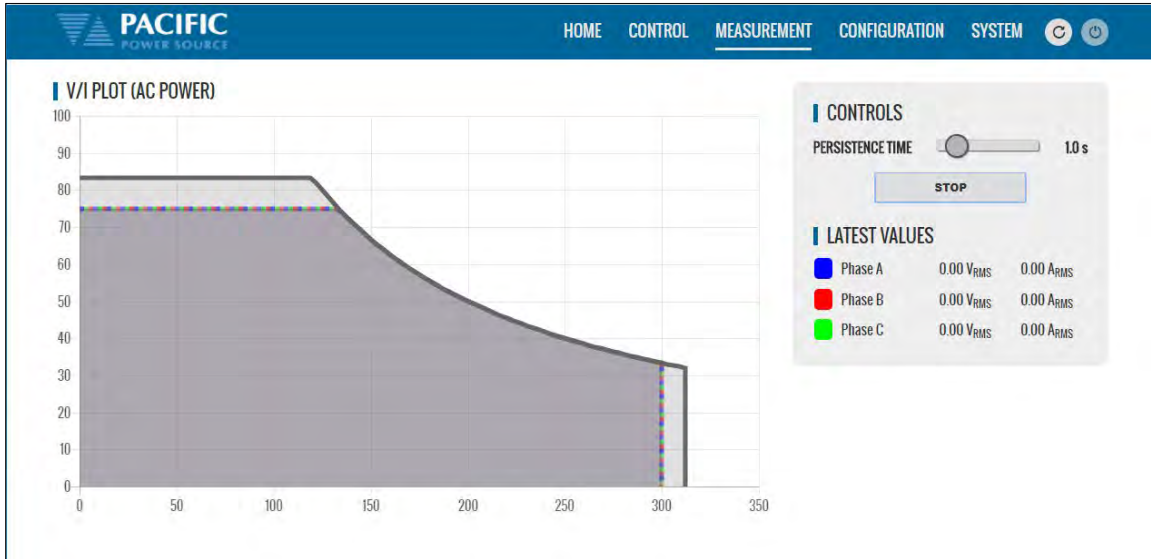

Available selections in this measurement screen are:

- Persistence Time: 1 ~ 60 sec

10.8.4 Data Logger

The measurement data logger screen allows measurement data to be written to a memory device, using a comma delimited file format. These files are easy to open in an Excel™ spreadsheet or other math oriented software program.

Available controls are for State on/off, memory destination device, file name assignment and data logging rate in Hz. All file entries are time stamped.

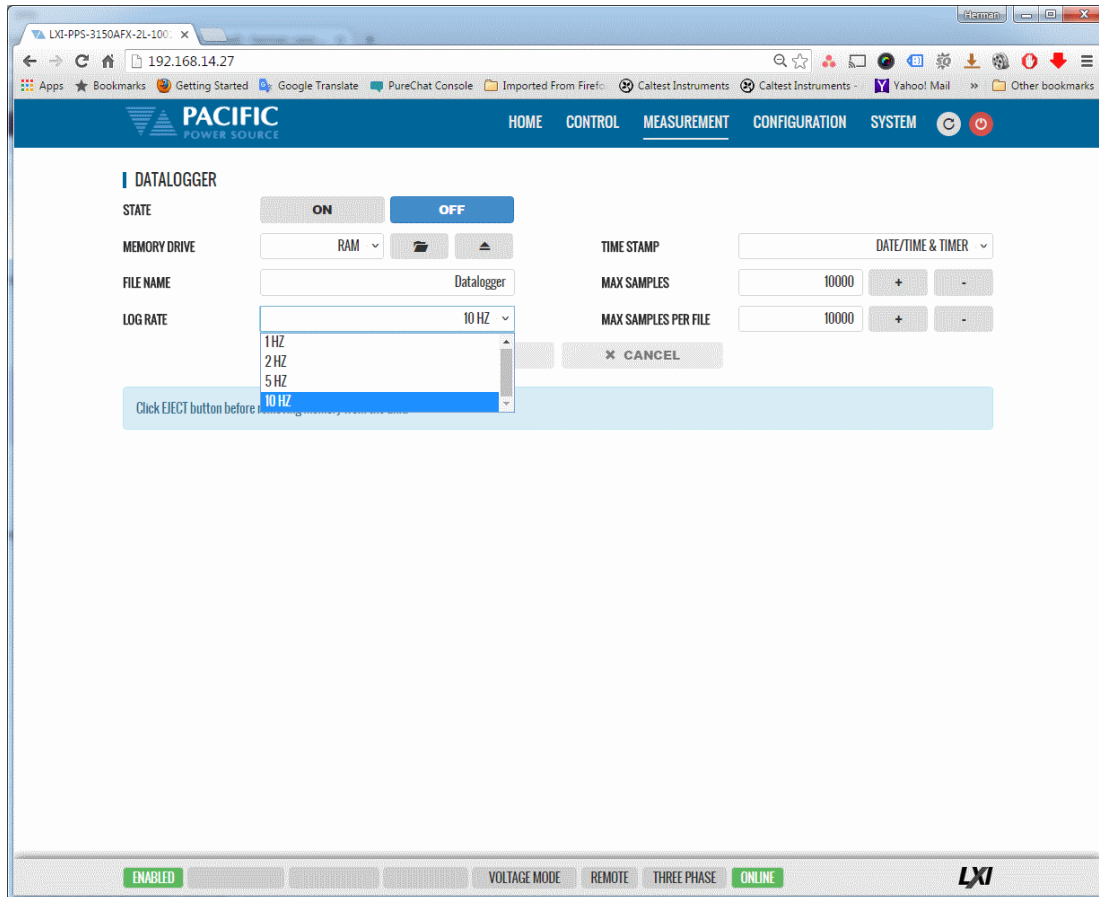

10.8.5 Scope Functions

There are two Scope Measurement screen with different levels of functionality. The Basic Scope function is most suitable to get a quick view of either voltage and or current waveforms on one of more output phase. The Advanced scope function offers many more settings, memory depth, programmable capture settings and trigger capabilities at the cost of have to set up more parameters to get the data you want.

10.8.5.1 Scope - Basic

The Scope function captures voltage and current waveforms at the output of the power source on all phases. This screen allows a variety of captured waveforms to be displayed.



The following controls are available to customize the captured waveform display:

CONTROL	Purpose
MEASUREMENT	Selects Voltage L-N, Voltage L-L, Current or Both Voltage & Current
PHASE	Selects Phase A, B, C or all (ABC). Only visible in two or three phase mode.
TIME UNIT	Selects time scale in either TIME, SAMPLES or PHASE
PERIODS	Selects the number of periods to display. Range is 1~ 4
AUTO REFRESH	Turns AUTO REFRESH mode ON or OFF
REFRESH PERIOD	Sets interval time for AUTO REFRESH mode in seconds. Range is 5 ~ 100.
REFRESH	Manual REFRESH button
EXPORT GRAPH	Downloads image for displayed waveform(s). See sample below.
EXPORT DATA	Downloads captured data points for displayed waveform(s) in csv format text file. See sample below.

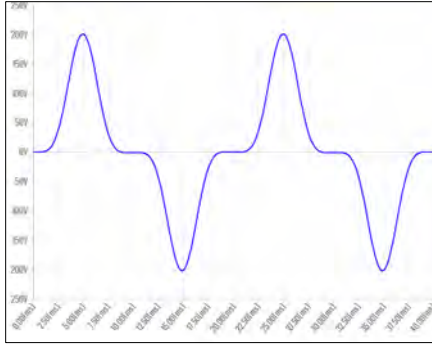

Sample	Degrees	Time[s]	Phase A - Voltage[V]
1	0	0	-0.12
2	0.7	3.91E-05	0.05
3	1.41	7.81E-05	0.02
4	2.11	0.000117	-0.1
5	2.81	0.000156	-0.03
6	3.52	0.000195	0

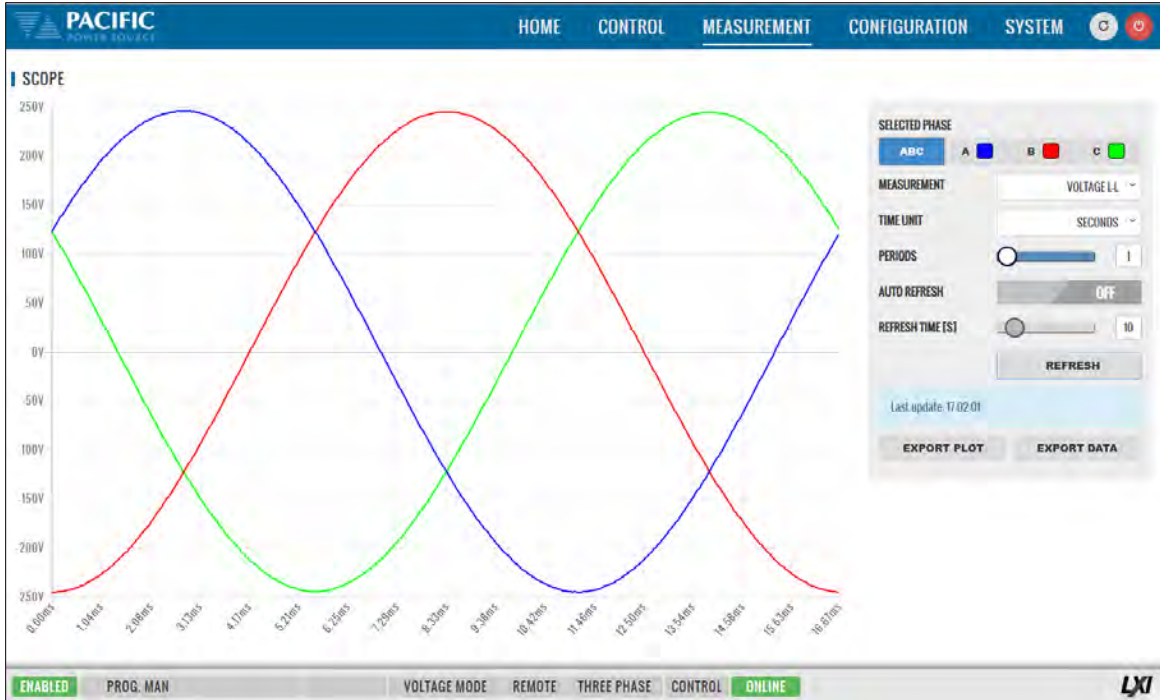

Line to Line capture for all phases.

Voltage and Current can be displayed in one scope screen:

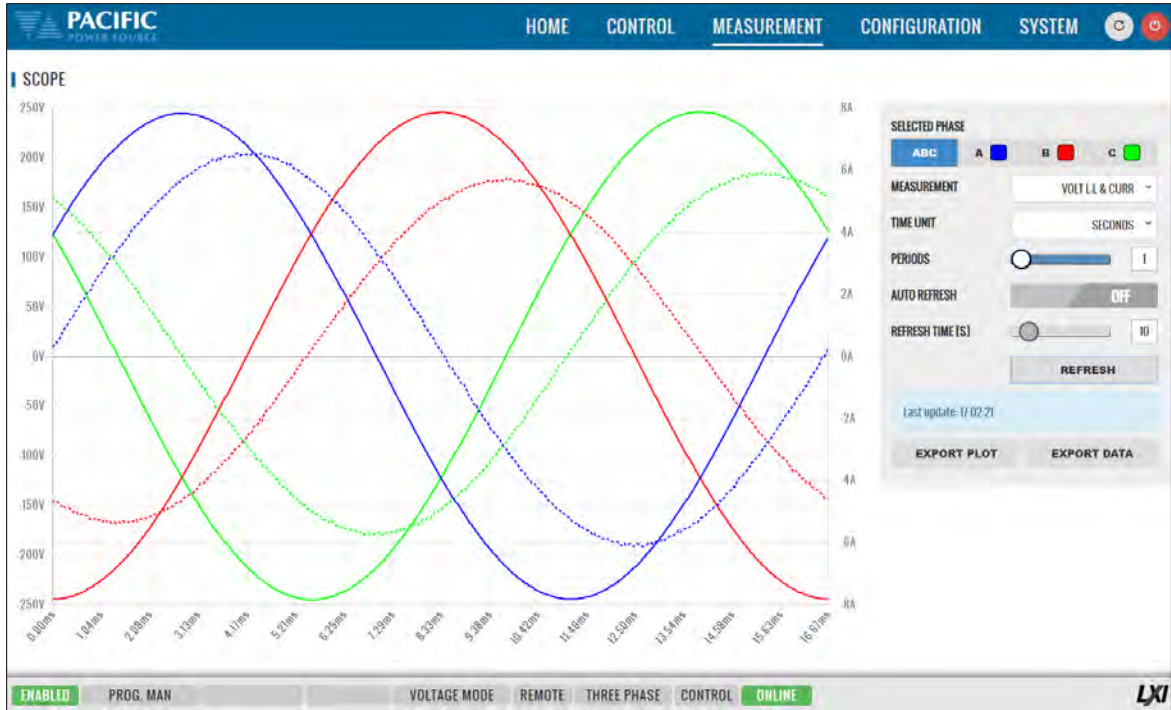



10.8.5.2 Scope – Advanced

The ADVANCED scope function operates much the same as a digital storage oscilloscope having controls for time base, attenuators and trigger mode settings. The amount of data points that can be captured and stored ranges from 100 Samples to 1,000,000 samples (1Ms).

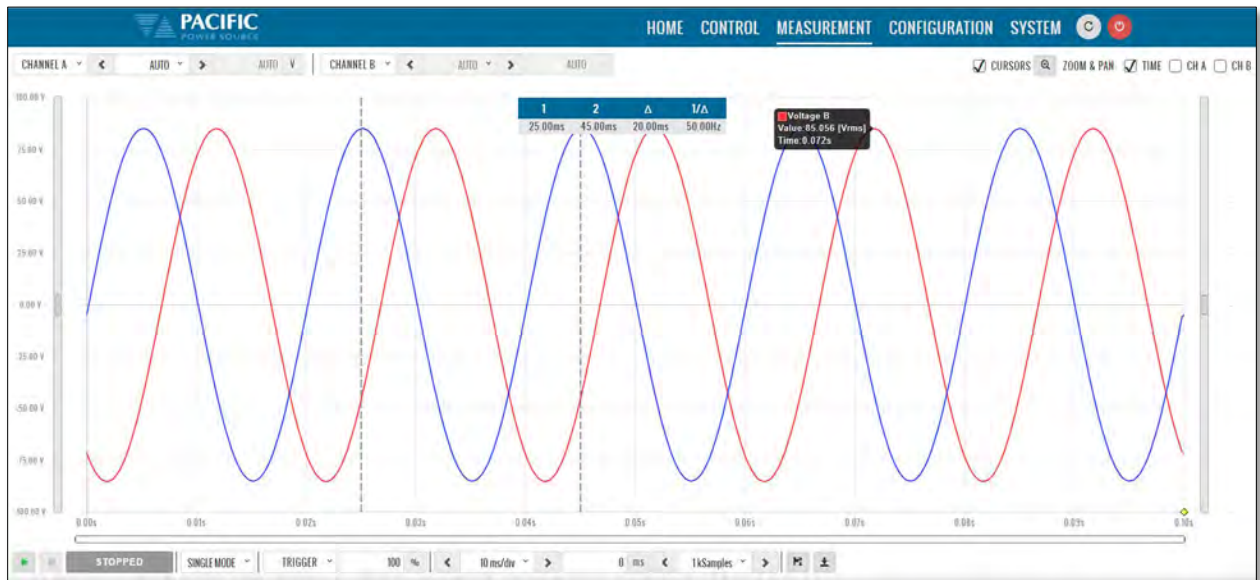
The advanced scope function has two channel, labeled CHANNEL A and CHANNEL B. Each channel can be assigned to capture either voltage or current on any of the available output phases. Vertical scaling can be set as well as DC offset for each channel as needed.

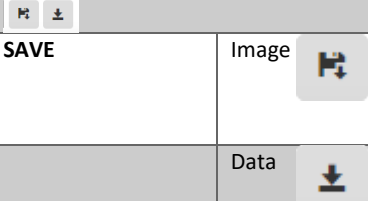

Settings and ranges are detailed in the table bellows.

CONTROL		Purpose
		
CHANNEL A	Input	Selects output phase and parameter to be captured on Channel A. Available phase vary by model: (Phase A for Single phase, Phase A or B in Split phase, Phase A, B or C in Three phase mode.
	Attenuator	Sets input amplitude scaling from 1V/div to 200V/div. Also available is AUTO scaling or channel OFF.
	DC Offset	This setting sets DC Offset or AUTO for auto DC offset compensation.
CHANNEL B		Same as Channel A but for B Channel
		
CURSORS	Check	Check ON to display on screen cursors. When Enabled, two cursors are displayed using dashed vertical lines. Cursors are 1 and 2. Also shown is delta- T and 1/delta T. Use the mouse or touch screen to move the cursors.
	Zoom & Pan	Available selections are: <ul style="list-style-type: none"> • Time • CH A • CH B
		
RUN / STOP	Acquisition	The Green Run button is location in the lower left corner. A Stop button is located right next to it. The Stop button will be enabled while an acquisition is in progress. The acquisition status is shown to the right of the Stop button as either: <ul style="list-style-type: none"> • RUNNING • WAITING TRIGGER • STOPPED
	Acq. Mode	Available selections are SINGLE MODE or REPEAT MODE
TRIGGER	Trigger Modes	Available Trigger mode selections are: <ul style="list-style-type: none"> • UPDATE PHASE CROSSING • OUTPUT ENABLE • OUTPUT DISABLE • FREQUENCY CHANGE • VOLTAGE RMS CHANGE • VOLTAGE DC CHANGE • PHASE CHANGE • WAVEFORM CHANGE • INTERHARMONIC CHANGE
	Position	The trigger position can be set from 0% of vertical scale (left) to 100% of vertical scale (right). The trigger position is indicated using a yellow diamond on the time axis.
TIME BASE	Time/div	Available time base settings range from 10 sec/div to 20 µsec/div. The acquisition window is a function of this setting and the selected sample window size.
OFFSET	Trigger Offset	Trigger offset time and be set from 0 msec to 99,999,999,999,999,980,000 msec
MEMORY DEPTH	No of Samples	No samples acquires can be set from 100 Samples to 1M Samples
		
SAVE	Image	Saves Scope Image to PNG image file. Destination is browser default download directory. Note: Only the waveform display area of the browser window is saved. To save the entire screen, including all scope settings, use a screen capture utility instead.
	Data	Saves scope data to CSV File. Destination is browser default download directory.

10.8.6 Harmonics Measurements

There are two Harmonics measurement screens. One is a basic harmonic bar chart display. The other is a more Advanced Spectrum display.

10.8.6.1 Basic Harmonics Measurement Screen

Harmonics measurements for voltage and current on all phases can be displayed using the Harmonics display screen as illustrated below. Both Bar Chart and Table displays are shown. The distortion values for the parameter selected (Voltage or Current) are display in a table directly below the Bar chart area.

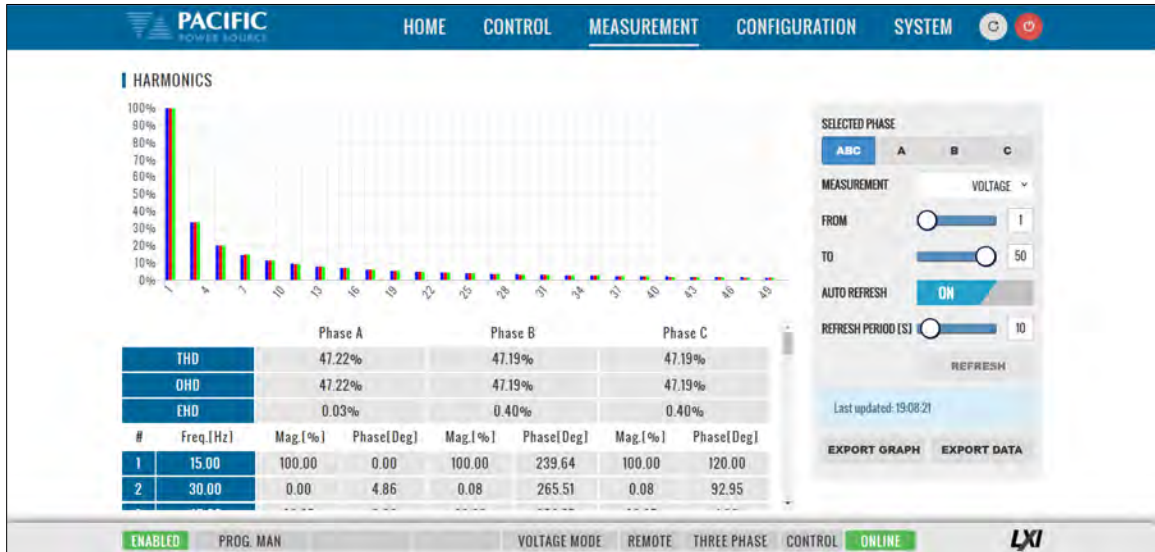

Available selections in this measurement screen are:

CONTROL	Purpose
SELECTED PHASE	
MEASUREMENT TYPE	Selects Voltage L-N, Voltage L-L, Current or Both Voltage & Current
FROM	Selects the first harmonic number to display. Range is 1 ~ 49
TO	Selects the last harmonic number to display. Range is 2 ~ 50
AUTO REFRESH	Turns AUTO REFRESH mode ON or OFF
REFRESH PERIOD	Sets interval time for AUTO REFRESH mode in seconds. Range is 5 ~ 100.
REFRESH	Manual REFRESH button
EXPORT GRAPH	Downloads image for displayed Bar chart. See sample below.
EXPORT DATA	Downloads captured harmonics data in csv format text file. See sample below.

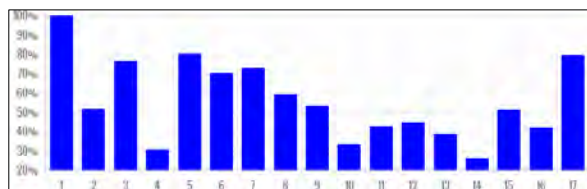

Measurement	Phase A[%]		
THD	455.98		
OHD	354.89		
EHD	286.32		
#	Freq.[Hz]	Phase A Mag.[%]	Phase A Phase.[Deg]
1	50	100	75.89
2	100	51.72	60.61
3	150	76.38	70.94
4	200	30.75	329.44
5	250	80.49	243.12
6	300	70.33	18.6

10.8.6.2 Advanced Spectrum Measurement Screen

The Harmonics Spectrum display expands on the basic harmonics display by adding a Vector diagram and a Time Domain (Scope) representation of the voltage or current for all phases

A sample screen is shown below.

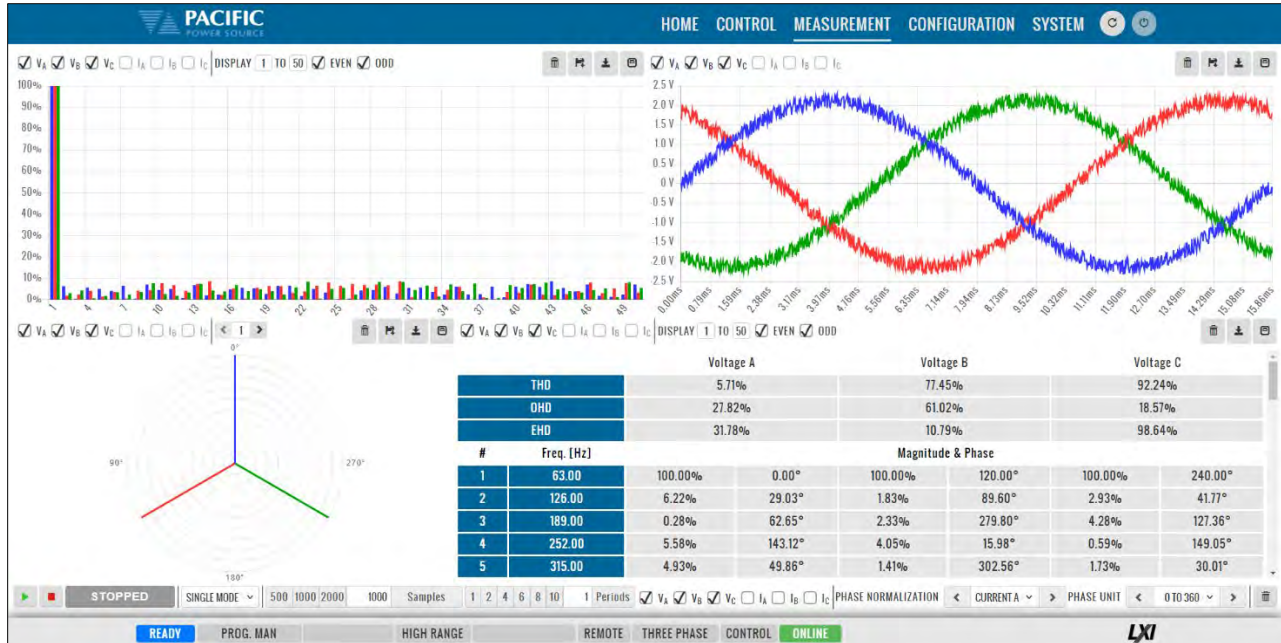

Available selections in this measurement screen are:

CONTROL	Purpose
BAR CHART (upper left)	
VOLT PHASE SELECT	Select VA, VB, Vc or any combination thereof.
CURRENT PHASE SELECT	Select IA, IB, IC or any combination thereof.
DISPLAY	Selects harmonics range display from 1 to 50 and EVEN, ODD or both.
SCOPE SCREEN (upper right)	
VOLT PHASE SELECT	Select VA, VB, Vc or any combination thereof.
CURRENT PHASE SELECT	Select IA, IB, IC or any combination thereof.
DISPLAY	Selects harmonics range display from 1 to 50 and EVEN, ODD or both.
PHASOR DIAGRAM (Lower left)	
VOLT PHASE SELECT	Select VA, VB, Vc or any combination thereof.
CURRENT PHASE SELECT	Select IA, IB, IC or any combination thereof.
HARMONIC NUMBER	Select on from 1 through 50 using left/right arrows.
HARMONICS TABLE (Lower right)	
VOLT PHASE SELECT	Select VA, VB, Vc or any combination thereof.
CURRENT PHASE SELECT	Select IA, IB, IC or any combination thereof.
CONTROL MENU (Bottom)	
START / STOP	Green Arrow Starts, Red Square Stops acquisition
Status Display	RUNNING / STOPPED
No of Sampes	Select from 500, 1000 or 2000
No of Periods	Select from 1, 2, 4, 6, 8 or 10
Phase Normalization	Select Current or Voltage and Phase
Phase Unit	Either degrees (0-360) or time.

10.9 Configuration Screens

The CONFIGURATION menu provides access to secondary power source settings that are less frequently changed than those on the PROGRAM screen. Configuration screens available are:

- UNIT SETTINGS
- USER LIMITS & PRESETS
- RAMP & SLEW

Each is described in subsequent sections.

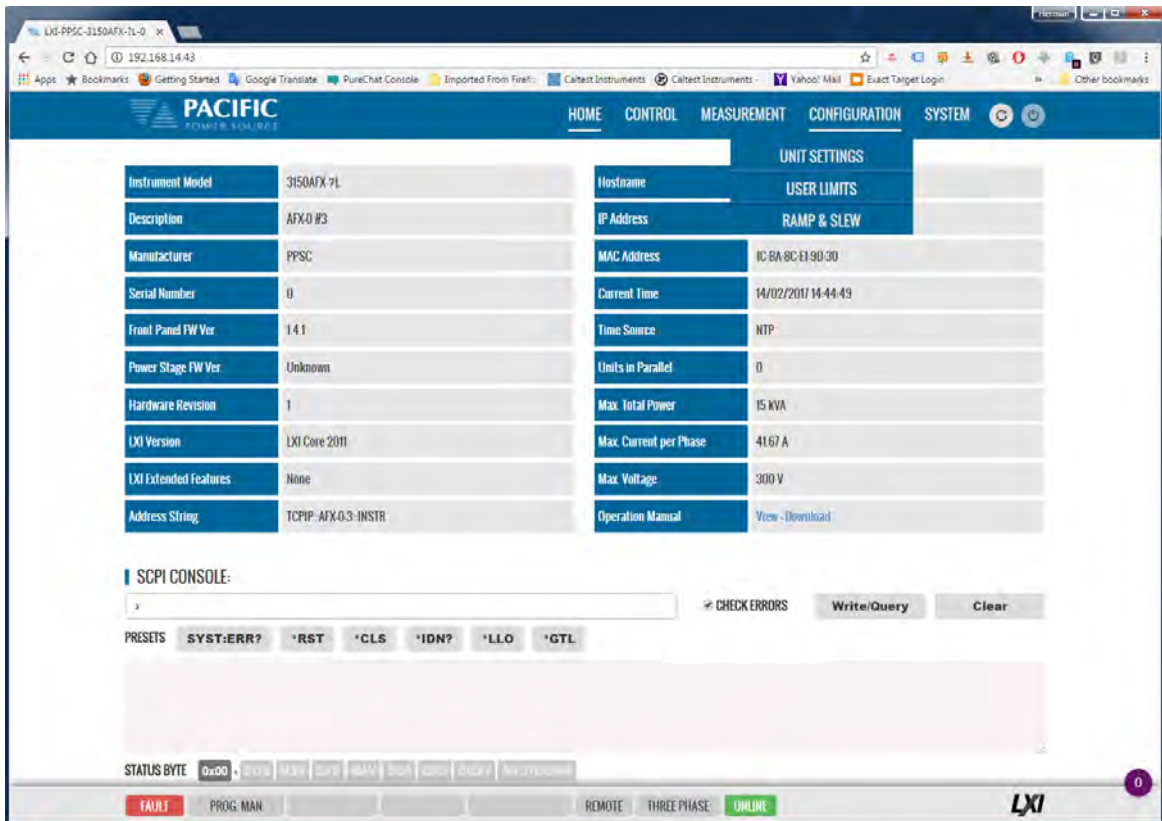

10.9.1 Unit Settings

Unit settings determine the mode of operation of the unit.

Three modes of operation are available:

- Voltage Source
- Current Source
- Active Load (Requires Option L)

The setting screen is different for each mode of operation

10.9.1.1 Voltage Source Setting Screen

This includes phase mode, voltage range, output mode, and update phase angle and ramp time for any output value changes made.

- Output enable at power on allows the unit to power up with the output enabled.
- Phase Rotation selection changes output phasing between positive (leading) and negative (lagging) phase rotation in three phase output mode.
- The maximum adjustment limit for continuous self-calibration mode and fault generation on saturation can be set from this screen as well.
- The right hand side of the screen contains Transient mode execution settings.
- Language selections are either ENGLISH or CHINESE.

These can all be set from the CONFIGURATION -> UNIT SETTINGS screen shown below.

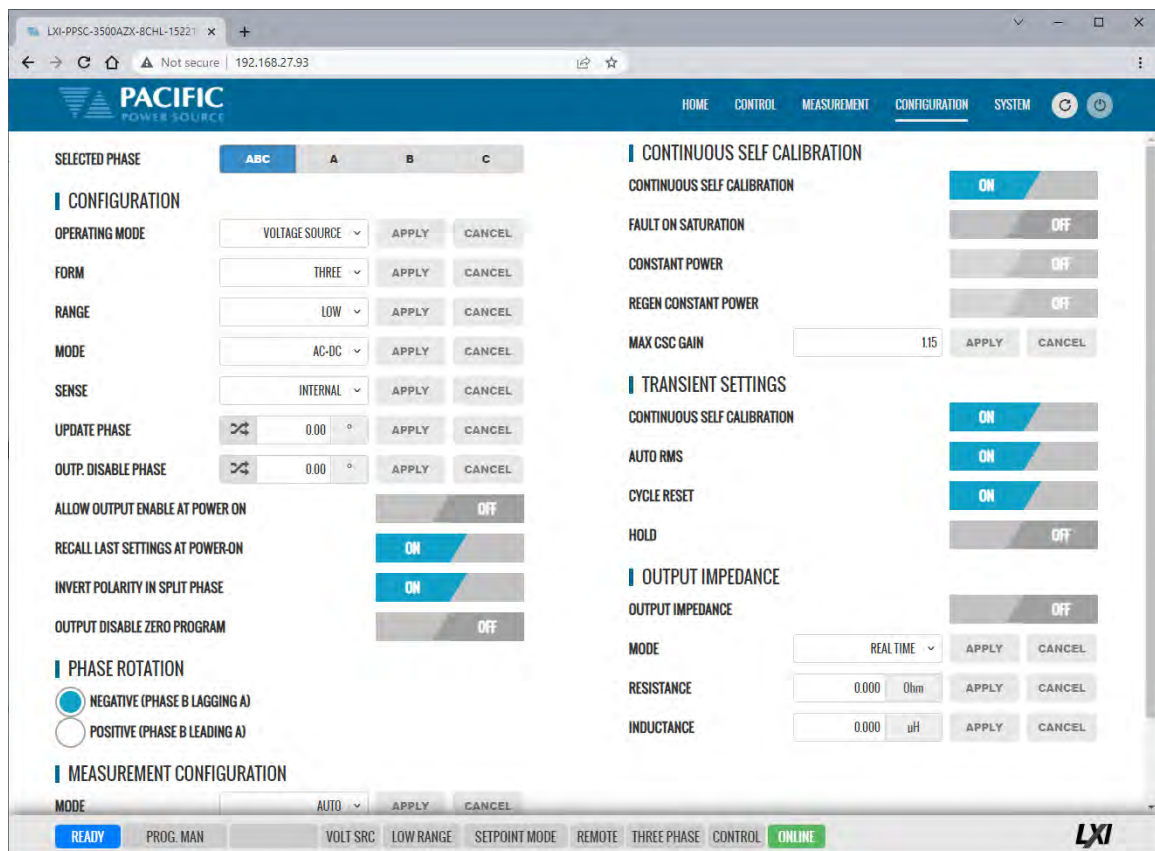

10.9.1.2 Current Source Setting Screen

In current source mode, settings are similar to Voltage mode but current is programmable, both for AC and DC, rather than voltage.

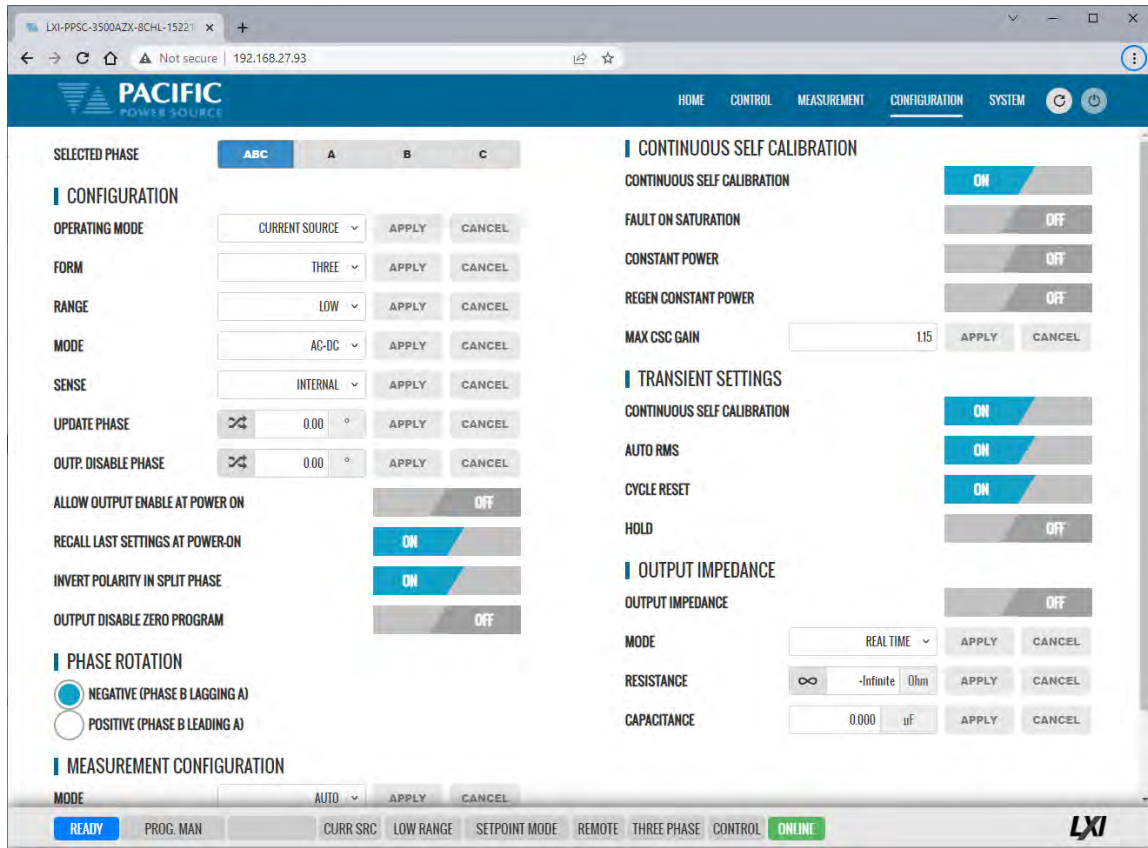

10.9.1.3 Active Load Setting Screen – Constant Current

In electronic load mode, the current and power are a function of the input voltage sensed at the input terminals A, B, C, N. Load mode requires syncing to the sensed input voltage to allow synchronization of the current to the input voltage and phase shift programming.

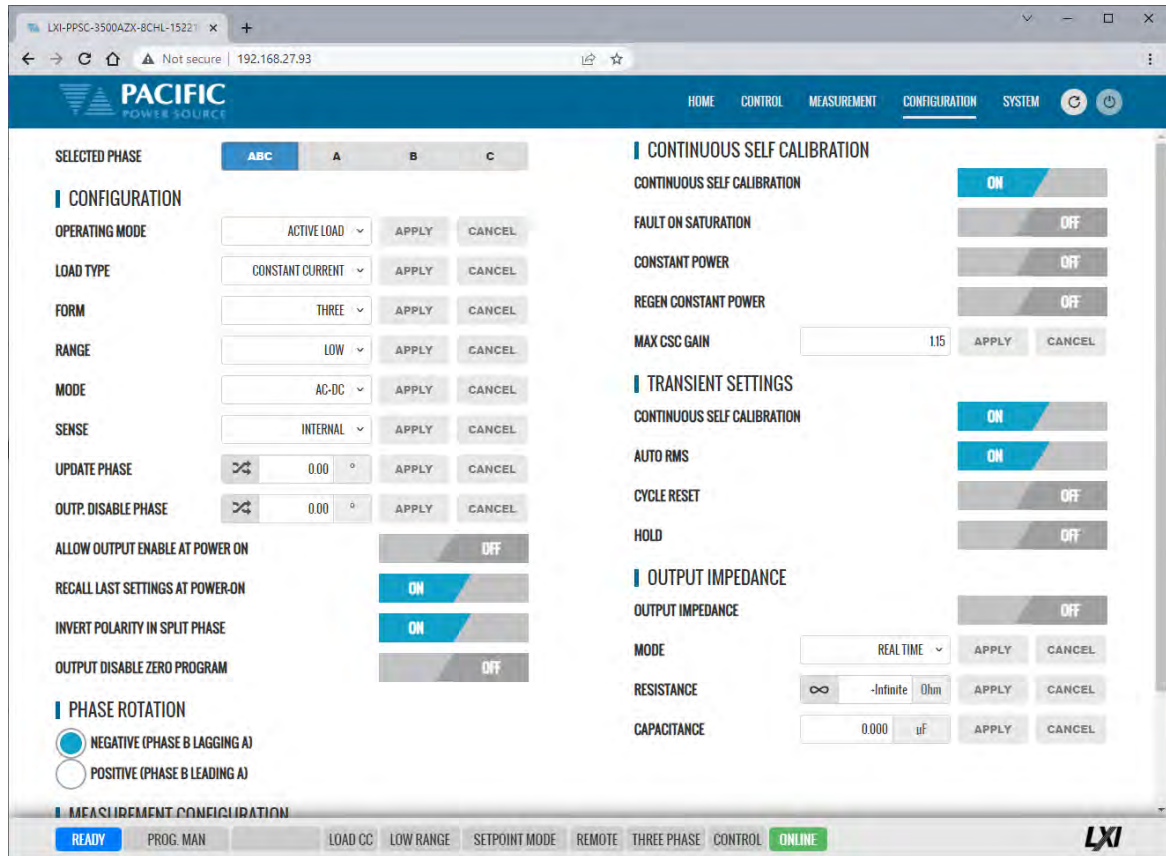

10.9.1.4 Active Load Setting Screen – Constant Impedance

In electronic load mode, the current and power are a function by the input voltage sensed at the input terminals A, B, C, N. Since the input voltage can be AC and or DC, the MODE in Impedance Load mode is always AC+DC. The resistance value can be programmed by the user in the Control -> Program screen of the browser.

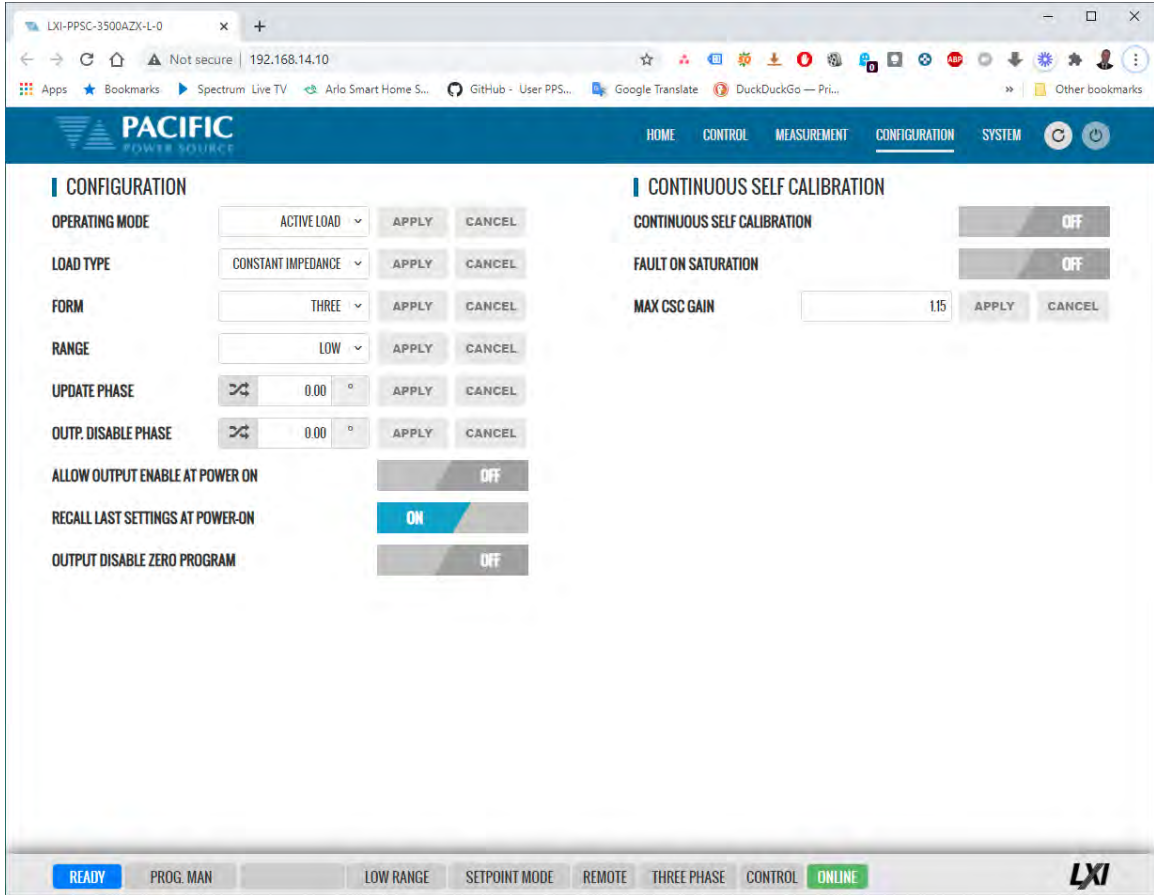

10.9.2 User Limits & Presets

User limits can be used to minimize operator error by setting upper and/or lower limits on programmable parameter ranges.

Limits can be set for Voltage AC, Voltage DC and Frequency.

Note: When changing user limits, make sure programmed parameter settings in effect are not outside the new upper and lower limits entered.

All user limits can be set from the CONFIGURATION -> USER LIMITS& PRESETS screen shown below.

Extended range for voltage and frequency may be selected as needed. Some restrictions apply when operating in extended range mode.

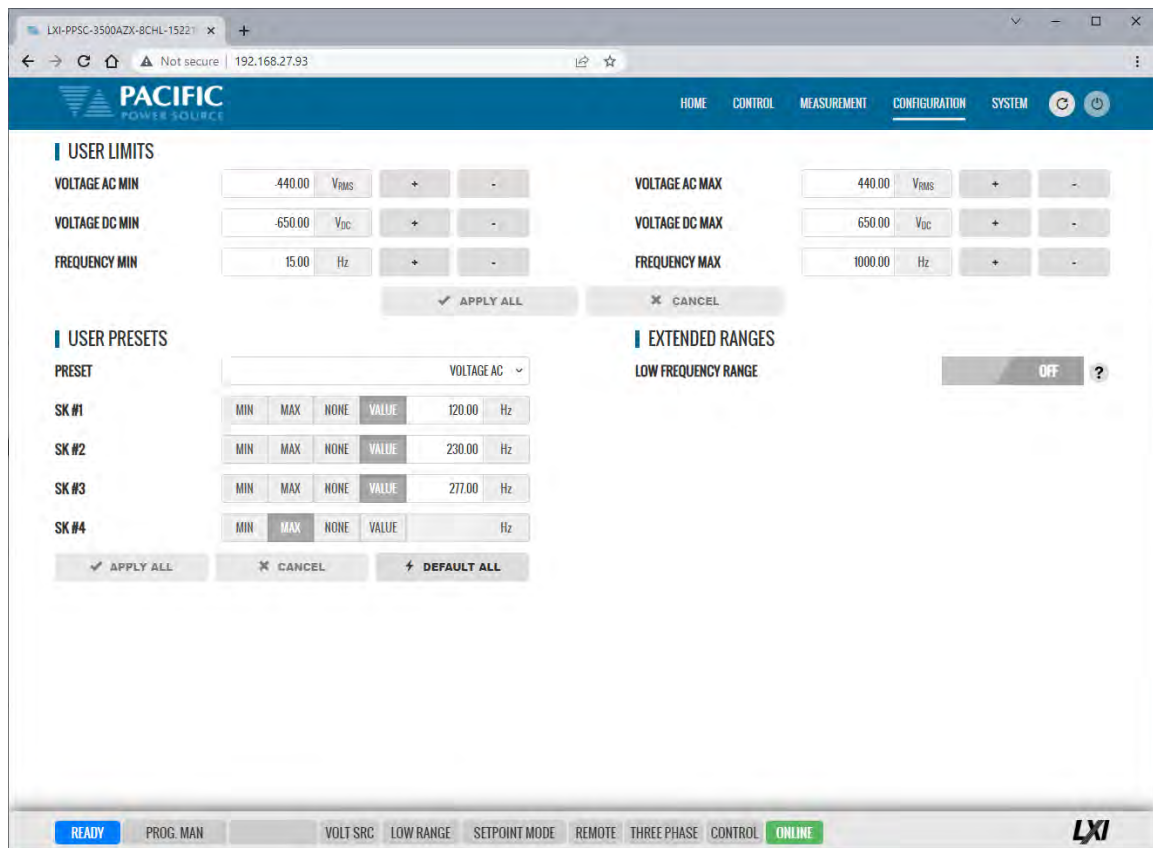

User programmable presets can be set to define the set values of the Soft keys in the program screens. This allows commonly used setting values to be selected by an operator by just pressing a single soft key. See image above for samples.

10.9.3 Ramp Time & Slew Rate

The Slew Rate screen has entries for all available programmable slew rate settings. This includes real time voltage, Voltage AC RMS, Voltage DC, Frequency and Phase Angle. Note that both are mutually exclusive as they would conflict with each other. To use programmable slew rates, the RAMP TIME must be disabled.

Slew Rates can be set for Voltage AC, Voltage DC and Frequency.

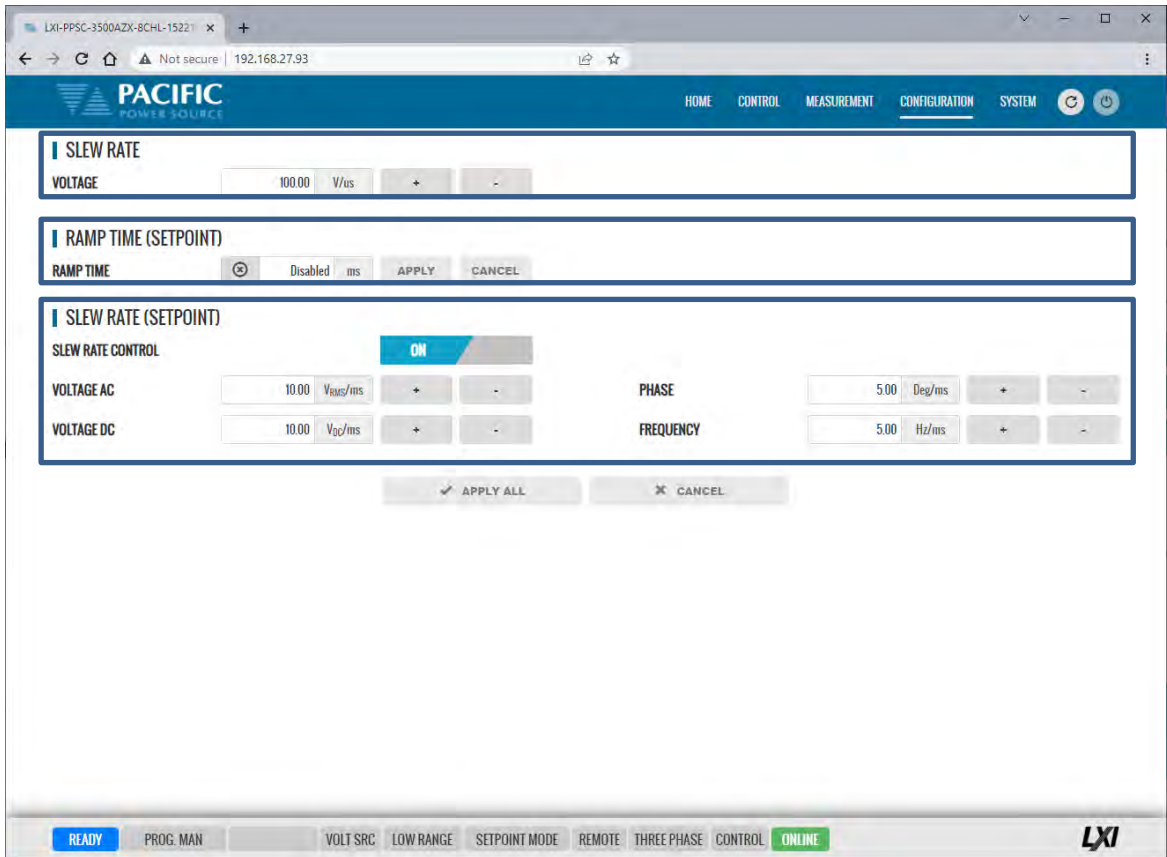

10.10 System Screens

The SYSTEM menu provides access to system level settings. System setting screens available are:

- ERROR/EVENT QUEUE
- FAULT LIST
- ERROR/EVENT LIST
- INTERFACE SETUP
- ACCESS CONTROL
- DIGITAL & ANALOG IOs
- REMOTE INTERFACE
- UNIT INFORMATION
- CONNECTED UNITS (aka PARALLEL UNITS)
- MEMORY BROWSER
- CALIBRATION
- REMOTE SUPPORT
- IMPORT/EXPORT
- FIRMWARE UPDATE
- SANITIZE & REBOOT

Each is described in subsequent sections.

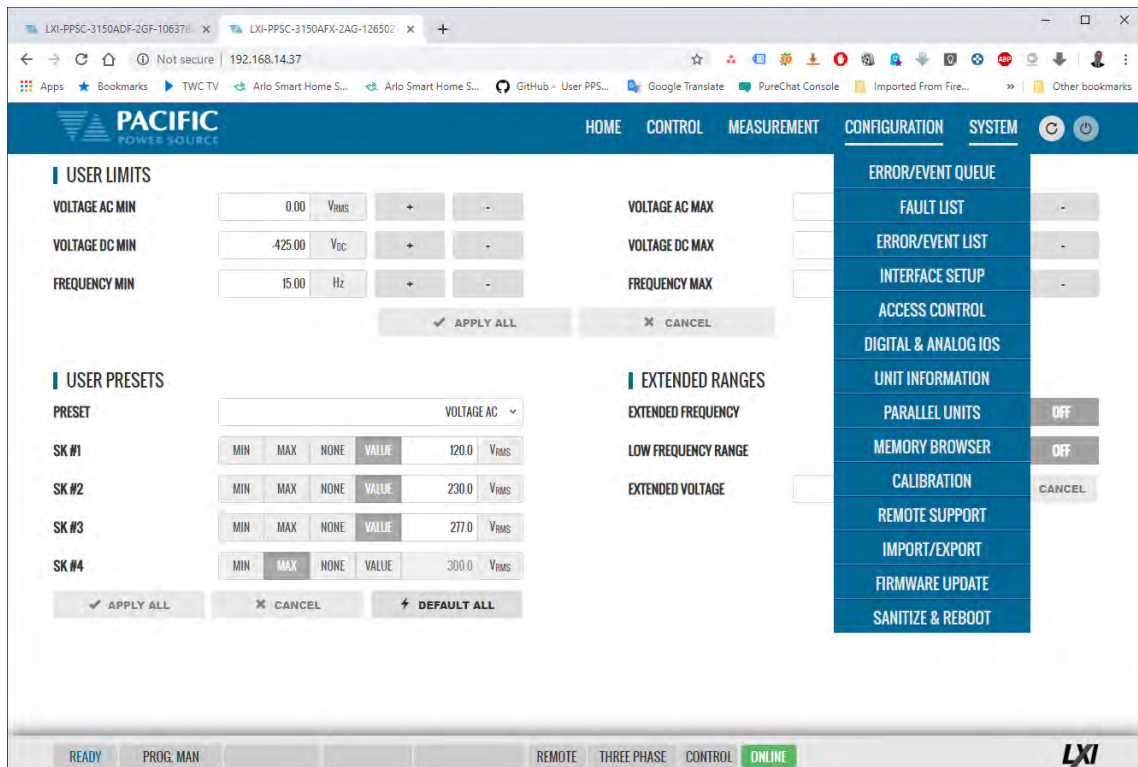

10.10.1 Error/Event Queue

The Error and Event Queue tracks internal errors or communication errors that may occur during normal user. Generally, such errors are the results of programming conflicts or setting conflicts and are no cause for concern. Other events may be normal, such as a power-on event and will be recorded in the same queue. The user can clear the queue at any time using the

CLEAR QUEUE button.

Actual hardware faults are tracked in the FAULT queue. See next section.

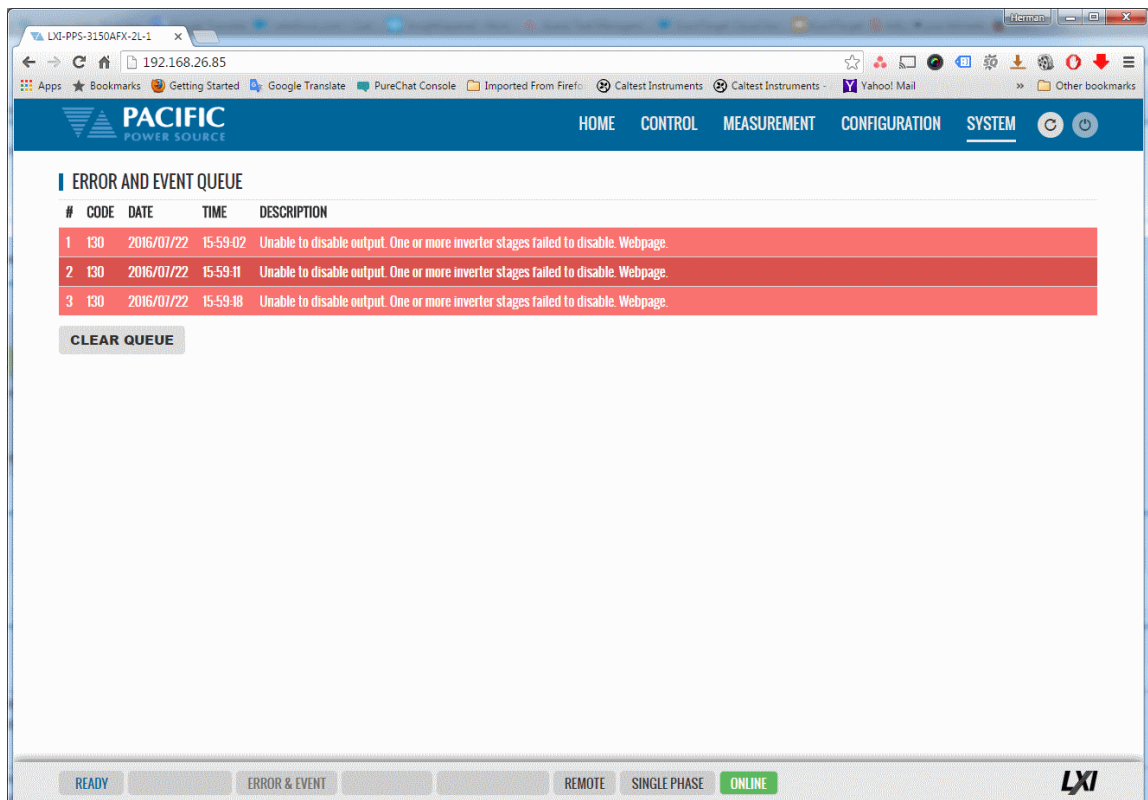

10.10.2 Fault List

The Fault List tracks hardware faults that may occur in the power conversion stages. This information may be useful for PPS engineering staff.

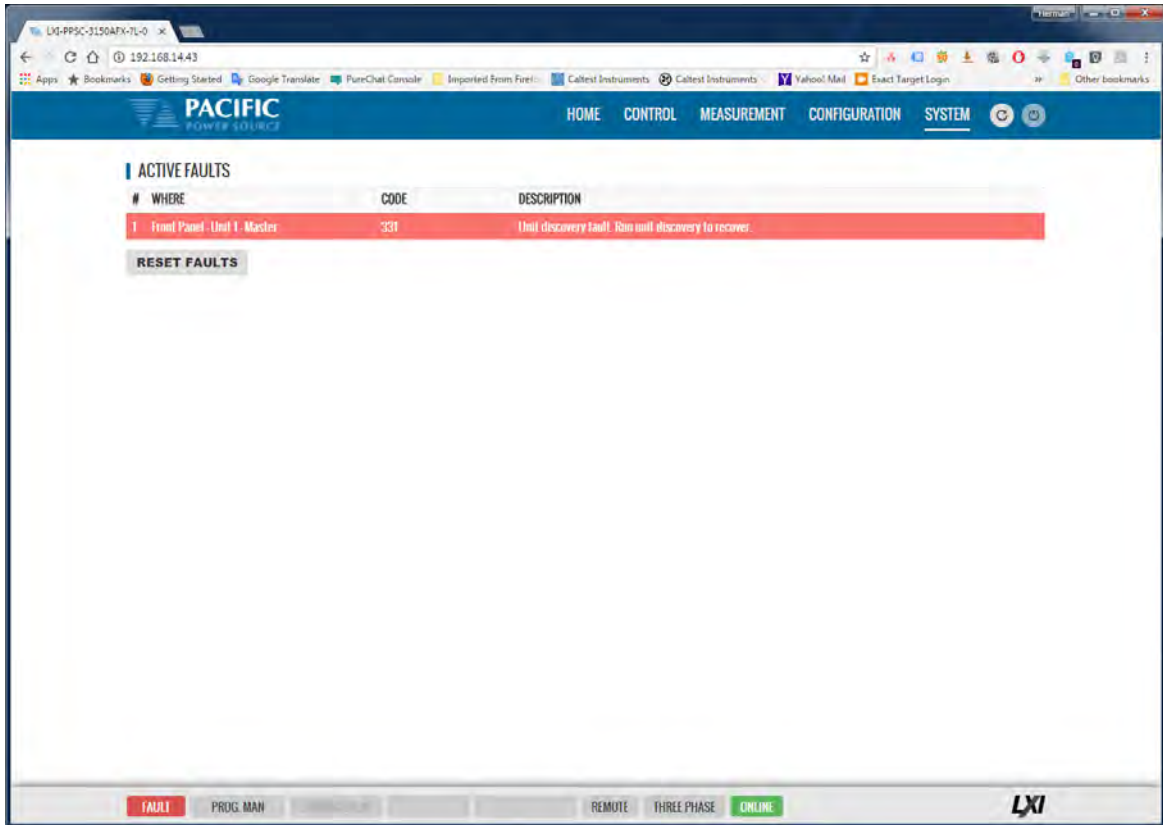

10.10.3 Error/Event List

The Error Event list provides a complete listing of all possible error and event messages. The description may include possible troubleshooting hints to resolve any error conditions.

Errors are listed in numerical order.

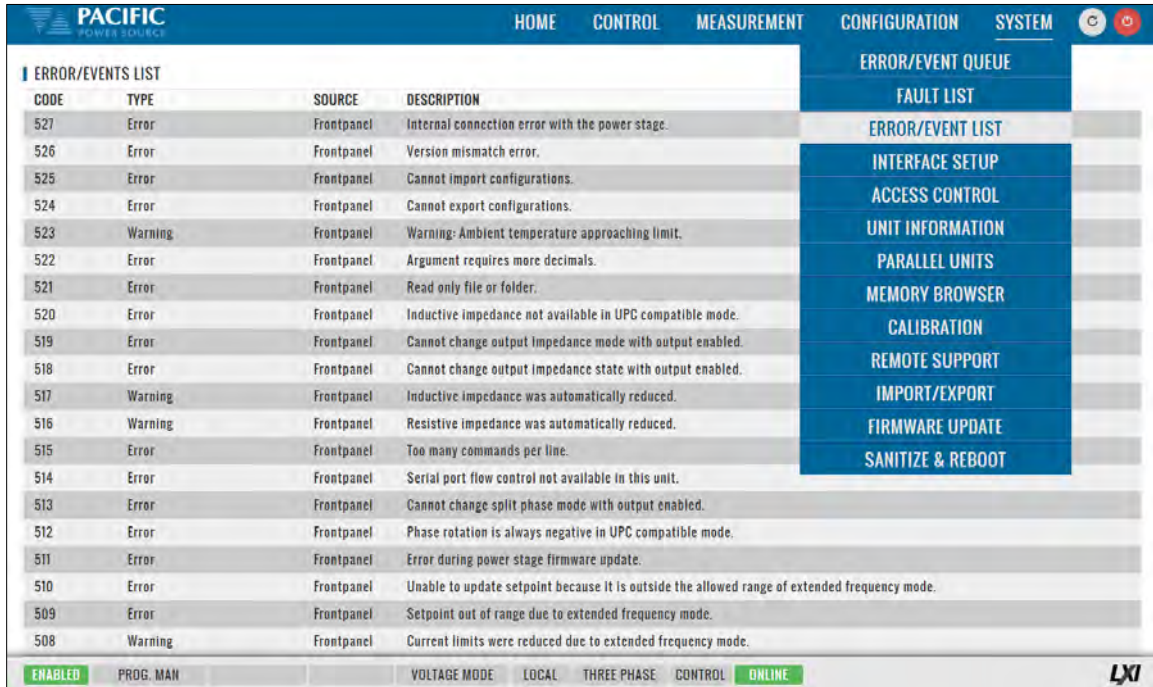

The screenshot shows the Pacific Power Source web interface. The top navigation bar includes 'HOME', 'CONTROL', 'MEASUREMENT', 'CONFIGURATION', and 'SYSTEM'. The 'SYSTEM' menu is expanded, showing options like 'ERROR/EVENT QUEUE', 'FAULT LIST', 'ERROR/EVENT LIST', 'INTERFACE SETUP', 'ACCESS CONTROL', 'UNIT INFORMATION', 'PARALLEL UNITS', 'MEMORY BROWSER', 'CALIBRATION', 'REMOTE SUPPORT', 'IMPORT/EXPORT', 'FIRMWARE UPDATE', and 'SANITIZE & REBOOT'. The 'ERROR/EVENT LIST' is selected, displaying a table of error and event messages.

CODE	TYPE	SOURCE	DESCRIPTION
527	Error	Frontpanel	Internal connection error with the power stage.
526	Error	Frontpanel	Version mismatch error.
525	Error	Frontpanel	Cannot import configurations.
524	Error	Frontpanel	Cannot export configurations.
523	Warning	Frontpanel	Warning: Ambient temperature approaching limit.
522	Error	Frontpanel	Argument requires more decimals.
521	Error	Frontpanel	Read only file or folder.
520	Error	Frontpanel	Inductive impedance not available in UPC compatible mode.
519	Error	Frontpanel	Cannot change output impedance mode with output enabled.
518	Error	Frontpanel	Cannot change output impedance state with output enabled.
517	Warning	Frontpanel	Inductive impedance was automatically reduced.
516	Warning	Frontpanel	Resistive impedance was automatically reduced.
515	Error	Frontpanel	Too many commands per line.
514	Error	Frontpanel	Serial port flow control not available in this unit.
513	Error	Frontpanel	Cannot change split phase mode with output enabled.
512	Error	Frontpanel	Phase rotation is always negative in UPC compatible mode.
511	Error	Frontpanel	Error during power stage firmware update.
510	Error	Frontpanel	Unable to update setpoint because it is outside the allowed range of extended frequency mode.
509	Error	Frontpanel	Setpoint out of range due to extended frequency mode.
508	Warning	Frontpanel	Current limits were reduced due to extended frequency mode.

At the bottom of the interface, there are status indicators: 'ENABLED', 'PRG. MAN', 'VOLTAGE MODE', 'LOCAL', 'THREE PHASE', 'CONTROL', and 'ONLINE'. The 'LXI' logo is visible in the bottom right corner.

10.10.4 Interface Setup

The Interface setup screen allows enabling or disabling of several available interfaces and operating modes. The interfaces are arranged by type:

- LAN
- USB
- RS232 Serial
- GPIB (Note: on A version AZX Models only)

Interfaces that are not used can be turned off to avoid conflicts caused by multiple active interfaces at the user's discretion.

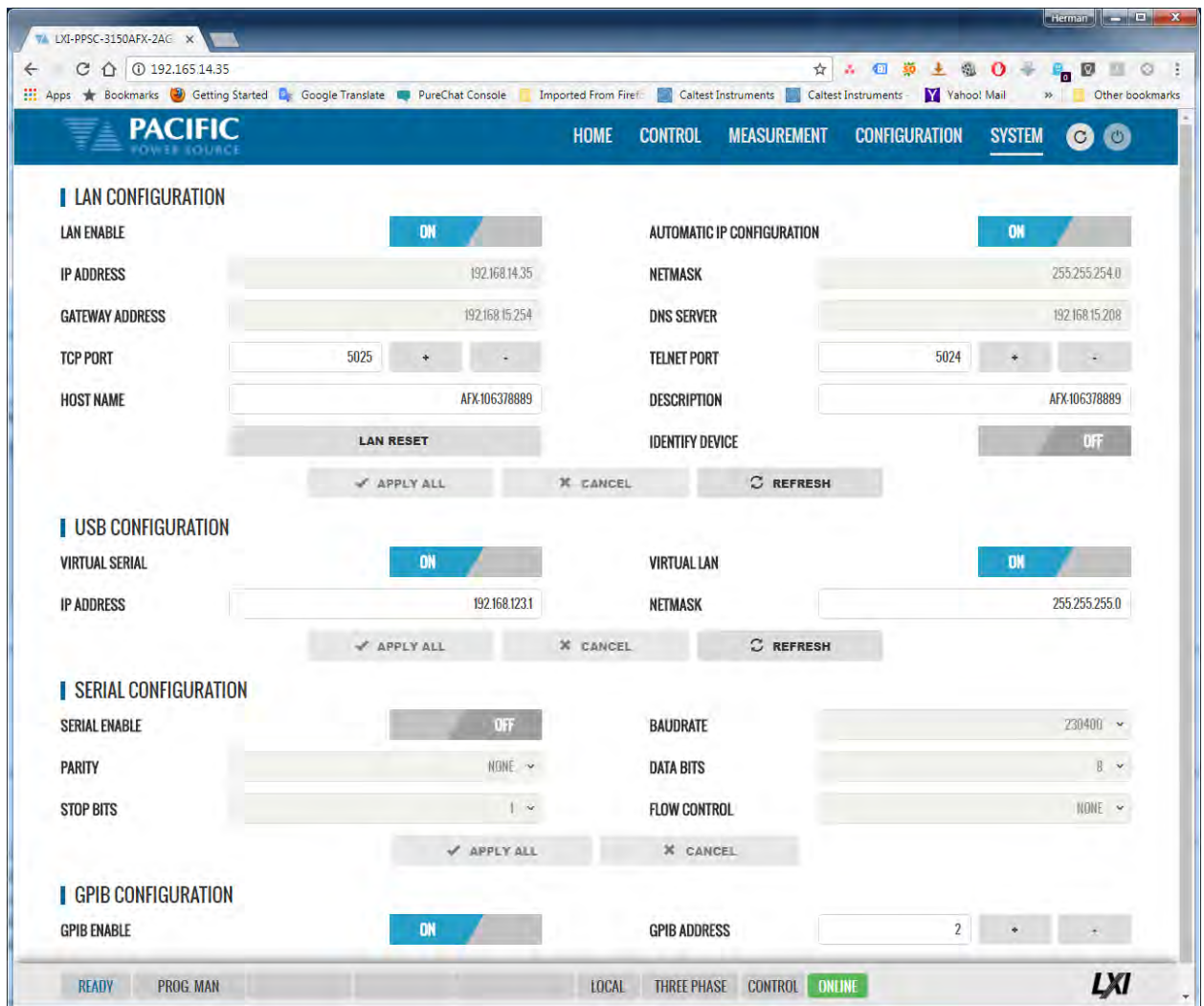

10.10.5 Access Control

The access control screen allows restricting access to the power source over the LAN interface. This is an important requirement for power sources connected to a companywide Ethernet network. Without access restrictions, people not present where the power source is located could inadvertently cause a dangerous condition by either enabling the OUTPUT or changing programmed settings.

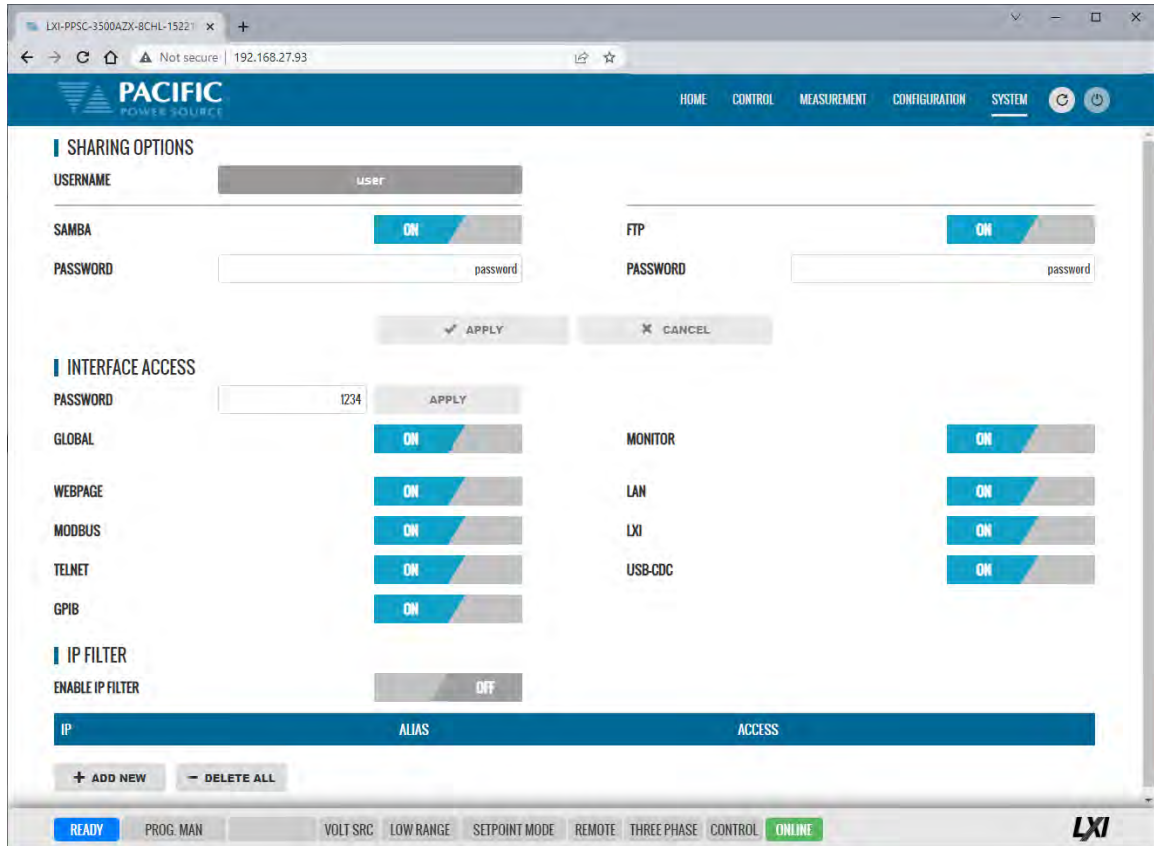

Access control can limit access from specific IP addresses only and requires someone physically present where the power source is to grant access to anyone else.

For more details, refer to section 10.3, “Access Control” on page 558 of this manual.



10.10.6 Digital & Analog IO's

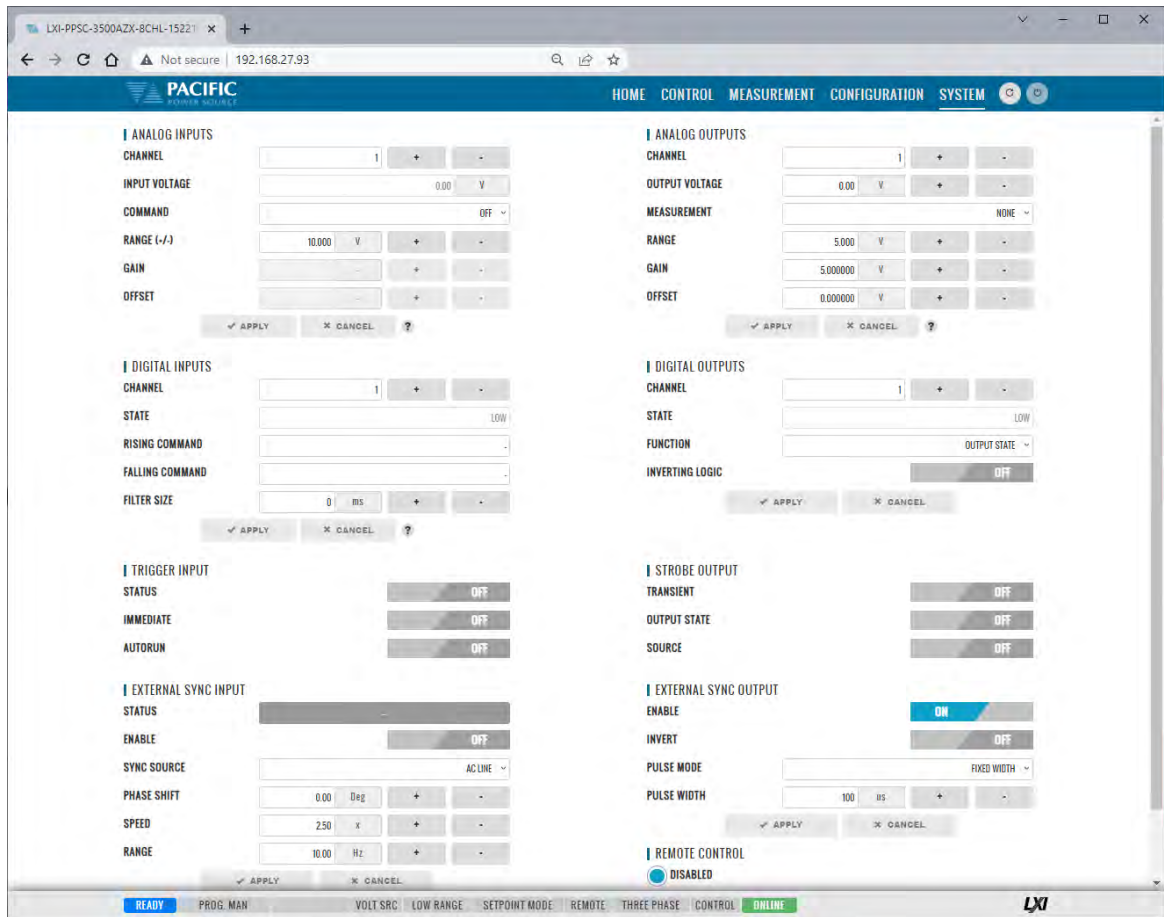



The Digital and Analog IO screen allows configuration of the available Auxiliary I/O functions. Note that this feature is not available on AZX-2L and AZX-4L models.



10.10.6.1 Function Groups

There are nine groups of functions that are available to be configured with the selectable settings listed in the table below.

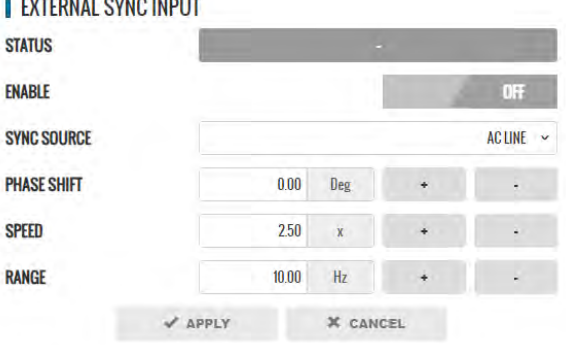
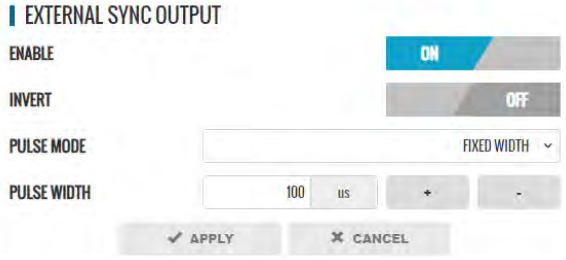
Grouping	Controls
<p>Analog Inputs:</p> <p>CHANNEL [1 2 3 4]</p> <p>INPUT VOLTAGE Displays read back voltage</p> <p>COMMAND Select command from dropdown list or OFF for none</p> <p>RANGE 0.0000 – 10.000 V</p> <p>GAIN Gain</p> <p>OFFSET Offset value</p>	
<p>Analog Outputs:</p> <p>CHANNEL [1 2 3 4]</p> <p>OUTPUT VOLTAGE Output setting</p> <p>MEASUREMENT Select measurement to be assigned to output</p> <p>RANGE 0.0000 – 5.000 V</p> <p>GAIN Gain 0.000 - 1000</p> <p>OFFSET Offset value – 1000 ~+1000</p>	
<p>Digital Inputs:</p> <p>CHANNEL [1 2 3]</p> <p>STATE Displays input state</p> <p>RISING CMD Set command string to execute on rising edge</p> <p>FALLING CMD Set command string to execute on falling edge</p> <p>FILTER SIZE 0 – 10,000,000 msec</p>	
<p>Digital Outputs:</p> <p>CHANNEL [1 2 3 4]</p> <p>STATE Displays current state</p> <p>FUNCTION Assigns state to selected channel. Available states are: FAULT FORM HIGH LOW OUTPUT STATE PROGRAM REMOTE TRANSIENT</p> <p>INV. LOGIC [ON OFF] Reverses polarity</p>	

Grouping	Controls
<p>Trigger Input:</p> <p>STATUS [ON OFF] Enabled or disabled</p> <p>IMMEDIATE [ON OFF] Ignore phase update setting if ON</p> <p>AUTORUN [ON OFF] No RUN command required if ON</p>	 <p>The screenshot shows the 'TRIGGER INPUT' control panel. It includes three toggle switches: 'STATUS' (OFF), 'IMMEDIATE' (ON), and 'AUTORUN' (OFF). At the bottom are 'APPLY' and 'CANCEL' buttons.</p>
<p>Strobe Output:</p> <p>TRANSIENT ON = Strobe output on transient start</p> <p>OUTPUT STATE ON = Strobe output on relay close</p> <p>SOURCE ON = Strobe output on any program parameter change</p>	 <p>The screenshot shows the 'STROBE OUTPUT' control panel. It includes three toggle switches: 'TRANSIENT' (OFF), 'OUTPUT STATE' (OFF), and 'SOURCE' (OFF). At the bottom are 'APPLY' and 'CANCEL' buttons.</p>
<p>External Sync Input:</p> <p>STATUS Display SYNC Status</p> <p>ENABLE [ON OFF]</p> <p>SYNC SOURCE Select Sync source</p> <p>Available sources are: - AC LINE (AC input to power source) - DIGITAL INPUT (TTL)</p> <p>PHASE SHIFT Offset Phase A angle</p> <p>SPEED 1.00 ~ 10.00 times</p> <p>RANGE 0.10 ~ 500 Hz</p>	 <p>The screenshot shows the 'EXTERNAL SYNC INPUT' control panel. It includes a 'STATUS' display showing '-', an 'ENABLE' toggle (OFF), a 'SYNC SOURCE' dropdown menu (AC LINE), and three numeric input fields with units and +/- buttons: 'PHASE SHIFT' (0.00 Deg), 'SPEED' (2.50 x), and 'RANGE' (10.00 Hz). At the bottom are 'APPLY' and 'CANCEL' buttons.</p>
<p>External Sync Output:</p> <p>ENABLE [ON OFF]</p> <p>INVERT [ON OFF]</p> <p>PULSE MODE [FIXED WIDTH DUTY CYCLE]</p> <p>PULSE WIDTH 3 ~ 1000000 µsec</p>	 <p>The screenshot shows the 'EXTERNAL SYNC OUTPUT' control panel. It includes three toggle switches: 'ENABLE' (ON), 'INVERT' (OFF), and 'PULSE MODE' (FIXED WIDTH). Below 'PULSE MODE' is a 'PULSE WIDTH' input field (100 µs) with +/- buttons. At the bottom are 'APPLY' and 'CANCEL' buttons.</p>
<p>Remote Controls:</p> <p>DISABLED No remote output control</p> <p>REMOTE INHIBIT Contact closure needed to close output relay</p> <p>REMOTE ENABLE Contact closure or front panel can control output relay</p>	 <p>The screenshot shows the 'REMOTE CONTROL' panel. It includes three radio buttons: 'DISABLED' (selected), 'REMOTE INHIBIT', and 'REMOTE ENABLE'.</p>

10.10.6.2 On-line Analog and Digital I/O help screens.

To aid in configuring and using the many I/O capabilities of the power source, a series of on-line help screens containing formulas and graphs for digital and analog I/Os settings are provided.

Some screens are shown below for reference.

ANALOG OUTPUTS

The output voltage will be automatically set with a VALUE given by this formula:

$$VALUE = \frac{MEASUREMENT - OFFSET + CO * GAIN}{GAIN * CG} * RANGE$$

- CG is the calibration gain. By default, it is 1 and it can be set with SYSTEM:AIO-Output#-CALibration-GAIN
- CO is the calibration offset. By default, it is 0 and it can be set with SYSTEM:AIO-Output#-CALibration-OFFset

The GAIN and OFFSET change when the measurement is changed while the CO and CG do not change.

With CO equal to 0 and CG equal to 1, the formula is:

$$VALUE = \frac{MEASUREMENT - OFFSET}{GAIN} * RANGE$$

ANALOG INPUTS

The selected COMMAND will be automatically set with a VALUE given by this formula:

$$VALUE = \left(\frac{INPUT VOLTAGE}{RANGE} * CG - CO \right) * GAIN + OFFSET$$

- CG is the calibration gain. By default, it is 1 and it can be set with SYSTEM:AIO-Input#-CALibration-GAIN
- CO is the calibration offset. By default, it is 0 and it can be set with SYSTEM:AIO-Input#-CALibration-OFFset

The GAIN and OFFSET change when the COMMAND is changed while the CO and CG do not change.

With CO equal to 0 and CG equal to 1, the formula is:

$$VALUE = \left(\frac{INPUT VOLTAGE}{RANGE} \right) * GAIN + OFFSET$$

10.10.7 Remote Interface (Virtual Front Panel)



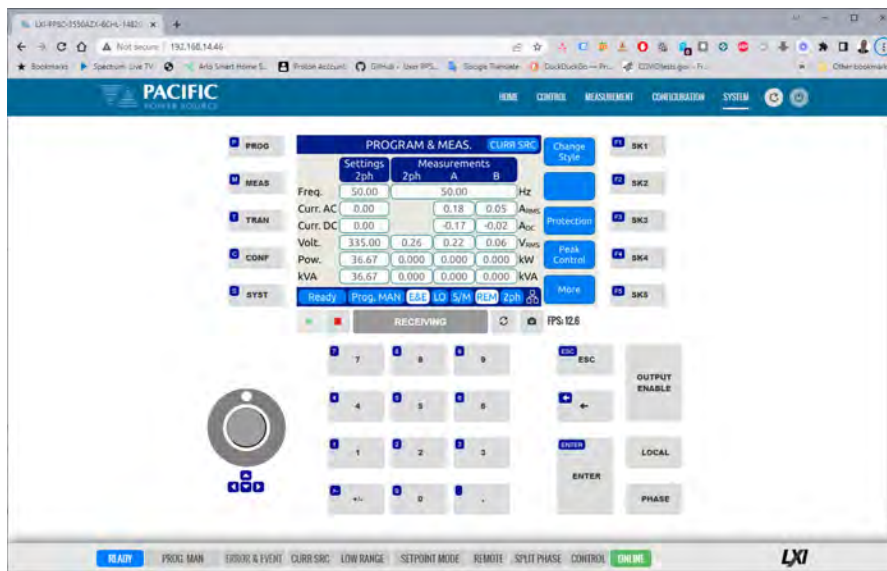

The Remote Interface browser screen provides a virtual front panel that allows controlling the power source from a remote location using a PC, tablet or smart phone. The screen layout is a function of the web hosting device screen width. If wide enough, the layout will match that of the actual front panel of the power source. If too narrow for a landscape view, the front panel will be divided between the LCD screen, function and soft keys on top and the know plug decimal keypad and other control beneath it. Both layouts are shown below.



The operation of this Virtual Front panel is identical of that of the physical front panel so refer to Section 6, “Front Panel Operation” on page 103 for user information. The controls located directly below the virtual LCD screen may be used when the internet connection used is slow or there is too much latency.



Available controls are:

-  Enable continuous update mode. In this mode, the status bar will show .
-  Stop continuous updated mode. The connection status will show .

RECEIVING Status Bar shows state of connection to the power source. Clicking on it will toggle connections status between **DISCONNECTED** and **CONNECTED**.

 Refresh button may be used when continuous updates are off to refresh the display.

 Click to download a .png image of the virtual LCD display.

The status field to the right of the control buttons displays the measurement frame update rate. In the example shown here the frame rate is 14.6 frames per second.

10.10.8 Unit Information

The Unit Information screen contains some of the same information as is found on the HOME screen but it can be used to query this information from one or more auxiliary unit as well in a parallel system. The HOME screen will only display information for the Master unit of a parallel configured system. Use the SELECTED UNIT control to select units downstream from the master (1).

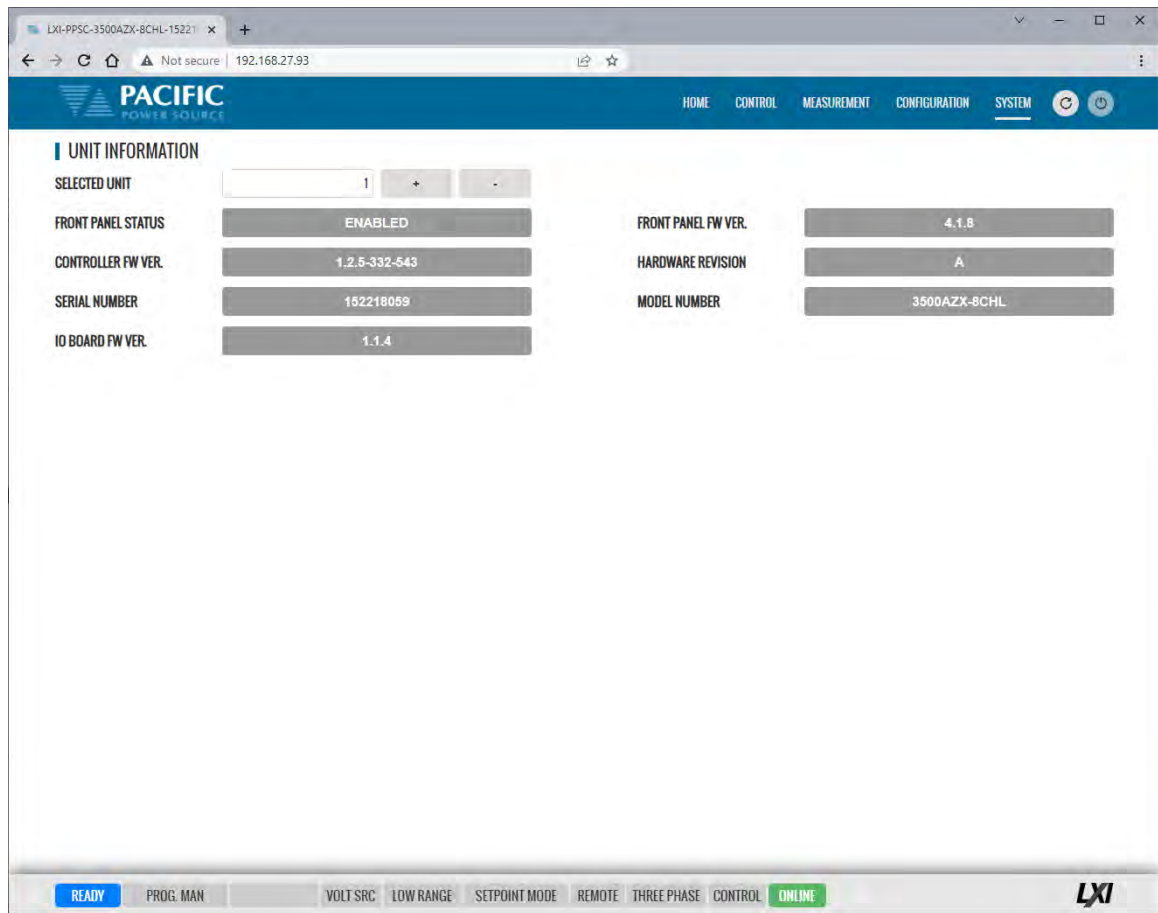

10.10.9 Connected Units

The Connected Units screen displays the number of powered on units connected in either a Parallel or Series system. It also allows the expected number of units to be set so the master can determine if all connected units are indeed turned on before starting operation.

The MANUAL DISCOVERY can be run to refresh the system configuration if a unit has been turned on or off without power cycling the master.

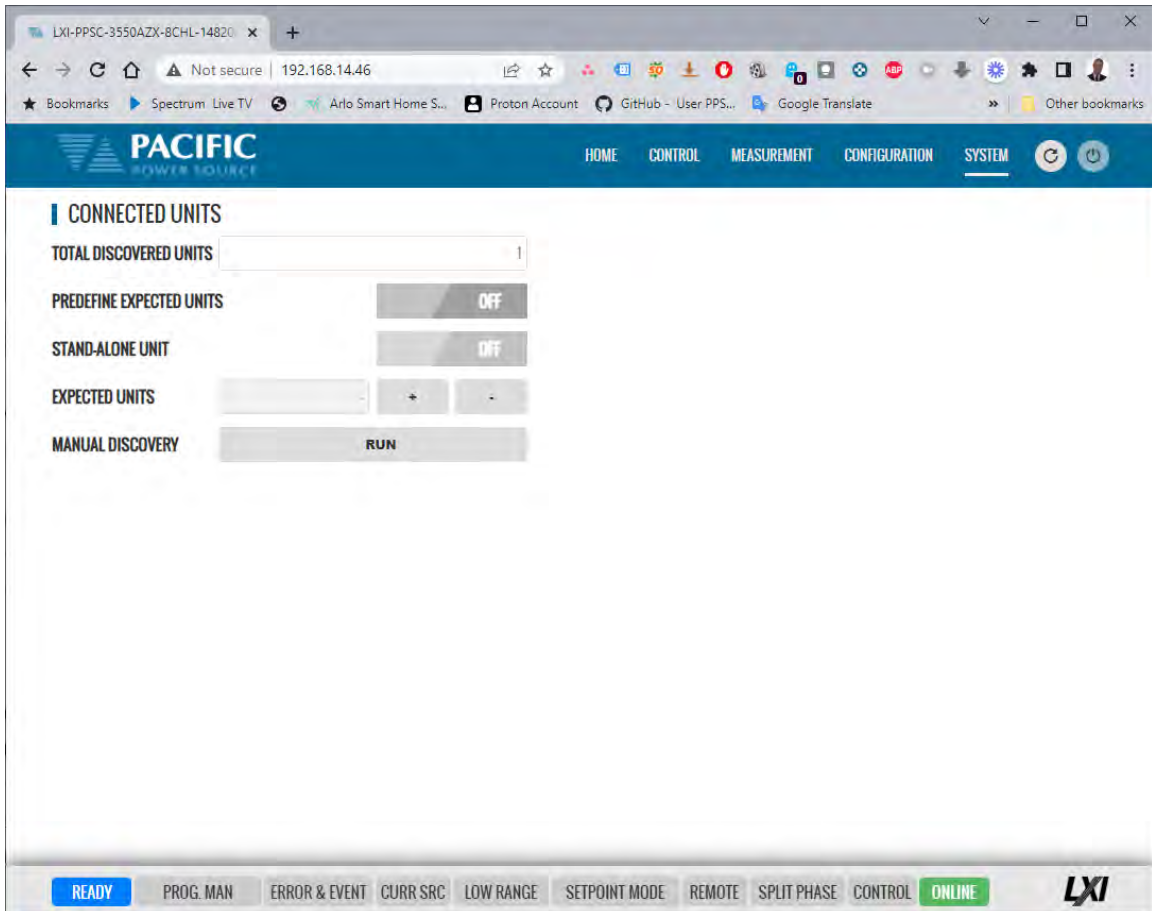

10.10.10 Memory Browser

The Memory Browser screen shows available memory devices connected to the instrument including internal memory and available directories and files. All data and setup files are in XML format. Waveform files are stored in CSV format. Screen captures are stored in PNG image format.

Available MEMORY DRIVES are INTERNAL, RAM and any USB or SD-Card memory devices that are mounted. Files can be copied or moved from other drives by using drag & drop or by selecting them. Files can also be uploaded using a file selection window dialog.

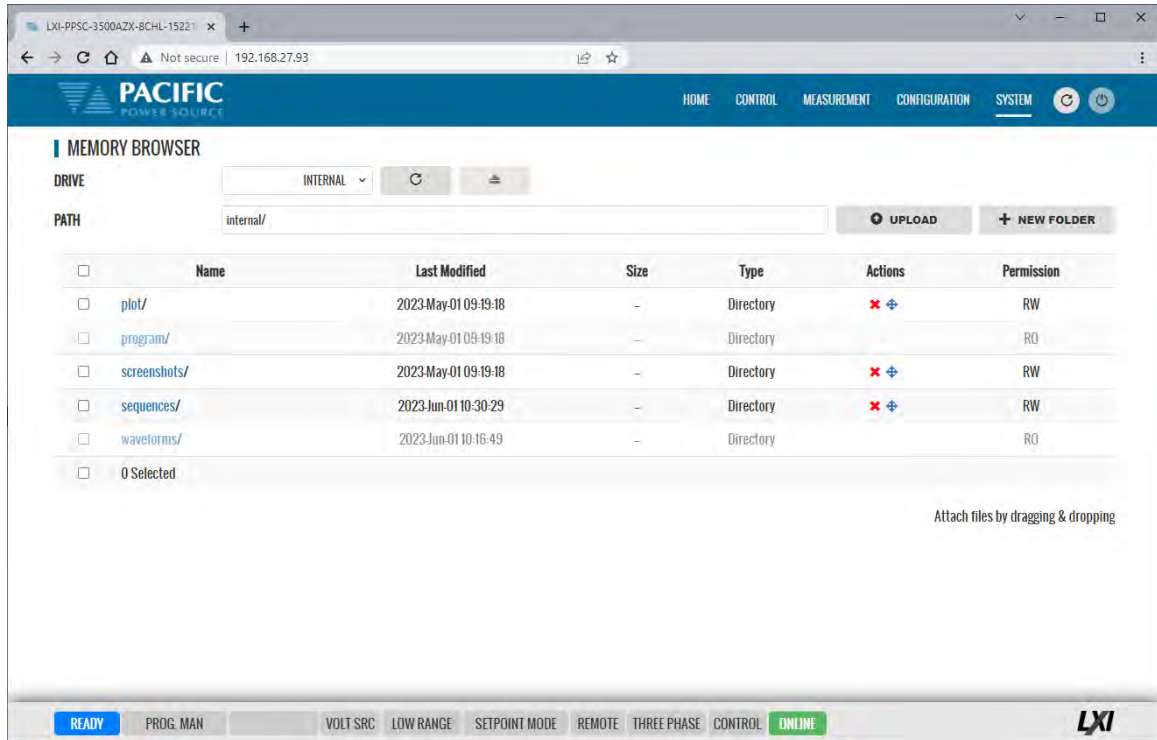

Useful directories for the user are:

DIRECTOR	FILES IN THIS DIRECTORY
plot/	Data logger plots in csv file format with date and time stamp
program/	Power source program settings
sequences/	Test sequences stored in internal memory
screenshots/	Screen capture image files in .png format with date and time stamp. To capture any LCD display, press the LOCAL key and the number 1 key on the decimal keypad at the same time.
waveforms/	User waveform data points in csv file format.

10.10.11 Calibration

The Calibration screen shows all user accessible calibration coefficients. It also allows for user calibration of voltage and current to be performed. The Web Browser user interface is specific but the procedures and equipment are the same as calibration from the front panel. Refer to Section 11.4, “Calibration Procedures” for details.

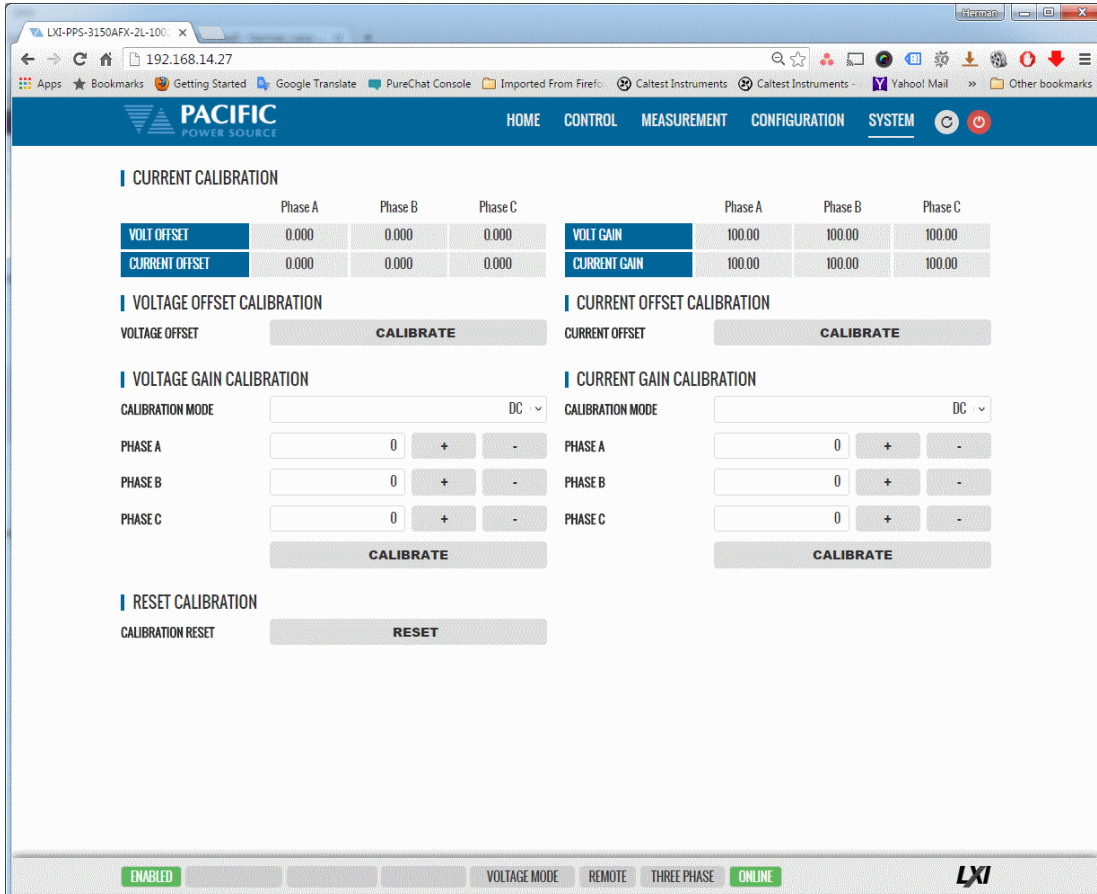

10.10.12 Remote Support

The Remote Control screen allows Pacific Power’s technical support staff to access the unit remotely if granted permission. Internet access is required for this feature.

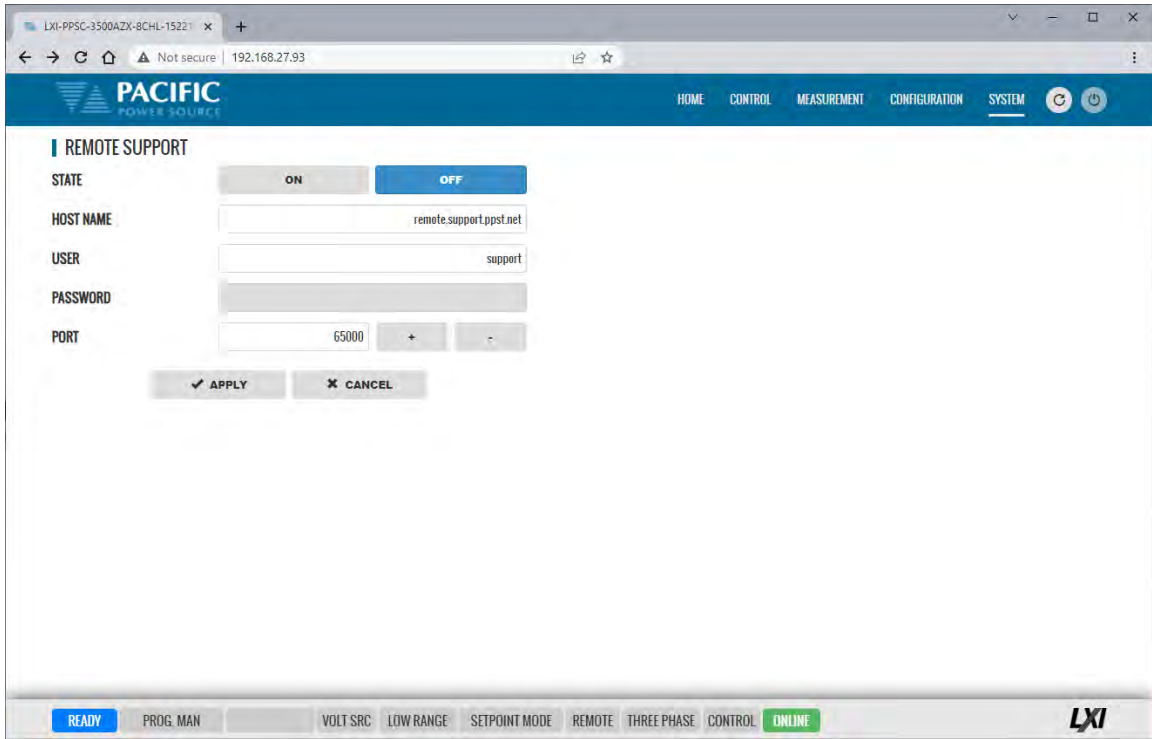

10.10.13 Import / Export



A compressed file containing complete system configuration data for the power source can be exported to a file and imported back into the unit as needed. Files are .7z compressed to maximize storage space. Use the Export button on the right to export (save) current configuration data. Use the Browse button to select and import (load) a previously saved configuration file.



10.10.14 Firmware Update

The Firmware update screen can be used to install new firmware from a file. New firmware may be distributed by email or from Pacific’s FTP site. Note that the OUTPUT of the unit must be OFF to perform a firmware update.

If you received a firmware image file (.img extension):

- Use the  button to select it from the drive location you saved it to.
- Then use the  button to upload new firmware to the power source.

To install new firmware from the Pacific Power FTP server:

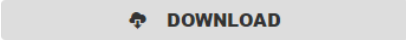
- Click the  button.

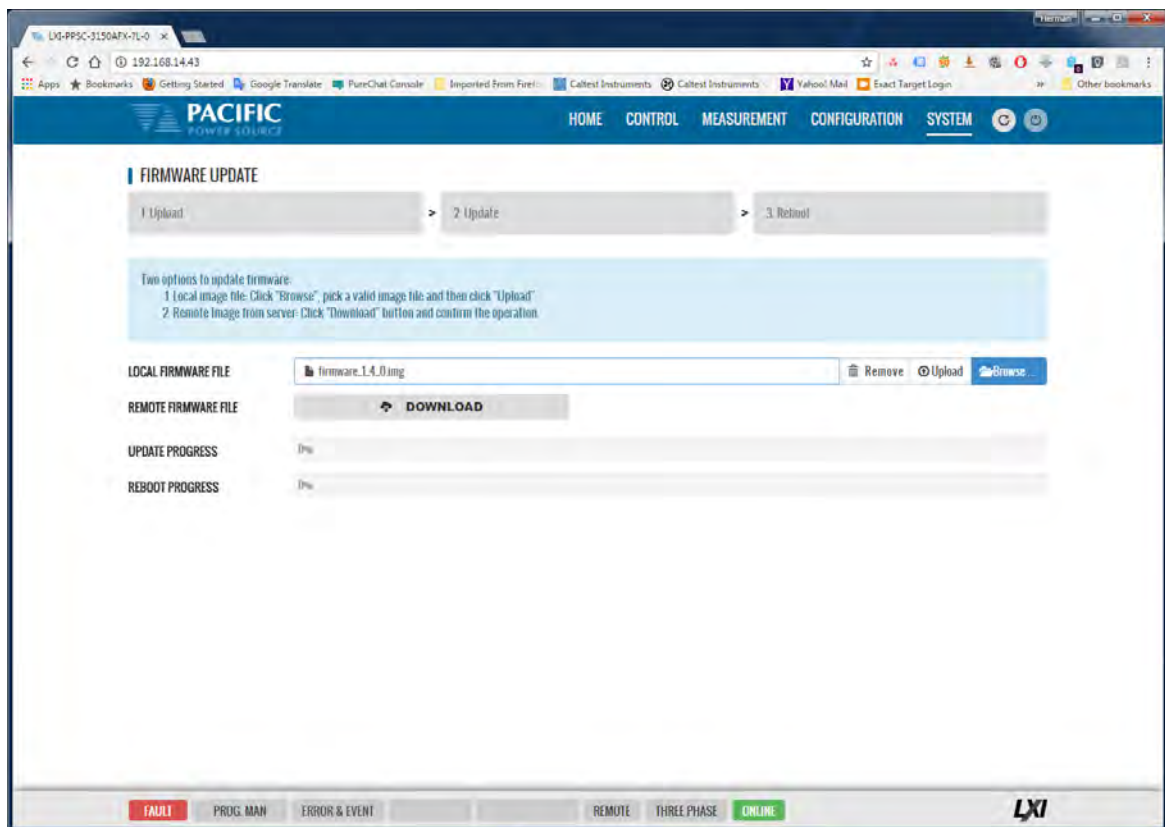

10.10.15 Sanitize and Reboot

This screen allows the unit to be cleared of all user settings. This applies to waveforms, settings, transients etc. The unit will be reset to factory default conditions.

The Reboot allows the power source to be rebooted (reset) without cycling AC input power.

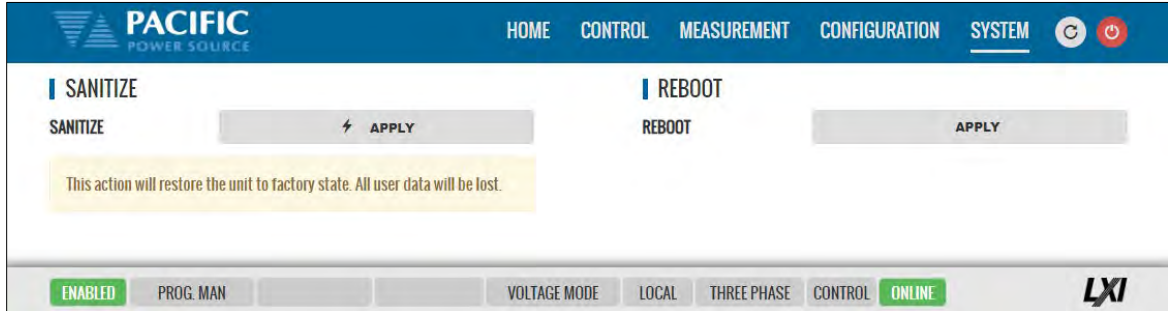

10.11 Additional Functions

Additional functions may be added over time through firmware updates that may not be covered by this user manual revision. If so, check the Pacific Power website for updated manual versions. (www.pacificpower.com).

10.11.1 Sharing Options – FTP & SAMBA

The power source supports a network based sharing feature. Two protocols. These can be enabled from the Sharing Options screen. For more details, refer to Section 6.8.5.9, “REMOTE SHARING” on page 203.



11 Calibration

11.1 Calibration Interval

All units are shipped new from the factory with NIST traceable calibration. It is recommended to perform an annual calibration check to ensure performance to specifications. Under normal circumstances, no adjustment will be needed but can be made as part of the user calibration coefficients.

11.2 Closed Case User Calibration

This section covers routine calibration that can be performed by the user. User calibration does not affect the factory set calibration coefficients that were determined and set at the time of shipment to ensure compliance with published specifications. Rather, user calibration can be used to obtain enhanced performance at typical operating conditions by adjusting these user coefficients at these conditions. For example, if the unit is used primary for testing 400Hz, three phase 115V L-N three phase operation, calibrating the user coefficients to these operating conditions against an external precision reference can provide enhanced performance versus published specifications (See Section 4, “Technical Specifications”).

Since user calibration does not affect factory calibration settings, resetting all user calibration coefficients does not invalidate the unit’s specified performance and it can be used with all user coefficients reset as needed.

Note: There are no analog adjustment pots in this instrument and all calibration can be performed from the front panel or over one of the digital control interfaces.

11.3 Equipment Required

The following list of equipment or equivalent is required to perform routine annual calibration of the instrument. Current sensor options are determined by need for AC, DC or both.

Item	Make	Model	Notes
1	Keysight	34465A	6 ½ Digit DMM or equivalent
2	Current Transformer (AC Only)	Pearson	Model 110, 65 Arms Max. 5000Apk Max. 0.1V/A +1/-0%, Rout = 50 Ohms http://www.pearsonelectronics.com/products/current-monitors
3	Current Sensor (AC and DC)	LEM	IT 200-S ULTRASTAB, 200 A, ± 0.0086% Accuracy, 50 kHz BW or equivalent. https://www.lem.com/en/product-list/it-200s-ultrastab Requires precision burden resistor for direct DMM measurements, i.e. Reidon, P/N SM10-100RX, 0.01% 100 Ohm, 0.3W, qty 2 or 3 in parallel for 50 Ohm or 33.3 Ohm burden https://www.digikey.com/product-detail/en/riedon/SM10-100RX/696-1568-ND/4832952
4	Current Shunt (DC)	Ohm-Labs	CS-200, Shunt, 1 mOhm, 0.02% Accuracy @ DC to 50/60 Hz or equivalent http://www.ohm-labs.com

Table 11-1: Required Calibration Equipment

11.4 Calibration Procedures

Calibration of output and measurements is performed by a single procedure so there is no need to calibrate each separately. Calibration involves voltage and current full scale and offset on each phase. For three-phase mode, this means there are twelve calibration points, for single-phase mode, there are four.

The calibration can be performed manually using the Calibration menu (refer to Section 6.8.9 for the location of the Calibration menu) or through the build-in web server using the web browser interface. Refer to Section 10.10.10, "Calibration" for access to the Web based calibration screens.

11.4.1 Voltage Calibration – Offset

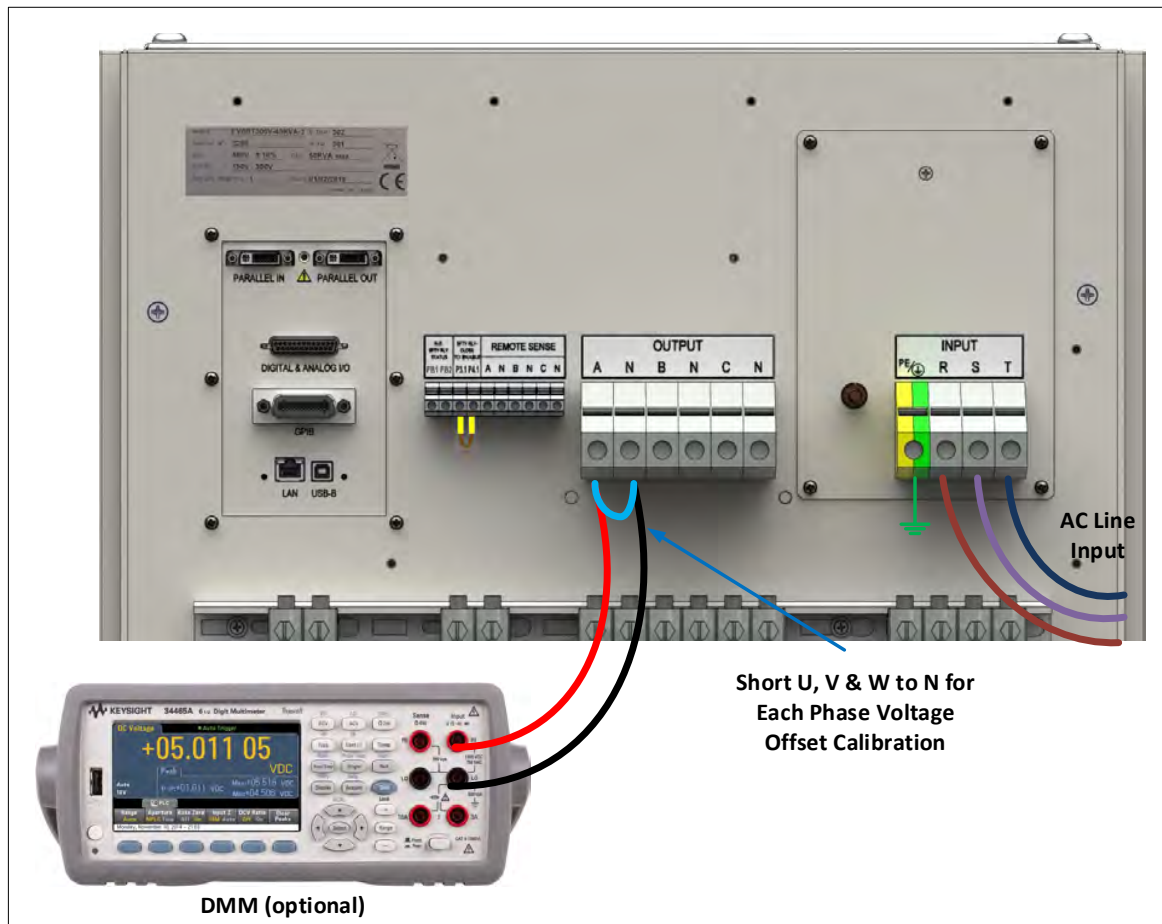
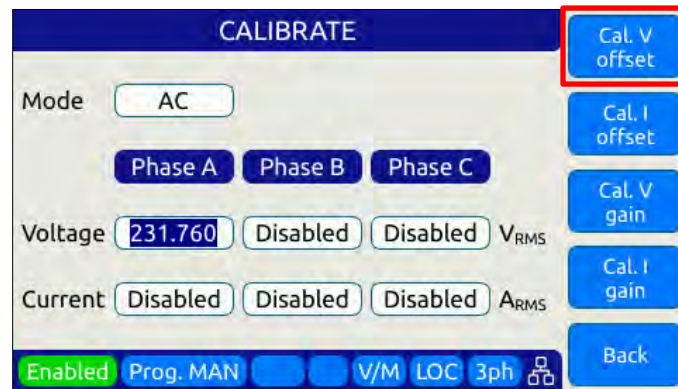

Table 11-2: Setup for Voltage Offset Calibration

The procedure to calibrate voltage offset is:



1. Select the Calibration entry from the “**System**” menu
2. Press the “Calibrate” soft key to enter calibration mode
3. Short all phases to neutral using a shorting jumper
4. You can connect the DMM to the output of phase A as shown in the figure above but it is not required for this calibration step.
5. **IMPORTANT:** Program both AC and DC voltage (depending on voltage mode) to all **zero volts** to avoid any current from flowing into the shorted outputs. Use PROGRAM screen to make sure both AC and DC settings are zero.
6. Enable the Output with the output shored.
7. Press "Cal V. offset" soft key
8. Wait for the V offset coefficients for all phases to be calculated and displayed
9. Remove the shorting jumper when done

Note: The Mode, Voltage and Current edit boxes do not affect this function.

11.4.2 Current Calibration - Offset

The procedure to calibrate current offset is:

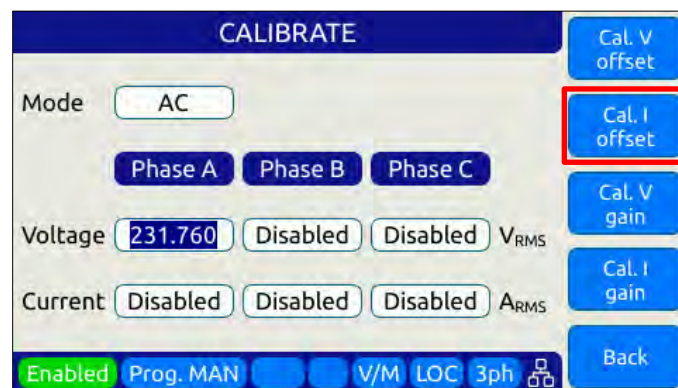

1. Select the Calibration entry from the “**System**” menu
2. Press the “Calibrate” soft key to enter calibration mode

3. Do not connect any load to the output
4. Enable the Output with no load connected
5. Press "Cal I. offset" soft key
6. Wait for the I offset coefficients for all phases to be calculated and displayed

Note: The Mode, Voltage and Current edit boxes do not affect this function.

11.4.3 Voltage Calibration - Gain

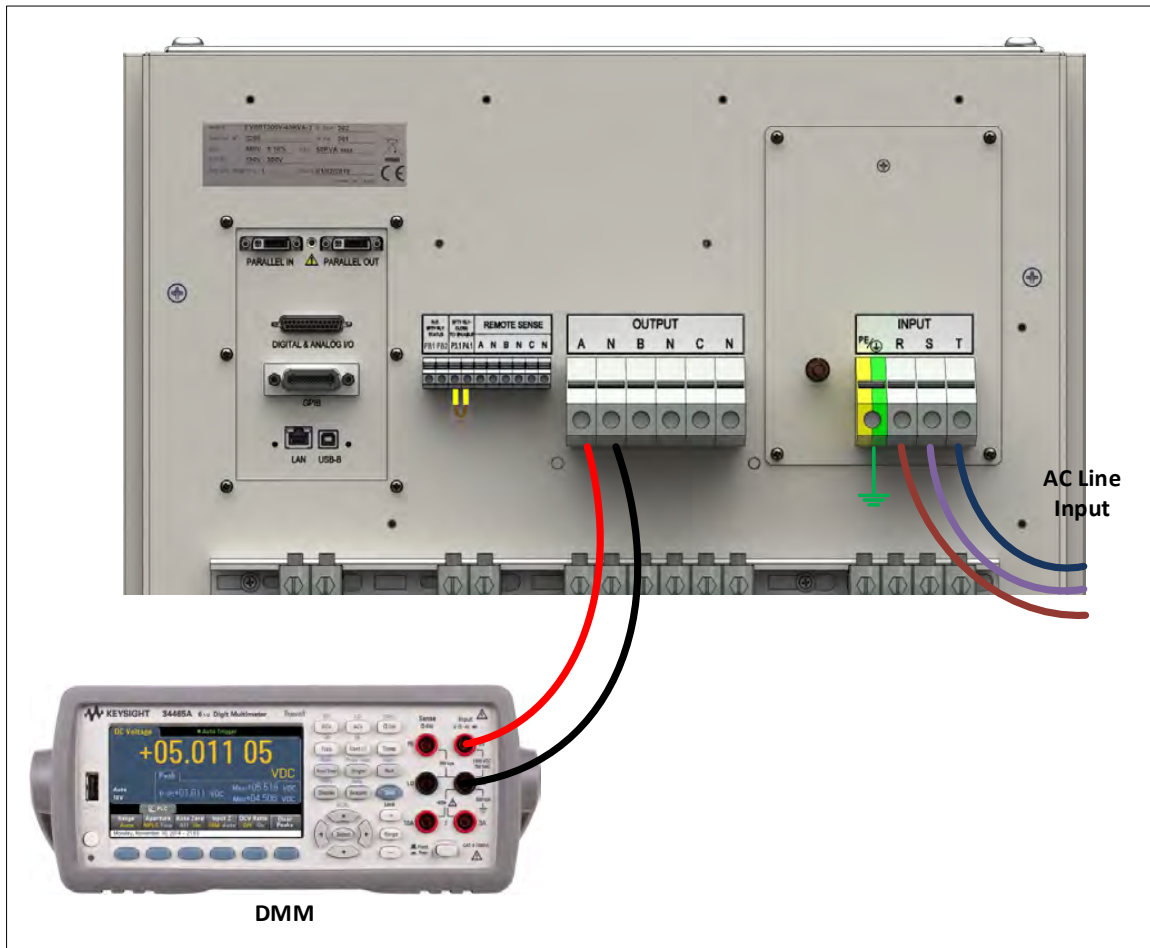
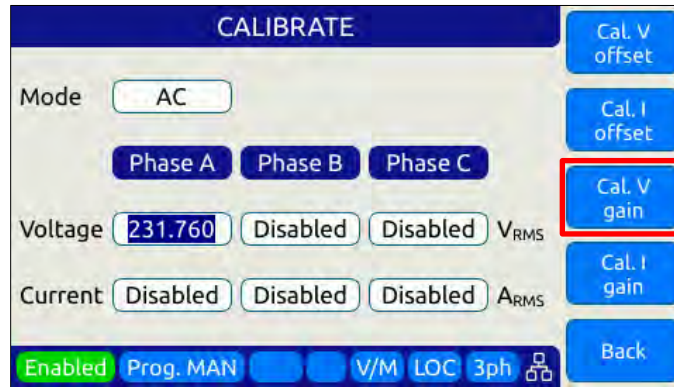

Figure 11-1: Voltage Calibration Equipment Setup – 1 or 3 Phase Mode – Phase A

The procedure to calibrate voltage gain is:



1. Select the Calibration entry from the “**System**” menu
2. Press the “Calibrate” soft key to enter calibration mode
3. Do not connect any load to the output
4. Program AC voltage to full scale 360.0 V_{rms} L-N for AC mode calibration or 510Vdc for DC mode calibration on all phases. Use the PROGRAM screen for this.
5. For AC mode calibration, set the Frequency to the most commonly used value depending on typical applications
6. NOTE: If the user calibration is targeted for specific operating conditions, for example Vac = 115V L-N and Freq = 400 Hz, use these settings instead of those suggested in steps 4 and 5
7. Enable the Output with no load connected
8. Enter the DMM VAC readings for all three phase in the respective Voltage data entry text boxes in the Calibration screen. Move the DMM probe from phase A, to B to C respectively to obtain each phase reading.
9. Press "Cal V. gain" soft key
10. Wait for the V gain coefficients for all phases to be calculated and displayed

Note: Voltage gain can be calibrated in DC mode as well if this is the predominant mode of use. Use the MODE fields at the top to select the desired mode.

11.4.4 Current Gain Calibration Setup Diagrams

For current calibration, a resistive load equivalent to 90% of maximum available RMS phase current for the phase mode selected is recommended. It is permissible to use only one load and move it between phases for three-phase mode calibration. For single-phase mode current calibration, a load capable of supporting 90% of maximum available single-phase current is recommended. The A, B and C phase outputs must be shorted together for single-phase mode operation.

Note: To guarantee that the current doesn't change during the calibration process, it is recommended that the unit is operated at current limit, but reducing its set point to the desired value. It is also recommended to use a stable load that provides a constant linear impedance to the unit.

A suitable current shunt must be connected in series with the load as shown below for three-phase mode. The sense terminals of the current shunt must be connected to the DMM Voltage input.

Three Phase Mode Setup

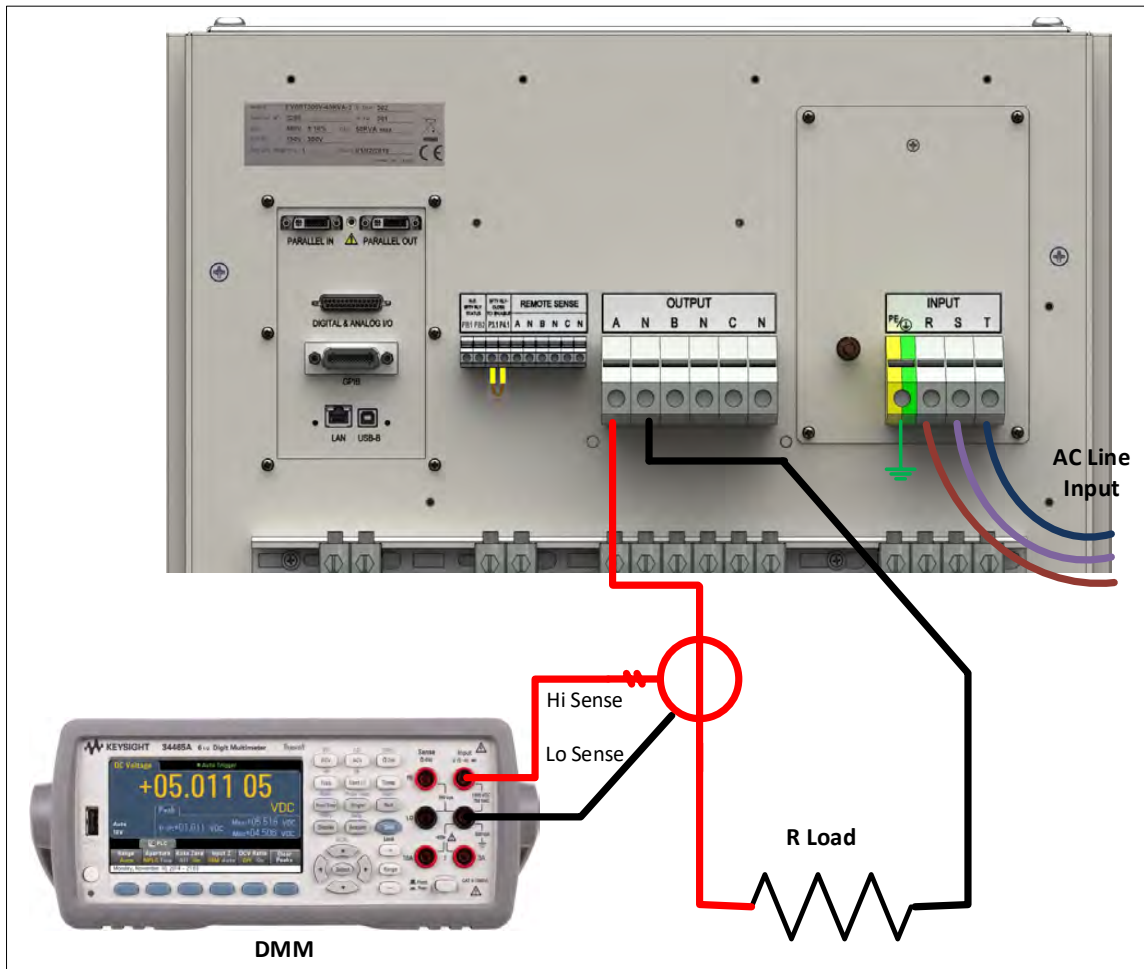

Figure 11-2: Current Calibration Equipment Setup – 3 Phase Mode – Phase A

Single Phase Mode Setup

For Single-phase mode current Calibration, the load must have the appropriate size. See next section for recommended load value by model and phase mode.

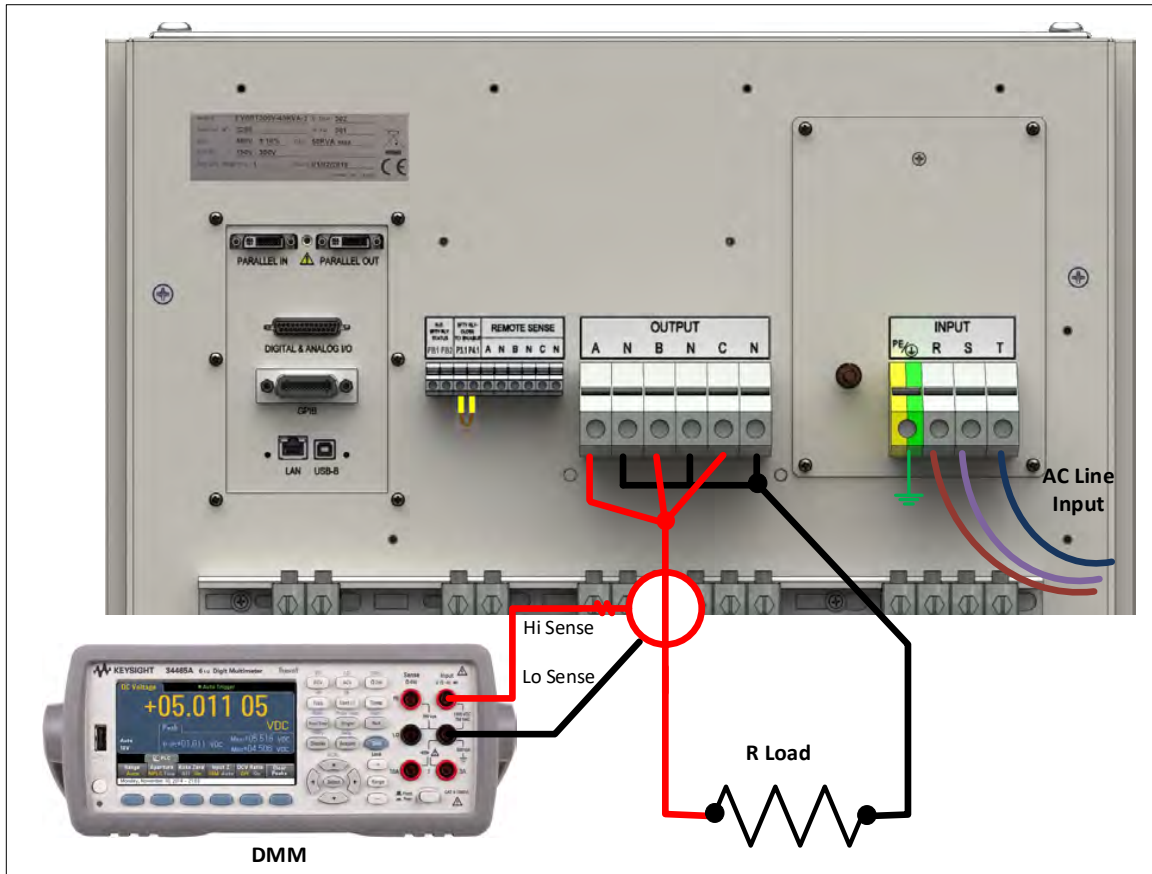

Figure 11-3: Current Calibration Equipment Setup – 1 Phase Mode

11.4.1 Current Calibration Load Values

Full-scale current gain calibration is best performed at current levels that are around 90% of full scale current. Since the AZX Series® has dual voltage ranges, maximum RMS current is available at 110Vrms for 3300AZX and 128Vrms L-N for 3550AZX & 3550AZX on each phase in the low voltage range. For single-phase mode, the current is three times higher. Thus, to obtain 90% of load current, the load resistor used must be sized to draw this current level at around 110Vrms or 128Vrms. The table below shows the recommended resistor values or resistive load bank settings.

Model	Rating/phs VA/W	Three & Two Phase Mode Calibration			Single Phase Mode Calibration		
		Max. I _{rms} /phs	Current (90%)	Recommended R Load (Ohm)	Max/ I _{rms}	Current (90%)	Recommended R Load (Ohm)
3300AZX	10000	90.0	81	1.3	270	243	0.46
3550AZX	16667	130.0	117	1.1	390	338	0.38

Table 11-3: Calibration Load Values Phase Mode

11.4.2 Current Calibration - Gain

The procedure to calibrate current gain is:

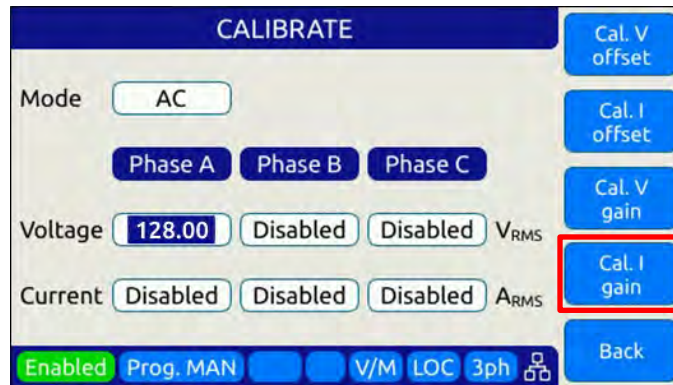

1. Select the Calibration entry from the “**System**” menu
2. Press the “Calibrate” soft key to enter calibration mode
3. Connect the required resistive load value to the output of phase A or all three outputs if three loads are available.
4. Select the Low Voltage Range and program AC voltage to 128.0 Vrms L-N on all phases
5. Set the Frequency to the most commonly used value depending on typical applications
6. Enable the Output
7. Allow the load current to stabilize by monitoring the DMM current reading for each phase.
8. Enter the DMM VAC readings for all three phase in the respective Current data entry text boxes in the Calibration screen. If only one shunt and load is available, repeat the above steps for phase B and C making sure to turn OFF the output before moving the load and shunt to the next phase.
9. Press "Cal I. gain" soft key
10. Wait for the I gain coefficients for all phases to be calculated and displayed

Note: Current gain can be calibrated in DC mode as well if this is the predominant mode of use. Use the MODE fields at the top to select the desired mode.

11.4.3 Exit Calibration Mode

To exit the calibration mode once done, press the “**Back**” software.

12 Warnings & Error Messages

12.1 Preface

During normal operation, a series of error and/ or warning messages may be displayed on the front panel LCD display or reported by the error queue over one of the remote control interfaces. This section of the manual lists available warning and error messages in numerical order and provided some additional information on their meaning and possible causes. Where relevant, suggested remedies to resolve any conditions are included as well.

Note: There are some Error and Warning messages that may appear in the Errors & Events that are **NOT** listed in the next section. In case you encounter an unlisted error or warning message and code, contact Pacific Power customer service (support@pacificpower.com) and describe the number and description to obtain further information.

After reporting such an event, try rebooting the power sources by cycling power as most of these conditions will clear up with a reboot.

12.2 Errors & Warnings Messages in Numeric Order

Source	Code	Type	Description	Possible cause
Frontpanel	-500	"SCPI standard event"	"Event: Power ON."	Power on event detected. Normal after power on
Frontpanel	-350	"SCPI standard event"	"E&E queue overflow."	
Frontpanel	-360	"SCPI standard error"	"Communication error with an interface."	
Frontpanel	-320	"SCPI standard error"	"Storage fault."	
Frontpanel	-310	"SCPI standard error"	"System error"	
Frontpanel	-290	"SCPI standard error"	"Execution error: Memory use error."	
Frontpanel	-286	"SCPI standard error"	"Execution error: Not allowed command with the current configuration."	
Frontpanel	-285	"SCPI standard error"	"Execution error: Program syntax error."	
Frontpanel	-284	"SCPI standard error"	"Execution error: Program is currently running."	
Frontpanel	-282	"SCPI standard error"	"Execution error: Invalid program name."	
Frontpanel	-281	"SCPI standard error"	"Execution error: Cannot create program."	
Frontpanel	-256	"SCPI standard error"	"Execution error: File not found."	
Frontpanel	-253	"SCPI standard error"	"Execution error: Media is corrupted."	
Frontpanel	-240	"SCPI standard error"	"Execution error: Hardware error."	
Frontpanel	-224	"SCPI standard error"	"Execution error: Illegal parameter value."	
Frontpanel	-222	"SCPI standard error"	"Execution error: Argument out of range."	
Frontpanel	-221	"SCPI standard error"	"Execution error: Conflict in configuration setting."	
Frontpanel	-203	"SCPI standard error"	"Execution error: Permission denied."	
Frontpanel	-158	"SCPI standard error"	"Command error: String data is not allowed."	
Frontpanel	-138	"SCPI standard error"	"Command error: Numeric suffix is invalid."	

Source	Code	Type	Description	Possible cause
Frontpanel	-131	"SCPI standard error"	"Command error: Numeric suffix is out of range."	
Frontpanel	-113	"SCPI standard error"	"Command error: Undefined header."	
Frontpanel	-109	"SCPI standard error"	"Command error: Invalid number of parameters."	
Frontpanel	-108	"SCPI standard error"	"Command error: Parameters error."	
Frontpanel	-103	"SCPI standard error"	"Command error: Invalid separator."	
Frontpanel	-102	"SCPI standard error"	"Command error: Syntax error."	
Frontpanel	18	"Error"	"Unavailable transient element."	
Frontpanel	19	"Error"	"Maximum number of transient elements."	
Frontpanel	21	"Error"	"Calibration factor value too high"	Out of range. Values differ more than 5 %
Frontpanel	22	"Error"	"Calibration factor value too low"	
Frontpanel	29	"Error"	"USB interface unknown state."	
Frontpanel	31	"Error"	"Interface request packet"	Not empty
Frontpanel	32	"Error"	"Interface request packet"	Unknown type
Frontpanel	33	"Error"	"Interface request packet"	Incompatible type
Frontpanel	34	"Error"	"Interface request packet out of space."	
Frontpanel	35	"Error"	"Interface request packet"	Unavailable command request
Frontpanel	36	"Error"	"Interface request packet has invalid arguments."	
Frontpanel	37	"Error"	"Interface response packet out of space."	
Frontpanel	42	"Error"	"Memory in use was removed."	
Frontpanel	47	"Error"	"Front panel is shutting down."	
Frontpanel	48	"Error"	"Fault state cannot be automatically reset."	
Frontpanel	51	"Error"	"The command cannot be executed in auxiliary unit."	
Frontpanel	53	"Error"	"Error during firmware update."	
Frontpanel	54	"Error"	"Calibration coefficient cannot be negative."	
Frontpanel	57	"Error"	"Waveform is not available."	
Frontpanel	58	"Error"	"Waveforms lengths are different between controllers."	
Frontpanel	59	"Error"	"Unit does not exist."	
Frontpanel	60	"Error"	"Cannot read ambient temperature."	
Frontpanel	64	"Error"	"Unexpected reset."	
Frontpanel	65	"Error"	"Front panel is in passive mode."	
Frontpanel	66	"Error"	"Invalid host name."	
Frontpanel	67	"Error"	"DC voltage setpoint cannot change due to waveform saturation."	
Frontpanel	68	"Error"	"AC voltage setpoint cannot change due to waveform saturation."	
Frontpanel	69	"Error"	"Maximum user limit is lower than setpoint."	
Frontpanel	70	"Error"	"Minimum user limit is higher than setpoint."	
Frontpanel	72	"Error"	"Minimum limit is higher than maximum."	

Source	Code	Type	Description	Possible cause
Frontpanel	73	"Error"	"Maximum limit is lower than minimum."	
Frontpanel	75	"Error"	"IP address conflict. May be duplicated."	
Frontpanel	76	"Error"	"Invalid filename."	
Frontpanel	77	"Error"	"External memory storage is not available."	
Frontpanel	78	"Error"	"Datalogger rate not allowed."	
Frontpanel	79	"Error"	"Datalogger is running"	You must stop it to change the configuration
Frontpanel	80	"Error"	"Datalogger execution error."	
Frontpanel	83	"Error"	"Internal error: File system partition blocked."	
Frontpanel	84	"Error"	"Unable to change form while output is enabled."	
Frontpanel	85	"Error"	"Unable to clear one or more fault."	
Frontpanel	86	"Error"	"Unable to enable output. One or more primary stages failed to enable."	
Frontpanel	89	"Error"	"Digital I/Os interface conflict: Remote inhibit is active."	
Frontpanel	90	"Error"	"Digital I/Os interface conflict: Remote enable is active."	
Frontpanel	91	"Error"	"Internal error: Unknown phase mode."	
Frontpanel	92	"Error"	"Unable to disable output. One or more primary stages failed to disable."	
Frontpanel	95	"Error"	"Digital I/Os interface conflict: Serial interface flow control is active."	
Frontpanel	96	"Error"	"Datalogger storage error."	
Frontpanel	97	"Error"	"Output enable in progress."	
Frontpanel	98	"Error"	"DC Voltage not allowed in "AC mode"."	
Frontpanel	99	"Error"	"AC Voltage not allowed in "DC mode"."	
Frontpanel	100	"Error"	"DC voltage setpoint cannot change due to user limit."	
Frontpanel	101	"Error"	"AC voltage setpoint cannot change due to user limit."	
Frontpanel	102	"Error"	"DC voltage setpoint cannot change due to low range."	
Frontpanel	103	"Error"	"AC voltage setpoint cannot change due to low range."	
Frontpanel	104	"Error"	"Waveform change in progress."	
Frontpanel	105	"Error"	"Error changing service name"	
Frontpanel	106	"Error"	"Error getting service name"	
Frontpanel	109	"Error"	"Transient step mode not available on UPC compatible mode."	
Frontpanel	110	"Error"	"System is about to reboot."	
Frontpanel	111	"Error"	"Cannot reboot system."	
Frontpanel	115	"Error"	"Unable to renew the DHCP lease. Changing to Auto-IP mode."	
Frontpanel	116	"Error"	"Failed starting firmware update."	
Frontpanel	117	"Error"	"Unable to execute this action with output enabled."	

Source	Code	Type	Description	Possible cause
Frontpanel	118	"Error"	"Frequency setpoint cannot change due to waveform saturation."	
Frontpanel	119	"Error"	"Frequency setpoint cannot change due to user limit."	
Frontpanel	120	"Error"	"Frequency not allowed in "DC mode"."	
Frontpanel	121	"Error"	"Waveform setpoint cannot change due to waveform saturation."	
Frontpanel	122	"Error"	"Cannot load program. Run PROG:CHECK? for more information."	
Frontpanel	125	"Error"	"Remote inhibit cannot be disabled in this model."	
Frontpanel	126	"Error"	"Line to line measurements only available with sinewaves."	
Frontpanel	127	"Error"	"Digital I/Os interface conflict: Single-Phase relay control is active."	
Frontpanel	128	"Error"	"Digital I/Os interface conflict: Single-Phase relay cannot change with output enabled."	
Frontpanel	129	"Error"	"Digital I/Os interface conflict: Single-Phase relay cannot change due relay closed."	
Frontpanel	130	"Error"	"Unable to disable output. One or more inverter stages failed to disable."	
Frontpanel	131	"Error"	"Cannot set EEPROM field"	
Frontpanel	132	"Error"	"EEPROM field already set"	
Frontpanel	133	"Error"	"Cannot read EEPROM field"	
Frontpanel	148	"Error"	"Serial number mismatch: Front panel does not match power stages."	
Frontpanel	150	"Error"	"Suffix not allowed in single form."	
Frontpanel	151	"Error"	"Suffix not allowed in split form."	
Frontpanel	152	"Error"	"Peak current limit setting is too low for the desired voltage and frequency."	
Frontpanel	153	"Error"	"Program transient trigger input is disabled."	
Frontpanel	154	"Error"	"Steady state not yet stabilized."	
Frontpanel	155	"Error"	"Trigger output not available in this model."	
Frontpanel	156	"Error"	"Trigger input not available in this model."	
Frontpanel	157	"Error"	"Filter size must be an odd number."	
Frontpanel	158	"Error"	"Voltage mode not available in UPC compatible mode."	
Frontpanel	159	"Error"	"Waveform is unique in UPC compatible mode."	
Frontpanel	160	"Error"	"Phase is 180 for split in UPC compatible mode."	
Frontpanel	161	"Error"	"Voltage AC is unique in UPC compatible mode."	
Frontpanel	162	"Error"	"CSC is always disabled during transient in UPC compatible mode."	
Frontpanel	163	"Error"	"Auto RMS is always enabled in UPC compatible mode."	
Frontpanel	166	"Error"	"Unable to set extended voltage because frequency is outside the allowed range."	

Source	Code	Type	Description	Possible cause
Frontpanel	169	"Error"	"Unable to update setpoint because it is outside the allowed range of extended voltage mode."	
Frontpanel	172	"Error"	"Command not allowed during power stage firmware update."	
Frontpanel	173	"Error"	"Cannot change Current RMS Overload mode with output enabled."	
Frontpanel	174	"Error"	"Strobe feature not available in this model."	
Frontpanel	175	"Error"	"Feature not available in this model."	
Frontpanel	176	"Error"	"Setpoints cannot be changed while transient program is running."	
Frontpanel	177	"Error"	"Cycle reset is always enabled in UPC compatible mode."	
Frontpanel	178	"Error"	"Command not available in this unit model."	
Frontpanel	179	"Error"	"Digital output is being used for transformer option."	
Frontpanel	180	"Error"	"Unknown processor type detected. Run unit discovery to recover."	
Frontpanel	181	"Error"	"Undiscovered node detected. Run unit discovery to recover."	
Frontpanel	182	"Error"	"Incorrect parallel unit count"	
Frontpanel	183	"Error"	"Invalid processor type"	
Frontpanel	184	"Error"	"Daisy chain invalid type"	
Frontpanel	185	"Error"	"Undiscovered controller node was detected. "	
Frontpanel	186	"Error"	"No master front panel was detected."	
Frontpanel	187	"Error"	"More than enabled master controller is was detected. Going to inactive state."	
Frontpanel	188	"Error"	"One or more units are not energized or have a failure."	
Frontpanel	189	"Error"	"Incompatible node detected."	
Frontpanel	190	"Error"	"Master unit nodes not found."	
Frontpanel	191	"Error"	"Fastscan failed."	
Frontpanel	192	"Error"	"Undetectable node exists."	
Frontpanel	193	"Error"	"An invalid firmare type exists."	
Frontpanel	601	"Error"	"Frequency is too high to enable xfmr coupling."	
Frontpanel	602	"Error"	"Extended voltage range is not allowed when overload modes are enabled."	
Frontpanel	603	"Error"	"Frequency is too high for extended voltage mode."	
Frontpanel	604	"Error"	"Cannot change extended voltage mode with output enabled."	
Frontpanel	605	"Error"	"Cannot enable current overload mode when extended voltage range is enabled."	
Frontpanel	606	"Error"	"Cannot enable extended frequency when extended voltage range is enabled."	
Frontpanel	609	"Error"	"Setpoint out of range due to extended frequency mode."	

Source	Code	Type	Description	Possible cause
Frontpanel	610	"Error"	"Unable to update setpoint because it is outside the allowed range of extended frequency mode."	
Frontpanel	611	"Error"	"Error during power stage firmware update."	
Frontpanel	612	"Error"	"Phase rotation is always negative in UPC compatible mode."	
Frontpanel	613	"Error"	"Cannot change split phase mode with output enabled."	
Frontpanel	614	"Error"	"Serial port flow control not available in this unit."	
Frontpanel	615	"Error"	"Too many commands per line."	
Frontpanel	618	"Error"	"Cannot change output impedance state with output enabled."	
Frontpanel	619	"Error"	"Cannot change output impedance mode with output enabled."	
Frontpanel	620	"Error"	"Inductive impedance not available in UPC compatible mode."	
Frontpanel	621	"Error"	"Read only file or folder."	
Frontpanel	622	"Error"	"Argument requires more decimals."	
Frontpanel	624	"Error"	"Digital I/Os interface conflict: Serial interface is active."	
Frontpanel	625	"Error"	"New IO firmware available. Must split system in two to perform update."	
Frontpanel	626	"Error"	"Cannot export configurations."	
Frontpanel	627	"Error"	"Cannot import configurations."	
Frontpanel	628	"Error"	"Version mismatch error."	
Frontpanel	629	"Error"	"Internal connection error with the power stage."	
Frontpanel	630	"Error"	"Fault during output enable."	
Frontpanel	631	"Error"	"Cannot set this parameter for the selected mode."	
Frontpanel	632	"Error"	"Cannot convert cycle based transient to time based."	
Frontpanel	633	"Error"	"Incorrect password."	
Frontpanel	635	"Error"	"This setpoint is being set by an analog input."	
Frontpanel	636	"Error"	"Image model not compatible."	
Frontpanel	637	"Error"	"Frontpanel not compatible."	
Frontpanel	638	"Error"	"Cannot load pulse."	
Frontpanel	640	"Error"	"Parameter below minimum saturation."	
Frontpanel	641	"Error"	"Parameter below minimum range."	
Frontpanel	642	"Error"	"Parameter below minimum unit scope."	
Frontpanel	643	"Error"	"Parameter below minimum user limit."	
Frontpanel	644	"Error"	"Parameter below voltage mode."	
Frontpanel	645	"Error"	"Parameter above maximum saturation."	
Frontpanel	646	"Error"	"Parameter above maximum range."	
Frontpanel	647	"Error"	"Parameter above maximum unit scope."	

Source	Code	Type	Description	Possible cause
Frontpanel	648	"Error"	"Parameter above maximum user limit."	
Frontpanel	649	"Error"	"Parameter above voltage mode."	
Frontpanel	650	"Error"	"RT bus communication error"	It will use CAN when possible
Frontpanel	651	"Error"	"Folder does not exist."	
Frontpanel	652	"Error"	"File does not exist."	"
Frontpanel	655	"Error"	"Locked unit"	Please unlock with command SYST:UNLOCK PASSWORD
Frontpanel	656	"Error"	"Suffix not allowed in two independent outputs."	
Frontpanel	657	"Error"	"Error not available in current operating mode."	
Frontpanel	658	"Error"	"DC Current not allowed in "AC mode"."	
Frontpanel	659	"Error"	"AC Current not allowed in "DC mode"."	
Frontpanel	660	"Error"	"DC current setpoint cannot change due to user limit."	
Frontpanel	661	"Error"	"AC current setpoint cannot change due to user limit."	
Frontpanel	662	"Error"	"DC current setpoint cannot change due to range."	
Frontpanel	663	"Error"	"AC current setpoint cannot change due to range."	
Frontpanel	664	"Error"	"DC current setpoint cannot change due to waveform saturation."	
Frontpanel	665	"Error"	"AC current setpoint cannot change due to waveform saturation."	
Frontpanel	666	"Error"	"Command not available in this operating mode."	
Frontpanel	667	"Error"	"Unit model changed to ADF."	
Frontpanel	668	"Error"	"Waveform is in function mode."	
Frontpanel	671	"Error"	"Peak current protection is always enabled AZX model."	
Frontpanel	672	"Error"	"Peak voltage protection is always enabled this operating mode."	
Frontpanel	673	"Error"	"Analog controller relay control error."	
Frontpanel	674	"Error"	"Too high voltage present to enable relay."	
Frontpanel	675	"Error"	"Too high voltage present to switch range."	
Frontpanel	676	"Error"	"Too high voltage present to switch operating mode."	
Frontpanel	677	"Error"	"Too high voltage present to enable relay"	It will try to enable every five seconds."
Frontpanel	681	"Error"	"Module STX byte error."	
Frontpanel	682	"Error"	"Module tunneling RX error."	
Frontpanel	683	"Error"	"Module no reponse."	
Frontpanel	684	"Error"	"Module invalid memory location."	
Frontpanel	685	"Error"	"Module invalid response."	

Source	Code	Type	Description	Possible cause
Frontpanel	686	"Error"	"Module string parsing error."	
Frontpanel	687	"Error"	"Modules discovery error"	Missing subdevice
Frontpanel	688	"Error"	"Modules firmware update load file error."	
Frontpanel	689	"Error"	"Modules firmware update fault."	
Frontpanel	690	"Error"	"Too high voltage present to switch output capacitors."	
Frontpanel	691	"Error"	"Analog controller capacitors control error."	
Frontpanel	692	"Error"	"Analog controller current mode control error."	
Frontpanel	71	"Warning"	"Setpoint reduced due to low range."	
Frontpanel	107	"Warning"	"Redundant segments were combined."	
Frontpanel	108	"Warning"	"Redundant steps were combined."	
Frontpanel	144	"Warning"	"Internal battery needs to be replaced."	
Frontpanel	164	"Warning"	"Warning: CSC is enabled and Auto-RMS is disabled. Output RMS may not be regulated properly."	
Frontpanel	165	"Warning"	"Maximum AC voltage limit was reduced due to extended voltage range."	
Frontpanel	167	"Warning"	"Power limits were reduced due to extended voltage range."	
Frontpanel	168	"Warning"	"AC voltage setpoints and/or AC voltage maximum limit were reduced due to extended voltage range."	
Frontpanel	171	"Warning"	"Warning: Repeated waveform alias."	
Frontpanel	600	"Warning"	"AC voltage setpoint was automatically reduced to 0 Vrms."	
Frontpanel	607	"Warning"	"Power limits were reduced due to extended frequency mode."	
Frontpanel	608	"Warning"	"Current limits were reduced due to extended frequency mode."	
Frontpanel	616	"Warning"	"Resistive impedance was automatically reduced."	
Frontpanel	617	"Warning"	"Inductive impedance was automatically reduced."	
Frontpanel	623	"Warning"	"Warning: Ambient temperature approaching limit."	
Frontpanel	634	"Warning"	"Frontpanel firmware image model does not match frontpanel model."	
Frontpanel	653	"Warning"	"Unit in emulation mode."	
Frontpanel	654	"Warning"	"Feature disabled while interharmonic is enabled."	
Frontpanel	678	"Warning"	"Capacitive impedance was automatically reduced."	
Frontpanel	679	"Warning"	"Conductive impedance was automatically reduced."	
Frontpanel	680	"Warning"	"Operating mode not available in UPC compatible mode.."	
Frontpanel	331	"Fault"	"Unit discovery fault. Run unit discovery to recover."	
Frontpanel	332	"Fault"	"Undiscovered unit/node detected. Run unit discovery to recover."	

Source	Code	Type	Description	Possible cause
Frontpanel	334	"Fault"	"Power failure."	
Frontpanel	335	"Fault"	"Remote inhibit was issued from remote interface."	
Frontpanel	336	"Fault"	"System about to reboot."	
Frontpanel	338	"Fault"	"One or more enhanced controllers did not get enabled."	
Frontpanel	339	"Fault"	"One or more inverters did not get enabled."	
Frontpanel	340	"Fault"	"One or more primaries did not get enabled."	
Frontpanel	343	"Fault"	"Mismatch between hardware revision of units in parallel."	
Frontpanel	344	"Fault"	"Power stage firmware update failed. Run SYSTem:FW:INT:UPDATE:STAT? for more information. Run unit discovery to recover."	
Frontpanel	345	"Fault"	"Firmware update was interrupted"	Recovery is needed. Run unit discovery to recover
Frontpanel	346	"Fault"	"GPIB hardware not found in this unit."	
Frontpanel	347	"Fault"	"GPIB hardware detected"	Unit model mismatch
Frontpanel	348	"Fault"	"IO hardware not found in this unit."	
Frontpanel	349	"Fault"	"IO hardware detected"	Unit model mismatch.
Frontpanel	351	"Fault"	"Transformer hardware detected"	Unit model mismatch
Frontpanel	352	"Fault"	"Ambient temperature exceeded maximum limit."	
Frontpanel	353	"Fault"	"Enhanced controller hardware not found in this unit."	
Frontpanel	354	"Fault"	"Enhanced controller hardware detected"	Unit model mismatch
Frontpanel	355	"Fault"	"Mismatch between models of units in parallel."	
Frontpanel	356	"Fault"	"Unit model mismatch."	
Frontpanel	329	"Internal fault"	"Global fault detected."	
Frontpanel	330	"Internal fault"	"Global fault detected. Possible unenergized unit or node."	
Frontpanel	333	"Internal fault"	"Node in non-operational mode. Run unit discovery to recover."	
Frontpanel	337	"Internal fault"	"Missed node."	
Frontpanel	341	"Internal fault"	"Firmware version mismatch. Power stage version is older than expected. Contact technical support."	
Frontpanel	342	"Internal fault"	"Firmware version mismatch. Front panel version is older than expected. Contact technical support."	
Frontpanel	350	"Internal fault"	"Analog inputs cannot be read."	
Frontpanel	357	"Internal fault"	"Digital inputs cannot be read."	
Frontpanel	358	"Internal fault"	"Internal communication."	
Frontpanel	1	"Internal error"	"Unknown fault or error."	

Source	Code	Type	Description	Possible cause
Frontpanel	2	"Internal error"	"Cannot initialize command thread."	
Frontpanel	3	"Internal error"	"Cannot initialize global semaphore."	
Frontpanel	4	"Internal error"	"Cannot create SCPI status object."	
Frontpanel	5	"Internal error"	"Cannot create network manager object."	
Frontpanel	6	"Internal error"	"Cannot initialize CANOpen stack."	
Frontpanel	7	"Internal error"	"Cannot initialize process class array."	
Frontpanel	8	"Internal error"	"Cannot initialize local CANOpen object dictionary."	
Frontpanel	9	"Internal error"	"Cannot create FastCGI interface."	
Frontpanel	10	"Internal error"	"Cannot create TCP interface."	
Frontpanel	11	"Internal error"	"Cannot create TELNET interface."	
Frontpanel	12	"Internal error"	"Cannot create UART serial interface."	
Frontpanel	13	"Internal error"	"Cannot create USB serial interface."	
Frontpanel	14	"Internal error"	"Cannot create keyboard interface."	
Frontpanel	15	"Internal error"	"Cannot create front panel interface."	
Frontpanel	16	"Internal error"	"Cannot create SCPI program interface."	
Frontpanel	17	"Internal error"	"Cannot cast process class in runtime."	
Frontpanel	20	"Internal error"	"Unknown operation."	
Frontpanel	23	"Internal error"	"Unavailable node."	
Frontpanel	24	"Internal error"	"Cannot initialize GPIO library."	
Frontpanel	25	"Internal error"	"Process class: not implemented type."	
Frontpanel	25	"Internal error"	"Cannot attach GPIO."	
Frontpanel	26	"Internal error"	"Process class: invalid initialization."	
Frontpanel	27	"Internal error"	"SCPI program dynamic cast."	
Frontpanel	28	"Internal error"	"Cannot initialize node discovery."	
Frontpanel	38	"Internal error"	"Static null pointer."	
Frontpanel	39	"Internal error"	"Cannot create file system object"	
Frontpanel	40	"Internal error"	"Linux system call error"	
Frontpanel	41	"Internal error"	"XML library error."	
Frontpanel	43	"Internal error"	"Cannot create fault manager interface."	
Frontpanel	44	"Internal error"	"Global fault UIO driver."	
Frontpanel	45	"Internal error"	"Global fault interrupt disabled."	
Frontpanel	46	"Internal error"	"Cannot create global fault thread."	
Frontpanel	49	"Internal error"	"Cannot initialize communications reset mutex."	
Frontpanel	50	"Internal error"	"Cannot initialize communications reset condition variable."	
Frontpanel	52	"Internal error"	"Error in internal communications heartbeat."	
Frontpanel	55	"Internal error"	"Cannot initialize waveform manager."	
Frontpanel	61	"Internal error"	"Cannot initialize firmware update manager."	
Frontpanel	62	"Internal error"	"Cannot initialize buffer manager."	

Source	Code	Type	Description	Possible cause
Frontpanel	81	"Internal error"	"Internal error: Socket send error."	
Frontpanel	82	"Internal error"	"Internal error: Interface request packet has incorrect CRC."	
Frontpanel	87	"Internal error"	"Internal error: Cannot get system time."	
Frontpanel	88	"Internal error"	"Internal error: Unknown sequence."	
Frontpanel	93	"Internal error"	"Internal error: Cannot configure timer."	
Frontpanel	94	"Internal error"	"Internal error: Cannot create timer."	
Frontpanel	136	"Internal error"	"NVRAM CRC mismatch"	
Frontpanel	137	"Internal error"	"NVRAM cannot open."	
Frontpanel	138	"Internal error"	"NVRAM cannot close."	
Frontpanel	139	"Internal error"	"NVRAM cannot lock."	
Frontpanel	140	"Internal error"	"NVRAM cannot unlock."	
Frontpanel	141	"Internal error"	"NVRAM cannot read."	
Frontpanel	142	"Internal error"	"NVRAM cannot write."	
Frontpanel	143	"Internal error"	"Cannot reset EEPROM."	
Frontpanel	145	"Internal error"	"NVRAM hardware error. Using temporal storage."	
Frontpanel	146	"Internal error"	"Invalid command ID."	
Frontpanel	147	"Internal error"	"Command argument not exist."	
Frontpanel	149	"Internal error"	"This does not seems to be a front panel."	
Frontpanel	669	"Internal error"	"Configuration mismatch with analog controller."	
Frontpanel	670	"Internal error"	"Analog controller does not respond."	
Frontpanel	2000	"Internal error"	"Command request argument: argument cannot be null."	
Frontpanel	2001	"Internal error"	"Command request argument: cannot parse unknown argument."	
Frontpanel	2002	"Internal error"	"Command request argument: cannot parse argument."	
Frontpanel	2003	"Internal error"	"Command request argument: cannot append string to non string argument."	
Frontpanel	2004	"Internal error"	"Command request argument: cannot serialize due to small buffer."	
Frontpanel	2005	"Internal error"	"Command request argument: cannot deserialize due to small buffer."	
Frontpanel	2006	"Internal error"	"Command request argument: cannot get string due non string argument."	
Frontpanel	2007	"Internal error"	"EEPROM Data: Write header error."	
Frontpanel	2008	"Internal error"	"EEPROM Data: Write data error."	
Frontpanel	2009	"Internal error"	"EEPROM Data: Data too big."	
Frontpanel	2010	"Internal error"	"EEPROM Data: Cannot open temporal file."	
Frontpanel	2011	"Internal error"	"EEPROM Data: Close error."	
Frontpanel	2012	"Internal error"	"EEPROM Data: Offset error."	
Frontpanel	2013	"Internal error"	"EEPROM Data: Read error."	
Frontpanel	2014	"Internal error"	"Transformer: Corrupted internal database."	

Source	Code	Type	Description	Possible cause
Frontpanel	2015	"Internal error"	"XFMR ratio not found."	
Frontpanel	2016	"Internal error"	"Coupling cannot be changed with output enabled."	
Frontpanel	2017	"Internal error"	"XFMR ratio cannot be changed with output enabled."	
Frontpanel	2018	"Internal error"	"Transformer option not available in this model."	
Frontpanel	2019	"Internal error"	"XFMR ratio is disabled. A XFMR ratio should be set with SYSTEM:XFMR RATIO command."	
Frontpanel	2020	"Internal error"	"Transformer control circuits not detected."	
Frontpanel	2021	"Internal error"	"DC voltage not allowed with transformer coupling."	
Frontpanel	2022	"Internal error"	"Command request: command request cannot be null."	
Frontpanel	2023	"Internal error"	"Command request: command request argument is null."	
Frontpanel	2024	"Internal error"	"Command request: argument is null."	
Frontpanel	2025	"Internal error"	"Command request: argument number is null."	
Frontpanel	2026	"Internal error"	"Command request: argument number does not exist."	
Frontpanel	2027	"Internal error"	"Command request: there are no arguments."	
Frontpanel	2028	"Internal error"	"Command request: cannot serialize due small buffer."	
Frontpanel	2029	"Internal error"	"Command request: cannot deserialize due small buffer."	
Frontpanel	2030	"Internal error"	"Command request: cannot deserialize due argument count mismatch."	
Frontpanel	2031	"Internal error"	"Command request: cannot deserialize due size mismatch."	
Frontpanel	2032	"Internal error"	"Command request vector: request number does not exist."	
Frontpanel	2033	"Internal error"	"Command request vector: request number is null."	
Frontpanel	2034	"Internal error"	"Command request vector: request is null."	
Frontpanel	2035	"Internal error"	"Command request vector: vector is empty."	
Frontpanel	2036	"Internal error"	"Command request vector: cannot serialize due small buffer."	
Frontpanel	2037	"Internal error"	"Command request vector: cannot deserialize due small buffer."	
Frontpanel	2038	"Internal error"	"Command request vector: cannot deserialize due command count mismatch."	
Frontpanel	2039	"Internal error"	"Command request vector: cannot deserialize due size mismatch."	
Frontpanel	2040	"Internal error"	"Interface request packet: cannot deserialize due size mismatch."	
Frontpanel	2041	"Internal error"	"Command thread: cannot post command semaphore."	
Frontpanel	2042	"Internal error"	"Command thread: cannot initialize command semaphore."	
Frontpanel	2043	"Internal error"	"Debug message file: seek file error."	

Source	Code	Type	Description	Possible cause
Frontpanel	2044	"Internal error"	"Debug message file: tell file error."	
Frontpanel	2045	"Internal error"	"Debug message file: close file error."	
Frontpanel	2046	"Internal error"	"Debug message file: open file error."	
Frontpanel	2047	"Internal error"	"Debug message file: write file error."	
Frontpanel	2048	"Internal error"	"Debug message file: flush file error."	
Frontpanel	2049	"Internal error"	"Debug message file: unlink file error."	
Frontpanel	2050	"Internal error"	"Debug message ring buffer: cannot allocate buffer."	
Frontpanel	2051	"Internal error"	"Debug message ring buffer: seek file error."	
Frontpanel	2052	"Internal error"	"Debug message ring buffer: tell file error."	
Frontpanel	2053	"Internal error"	"Debug message ring buffer: close file error."	
Frontpanel	2054	"Internal error"	"Debug message ring buffer: open file error."	
Frontpanel	2055	"Internal error"	"Debug message ring buffer: write file error."	
Frontpanel	2056	"Internal error"	"Debug message ring buffer: flush file error."	
Frontpanel	2057	"Internal error"	"Debug message ring buffer: unlink file error."	
Frontpanel	2058	"Internal error"	"Debug message system: print error failed."	
Frontpanel	2059	"Internal error"	"Debug message system: print output failed."	
Frontpanel	2060	"Internal error"	"Debug: cannot get core limit."	
Frontpanel	2061	"Internal error"	"Debug: cannot set core limit."	
Frontpanel	2062	"Internal error"	"Debug: cannot initialize mutex attributes."	
Frontpanel	2063	"Internal error"	"Debug: cannot set mutex attributes."	
Frontpanel	2064	"Internal error"	"Debug: cannot initialize mutex."	
Frontpanel	2065	"Internal error"	"Debug: cannot destroy mutex."	
Frontpanel	2066	"Internal error"	"Debug: cannot lock mutex."	
Frontpanel	2067	"Internal error"	"Debug: cannot unlock mutex."	
Frontpanel	2068	"Internal error"	"Debug: cannot allocate debug message system."	
Frontpanel	2069	"Internal error"	"Debug: cannot allocate debug message ring buffer."	
Frontpanel	2070	"Internal error"	"Debug: cannot allocate debug message file."	
Frontpanel	2071	"Internal error"	"Timer: cannot initialize mutex attributes."	
Frontpanel	2072	"Internal error"	"Timer: cannot set mutex attributes."	
Frontpanel	2073	"Internal error"	"Timer: cannot initialize mutex."	
Frontpanel	2074	"Internal error"	"Timer: cannot destroy mutex."	
Frontpanel	2075	"Internal error"	"Timer: cannot lock mutex."	
Frontpanel	2076	"Internal error"	"Timer: cannot unlock mutex."	
Frontpanel	2077	"Internal error"	"Timer: cannot allocate mark."	
Frontpanel	2078	"Internal error"	"Timer: cannot get time."	

Source	Code	Type	Description	Possible cause
Frontpanel	2079	"Internal error"	"Timing: cannot initialize mutex attributes."	
Frontpanel	2080	"Internal error"	"Timing: cannot set mutex attributes."	
Frontpanel	2081	"Internal error"	"Timing: cannot initialize mutex."	
Frontpanel	2082	"Internal error"	"Timing: cannot destroy mutex."	
Frontpanel	2083	"Internal error"	"Timing: cannot lock mutex."	
Frontpanel	2084	"Internal error"	"Timing: cannot unlock mutex."	
Frontpanel	2085	"Internal error"	"Timing: cannot allocate timer."	
Frontpanel	2086	"Internal error"	"Timing: timer not found."	
Frontpanel	2087	"Internal error"	"Command response item: cannot get string of non string type."	
Frontpanel	2088	"Internal error"	"Command response item: cannot get two items."	
Frontpanel	2089	"Internal error"	"Command response item: cannot get three items."	
Frontpanel	2090	"Internal error"	"Command response item: cannot get item."	
Frontpanel	2091	"Internal error"	"Command response item: cannot set null item."	
Frontpanel	2092	"Internal error"	"Command response item: cannot set item with null data."	
Frontpanel	2093	"Internal error"	"Command response item: cannot set null item vector."	
Frontpanel	2094	"Internal error"	"Command response item: cannot append item of different type."	
Frontpanel	2095	"Internal error"	"Command response item: item not compatible."	
Frontpanel	2096	"Internal error"	"Command response item: cannot serialize due small buffer."	
Frontpanel	2097	"Internal error"	"Command response item: cannot deserialize due small buffer."	
Frontpanel	2098	"Internal error"	"Command response vector: vector is empty."	
Frontpanel	2099	"Internal error"	"Command response vector: last response is null."	
Frontpanel	2100	"Internal error"	"Command response vector: response does not exist."	
Frontpanel	2101	"Internal error"	"Command response vector: cannot serialize due small buffer"	
Frontpanel	2102	"Internal error"	"Command response vector: cannot deserialize due response count mismatch."	
Frontpanel	2103	"Internal error"	"Command response vector: cannot deserialize due size mismatch."	
Frontpanel	2104	"Internal error"	"Command response: cannot set null response."	
Frontpanel	2105	"Internal error"	"Command response: cannot append null data."	
Frontpanel	2106	"Internal error"	"Command response: vector is empty."	
Frontpanel	2107	"Internal error"	"Command response: last item is null."	
Frontpanel	2108	"Internal error"	"Command response: item does not exist."	
Frontpanel	2109	"Internal error"	"Command response: cannot serialize due small buffer."	

Source	Code	Type	Description	Possible cause
Frontpanel	2110	"Internal error"	"Command response: cannot deserialize due item count mismatch."	
Frontpanel	2111	"Internal error"	"Command response: cannot deserialize due size mismatch."	
Frontpanel	2112	"Internal error"	"Interface response packet: cannot convert due small buffer."	
Frontpanel	2113	"Internal error"	"Interface response packet: cannot deserialize due size mismatch."	
Frontpanel	2114	"Internal error"	"DB9 GPIOs: owner not allowed."	
Frontpanel	2115	"Internal error"	"Signals: system call sigemptyset."	
Frontpanel	2116	"Internal error"	"Signals: system call sigaddset."	
Frontpanel	2117	"Internal error"	"Signals: system call pthread_sigmask."	
Frontpanel	2118	"Internal error"	"Signals: system call sigaction."	
Frontpanel	2119	"Internal error"	"Signals: cannot initialize destructor semaphore."	
Frontpanel	2120	"Internal error"	"Signals: cannot destroy destructor semaphore."	
Frontpanel	2121	"Internal error"	"Thread: cannot initialize mutex."	
Frontpanel	2122	"Internal error"	"Thread: cannot create thread."	
Frontpanel	2123	"Internal error"	"Thread: cannot cancel thread."	
Frontpanel	2124	"Internal error"	"Thread: cannot join thread."	
Frontpanel	2125	"Internal error"	"NVRAM: field is not double."	
Frontpanel	2126	"Internal error"	"NVRAM: field is not bool."	
Frontpanel	2127	"Internal error"	"NVRAM: field is not unsigned char."	
Frontpanel	2128	"Internal error"	"XML file: default document is null."	
Frontpanel	2129	"Internal error"	"XML file: cannot lock mutex."	
Frontpanel	2130	"Internal error"	"XML file: cannot unlock mutex."	
Frontpanel	2131	"Internal error"	"XML file: cannot lock file."	
Frontpanel	2132	"Internal error"	"XML file: cannot truncate file."	
Frontpanel	2133	"Internal error"	"XML file: cannot seek file."	
Frontpanel	2134	"Internal error"	"XML file: cannot write file."	
Frontpanel	2135	"Internal error"	"XML file: cannot flush file."	
Frontpanel	2136	"Internal error"	"XML file: cannot sync file."	
Frontpanel	2137	"Internal error"	"XML file: cannot initialize mutex attributes."	
Frontpanel	2138	"Internal error"	"XML file: cannot set mutex attribute."	
Frontpanel	2139	"Internal error"	"XML file: cannot initialize mutex."	
Frontpanel	2140	"Internal error"	"XML file: cannot unlink file."	
Frontpanel	2141	"Internal error"	"XML file: cannot convert to double."	
Frontpanel	2142	"Internal error"	"XML file: cannot convert to float."	
Frontpanel	2143	"Internal error"	"XML file: cannot convert to int."	
Frontpanel	2144	"Internal error"	"XML file: cannot convert to unsigned int."	
Frontpanel	2145	"Internal error"	"XML file: cannot convert to bool."	
Frontpanel	2146	"Internal error"	"XML file: cannot convert attribute."	

Source	Code	Type	Description	Possible cause
Frontpanel	2147	"Internal error"	"XML file: cannot convert attribute to bool"	
Frontpanel	2148	"Internal error"	"XML file: document is null."	
Frontpanel	2149	"Internal error"	"XML file: element is null."	
Frontpanel	2150	"Internal error"	"XML file: element data is null."	
Frontpanel	2151	"Internal error"	"XML file: attribute is null."	
Frontpanel	2152	"Internal error"	"XML file: attribute data is null."	
Frontpanel	2153	"Internal error"	"XML file: system call access failed."	
Frontpanel	2154	"Internal error"	"XML file: cannot rename file."	
Frontpanel	2155	"Internal error"	"XML file: cannot allocate document."	
Frontpanel	2156	"Internal error"	"XML file: CRC mismatch."	
Frontpanel	2157	"Internal error"	"XML file: version mismatch."	
Frontpanel	2158	"Internal error"	"XML file: cannot amend file."	
Frontpanel	2159	"Internal error"	"XML file: data out of range."	
Frontpanel	2160	"Internal error"	"XML file: cannot insert element."	
Frontpanel	2161	"Internal error"	"XML file: cannot clone element."	
Frontpanel	2162	"Internal error"	"CAN interface: cannot initialize mutex."	
Frontpanel	2163	"Internal error"	"CAN open stack: cannot initialize running mutex."	
Frontpanel	2164	"Internal error"	"CAN open stack: cannot initialize reset mutex."	
Frontpanel	2165	"Internal error"	"CAN open stack: cannot initialize CO mutex."	
Frontpanel	2166	"Internal error"	"CAN open stack: cannot initialize READ mutex."	
Frontpanel	2167	"Internal error"	"CAN open stack: cannot destroy CO mutex."	
Frontpanel	2168	"Internal error"	"CAN open stack: cannot destroy reset mutex."	
Frontpanel	2169	"Internal error"	"CAN open stack: cannot destroy running mutex."	
Frontpanel	2170	"Internal error"	"CAN open stack: cannot initialize CO."	
Frontpanel	2171	"Internal error"	"CAN open stack: cannot create timer thread."	
Frontpanel	2172	"Internal error"	"CAN open stack: cannot create RX thread."	
Frontpanel	2173	"Internal error"	"CAN open stack: cannot CAN socket."	
Frontpanel	2174	"Internal error"	"CAN open stack: cannot configure CAN socket."	
Frontpanel	2175	"Internal error"	"CAN open stack: cannot bind CAN socket."	
Frontpanel	2176	"Internal error"	"CAN open stack: cannot close CAN socket."	
Frontpanel	2177	"Internal error"	"CAN open stack: cannot write CAN socket."	
Frontpanel	2178	"Internal error"	"CAN open stack: write CAN socket size mismatch."	
Frontpanel	2179	"Internal error"	"CAN open stack: CAN socket not initialized."	
Frontpanel	2180	"Internal error"	"CAN open stack: cannot initialize CO timer semaphore."	

Source	Code	Type	Description	Possible cause
Frontpanel	2181	"Internal error"	"CAN open stack: cannot destroy CO timer semaphore."	
Frontpanel	2182	"Internal error"	"CAN main: cannot initialize background semaphore mutex."	
Frontpanel	2183	"Internal error"	"CAN main: cannot destroy background semaphore mutex."	
Frontpanel	2184	"Internal error"	"CAN main: cannot initialize background semaphore."	
Frontpanel	2185	"Internal error"	"CAN main: cannot destroy background semaphore."	
Frontpanel	2186	"Internal error"	"Discovery: cannot initialize daisy chain GPIO."	
Frontpanel	2187	"Internal error"	"Discovery: daisy chain GPIO not initialized."	
Frontpanel	2188	"Internal error"	"Discovery: cannot get processor types due small vector."	
Frontpanel	2189	"Internal error"	"Discovery: cannot get inverters due small vector."	
Frontpanel	2190	"Internal error"	"Discovery: cannot get primaries due small vector."	
Frontpanel	2191	"Internal error"	"Discovery: cannot allocate discovery."	
Frontpanel	2192	"Internal error"	"DSP commands: NMT."	
Frontpanel	2193	"Internal error"	"DSP commands: SDO download."	
Frontpanel	2194	"Internal error"	"DSP commands: SDO upload."	
Frontpanel	2195	"Internal error"	"DSP commands: LSS INCRS."	
Frontpanel	2196	"Internal error"	"DSP commands: LSS SSDC."	
Frontpanel	2197	"Internal error"	"DSP commands: LSS CNI."	
Frontpanel	2198	"Internal error"	"DSP commands: LSS SC."	
Frontpanel	2199	"Internal error"	"DSP commands: LSS FS."	
Frontpanel	2200	"Internal error"	"DSP commands: LSS PPSTFS."	
Frontpanel	2201	"Internal error"	"DSP commands: invalid node ID."	
Frontpanel	2202	"Internal error"	"DSP commands: invalid DSP type."	
Frontpanel	2203	"Internal error"	"DSP commands: invalid mapping number."	
Frontpanel	2204	"Internal error"	"DSP commands: invalid COB ID."	
Frontpanel	2205	"Internal error"	"DSP commands: invalid heart beat number."	
Frontpanel	2206	"Internal error"	"DSP commands: invalid tries number."	
Frontpanel	2207	"Internal error"	"DSP commands: read SDO buffer length."	
Frontpanel	2208	"Internal error"	"DSP commands: read bootloader DSP types."	
Frontpanel	2209	"Internal error"	"DSP commands: read bootloader state."	
Frontpanel	2210	"Internal error"	"DSP update commands: flag for update."	
Frontpanel	2211	"Internal error"	"DSP update commands: check device type."	
Frontpanel	2212	"Internal error"	"DSP update commands: check bootloader update state."	
Frontpanel	2213	"Internal error"	"DSP update commands: unlock flash CSM."	
Frontpanel	2214	"Internal error"	"DSP update commands: lock flash CSM."	

Source	Code	Type	Description	Possible cause
Frontpanel	2215	"Internal error"	"DSP update commands: erase flash sector."	
Frontpanel	2216	"Internal error"	"DSP update commands: write flash block."	
Frontpanel	2217	"Internal error"	"DSP update commands: firmware run."	
Frontpanel	2218	"Internal error"	"Condition comparison: unknown condition."	
Frontpanel	2219	"Internal error"	"Observer program: SCPI program not initialized."	
Frontpanel	2220	"Internal error"	"Command vector: invalid initialization order."	
Frontpanel	2221	"Internal error"	"Command vector: incomplete initialization."	
Frontpanel	2222	"Internal error"	"Observer vector: invalid initialization order."	
Frontpanel	2223	"Internal error"	"Observer vector: incomplete initialization."	
Frontpanel	2224	"Internal error"	"Operation file system: XML file not initialized."	
Frontpanel	2225	"Internal error"	"Operation SDO: cannot get node ID."	
Frontpanel	2226	"Internal error"	"Operation generic: command ID vector empty."	
Frontpanel	2227	"Internal error"	"Operation IEEE4882: long IDN string."	
Frontpanel	2228	"Internal error"	"Operation system: DB9 GPIOs invalid state."	
Frontpanel	2229	"Internal error"	"Operation source: DB9 GPIOs invalid state."	
Frontpanel	2230	"Internal error"	"Operation source: waveform invalid state."	
Frontpanel	2231	"Internal error"	"Operation source: XML configuration file not initialized."	
Frontpanel	2232	"Internal error"	"Operation source: XML program file not initialized."	
Frontpanel	2233	"Internal error"	"Operation simulation: invalid variable ID."	
Frontpanel	2234	"Internal error"	"Operation program: invalid transient status"	
Frontpanel	2235	"Internal error"	"Operation program: command not available."	
Frontpanel	2236	"Internal error"	"Firmware update manager: firmware up to date."	
Frontpanel	2237	"Internal error"	"DSP firmware update log: mutex lock error."	
Frontpanel	2238	"Internal error"	"DSP firmware update log: mutex unlock error."	
Frontpanel	2239	"Internal error"	"DSP firmware update log: error opening log file."	
Frontpanel	2240	"Internal error"	"DSP firmware update log: error flushing log file."	
Frontpanel	2241	"Internal error"	"DSP firmware update log: error closing log file."	
Frontpanel	2242	"Internal error"	"DSP firmware update log: error writing log file."	
Frontpanel	2243	"Internal error"	"DSP firmware update log: no file open to write."	
Frontpanel	2244	"Internal error"	"DSP firmware update log: class null."	
Frontpanel	2245	"Internal error"	"Application: invalid application command."	

Source	Code	Type	Description	Possible cause
Frontpanel	2246	"Internal error"	"Application: cannot initialize running mutex."	
Frontpanel	2247	"Internal error"	"Application: cannot initialize application mutex."	
Frontpanel	2248	"Internal error"	"Application: cannot create timer."	
Frontpanel	2249	"Internal error"	"Application: cannot configure timer."	
Frontpanel	2250	"Internal error"	"Application: cannot close timer."	
Frontpanel	2251	"Internal error"	"XML handler: cannot load XML."	
Frontpanel	2252	"Internal error"	"Application: cannot save XML."	
Frontpanel	2253	"Internal error"	"Avahi XML: folder does not exist."	
Frontpanel	2254	"Internal error"	"Avahi XML: file does not exist."	
Frontpanel	2255	"Internal error"	"Avahi XML: invalid field number."	
Frontpanel	2256	"Internal error"	"Network manager: thread not initialized."	
Frontpanel	2257	"Internal error"	"Network manager: invalid variable ID."	
Frontpanel	2258	"Internal error"	"Network manager: invalid configuration type."	
Frontpanel	2259	"Internal error"	"Network manager: netconfig call failed."	
Frontpanel	2260	"Internal error"	"Network manager: avahi call failed."	
Frontpanel	2261	"Internal error"	"Network manager: udhcp call failed."	
Frontpanel	2262	"Internal error"	"Network manager: netconfig field not found."	
Frontpanel	2263	"Internal error"	"Network manager: invalid service name."	
Frontpanel	2264	"Internal error"	"Network manager: avahi close process."	
Frontpanel	2265	"Internal error"	"External interface: invalid socket path."	
Frontpanel	2266	"Internal error"	"External interface: cannot create from socket."	
Frontpanel	2267	"Internal error"	"External interface: cannot bind from socket."	
Frontpanel	2268	"Internal error"	"External interface: cannot listen from socket."	
Frontpanel	2269	"Internal error"	"External interface: cannot create to socket."	
Frontpanel	2270	"Internal error"	"External interface: cannot bind to socket."	
Frontpanel	2271	"Internal error"	"External interface: cannot listen to socket."	
Frontpanel	2272	"Internal error"	"External interface: cannot initialize to socket mutex."	
Frontpanel	2273	"Internal error"	"External interface: cannot allocate thread."	
Frontpanel	2274	"Internal error"	"External interface: invalid packet type."	
Frontpanel	2275	"Internal error"	"External interface: invalid response type."	
Frontpanel	2276	"Internal error"	"XML SCPI program file: buffer is null."	
Frontpanel	2277	"Internal error"	"XML SCPI program file: buffer is small."	
Frontpanel	2278	"Internal error"	"Program is undefined."	
Frontpanel	2279	"Internal error"	"XML SCPI program file: element is null."	
Frontpanel	2280	"Internal error"	"EEPROM: call failed."	
Frontpanel	2281	"Internal error"	"EEPROM: field not found."	

Source	Code	Type	Description	Possible cause
Frontpanel	2282	"Internal error"	"Memories: invalid folder."	
Frontpanel	2283	"Internal error"	"Memories: invalid name."	
Frontpanel	2284	"Internal error"	"XML access file: invalid IP."	
Frontpanel	2285	"Internal error"	"XML access file: invalid alias size."	
Frontpanel	2286	"Internal error"	"XML access file: cannot convert to bool."	
Frontpanel	2287	"Internal error"	"XML access file: invalid tag."	
Frontpanel	2288	"Internal error"	"Temperature: cannot open file."	
Frontpanel	2289	"Internal error"	"Temperature: file not opened."	
Frontpanel	2290	"Internal error"	"Temperature: cannot seek file."	
Frontpanel	2291	"Internal error"	"Temperature: cannot read file."	
Frontpanel	2292	"Internal error"	"Remote: DB9 GPIO not initialized."	
Frontpanel	2293	"Internal error"	"Remote: cannot open UIO."	
Frontpanel	2294	"Internal error"	"Remote: cannot write UIO."	
Frontpanel	2295	"Internal error"	"Interface vector: cannot initialize mutex attributes."	
Frontpanel	2296	"Internal error"	"Interface vector: cannot set mutex attributes."	
Frontpanel	2297	"Internal error"	"Interface vector: cannot initialize mutex."	
Frontpanel	2298	"Internal error"	"Interface vector: cannot allocate VXI interface."	
Frontpanel	2299	"Internal error"	"Interface vector: cannot lock mutex."	
Frontpanel	2300	"Internal error"	"Interface vector: cannot unlock mutex."	
Frontpanel	2301	"Internal error"	"SCPI program: destination program cannot be manual mode."	
Frontpanel	2302	"Internal error"	"SCPI program: invalid define string."	
Frontpanel	2303	"Internal error"	"SCPI program: missing voltage A."	
Frontpanel	2304	"Internal error"	"SCPI program: missing voltage B."	
Frontpanel	2305	"Internal error"	"Cannot get waveform field."	
Frontpanel	2306	"Internal error"	"Cannot delete waveform in use."	
Frontpanel	2307	"Internal error"	"Waveform #1 cannot be deleted or modified."	
Frontpanel	2308	"Internal error"	"Waveform #0 cannot be deleted or modified."	
Frontpanel	2309	"Internal error"	"Sequential interface: cannot initialize command executed semaphore."	
Frontpanel	2310	"Internal error"	"Sequential interface: cannot initialize execute command semaphore."	
Frontpanel	2311	"Internal error"	"Sequential interface: cannot initialize pending commands mutex."	
Frontpanel	2312	"Internal error"	"IEEE488.2 status: cannot initialize mutex."	
Frontpanel	2313	"Internal error"	"IEEE488.2 status: item does not exist."	
Frontpanel	2314	"Internal error"	"Fault manager: MDO not received."	
Frontpanel	2315	"Internal error"	"Measurement logger manager: cannot write file."	
Frontpanel	2316	"Internal error"	"Synchronization: cannot initialize operation complete mutex."	

Source	Code	Type	Description	Possible cause
Frontpanel	2317	"Internal error"	"Synchronization: cannot initialize operation complete mutex attributes."	
Frontpanel	2318	"Internal error"	"Synchronization: cannot set operation complete mutex attributes."	
Frontpanel	2319	"Internal error"	"Synchronization: cannot initialize operation complete condition variable."	
Frontpanel	2320	"Internal error"	"SCPI parser: cannot initialize mutex."	
Frontpanel	2321	"Internal error"	"SCPI parser: cannot lock mutex."	
Frontpanel	2322	"Internal error"	"SCPI parser: cannot unlock mutex."	
Frontpanel	2323	"Internal error"	"RT Bus packet: out of space."	
Frontpanel	2324	"Internal error"	"RT Bus packet: CRC mismatch."	
Frontpanel	2325	"Internal error"	"RT Bus packet: incomplete."	
Frontpanel	2326	"Internal error"	"RT Bus send: cannot init semaphore."	
Frontpanel	2327	"Internal error"	"RT Bus send: cannot destroy semaphore."	
Frontpanel	2328	"Internal error"	"RT Bus send: mutex lock."	
Frontpanel	2329	"Internal error"	"RT Bus send: mutex unlock."	
Frontpanel	2330	"Internal error"	"RT Bus send: mutex init attributes."	
Frontpanel	2331	"Internal error"	"RT Bus send: mutex set attributes."	
Frontpanel	2332	"Internal error"	"RT Bus send: mutex init."	
Frontpanel	2333	"Internal error"	"RT Bus send: executing."	
Frontpanel	2334	"Internal error"	"RT Bus send: timeout."	
Frontpanel	2344	"Internal error"	"RT Bus driver: not initialized."	
Frontpanel	2345	"Internal error"	"RT Bus driver: mutex init attributes."	
Frontpanel	2346	"Internal error"	"RT Bus driver: mutex set attributes."	
Frontpanel	2347	"Internal error"	"RT Bus driver: mutex init."	
Frontpanel	2348	"Internal error"	"RT Bus driver: mutex destroy."	
Frontpanel	2349	"Internal error"	"RT Bus driver: mutex lock."	
Frontpanel	2350	"Internal error"	"RT Bus driver: mutex unlock."	
Frontpanel	2351	"Internal error"	"RT Bus driver: cannot add transaction to queue."	
Frontpanel	2352	"Internal error"	"RT Bus driver: cannot start."	
Frontpanel	2353	"Internal error"	"RT Bus driver: cannot stop."	
Frontpanel	2354	"Internal error"	"RT Bus driver: UART for node not available."	
Frontpanel	2355	"Internal error"	"RT Bus driver: queue full."	
Frontpanel	2356	"Internal error"	"RT Bus driver: cannot add to queue."	
Frontpanel	2357	"Internal error"	"RT Bus driver: cannot post semaphore."	
Frontpanel	2358	"Internal error"	"RT Bus transaction: cannot init semaphore."	
Frontpanel	2359	"Internal error"	"RT Bus transaction: cannot destroy semaphore."	
Frontpanel	2360	"Internal error"	"RT Bus transaction: executing."	
Frontpanel	2361	"Internal error"	"RTC: not initialized."	
Frontpanel	2362	"Internal error"	"RTC: mutex init attributes."	

Source	Code	Type	Description	Possible cause
Frontpanel	2363	"Internal error"	"RTC: mutex set attributes."	
Frontpanel	2364	"Internal error"	"RTC: mutex init."	
Frontpanel	2365	"Internal error"	"RTC: mutex destroy."	
Frontpanel	2366	"Internal error"	"RTC: mutex lock."	
Frontpanel	2367	"Internal error"	"RTC: mutex unlock."	
Frontpanel	2368	"Internal error"	"RTC: cannot add transaction to queue."	
Frontpanel	2369	"Internal error"	"RTC: cannot start."	
Frontpanel	2370	"Internal error"	"RTC: cannot stop."	
Frontpanel	2371	"Internal error"	"RTC: cannot post semaphore."	
Frontpanel	113	"Internal warning"	"Missed second heartbeat."	
Frontpanel	114	"Internal warning"	"Missed first heartbeat."	
Frontpanel	123	"Internal warning"	"Warning: input voltage in EEPROM does not match the Primary DSP. Using DSP value."	
Frontpanel	0	"Success"	"No error"	
Inverter	265	"Fault"	"Inverter gate driver fault."	
Inverter	266	"Fault"	"Internal bias supply fault."	
Inverter	267	"Fault"	"No waveform loaded. Load waveform before enabling arbitrary waveform mode."	
Inverter	268	"Fault"	"Exceeded RMS current limit."	
Inverter	269	"Fault"	"Exceeded active power limit."	
Inverter	270	"Fault"	"Exceeded apparent power limit."	
Inverter	271	"Fault"	"Internal SCIA communication error."	
Inverter	272	"Fault"	"Internal McBSP communication CRC error."	
Inverter	273	"Fault"	"Inverter current negative peak protection."	
Inverter	274	"Fault"	"Inverter current positive peak protection."	
Inverter	275	"Fault"	"DC bus voltage minimum limit exceeded."	
Inverter	276	"Fault"	"DC bus voltage maximum limit exceeded."	
Inverter	277	"Fault"	"Temperature protection"	Maximum limit
Inverter	278	"Fault"	"Temperature protection"	Minimum limit
Inverter	279	"Fault"	"Output relay voltage protection"	Maximum limit
Inverter	280	"Fault"	"Output relay voltage protection"	Minimum limit
Inverter	281	"Fault"	"Output terminals common mode voltage protection"	Minimum limit
Inverter	282	"Fault"	"Output terminals common mode voltage protection"	Maximum limit
Inverter	283	"Fault"	"Inductor current RMS protection"	Exceeded maximum limit for too long
Inverter	284	"Fault"	"Inductor current DC protection"	Exceeded maximum limit for too long
Inverter	285	"Fault"	"Global fault input signal detected."	
Inverter	286	"Fault"	"Fan under voltage protection."	

Source	Code	Type	Description	Possible cause
Inverter	287	"Fault"	"Inductor current cycle-by-cycle protection trip limit."	
Inverter	288	"Fault"	"Fan current consumption is abnormal"	Fan may be blocked
Inverter	292	"Fault"	"Output current has too much high frequency content"	Possible oscillation. RQ monitor fault
Inverter	293	"Fault"	"Controller missed heartbeats from master front panel."	
Inverter	294	"Fault"	"Output over-voltage protection."	
Inverter	296	"Fault"	"Output current peak protection."	
Inverter	297	"Fault"	"Remote voltage sensing fault."	
Inverter	298	"Fault"	"Internal capacitors over-current protection."	
Inverter	299	"Fault"	"Internal bus over-voltage protection. Possible regenerative load."	
Inverter	300	"Fault"	"CSC loop has saturated"	
Inverter	301	"Fault"	"Output current overload. RMS current exceeded limit."	
Inverter	302	"Fault"	"Internal muxed ADC protection fault."	
Inverter	303	"Fault"	"Internal fan current regulation fault."	
Inverter	304	"Fault"	"Parallel units model mismatch."	
Inverter	305	"Fault"	"Under voltage protection."	
Inverter	306	"Fault"	"Over voltage protection."	
Inverter	307	"Fault"	"Constant power overvoltage."	
Inverter	289	"Internal fault"	"Hardware revision does not match expected by firmware. Firmware must be reloaded."	
Inverter	290	"Internal fault"	"Invalid node ID. Run unit discovery to recover."	
Inverter	291	"Internal fault"	"Incorrect DSP type detected. Cycle-power to re-try."	
Inverter	295	"Internal fault"	"Invalid constants loaded from EEPROM."	
Inverter	326	"Internal fault"	"Controller is not in operational node."	
Inverter	327	"Internal fault"	"Missing controller node."	
Inverter	328	"Internal fault"	"Cannot read fault information."	
Primary	200	"Fault"	"LLC primary/auxiliary current peak limit exceeded."	
Primary	201	"Fault"	"LLC/PFC gate driver fault or hardware OVP."	
Primary	202	"Fault"	"Controller missed heartbeats from master front panel."	
Primary	203	"Fault"	"LLC primary current average limit exceeded."	
Primary	204	"Fault"	"LLC auxiliary current average limit exceeded."	
Primary	205	"Fault"	"PFC current peak limit exceeded."	
Primary	206	"Fault"	"PFC DC bus voltage limit exceeded."	
Primary	207	"Fault"	"Gate driver fault"	Input buck converter

Source	Code	Type	Description	Possible cause
Primary	208	"Fault"	"Input buck switching time."	
Primary	209	"Fault"	"AC input current exceeded RMS limit for too long."	
Primary	210	"Fault"	"Unbalanced current in PFC boost converters."	
Primary	211	"Fault"	"PFC efficiency protection."	
Primary	212	"Fault"	"AC input: voltage is below minimum."	
Primary	213	"Fault"	"AC input: missing phase."	
Primary	214	"Fault"	"PFC DC bus voltage regulation lost."	
Primary	215	"Fault"	"PFC DC bus voltage limit exceeded. CLA OVP Trip"	
Primary	216	"Fault"	"Temperature 1 protection (input stage)"	Exceeded maximum limit
Primary	217	"Fault"	"Temperature 1 protection (input stage)"	Eceeded minimum limit."
Primary	218	"Fault"	"Temperature 2 protection (PFC/LLC)"	Exceeded maximum limit
Primary	219	"Fault"	"Temperature 2 protection (PFC/LLC)"	Eceeded minimum limit."
Primary	220	"Fault"	"Temperature 3 protection (PFC/LLC)"	Exceeded maximum limit
Primary	221	"Fault"	"Temperature 3 protection (PFC/LLC) exceeded minimum limit."	
Primary	222	"Fault"	"Temperature 4 protection (main transformer)"	Exceeded maximum limit
Primary	223	"Fault"	"Temperature 4 protection (main transformer)"	Eceeded minimum limit."
Primary	224	"Fault"	"Internal bias supply fault."	
Primary	230	"Fault"	"PFC output current peak protection."	
Primary	231	"Fault"	"PFC output current slow protection"	
Primary	232	"Fault"	"AC input: voltage is above maximum."	
Primary	234	"Fault"	"Firmware task execution error."	
Primary	225	"Internal fault"	"Global fault input signal detected."	
Primary	226	"Internal fault"	"Hardware does not match input voltage setting."	
Primary	227	"Internal fault"	"Primary capacitor board not detected."	
Primary	228	"Internal fault"	"Invalid node ID. Run unit discovery to recover."	
Primary	229	"Internal fault"	"Incorrect DSP type detected. Cycle-power to re-try."	
Primary	233	"Internal fault"	"Invalid constants loaded from EEPROM."	
Primary	261	"Internal fault"	"Controller is not in operational mode."	
Primary	262	"Internal fault"	"Missing controller node."	
Primary	263	"Internal fault"	"Cannot read fault information."	
IO board	399	"Fault"	"Transformer coupling circuits hardware fault."	
IO board	400	"Fault"	"Transformer coupling circuits not detected."	
IO board	401	"Fault"	"Remote inhibit was issued from remote interface."	

Source	Code	Type	Description	Possible cause
IO board	402	"Fault"	"Forced fault."	
IO board	393	"Internal fault"	"Global fault detected."	
IO board	394	"Internal fault"	"Internal board fault."	
IO board	395	"Internal fault"	"Invalid node ID. Run unit discovery to recover."	
IO board	396	"Internal fault"	"Incorrect DSP type detected. Cycle-power to re-try."	
IO board	397	"Internal fault"	"Invalid constants loaded from EEPROM."	
IO board	398	"Internal fault"	"Controller is not in operational mode."	
IO board	454	"Internal fault"	"Controller is not in operational mode."	
IO board	455	"Internal fault"	"Missing controller node."	
IO board	456	"Internal fault"	"Cannot read fault information."	
Controller	458	"Fault"	"Forced fault."	
Controller	459	"Fault"	"Internal board fault."	
Controller	460	"Fault"	"No waveform loaded. Load waveform before enabling arbitrary waveform mode."	
Controller	461	"Fault"	"Exceeded user RMS current limit."	
Controller	462	"Fault"	"Exceeded user active power limit."	
Controller	463	"Fault"	"Exceeded user apparent power limit."	
Controller	464	"Fault"	"Over power protection."	
Controller	470	"Fault"	"Sharing over-voltage protection."	
Controller	471	"Fault"	"Under frequency protection."	
Controller	472	"Fault"	"Over frequency protection."	
Controller	474	"Fault"	"Exceeded line to neutral common voltage."	
Controller	475	"Fault"	"Exceeded line to line common voltage."	
Controller	476	"Fault"	"Output current RMS exceeded limit."	
Controller	478	"Fault"	"Global fault input signal detected."	
Controller	481	"Fault"	"Output current peak protection."	
Controller	485	"Fault"	"Output power overload. RMS power exceeded limit."	
Controller	486	"Fault"	"Controller missed heartbeats from master front panel."	
Controller	487	"Fault"	"Output over-voltage protection."	
Controller	489	"Fault"	"DC current too high."	
Controller	490	"Fault"	"Remote voltage sensing fault."	
Controller	491	"Fault"	"Too high voltage present to enable relay."	Error sensing voltage. Could be caused by contactor bounce
Controller	492	"Fault"	"Remote Sensing Fault" RTC A, B or C	
Controller	493	"Fault"	"CSC loop has saturated"	
Controller	494	"Fault"	"Output current overload. RMS current exceeded limit."	
Controller	498	"Fault"	"Exceeded under RMS voltage protection level."	

Source	Code	Type	Description	Possible cause
Controller	499	"Fault"	"Exceeded over RMS voltage protection level."	
Controller	500	"Fault"	"Constant power over-voltage."	
Controller	502	"Fault"	"Emergency shutdown."	
Controller	503	"Fault"	"Power module not connected."	
Controller	504	"Fault"	"Master disabled."	
Controller	505	"Fault"	"Two masters detected or auxiliary unit fault/emergency shutdown."	
Controller	506	"Fault"	"Power module shutdown."	
Controller	507	"Fault"	"Power module coupling mismatch."	
Controller	508	"Fault"	"Power module form mismatch."	
Controller	509	"Fault"	"Power module not detected."	
Controller	510	"Fault"	"Power module communication fault."	
Controller	511	"Fault"	"Power module local fault."	
Controller	465	"Internal fault"	"Internal McBSP communication CRC error."	
Controller	466	"Internal fault"	"Internal sync error in CPU1."	
Controller	467	"Internal fault"	"Internal sync error in CPU2."	
Controller	468	"Internal fault"	"CPU1 invalid fault."	
Controller	469	"Internal fault"	"CPU2 invalid fault."	
Controller	477	"Internal fault"	"Firmware mismatch between CPUs."	
Controller	479	"Internal fault"	"Bootloader firmware mismatch between CPUs."	
Controller	480	"Internal fault"	"Port expander unreachable."	
Controller	482	"Internal fault"	"CLA task timeout."	
Controller	483	"Internal fault"	"Invalid node ID. Run unit discovery to recover."	
Controller	484	"Internal fault"	"Incorrect DSP type detected. Cycle-power to re-try."	
Controller	488	"Internal fault"	"Invalid constants loaded from EEPROM."	
Controller	519	"Internal fault"	"Controller is not in operational node."	
Controller	520	"Internal fault"	"Missing controller node."	
Controller	521	"Internal fault"	"Cannot read fault information."	
Power controller	1000	"Internal fault"	"Inverter DC bus over voltage protection."	
Power controller	1001	"Internal fault"	"Inverter DC bus under voltage protection."	
Power controller	1002	"Internal fault"	"Inverter over temperature protection."	
Power controller	1003	"Internal fault"	"Inverter hardware fault."	
Power controller	1004	"Internal fault"	"Primary pre-charge fault."	
Power controller	1005	"Internal fault"	"Inverter over current protection."	
Power controller	1006	"Internal fault"	"Inverter NTC fault."	

Source	Code	Type	Description	Possible cause
Power controller	1007	"Internal fault"	"Inverter EEPROM fault."	
Power controller	1011	"Internal fault"	"Inverter PWM sync fault."	
Power controller	1015	"Internal fault"	"Communication fault."	
Power controller	1024	"Internal fault"	"Inverter fast RMS over current protection."	
Power controller	1025	"Internal fault"	"Inverter slow RMS over current protection."	
Power controller	1031	"Internal fault"	"Inverter communication fault."	
Power controller	1032	"Internal fault"	"Primary DC bus over voltage protection."	
Power controller	1033	"Internal fault"	"Primary DC bus under voltage protection."	
Power controller	1034	"Internal fault"	"Primary over temperature protection."	
Power controller	1035	"Internal fault"	"Primary hardware fault."	
Power controller	1036	"Internal fault"	"Primary pre-charge fault."	
Power controller	1037	"Internal fault"	"Primary over current protection."	
Power controller	1038	"Internal fault"	"Primary NTC fault."	
Power controller	1039	"Internal fault"	"Primary EEPROM fault."	
Power controller	1041	"Internal fault"	"Primary AC not detected."	
Power controller	1043	"Internal fault"	"Primary PWM sync fault."	
Power controller	1046	"Internal fault"	"Communication fault."	
Power controller	1048	"Internal fault"	"Primary AC over voltage protection."	
Power controller	1049	"Internal fault"	"Primary AC under voltage protection."	
Power controller	1050	"Internal fault"	"Primary AC frequency too high."	
Power controller	1051	"Internal fault"	"Primary AC frequency too low."	
Power controller	1052	"Internal fault"	"Primary AC zero crossing fault."	
Power controller	1056	"Internal fault"	"Primary fast RMS over current protection."	
Power controller	1057	"Internal fault"	"Primary slow RMS over current protection."	
Power controller	1063	"Internal fault"	"Primary communication fault."	
Power module	1065	"Fault"	"Inverter DC bus over voltage protection."	
Power module	1066	"Fault"	"Inverter DC bus under voltage protection."	
Power module	1067	"Fault"	"Inverter over temperature protection."	

Source	Code	Type	Description	Possible cause
Power module	1068	"Fault"	"Inverter hardware fault."	
Power module	1070	"Fault"	"Inverter over current protection."	
Power module	1071	"Fault"	"Inverter NTC fault."	
Power module	1072	"Fault"	"Inverter EEPROM fault."	
Power module	1076	"Fault"	"Inverter PWM sync fault."	
Power module	1089	"Fault"	"Inverter fast RMS over current protection."	
Power module	1090	"Fault"	"Inverter slow RMS over current protection."	
Power module	1096	"Fault"	"Inverter communication fault."	
Power module	1097	"Fault"	"Primary DC bus over voltage protection."	
Power module	1098	"Fault"	"Primary DC bus under voltage protection."	
Power module	1099	"Fault"	"Primary over temperature protection."	
Power module	1100	"Fault"	"Primary hardware fault."	
Power module	1101	"Fault"	"Primary pre-charge fault."	
Power module	1102	"Fault"	"Primary over current protection."	
Power module	1103	"Fault"	"Primary NTC fault."	
Power module	1104	"Fault"	"Primary EEPROM fault."	
Power module	1106	"Fault"	"Primary AC not detected."	
Power module	1108	"Fault"	"Primary PWM sync fault."	
Power module	1113	"Fault"	"Primary AC over voltage protection."	
Power module	1114	"Fault"	"Primary AC under voltage protection."	
Power module	1115	"Fault"	"Primary AC frequency too high."	
Power module	1116	"Fault"	"Primary AC frequency too low."	
Power module	1117	"Fault"	"Primary AC zero crossing fault."	
Power module	1121	"Fault"	"Primary fast RMS over current protection."	
Power module	1122	"Fault"	"Primary slow RMS over current protection."	
Power module	1128	"Fault"	"Primary communication fault."	

Table 12-1: Warnings and Error Messages Listing

13 Service and Maintenance

13.1 Warnings



WARNING

THIS EQUIPMENT CONTAINS HIGH ENERGY, LOW IMPEDANCE CIRCUITS! LETHAL POTENTIALS ARE CONTAINED WITHIN THIS UNIT.

CARE MUST BE EXERCISED WHEN SERVICING THIS EQUIPMENT IN ORDER TO PREVENT SERIOUS SERVICE PERSONNEL INJURY OR EQUIPMENT DAMAGE.

OBSERVE THE FOLLOWING WHEN SERVICE OR MAINTENANCE ARE REQUIRED:

- 1. REMOVE ALL JEWELRY FROM ARMS AND NECK WHEN SERVICING THIS EQUIPMENT. THIS PREVENTS THE POSSIBILITY OF SHORTING THROUGH THE JEWELRY AND CAUSING BURNS TO SERVICE PERSONNEL.**
- 2. WEAR SAFETY GLASSES WHEN SERVICING THIS EQUIPMENT TO PREVENT EYE INJURY DUE TO FLYING PARTICLES CAUSED BY ACCIDENTAL SHORT CIRCUIT CONDITIONS.**
- 3. DO NOT REMOVE ANY PANEL OR COVER WITHOUT FIRST REMOVING THE INPUT SERVICE BY OPENING ALL CIRCUIT BREAKERS.**
- 4. DO NOT REMOVE ANY PANEL OR COVER WITHOUT FIRST WAITING 20 MINUTES FOR ALL INTERNAL CHARGES TO DISSIPATE TO A SAFE LEVEL.**
- 5. SERVICE OTHER THAN EXTERNAL CLEANING SHOULD BE REFERRED TO PERSONNEL AUTHORIZED BY THE FACTORY TO SERVICE THIS EQUIPMENT.**



AVERTISSEMENT

CET ÉQUIPEMENT CONTIENT DES CIRCUITS À HAUTE ÉNERGIE ET À BASSE IMPÉDANCE ! LES POTENTIELS MORTELS SONT CONTENUS DANS CETTE UNITÉ.

IL FAUT FAIRE ATTENTION LORS DE L'ENTRETIEN DE CET ÉQUIPEMENT AFIN D'ÉVITER DES BLESSURES GRAVES DU PERSONNEL D'ENTRETIEN OU DES DOMMAGES À L'ÉQUIPEMENT.

OBSERVEZ CE QUI SUIT LORSQUE L'ENTRETIEN OU LA MAINTENANCE SONT NÉCESSAIRES :

- 1. RETIREZ TOUS LES BIJOUX DES BRAS ET DU COU LORS DE L'ENTRETIEN DE CET ÉQUIPEMENT. CELA EMPÊCHE LA POSSIBILITÉ DE COURT-CIRCUIT À TRAVERS LES BIJOUX ET DE CAUSER DES BRÛLURES AU PERSONNEL D'ENTRETIEN.**
- 2. PORTEZ DES LUNETTES DE SÉCURITÉ LORS DE L'ENTRETIEN DE CET ÉQUIPEMENT AFIN D'ÉVITER LES BLESSURES OCULAIRES DUES AUX PARTICULES VOLANTES CAUSÉES PAR DES CONDITIONS DE COURT-CIRCUIT ACCIDENTELS.**
- 3. NE RETIREZ AUCUN PANNEAU OU COUVERCLE SANS D'ABORD RETIRER LE SERVICE D'ENTRÉE EN OUVRANT TOUS LES DISJONCTEURS.**
- 4. NE RETIREZ AUCUN PANNEAU OU COUVERCLE SANS AVOIR D'ABORD ATTENDU 20 MINUTES QUE TOUTES LES CHARGES INTERNES SE DISSIPENT À UN NIVEAU SÛR.**

5. TOUTE RÉPARATION AUTRE QUE LE NETTOYAGE EXTERNE DOIT ÊTRE RÉFÉRÉE AU PERSONNEL AUTORISÉ PAR L'USINE POUR RÉPARER CET ÉQUIPEMENT.

13.2 Authorized Service Centers

There are **NO** end-user serviceable parts in this product. In case of a problem or malfunction, **DO NOT ATTEMPT TO REPAIR!** Instead, contact one of Pacific Power Source's authorized service centers or your local Pacific Power Source distributor. For a list of authorized service centers, refer to section 1, "Contact Information".

14 ModBus TCP Server / Slave Interface

14.1 ModBus TCP Interface

The ModBus TCP Server/Slave Interface provides a means to communicate with industrial bus protocols over Ethernet LAN network. This is a register-based interface, so no SCPI syntax programming commands apply. Instead of sending commands, the user can write or read values to or from specific register addresses to change various settings and read from other registers such as measurements or settings.

Gateway devices are available from third parties to connect to other bus protocols, e.g.:

<https://www.anybus.com/products/gateway-index?Network-Interface-1=Modbus-TCP-Client/Master>

These gateways perform an intelligent protocol translation that allows devices and control systems using different protocols to communicate with each other seamlessly.

To use this interface, the user needs to reference the register addresses provided in the next section.

14.2 Modbus TCP Register Tables

The following tables apply to ADF, AFX, AZX, LMX and LSX Series power sources models. Some functions may not be supported on specific model series depending on supported modes of operation and feature sets.

Note: The information contained in the table below is available for download in MS Excel file [modbustcp-registers.xlsx](#) at the following link under ‘documentation’:

https://github.com/PPST-Inc/ModbusTCP_Examples

Modbus App

	Modbus address (dec)	Modbus address (hex)	Read coils	Read holding registers	Read input registers (0x06)	Write single coil (0x05)	Write single register (0x06)	Write multiple registers (0x10)	Description	Access	Data type	Data length in bytes	Number of registers	Data	Example
Modbus Interface	0	0000													
	1	0001			x				Modbus Ver	R	uint(16)	2	1		
	2	0002			x				Modbus Info	R	uint(16)	2	1		
Measurements	1000	03E8			x				Frequency	R	float	4	2	FP IEEE754	60
	1002	03EA			x				Output A frequency	R	float	4	2	FP IEEE754	
	1004	03EC			x				Output B frequency	R	float	4	2	FP IEEE754	

Modbus App

Modbus address (dec)	Modbus address (hex)	Read coils	Read holding registers	Read input registers (0x06)	Write single coil (0x05)	Write single register (0x06)	Write multiple registers (0x10)	Description	Access	Data type	Data length in bytes	Number of registers	Data	Example
1006	03EE			x				Output C frequency	R	float	4	2	FP IEEEE754	
1008	03F0			x				Voltage line to line ACDC	R	float	4	2	FP IEEEE754	
1010	03F2			x				Output A voltage line to line ACDC	R	float	4	2	FP IEEEE754	
1012	03F4			x				Output B voltage line to line ACDC	R	float	4	2	FP IEEEE754	
1014	03F6			x				Output C voltage line to line ACDC	R	float	4	2	FP IEEEE754	
1016	03F8			x				Voltage line to line AC	R	float	4	2	FP IEEEE754	
1018	03FA			x				Output A voltage line to line AC	R	float	4	2	FP IEEEE754	
1020	03FC			x				Output B voltage line to line AC	R	float	4	2	FP IEEEE754	
1022	03FE			x				Output C voltage line to line AC	R	float	4	2	FP IEEEE754	
1024	0400			x				Voltage line to line DC	R	float	4	2	FP IEEEE754	
1026	0402			x				Output A voltage line to line DC	R	float	4	2	FP IEEEE754	
1028	0404			x				Output B voltage line to line DC	R	float	4	2	FP IEEEE754	
1030	0406			x				Output C voltage line to line DC	R	float	4	2	FP IEEEE754	
1032	0408			x				Voltage ACDC	R	float	4	2	FP IEEEE754	
1034	040A			x				Output A voltage ACDC	R	float	4	2	FP IEEEE754	
1036	040C			x				Output B voltage ACDC	R	float	4	2	FP IEEEE754	
1038	040E			x				Output C voltage ACDC	R	float	4	2	FP IEEEE754	
1040	0410			x				Voltage AC	R	float	4	2	FP IEEEE754	

Modbus App

Modbus address (dec)	Modbus address (hex)	Read coils	Read holding registers	Read input registers (0x06)	Write single coil (0x05)	Write single register (0x06)	Write multiple registers (0x10)	Description	Access	Data type	Data length in bytes	Number of registers	Data	Example
1042	0412			x				Output A voltage AC	R	float	4	2	FP IEEE754	
1044	0414			x				Output B voltage AC	R	float	4	2	FP IEEE754	
1046	0416			x				Output C voltage AC	R	float	4	2	FP IEEE754	
1048	0418			x				Voltage DC	R	float	4	2	FP IEEE754	
1050	041A			x				Output A voltage DC	R	float	4	2	FP IEEE754	
1052	041C			x				Output B voltage DC	R	float	4	2	FP IEEE754	
1054	041E			x				Output C voltage DC	R	float	4	2	FP IEEE754	
1056	0420			x				Current ACDC	R	float	4	2	FP IEEE754	
1058	0422			x				Output A current ACDC	R	float	4	2	FP IEEE754	
1060	0424			x				Output B current ACDC	R	float	4	2	FP IEEE754	
1062	0426			x				Output C current ACDC	R	float	4	2	FP IEEE754	
1064	0428			x				Current DC	R	float	4	2	FP IEEE754	
1066	042A			x				Output A current DC	R	float	4	2	FP IEEE754	
1068	042C			x				Output B current DC	R	float	4	2	FP IEEE754	
1070	042E			x				Output C current DC	R	float	4	2	FP IEEE754	
1072	0430			x				Active power	R	float	4	2	FP IEEE754	
1074	0432			x				Output A active power	R	float	4	2	FP IEEE754	
1076	0434			x				Output B active power	R	float	4	2	FP IEEE754	
1078	0436			x				Output C active power	R	float	4	2	FP IEEE754	
1080	0438			x				Apparent power	R	float	4	2	FP IEEE754	
1082	043A			x				Output A apparent power	R	float	4	2	FP IEEE754	
1084	043C			x				Output B apparent power	R	float	4	2	FP IEEE754	

Modbus App

Modbus address (dec)	Modbus address (hex)	Read coils	Read holding registers	Read input registers (0x06)	Write single coil (0x05)	Write single register (0x06)	Write multiple registers (0x10)	Description	Access	Data type	Data length in bytes	Number of registers	Data	Example
1086	043E			x				Output C apparent power	R	float	4	2	FP IEEE754	
1088	0440			x				Peak current	R	float	4	2	FP IEEE754	
1090	0442			x				Output A peak current	R	float	4	2	FP IEEE754	
1092	0444			x				Output B peak current	R	float	4	2	FP IEEE754	
1094	0446			x				Output C peak current	R	float	4	2	FP IEEE754	
1096	0448			x				Power factor	R	float	4	2	FP IEEE754	
1098	044A			x				Output A power factor	R	float	4	2	FP IEEE754	
1100	044C			x				Output B power factor	R	float	4	2	FP IEEE754	
1102	044E			x				Output C power factor	R	float	4	2	FP IEEE754	
1104	0450			x				Crest factor	R	float	4	2	FP IEEE754	
1106	0452			x				Output A crest factor	R	float	4	2	FP IEEE754	
1108	0454			x				Output B crest factor	R	float	4	2	FP IEEE754	
1110	0456			x				Output C crest factor	R	float	4	2	FP IEEE754	
1112	0458			x				Peak current recorded	R	float	4	2	FP IEEE754	
1114	045A			x				Output A peak current recorded	R	float	4	2	FP IEEE754	
1116	045C			x				Output B peak current recorded	R	float	4	2	FP IEEE754	
1118	045E			x				Output C peak current recorded	R	float	4	2	FP IEEE754	
1120	0460			x				Voltage thd	R	float	4	2	FP IEEE754	
1122	0462			x				Output A voltage thd	R	float	4	2	FP IEEE754	
1124	0464			x				Output B voltage thd	R	float	4	2	FP IEEE754	
1126	0466			x				Output C voltage thd	R	float	4	2	FP IEEE754	
1128	0468			x				Current thd	R	float	4	2	FP IEEE754	

Modbus App

Modbus address (dec)	Modbus address (hex)	Read coils	Read holding registers	Read input registers (0x06)	Write single coil (0x05)	Write single register (0x06)	Write multiple registers (0x10)	Description	Access	Data type	Data length in bytes	Number of registers	Data	Example
1130	046A			x				Output A current thd	R	float	4	2	FP IEEE754	
1132	046C			x				Output B current thd	R	float	4	2	FP IEEE754	
1134	046E			x				Output C current thd	R	float	4	2	FP IEEE754	
1136	0470			x				Power factor angle	R	float	4	2	FP IEEE754	
1138	0472			x				Output A power factor angle	R	float	4	2	FP IEEE754	
1140	0474			x				Output B power factor angle	R	float	4	2	FP IEEE754	
1142	0476			x				Output C power factor angle	R	float	4	2	FP IEEE754	
1144	0478			x				Displacement factor	R	float	4	2	FP IEEE754	
1146	047A			x				Output A displacement factor	R	float	4	2	FP IEEE754	
1148	047C			x				Output B displacement factor	R	float	4	2	FP IEEE754	
1150	047E			x				Output C displacement factor	R	float	4	2	FP IEEE754	
1152	0480			x				Distortion factor	R	float	4	2	FP IEEE754	
1154	0482			x				Output A distortion factor	R	float	4	2	FP IEEE754	
1156	0484			x				Output B distortion factor	R	float	4	2	FP IEEE754	
1158	0486			x				Output C distortion factor	R	float	4	2	FP IEEE754	
1160	0488			x				Kilowatt hour	R	float	4	2	FP IEEE754	
1162	048A			x				Output A kilowatt hour	R	float	4	2	FP IEEE754	
1164	048C			x				Output B kilowatt hour	R	float	4	2	FP IEEE754	

Modbus App

Modbus address (dec)	Modbus address (hex)	Read coils	Read holding registers	Read input registers (0x06)	Write single coil (0x05)	Write single register (0x06)	Write multiple registers (0x10)	Description	Access	Data type	Data length in bytes	Number of registers	Data	Example
1166	048E			x				Output C kilowatt hour	R	float	4	2	FP IEEE754	
1168	0490			x				Kilowatt hour elapsed time	R	float	4	2	FP IEEE754	
1170	0492			x				Output A kilowatt hour elapsed time	R	float	4	2	FP IEEE754	
1172	0494			x				Output B kilowatt hour elapsed time	R	float	4	2	FP IEEE754	
1174	0496			x				Output C kilowatt hour elapsed time	R	float	4	2	FP IEEE754	
2800	0AF0	x			x			Reset KWH	RW	bool			Coils : Kreset	ON=reset , self clear
2801	0AF1	x			x			Enable KWH	RW	bool			Coils : Kwhenable	ON=enable, OFF=disable

Setpoints Program	3000	0BB8						Program frequency	RW	float	4	2	FP IEEE754	
	3002	0BBA						Program frequency A	RW	float	4	2	FP IEEE754	
	3004	0BBC						Program frequency B	RW	float	4	2	FP IEEE754	
	3006	0BBE						Program frequency C	RW	float	4	2	FP IEEE754	
	3008	0BC0						Program voltage AC	RW	float	4	2	FP IEEE754	Value=V ALUE if all set, Value=0 if else
	3010	0BC2						Program voltage AC output A	RW	float	4	2	FP IEEE754	
	3012	0BC4						Program voltage AC output B	RW	float	4	2	FP IEEE754	
	3014	0BC6						Program voltage AC output C	RW	float	4	2	FP IEEE754	

Modbus App

Modbus address (dec)	Modbus address (hex)	Read coils	Read holding registers	Read input registers (0x06)	Write single coil (0x05)	Write single register (0x06)	Write multiple registers (0x10)	Description	Access	Data type	Data length in bytes	Number of registers	Data	Example
3016	0BC8							Program voltage DC	RW	float	4	2	FP IEEEE754	Value=V ALUE if all set, Value=0 if else
3018	0BCA							Program voltage DC output A	RW	float	4	2	FP IEEEE754	
3020	0BCC							Program voltage DC output B	RW	float	4	2	FP IEEEE754	
3022	0BCE							Program voltage DC output C	RW	float	4	2	FP IEEEE754	
3024	0BD0							Power limit	RW	float	4	2	FP IEEEE754	Value=V ALUE if all set, Value=0 if else
3026	0BD2							Power limit output A	RW	float	4	2	FP IEEEE754	
3028	0BD4							Power limit output B	RW	float	4	2	FP IEEEE754	
3030	0BD6							Power limit output C	RW	float	4	2	FP IEEEE754	
3032	0BD8							Current limit ABC	RW	float	4	2	FP IEEEE754	Value=V ALUE if all set, Value=0 if else
3034	0BDA							Current limit output A	RW	float	4	2	FP IEEEE754	
3036	0BDC							Current limit output B	RW	float	4	2	FP IEEEE754	
3038	0BDE							Current limit output C	RW	float	4	2	FP IEEEE754	
3040	0BE0							KVA Limit	RW	float	4	2	FP IEEEE754	Value=V ALUE if all set, Value=0 if else
3042	0BE2							KVA Limit output A	RW	float	4	2	FP IEEEE754	
3044	0BE4							KVA Limit output B	RW	float	4	2	FP IEEEE754	

Modbus App

Modbus address (dec)	Modbus address (hex)	Read coils	Read holding registers	Read input registers (0x06)	Write single coil (0x05)	Write single register (0x06)	Write multiple registers (0x10)	Description	Access	Data type	Data length in bytes	Number of registers	Data	Example
3046	0BE6							KVA Limit output C	RW	float	4	2	FP IEEE754	
3048	0BE8							Phase offset output B	RW	float	4	2	FP IEEE754	
3050	0BEA							Phase offset output C	RW	float	4	2	FP IEEE754	
4000	0FA0	x			x			Enable output	RW	bool			Coils: Output	ON=enable, OFF=disable
4001	0FA1	x			x			Enable output A	RW	bool			Coils: Output	ON=enable, OFF=disable
4002	0FA2	x			x			Enable output B	RW	bool			Coils: Output	ON=enable, OFF=disable
4003	0FA3	x			x			Enable output C	RW	bool			Coils: Output	ON=enable, OFF=disable

Protection

5000	1388	x			x			RMS Current protection	RW	bool				
5001	1389	x			x			Output A RMS Current protection	RW	bool				
5002	138A	x			x			Output B RMS Current protection	RW	bool				
5003	138B	x			x			Output C RMS Current protection	RW	bool				
5004	138C	x			x			RMS Power protection	RW	bool				
5005	138D	x			x			Output A RMS Power protection	RW	bool				
5006	138E	x			x			Output B RMS Power protection	RW	bool				

Modbus App

Modbus address (dec)	Modbus address (hex)	Read coils	Read holding registers	Read input registers (0x06)	Write single coil (0x05)	Write single register (0x06)	Write multiple registers (0x10)	Description	Access	Data type	Data length in bytes	Number of registers	Data	Example
5007	138F	x			x			Output C RMS Power protection	RW	bool				
5008	1390	x			x			Peak current protection	RW	bool				
5009	1391	x			x			Output A Peak current protection	RW	bool				
5010	1392	x			x			Output B Peak current protection	RW	bool				
5011	1393	x			x			Output C Peak current protection	RW	bool				
5012	1394	x			x			Peak voltage protection	RW	bool				
5013	1395	x			x			Output A Peak voltage protection	RW	bool				
5014	1396	x			x			Output B Peak voltage protection	RW	bool				
5015	1397	x			x			Output C Peak voltage protection	RW	bool				
5024	13A0							Current level	RW	float	4	2	FP IEEE754	
5026	13A2							Output A Current level	RW	float	4	2	FP IEEE754	
5028	13A4							Output B Current level	RW	float	4	2	FP IEEE754	
5030	13A6							Output C Current level	RW	float	4	2	FP IEEE754	
5032	13A8							Power level	RW	float	4	2	FP IEEE754	
5034	13AA							Output A Power level	RW	float	4	2	FP IEEE754	
5036	13AC							Output B Power level	RW	float	4	2	FP IEEE754	
5038	13AE							Output C Power level	RW	float	4	2	FP IEEE754	
5040	13B0							KVA Level	RW	float	4	2	FP IEEE754	
5042	13B2							Output A KVA Level	RW	float	4	2	FP IEEE754	
5044	13B4							Output B KVA Level	RW	float	4	2	FP IEEE754	

Modbus App

Modbus address (dec)	Modbus address (hex)	Read coils	Read holding registers	Read input registers (0x06)	Write single coil (0x05)	Write single register (0x06)	Write multiple registers (0x10)	Description	Access	Data type	Data length in bytes	Number of registers	Data	Example
5046	13B6							Output C KVA Level	RW	float	4	2	FP IEEE754	
5048	13B8							Trip time	RW	float	4	2	FP IEEE754	minimum step of 0.1 seconds
5050	13BA							Output A Trip time	RW	float	4	2	FP IEEE754	
5052	13BC							Output B Trip time	RW	float	4	2	FP IEEE754	
5054	13BE							Output C Trip time	RW	float	4	2	FP IEEE754	
5056	13C0							Peak current limit	RW	float	4	2	FP IEEE754	
5058	13C2							Output A Peak current limit	RW	float	4	2	FP IEEE754	
5060	13C4							Output B Peak current limit	RW	float	4	2	FP IEEE754	
5062	13C6							Output C Peak current limit	RW	float	4	2	FP IEEE754	
5064	13C8							Peak current protection level	RW	float	4	2	FP IEEE754	
5066	13CA							Output A Peak current protection level	RW	float	4	2	FP IEEE754	
5068	13CC							Output B Peak current protection level	RW	float	4	2	FP IEEE754	
5070	13CE							Output C Peak current protection level	RW	float	4	2	FP IEEE754	
5072	13D0							Peak voltage protection margin	RW	float	4	2	FP IEEE754	
5074	13D2							Output A Peak voltage protection margin	RW	float	4	2	FP IEEE754	

Modbus App

Modbus address (dec)	Modbus address (hex)	Read coils	Read holding registers	Read input registers (0x06)	Write single coil (0x05)	Write single register (0x06)	Write multiple registers (0x10)	Description	Access	Data type	Data length in bytes	Number of registers	Data	Example
5076	13D4							Output B Peak voltage protection margin	RW	float	4	2	FP IEEE754	
5078	13D6							Output C Peak voltage protection margin	RW	float	4	2	FP IEEE754	
5080	13D8							Peak voltage protection level	RW	float	4	2	FP IEEE754	
5082	13DA							Output A Peak voltage protection level	RW	float	4	2	FP IEEE754	
5084	13DC							Output B Peak voltage protection level	RW	float	4	2	FP IEEE754	
5086	13DE							Output C Peak voltage protection level	RW	float	4	2	FP IEEE754	
5088	13E0							Peak voltage protection mode	RW	uint(16)	2	1	unsngnd int 16b	0=MARGIN, 1=LEVEL, 2=MARGIN & LEVEL
5090	13E2							Output A Peak voltage protection mode	RW	uint(16)	2	1	unsngnd int 16b	
5092	13E4							Output B Peak voltage protection mode	RW	uint(16)	2	1	unsngnd int 16b	
5094	13E6							Output C Peak voltage protection mode	RW	uint(16)	2	1	unsngnd int 16b	

Configuration	6000	1770						Ramp time	RW	float	4	2	FP IEEE754	0.222 Seconds
---------------	------	------	--	--	--	--	--	-----------	----	-------	---	---	------------	---------------

Modbus App

	Modbus address (dec)	Modbus address (hex)	Read coils	Read holding registers	Read input registers (0x06)	Write single coil (0x05)	Write single register (0x06)	Write multiple registers (0x10)	Description	Access	Data type	Data length in bytes	Number of registers	Data	Example
Slew	6002	1772							Output A Ramp time	RW	float	4	2	FP IEEE754	
	6004	1774							Output B Ramp time	RW	float	4	2	FP IEEE754	
	6006	1776							Output C Ramp time	RW	float	4	2	FP IEEE754	
	6008	1778							Voltage AC	RW	float	4	2	FP IEEE754	
	6010	177A							Output A Voltage AC	RW	float	4	2	FP IEEE754	
	6012	177C							Output B Voltage AC	RW	float	4	2	FP IEEE754	
	6014	177E							Output C Voltage AC	RW	float	4	2	FP IEEE754	
	6016	1780							Frequency	RW	float	4	2	FP IEEE754	
	6018	1782							Output A Frequency	RW	float	4	2	FP IEEE754	
	6020	1784							Output B Frequency	RW	float	4	2	FP IEEE754	
	6022	1786							Output C Frequency	RW	float	4	2	FP IEEE754	
	6024	1788							Voltage DC	RW	float	4	2	FP IEEE754	
	6026	178A							Output A Voltage DC	RW	float	4	2	FP IEEE754	
	6028	178C							Output B Voltage DC	RW	float	4	2	FP IEEE754	
	6030	178E							Output C Voltage DC	RW	float	4	2	FP IEEE754	
	6032	1790							Phase	RW	float	4	2	FP IEEE754	
	6034	1792							Output A Phase	RW	float	4	2	FP IEEE754	
	6036	1794							Output B Phase	RW	float	4	2	FP IEEE754	
	6038	1796							Output C Phase	RW	float	4	2	FP IEEE754	
	6040	1798				x			Slew rate control	RW	bool				
6041	1799				x			Output A Slew rate control	RW	bool					
6042	179A				x			Output B Slew rate control	RW	bool					

Modbus App

Modbus address (dec)	Modbus address (hex)	Read coils	Read holding registers	Read input registers (0x06)	Write single coil (0x05)	Write single register (0x06)	Write multiple registers (0x10)	Description	Access	Data type	Data length in bytes	Number of registers	Data	Example
6043	179B				x			Output C Slew rate control	RW	bool				

Configuration	8000	1F40						Configuration form	RW	uint(16)	2	1	unsgnd int 16b	1=SINGLE, 2=SPLIT, 3=THREE
Unit	8001	1F41						Configuration voltage range	RW	uint(16)	2	1	unsgnd int 16b	0=LOW, 1=HIGH
Settings	8002	1F42						Configuration mode	RW	uint(16)	2	1	unsgnd int 16b	0=AC, 1=DC, 2=AC-DC
	8003	1F43						Phase rotation	RW	uint(16)	2	1	unsgnd int 16b	0=NEGATIVE, 1=POSITIVE
	8004	1F44						Output impedance mode	RW	uint(16)	2	1	unsgnd int 16b	0=REAL TIME, 1=RMS
	8005	1F45						Output A impedance mode	RW	uint(16)	2	1	unsgnd int 16b	
	8006	1F46						Output B impedance mode	RW	uint(16)	2	1	unsgnd int 16b	
	8007	1F47						Output C impedance mode	RW	uint(16)	2	1	unsgnd int 16b	
	8016	1F50						Update phase	RW	float	4	2	FP IEEE754	
	8018	1F52						Output A update phase	RW	float	4	2	FP IEEE754	
	8020	1F54						Output B update phase	RW	float	4	2	FP IEEE754	
	8022	1F56						Output C update phase	RW	float	4	2	FP IEEE754	
	8024	1F58						Output phase disable	RW	float	4	2	FP IEEE754	
	8026	1F5A						Output A phase disable	RW	float	4	2	FP IEEE754	
	8028	1F5C						Output B phase disable	RW	float	4	2	FP IEEE754	

Modbus App

Modbus address (dec)	Modbus address (hex)	Read coils	Read holding registers	Read input registers (0x06)	Write single coil (0x05)	Write single register (0x06)	Write multiple registers (0x10)	Description	Access	Data type	Data length in bytes	Number of registers	Data	Example
8030	1F5E							Output C phase disable	RW	float	4	2	FP IEEE754	
8032	1F60							Max CSC gain	RW	float	4	2	FP IEEE754	
8034	1F62							Output A max CSC gain	RW	float	4	2	FP IEEE754	
8036	1F64							Output B max CSC gain	RW	float	4	2	FP IEEE754	
8038	1F66							Output C max CSC gain	RW	float	4	2	FP IEEE754	
8048	1F70	x			x			Continuous self calibration	RW	bool				
8049	1F71	x			x			Output A continuous self calibration	RW	bool				
8050	1F72	x			x			Output B continuous self calibration	RW	bool				
8051	1F73	x			x			Output C continuous self calibration	RW	bool				
8052	1F74	x			x			Fault on saturation	RW	bool				
8053	1F75	x			x			Output A fault on saturation	RW	bool				
8054	1F76	x			x			Output B fault on saturation	RW	bool				
8055	1F77	x			x			Output C fault on saturation	RW	bool				

SCPI	6400 0	FA00						SCPI Write/query	RW	char	246	123	ASCII	MEASure : VOLTage : DC:NC#?
	6425 6	FB00						SCPI Command last answer			1024	512	ASCII	0.000,0 .000 0.000,0 .000

Modbus App

Modbus address (dec)	Modbus address (hex)	Read coils	Read holding registers	Read input registers (0x06)	Write single coil (0x05)	Write single register (0x06)	Write multiple registers (0x10)	Description	Access	Data type	Data length in bytes	Number of registers	Data	Example
64769	FD01	x			x			SCPI Char 16 endianess	RW	bool			Coils : Endianess	OFF= little, ON= Inverted
64770	FD02	x			x			SCPI Response next page	RW	bool			Coils : Next Page	ON=next, self clear

14.3 ModBus Control Example using Python

For those not familiar with using the ModBus TCP protocols, the example code shown here using Python may be of assistance in getting started.

Note: The example code named “modbustcp-example-1.py” referenced below is available for download at the following link in the ‘python’ directory:

https://github.com/PPST-Inc/ModbusTCP_Examples

This example code performs the following tasks in the order shown below.

```
> python.exe modbustcp-example-1.py
Enter the IP address of the unit: 192.168.107.183
Connecting
Setting voltage AC to 0 Vrms
Setting frequency to 50 Hz
Turning output on...
Setting voltage AC to 30 Vrms
Reading RMS voltage measurement
Voltage RMS measurement: 29.93 Vrms
Reading RMS current measurement
Current RMS measurement: 2.74 Arms
Turning output off
Disconnecting
Done
```

The dependencies and requirements to run the sample code are shown in the program comments and are:

```
# PPST ModbusTCP python example 1
# Version: 1.0.0
# Date: 11/07/2022
# Dependences:
# - pip install pymodbus
# - pip install pyModbusTCP
# Last tested with:
# - Python 3.10.5
# - pymodbus 3.0.2
# - pyModbusTCP 0.2.0
```

More advanced samples can be found using the link referenced above.

15 CAN / CAN-FD Interface

15.1 CAN / CAN-FD Interface Option

The “FD” in CAN-FD stands for “Flexible Data” rates. The Classical CAN offers 11-bit (standard) and 29-bit (extended) data rates, whereas CAN FD as the name suggests, offers flexible data rates, ranging from 0-64 bytes per frame. BOSCH had developed both these technologies to support the ever-growing need for data and technology in the automotive industry.

The basic differences are summarized in the table below for reference.

	Classic CAN	CAN FD
1	Initial Controlled Area Network bus (CAN bus). A communication protocol for automotive applications.	Launched as an advanced version of Classical CAN bus. Offers upgrades to almost every feature of CAN.
2	Fixed DCL rate of 8 bytes	Supports a flexible message payload, ranging from 0, 8, 12, 16, 20, 24, 32, 48, 64 bytes
3	Ideal choice for applications where the number of ECU's is more than and the bandwidth utilization is less.	Flexible signal transmission provides better functionality for advanced data and bandwidth applications.
4	Offers maximum data rate of 1 Mbps	Offers 2, 5 and 8 Mbps data rates.
5	No upward compatibility.	Downward compatible with Classic CAN.

15.2 USB to CAN Bus Adaptor Required

On Pacific Power Source products, CAN / CAN-FD is implemented using a USB to CAN / CAN-FD adaptor available from Peak Systems, Inc.

<https://www.peak-system.com/PCAN-USB-FD.365.0.html?&L=1>

This interface support was added with Firmware version 4.2.0 and higher. Users with older firmware must get a firmware update before being able to use this interface.

The USB to CAN-FD external adaptor is connected to the power source using one of the two front panel USB type A connectors.



Note: Do not connect to the power source USB Type B interface port on the real panel.

15.2.1 Key features and Specifications are:

- Adapter for High-speed USB 2.0 (compatible to USB 1.1 and USB 3.0)
- Complies with CAN specifications 2.0 A/B and FD 1.0
- CAN FD bit rates for the data field (64 bytes max.) from 40 kbit/s up to 12 Mbit/s
- CAN bit rates from 40 kbit/s up to 1 Mbit/s
- Time stamp resolution 1 μ s
- CAN bus connection via D-Sub, 9-pin
- (in accordance with CiA® 102)
- FPGA implementation of the CAN FD controller
- NXP TJA1044GT CAN transceiver
- Galvanic isolation up to 500 V
- CAN termination can be activated through a solder jumper
- Measurement of bus load including error frames and overload frames
- Induced error generation for incoming and outgoing CAN messages
- 5-Volt supply to the CAN connection can be connected through a solder jumper, e.g. for external bus converter
- Voltage supply via USB
- Extended operating temperature range from -40 to 85 °C (-40 to 185 °F)
- DB9 Pin Assignments

Pin	Signal
1	not connected / optional +5V
2	CAN-L
3	GND
4	not connected
5	not connected
6	GND
7	CAN-H
8	not connected
9	not connected

Table 15-1: CAN-FD USB adaptor DB9 Pin Assignments

15.2.2 CAN-FD Adaptor Technical Specifications

Item	Specifications
Dimensions	75 x 43 x 22 mm
Product Weight	68 grams
Baud Rate	CAN: 40 kBit/s - 1 MBit/s, CAN FD: 40 kBit/s - 12 MBit/s
Storage Specifications	Temperature: -40°C to +100°C
Power Consumption	max. 100 mA
Certifications	CE, RoHS
Pinout	C.I.A. DS-102 (CAN_H = 7, CAN_L = 2, CAN_GND = 3)
Enclosure	IP20, Plastic Enclosure

Item	Specifications
Transceiver	CAN: NXP TJA1044GT
EMC Directive	EN 55024:2011-09, EN 55022:2011-12, EC directive 2004/108/EG
Software	Driver: Windows® 10, 8.1, 7 and Linux (32/64-bit) Tools: PCAN-View for Windows®
Controller(s)	FPGA implementation
Time stamp resolution	1 microsecond
Specification	CAN FD 1.0 (compatible with CAN 2.0)
Connector(s)	PC: High-Speed USB 2.0 (compatible to USB 1.1 and 3.0) CAN: ISO 11898-2, complies with CiA-recommendation DS 102
Operating Conditions	Temp. Range: -40°C to +85°C Humidity: 15% to 90% (non-condensing)

Table 15-2: CAN-FD USB Adaptor Technical Specs

15.3 CAN / CAN-FD Configuration File

A CAN DBC file (CAN database) is a text file that contains information for decoding raw CAN bus data to 'physical values'. To understand what 'raw CAN data' looks like, see the below example CAN frame from a truck:

CAN ID	Data bytes
OCF00400	FF FF FF 68 13 FF FF FF

If you have a CAN DBC that contains decoding rules for the CAN ID, you can 'extract' parameters (signals) from the data bytes. One such signal could be EngineSpeed:

Message	Signal	Value	Unit
EEC1	EngineSpeed	621	rpm

On a CAN or CAN FD network, the messages used on the CAN bus are defined by the user. Each message has an ID and specific signals that apply to it. Pacific Power only provides all the signals available for the interface adaptor device.

There are some environment variables that need to be configured such as the baud-rate and the CAN or CAN FD protocol. This information is provided in a database file that must be loaded on the interface adaptor, so it is configured based on its content.

15.4 Downloading and installing the canfd.dcb file

The file can be opened with Vector CANdb++ Editor which is free to use.

<https://www.vector.com/int/en/products/products-a-z/software/canbd/>

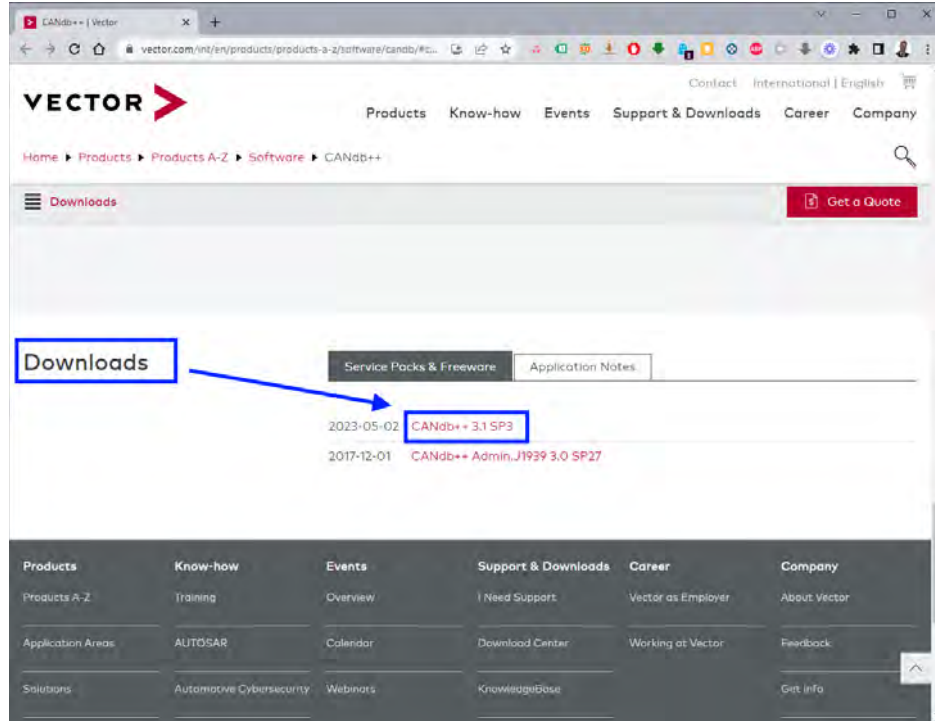

Scroll Down to bottom of the page:

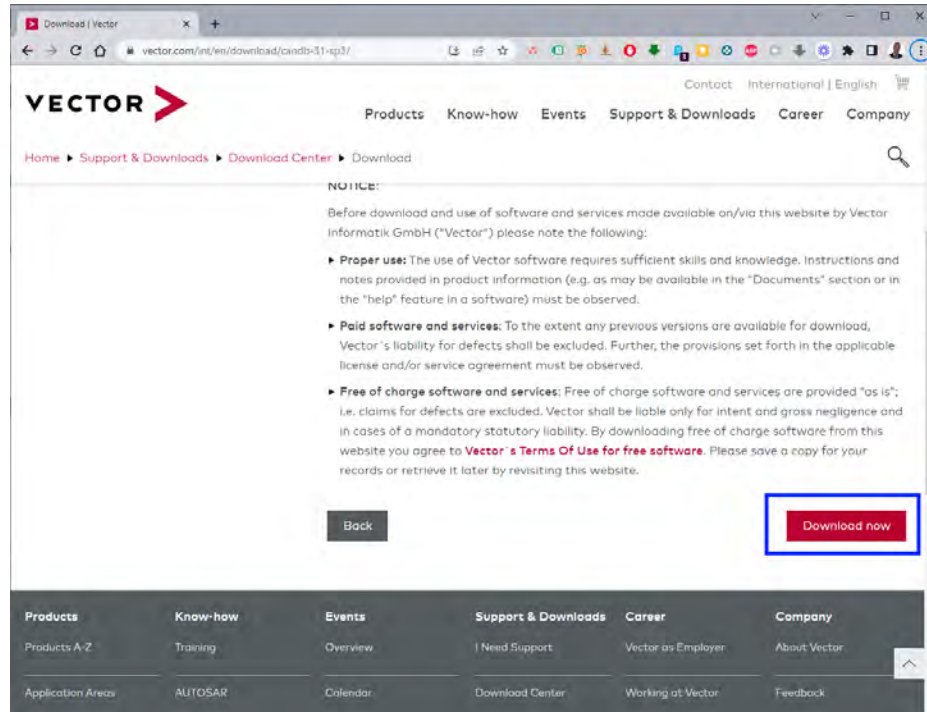

When pressing **download** you should get the default canfd.dcb with all available signals.

15.5 Vector CANdb++ Editor Windows Software

To install the Editor, run the “VectorCANdb-plusplus_3.1.025_SP3.exe” installation from your download folder. Run the Installer when prompted. Either English or German version is selectable.

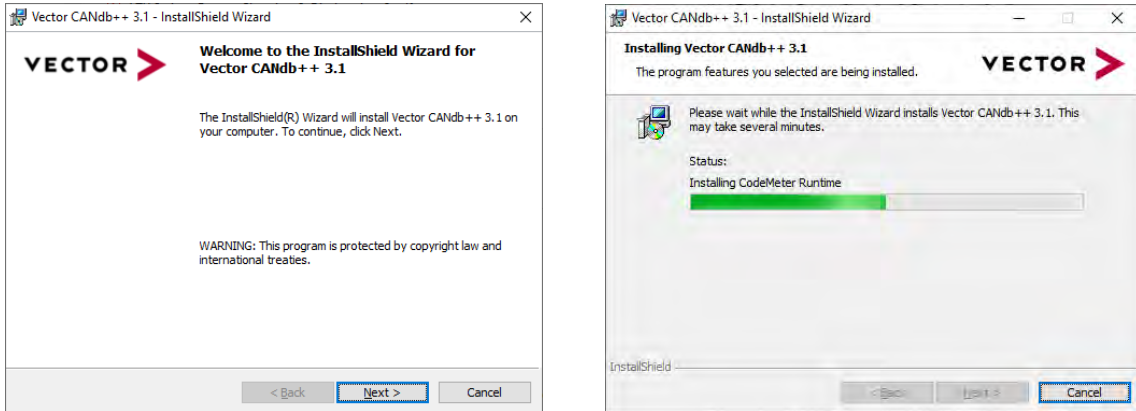

Signals should be self-explanatory and have a description. Once downloaded, this database can be uploaded and will automatically load it and persist.

The next download will download the modified database.

The speed and CAN standard (regular CAN or CAN FD) can be selected with environment variables.

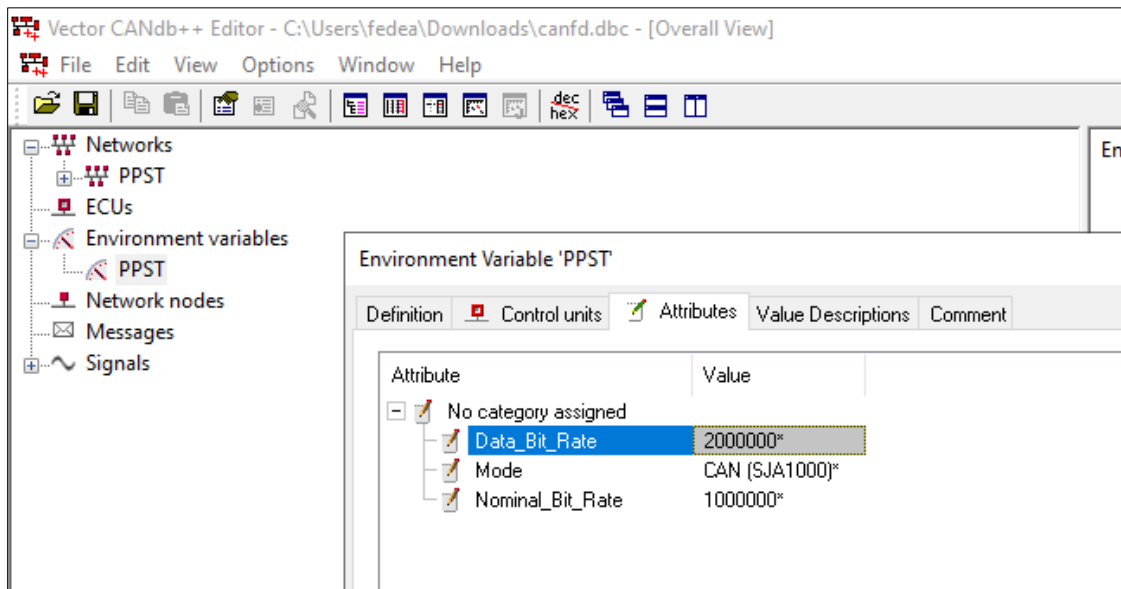

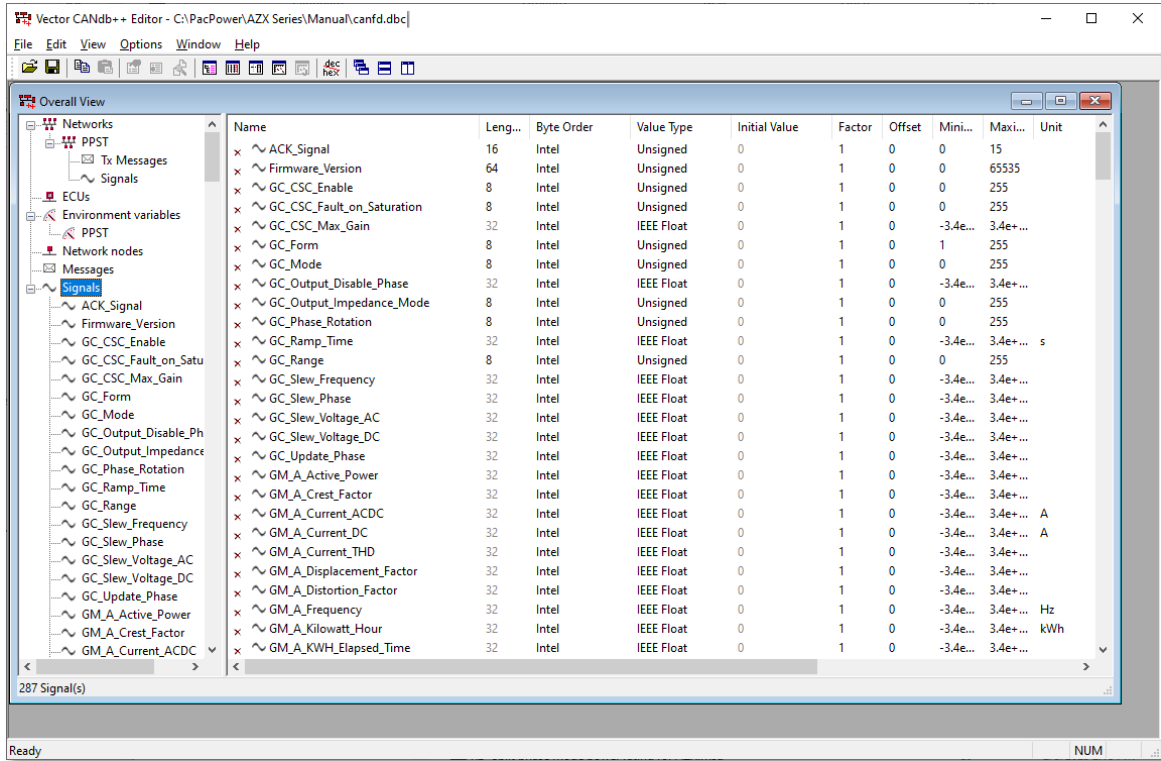

The messages must be created by the user using any of the available signals.

Signals starting with PM_* are periodic measurements. If the MEASURE ENABLE checkbox is enabled the unit will periodically emit the measurements.

The rate is given by the MEASURE RATE and is in multiples of the RMS windows which is close to 100ms. So for example, if the rate is 1 it will emit the measurements at 100ms, if the rate is 2 at 200ms, and so on.

15.6 Enabling or Disabling the CAN / CAN-FD interface

The CAN/CAN-FD interface can be enabled from the browser interface on units that have Firmware revision 4.2.0 or higher. If connected to the power source via LAN, enter the IP address for the power source in the address bar. Then go to SYSTEM -> INTERFACE SETUP and locate the CAN FD settings. Use the CANDF ENABLE slider to turn the interface ON or OFF.



The DCB Configuration file can be uploaded or downloaded using the “UPLOAD” or “DOWNLOAD” buttons.

The MEASURE ENABLE function - when enabled - provides measurements from the CAN/CAN based on signals starting with PM_* These are periodic measurements.

If the MEASURE ENABLE checkbox is enabled the unit will periodically emit the measurements.

The rate is given by the MEASURE RATE and is in multiples of the RMS windows which is close to 100ms. So for example, if the rate is 1 it will emit the measurements at 100ms, if the rate is 2 at 200ms, and so on.

SCPI Commands for CAN-FD Interface

The CAN/CAN-FD interface can also be enabled by sending a SCPI command to the power source from its web browser interface.

Relevant SCPI commands are listed in section 8.11.12, “Communication CAN / CAN-FD Commands” on page 513 of this manual.

16 CE MARK Declaration of Conformity

The Manufacturer hereby declares that the products:

Product Name: AZX Series® AC & DC Power Sources, All Models in Series

Conforms to the following standards or other normative documents:

RoHS (DIRECTIVE 2011/65/EU)

Standard applied EN 50581:2012

SAFETY (DIRECTIVE 2014/35/EC):

Standard applied EN 61010-1: 2010; ED3/A1:2019

EMC (DIRECTIVE 2014/30/EU):

Standard applied EN 61326-1: 2013

Reference Standards:

ELECTROMAGNETIC EMISSIONS:

Radiated Emissions CISPR 11/22, CLASS A LIMITS
Conducted Emissions CISPR 11/22, CLASS A LIMITS

ELECTROMAGNETIC IMMUNITY:

RF Electromagnetic Field IEC 61000-4-3:2006+A1:2007+A2:2010
80 – 1000 MHz, 10 V/m
1 Khz sinewave (80% AM) 1.4 – 2 GHz, 3 V/m
2.0 – 2.7 GHz, 1 V/m

Conducted RF Immunity IEC 61000-4-6:2013
Conducted RF Immunity 0.15 – 80 MHz @ 3 Vrms

Electrostatic Discharge IEC 61000-4-2:2008
± 4 kV contact discharge
± 8 kV air discharge

Electrical Fast Transient/Burst IEC 61000-4-4:2004+A1:2010
AC or DC power ports, ± 2.0 kV
Signal and I/O ports, ± 1.0 kV

Surge IEC 61000-4-5:2006
AC or DC power ports, ± 2.0 kV Line to ground and ± 1.0 kV Line to Line

Power Frequency Magnetic Field IEC 61000-4-8:2009
30 A/m

Supplemental Information:

When and Where Issued January 17, 2021
Irvine, California, USA

Authorized Signatory 
Mitchel Orr,
Quality Manager, acting
Pacific Power Source

Responsible Person Joe Abranko,
Pacific Power Source, Inc.
2802 Kelvin Avenue, Suite 100, Irvine CA, 92614

Mark of Compliance



Index

A

AC Input	59, 67, 76
AC terminal block.....	71
accessories	
included	39
Accessories.....	39
air filter	80
Airflow.....	78

B

B Option	25
Browser	556
Remote Interface.....	627

C

C Option	25
Calibration	635
Commands.....	246
CAN Interface.....	689
CAN-FD.....	689
CE MARK.....	696
Circuit Breaker	77
CONFIGURATION	
Screens	174
Configuration Settings.....	175
Connections	216
Console	
SCPI	206
Constant Current.....	30
Constant Power	33
Constant Resistance.....	31
Contact	16, 98, 672
Contents.....	3
CSC Configuration.....	183
CSV files	
Transient List Import/Export.....	578
Cycle Reset.....	184

D

D Option	25
Date formats.....	517
DC Output	
Series Connections.....	95
Decimal separator.....	517
Deviation	
commands.....	311
setpoints	140
Web Browser.....	585

E

E Version.....	42
Electronic load	

AC Source connections.....	92
Emergency	
Shutdown.....	78
equipment weight	66
Error and Event queue	190
Error Messages	643
Ethernet	102
Access Control.....	558
Export Version	42
Extended High Frequency	50
Extended Low Frequency	49
External Sync Output	231
External Voltage Sense.....	218

F

Fault Queue.....	190
FB1 and FB2 Connection.....	97
Features.....	24
File Manager.....	210
Filter	
Air Intake	81
Firmware Update.....	214
FORM	129
front panel operation.....	103

H

H Option.....	25, 65
HIL option.....	39

I

IEC 61000-4-13 Interharmonics.....	139
Import	
Transient List	578
Inrush Current Simulation Mode.....	38
Installation.....	17, 66, 554
Interface	
CAN-FD Interface	689
Ethernet Browser.....	556
GPIB Settings	201
I/O Settings	201
Monitor	105
Remote Inhibit Settings	202
RS232 Settings.....	199
Screens.....	191
USB Settings	200

K

Keyboard	104
Touchscreen	194

L

L Option	25
LAN 102	
Access Control.....	558

Browser Interface.....	556	Program	
Configuration.....	556	Impedance.....	185
Setup.....	197	PROGRAM	
LAN Configuration.....	556	Screen.....	107
LCD Image		Soft Keys.....	130
capture to image file.....	104	Program Data Entry.....	127
Logging measurement data.....	148	Program Memory.....	182
M		Programming.....	103, 243
Maintenance		Conventions.....	243
Air Filter Cleaning.....	80	Terminators.....	244
Managing		Protection.....	57
Files210		R	
Manual.....	566	Rear Panel	
Measurement Command		Connector Locations.....	101
Resolution Setting.....	268	Recommended Wire Sizing.....	84
Measurements		Regional setting.....	517
Datalogger.....	146	Remote Control.....	243
MEASUREMENTS		RS232	
Logging.....	215	Interface.....	199
Plotting.....	151	S	
Screen.....	143	safety information.....	17
Soft Keys.....	146, 149	Safety Information.....	17
Memory		Safety Notices.....	19
SD Card.....	105	SCIP Console.....	206
USB105		Screen capture	
Memory Management.....	208	LCD Image.....	630
Menus.....	106	SD Card.....	105
ModBus		Sense Terminals.....	218
TCP.....	673	Service.....	671
O		Shuttle.....	104
Option		Size 217	
B.....	25	Slew Rates.....	180
C.....	25	Specifications.....	40
D.....	25	Start Phase.....	176
H.....	25	Startup Procedure	
L.....	25	Power On.....	73
W.....	25	Status Monitor	
optional output transformer.....	177	Safety Circuit.....	74
Output		Stop Phase.....	176
Enable Button.....	104	SYSTEM	
Impedance.....	185	Screens.....	188
Output Enable.....	106	system bus.....	99
Output Impedance.....	185	T	
P		Terminals.....	216
Parallel Operation.....	98	Terminator Characters.....	244
Phase Angle		Test Sequences	
Control.....	176	Browser Interface.....	595
Phase Mode.....	129	SCPI Commands.....	542
phase rotation		Touchscreen Keyboard.....	194
positive or negative.....	178	Transformer	
Phase rotation.....	126	Option.....	300, 494
Powering Up.....	97	Transient Settings.....	184
Presets			
Output Parameters.....	127		

TRANSIENTS		Virtual Front Panel	
Screens	152	Browser	627
Turn on	98	voltage sense	
U		External	97
UNIT INFORMATION.....	204	Internal	97
unpacking.....	66	W	
Update Phase	176	W Option.....	25
USB		Warranty	17
Drivers	554	Waveform	
USB.....	101	Library	134
User Limits	179	Weight.....	60
User Presets	186	Wire Size.....	217
V		Wire Sizing	
Video Monitor	105	Recommended.....	84



Pacific Power Source

The Power of Expertise