

# Operation Manual

LSX Series™ – P/N 136050-10 Rev 1.0.5

## LSX Series™ Programmable AC Power Source



 **PACIFIC POWER SOURCE** **PACIFIC POWER SOURCE**

Worldwide Supplier of Precision Programmable Power

Copyright © 2023, Pacific Power Source, Inc. (PPS) • All Rights Reserved • No reproduction without written authorization from PPS.

## GENERAL DISCLAIMER

Pacific Power Source, Inc. reserves the right to revise this documentation and to make changes in content from time to time without obligation on the part of Pacific Power Source, Inc. to provide notification of such revision or change. This publication may include technical or other inaccuracies or typographical errors. Furthermore, changes are periodically added to the information herein; these changes will be incorporated in new editions of the publication. Pacific Power Source, Inc. may make improvements and/or changes in the operation, features, functions and/or technical specifications described in this publication at any time.

## Table of Contents

<b>1</b>	<b>Contact Information .....</b>	<b>15</b>
<b>2</b>	<b>Safety &amp; Warranty Information .....</b>	<b>16</b>
2.1	Limited Warranty .....	16
2.2	Service and Spare Parts Limited Warranty .....	16
2.3	Safety Information.....	16
2.4	Safety Notices .....	18
<b>3</b>	<b>Product Overview .....</b>	<b>23</b>
3.1	General Description.....	23
3.2	Available LSX Models.....	23
3.3	M Version Models (LSXM) .....	24
3.4	Product Features .....	25
3.5	Controller Description .....	25
3.6	Measurement Read-back .....	26
3.7	Accessories Included (Ship Kit) .....	26
<b>4</b>	<b>Technical Specifications .....</b>	<b>27</b>
4.1	Available Models – Power & Voltage Ranges .....	27
4.1.1	Single Phase Models – Direct Coupled Output .....	27
4.1.2	Single Phase Models – Transformer Output .....	27
4.1.3	Three Phase Models – Direct Coupled Output .....	28
4.1.4	Three Phase Models – Transformer Output .....	28
4.2	AC Output Current Ratings by Model.....	29
4.2.1	Output Rating Charts Single-Phase Models .....	30
4.2.2	Output Rating Charts Three-Phase Models .....	34
4.3	Overload Operation .....	38
4.4	AC Output – All Models.....	38
4.4.1	Export Option Frequency Resolution .....	40
4.4.2	Programmable Output Impedance Ranges by Phase Mode.....	40
4.4.3	Programmable Impedance operation.....	40
4.5	Low Frequency Operating in Transformer Coupled Mode .....	41
4.6	Protection Modes.....	43
4.7	Metering .....	43
4.8	Other Measurements.....	44
4.9	Transient Programming .....	44
4.10	AC Input Power Requirements .....	45
4.10.1	115LSX AC Input.....	45
4.10.2	120LSX AC Input.....	45
4.10.3	140LSX AC Input.....	46
4.10.4	160LSX AC Input.....	46
4.10.5	315LSX AC Input.....	46
4.10.6	320LSX AC Input.....	47
4.10.7	345LSX AC Input.....	47
4.10.8	360LSX AC Input.....	47
4.11	Dimensions & Weight by Model.....	48
4.11.1	Rack Handles.....	48
4.11.2	Rack Mount Slides .....	48
4.11.3	Chassis Drawings – 3U - 115LSX & 315LSX.....	49
4.11.4	Chassis Drawings – 3U – 120LSX & 320LSX .....	50
4.11.5	Chassis Drawings – 5U 140LSX, 345LSX, 160LSX & 360LSX .....	51
4.11.6	Chassis Drawings – T Option Magnetics Module 3U .....	52

4.12	Environmental .....	53
4.13	Digital Interfaces.....	53
4.14	Auxiliary I/O .....	55
<b>5</b>	<b>Unpacking and Installation .....</b>	<b>57</b>
5.1	Unpacking .....	57
5.2	Inspection .....	57
5.3	Lifting and Carrying Instructions.....	57
5.4	Chassis Placement.....	58
5.5	Verify Correct AC Input Line Voltage.....	59
5.6	AC Input Connections.....	59
5.6.1	Input Voltage Configuration – Model 115LSX.....	60
5.6.2	Input Voltage Configuration – Models 120LSX & 320LSX .....	62
5.6.1	Input Voltage Configuration – Model 315LSX.....	64
5.6.2	Input Voltage Configuration – Model 140, 160, 345 and 360LSX.....	66
5.6.3	Input Power Wiring Requirements.....	68
5.6.4	Terminal Block Types by Model.....	70
5.7	Grounding Requirements .....	71
5.7.1	Chassis Ground Connection Required.....	71
5.7.2	Output Neutral Grounding.....	71
5.8	AC Input Circuit Breaker.....	72
5.9	Cleaning.....	72
5.10	Air Intake Filter Removal and Cleaning .....	73
5.10.1	Air Filter Removal .....	73
5.10.2	Filter Cleaning .....	73
5.10.3	Air Filter Installation.....	73
5.11	Liquids .....	73
5.12	Transformer Output Voltage Configurations.....	74
5.12.1	Output Voltage Configuration Model 115LSX.....	75
5.12.2	Output Voltage Configuration Model 120LSX.....	77
5.12.3	Output Voltage Configuration Model 315LSX.....	77
5.12.4	Output Voltage Configuration Models 140, 160, 345 & 360LSX.....	79
5.13	Load Connections .....	82
5.13.1	Single Phase Output .....	83
5.13.2	Split Phase Output .....	84
5.13.3	Three Phase Output .....	86
5.13.4	External Voltage Sense Connections .....	89
5.14	Transformer Coupled Output .....	91
5.14.1	Neutral Grounding.....	91
5.14.2	Low Frequency Operating in Transformer Coupled Mode .....	91
5.15	Powering Up .....	92
5.15.1	In Case of Malfunction .....	92
5.16	Interface Connections .....	93
5.16.1	USB Device Interface .....	93
5.16.2	GPIB Device Interface .....	93
5.16.3	LAN Interface .....	94
5.16.4	Auxiliary I/O Connections.....	94
<b>6</b>	<b>Front Panel Operation .....</b>	<b>95</b>
6.1	Front Panel Layout .....	95
6.1.1	Keyboard Buttons.....	96
6.1.2	Shuttle Knob.....	97
6.1.3	PC Monitor Output.....	97
6.1.4	USB Host Ports.....	97

6.1.5	SD Card Memory Slot .....	97
6.2	OUTPUT ENABLE Button .....	98
6.2.1	OUTPUT State Indication.....	98
6.2.2	Output On Response Times .....	98
6.3	Menu Keys .....	98
6.4	PROG – PROGRAM & MEASUREMENTS Screen .....	99
6.4.1	Power On Settings .....	100
6.4.2	PROGRAM Output Parameters.....	101
6.4.3	Phase Rotation / Phase Sequence .....	102
6.4.4	Direct Data Entry - Presets .....	103
6.4.5	Customizing Output Programming Preset Soft Key Values.....	104
6.4.6	Changing Shuttle Programming Resolution .....	104
6.4.7	PROGRAM & MEASUREMENTS Soft Keys.....	105
6.4.8	Available Waveforms .....	109
6.4.9	Waveform Smoothing Filter.....	111
6.4.10	AUTO RMS Function – Steady State .....	112
6.5	MEAS – MEASUREMENTS Screens .....	114
6.5.1	Measurements Screens.....	114
6.5.2	Scope Measurements .....	115
6.5.3	Harmonic Measurements .....	116
6.5.4	Measurement Screen Soft Keys.....	117
6.5.5	Measurement Data Logging.....	119
6.6	TRAN- TRANSIENTS Screens .....	120
6.6.1	LIST Mode .....	120
6.6.2	LIST Parameters .....	121
6.6.3	LIST Transient Edit Mode .....	124
6.6.4	LIST Transient Execution Modes.....	125
6.6.5	LIST Transient Entry Modes .....	127
6.6.6	Multiple User Waveforms in Transients.....	128
6.6.7	STEP or RAMP Modes.....	129
6.6.8	STEP or RAMP Parameters.....	130
6.6.9	STEP or RAMP Transient Execution Modes.....	131
6.6.10	PULSE Mode.....	132
6.6.11	PULSE Parameters .....	133
6.6.12	PULSE Transient Execution Modes.....	134
6.6.13	AUTO RMS Function – Transients.....	135
6.7	CONF – CONFIGURATION Screens .....	136
6.7.1	UNIT CONFIGURATION Screens.....	138
6.7.2	USER LIMITS SETTINGS Screen.....	142
6.7.3	RAMP TIME & SLEW RATE SETTINGS Screen .....	143
6.7.4	PROGRAM MEMORY Screen .....	145
6.7.5	CSC CONFIGURATION Screen .....	146
6.7.6	TRANSIENT SETTINGS Screen.....	147
6.7.7	STEP or RAMP Modes.....	148
6.7.8	STEP or RAMP Parameters.....	149
6.7.9	STEP or RAMP Transient Execution Modes.....	150
6.7.10	PULSE Mode.....	151
6.7.11	PULSE Parameters .....	152
6.7.12	PULSE Transient Execution Modes.....	153
6.7.13	OUTPUT IMPEDANCE Screen.....	155
6.7.14	USER PRESETS Screen.....	156
6.8	SYST – SYSTEM Screens .....	158
6.8.1	SYSTEM MENU 1.....	159
6.8.2	SYSTEM MENU 2.....	159

6.8.3	ERROR / EVENT QUEUE Screen .....	160
6.8.4	FAULT INFORMATION Screen.....	160
6.8.5	INTERFACE Screen .....	161
6.8.6	UNIT INFORMATION Screen .....	172
6.8.7	SCPI CONSOLE.....	174
6.8.8	SYSTEM SETTINGS Screen .....	175
6.8.9	MEMORY MANAGEMENT Screen .....	176
6.8.10	CALIBRATION MENU Screen .....	181
6.8.11	FIRMWARE UPDATE Screen.....	182
6.8.12	REMOTE SUPPORT Screen .....	183
<b>7</b>	<b>Auxiliary I/O .....</b>	<b>184</b>
7.1	Preface .....	184
7.2	Connector Location and Pin Designations .....	184
7.2.1	DB25 Connector AUX I/O Pin locations .....	184
7.2.2	I/O Signal Table by pin number.....	185
7.2.3	I/O Signal Table by Function .....	186
7.3	Dedicated Function Digital Inputs .....	187
7.3.1	Remote Inhibit .....	187
7.4	Transient Trigger Input.....	188
7.5	External Sync Input.....	189
7.5.1	Principle of Operation .....	189
7.5.2	SYNC Status Display .....	191
7.5.3	Sync Operation Settings .....	191
7.6	Digital Output control signals .....	192
7.6.1	Function Strobe / Trigger Out .....	192
7.6.2	Phase Sync Output / External Sync Output .....	194
7.7	User Programmable Digital signals.....	195
7.7.1	Relay Control Outputs .....	195
7.7.2	Digital User Inputs .....	196
7.7.3	Digital User Outputs .....	196
7.8	Analog I/O Descriptions .....	197
7.8.1	Analog Inputs .....	197
7.8.2	Programming Analog Inputs .....	197
7.8.3	Analog Outputs.....	198
7.9	Analog Input Modes.....	198
7.10	12 DC Power Supply .....	201
7.11	RS232 Description .....	201
7.12	Front Panel Operation of AUX I/O Functions.....	202
7.12.1	Accessing AUX I/O Screens.....	202
7.12.2	Analog Inputs .....	203
7.12.3	Analog Outputs.....	204
7.12.4	Digital Inputs .....	205
7.12.5	Digital Outputs.....	205
7.12.6	Polarity Selection for DO3 and DO4 vs DO1 and DO2.....	206
7.12.7	External Sync.....	207
7.12.8	Trigger Input.....	207
7.12.9	Strobe Output .....	208
7.12.10	Remote Control .....	208
<b>8</b>	<b>Remote Control Programming.....</b>	<b>209</b>
8.1	Overview .....	209
8.1.1	Programming Conventions and Notations.....	209
8.1.2	Command Terminators .....	210
8.2	Remote Control Command Descriptions by Subsystem .....	211

8.3	Calibration Commands.....	212
8.3.1	LSX Calibration Commands.....	212
8.3.2	UPC Specific commands.....	214
8.3.3	AUX I/O Interface Calibration Commands.....	214
8.4	Measurement Commands.....	215
8.4.1	Voltage Measurement Commands.....	215
8.4.2	Frequency Measurement Commands.....	216
8.4.3	Current Measurement Commands.....	216
8.4.4	Power Measurement Commands.....	218
8.4.5	KWh Measurement Commands.....	218
8.4.6	Other Measurement Commands.....	220
8.4.7	Measurement Data Logging Commands.....	221
8.4.8	Waveform Capture Commands.....	224
8.4.9	Harmonic Measurements Commands.....	226
8.4.10	Measurement Resolution Setting Commands.....	231
8.5	Output Control Commands.....	233
8.6	Program Commands.....	237
8.6.1	Program Control Commands.....	237
8.6.2	Execution Commands.....	248
8.6.3	Transient Segments Commands.....	249
8.6.4	Memory Management Commands.....	254
8.7	Source Commands.....	257
8.7.1	Source Configuration Programming Commands.....	257
8.7.2	Voltage Programming Commands.....	261
8.7.3	Real Time Voltage Slew Rate Programming Commands.....	266
8.7.4	Frequency Programming Commands.....	268
8.7.5	Current Programming Commands.....	269
8.7.6	Phase Programming Commands.....	272
8.7.7	Waveform Programming Commands.....	274
8.7.8	Voltage Protection Programming Commands.....	282
8.7.9	Voltage Sense Protection Commands.....	287
8.7.10	Current Protection Programming Commands.....	288
8.7.11	Power Protection Programming Commands.....	293
8.7.1	Frequency Protection Programming Commands.....	298
8.7.2	Impedance Programming Commands.....	299
8.7.3	STEP Transient Commands.....	302
8.7.4	PULSE Transient Commands.....	319
8.7.5	Interharmonics Commands (IEC61000-4-13 Option C).....	330
8.8	Status Commands.....	334
8.9	System Commands.....	336
8.9.1	System Error Commands.....	336
8.9.2	System Information Commands.....	338
8.9.3	System Interface Soft Key Preset Commands.....	342
8.9.4	System Configuration Commands.....	346
8.9.5	Parallel System Commands.....	348
8.9.6	System Sanitization Commands.....	349
8.9.7	Communication LAN Commands.....	349
8.9.8	Communication Serial Port Commands.....	353
8.9.9	Communication USB Commands.....	354
8.9.10	Communication GPIB Commands.....	356
8.9.11	System Firmware Commands.....	357
8.9.12	System Remote Access Commands.....	358
8.9.13	System Regional Setting Commands.....	360
8.9.14	Miscellaneous System Commands.....	360

8.9.15	System Import / Export Commands .....	362
8.9.16	Miscellaneous Remote Restart Commands .....	362
<b>8.10</b>	<b>Auxiliary I/O System Commands .....</b>	<b>363</b>
8.10.1	Analog & Digital IO Programming Commands .....	363
8.10.2	SOURce:SYNChronize Commands .....	376
8.10.3	PROGram:TRANSient Triggers Commands .....	379
8.10.4	Analog Input Commands .....	381
8.10.5	AUX I/O Calibration Commands .....	383
8.11	Test Sequence Commands .....	387
8.12	IEEE488.2 Common Commands .....	390
8.13	Status and Events Registers .....	394
8.13.1	Status Byte Register (STB) .....	394
8.13.2	Status Event Register (ESR) .....	396
8.13.3	SCPI Status Registers .....	397
<b>9</b>	<b>USB Driver Installation .....</b>	<b>399</b>
9.1	Overview .....	399
9.2	Installation .....	399
<b>10</b>	<b>LAN Interface Configuration .....</b>	<b>401</b>
10.1	Overview .....	401
10.2	Web Browser Interface .....	401
10.3	Access Control .....	403
10.3.1	Browser Access Control .....	404
10.3.2	Front Panel Access Control .....	408
10.4	Web Browser Interface .....	409
10.5	Available Web Interface Menu Tree .....	409
10.6	Home Screen .....	410
10.6.1	SCPI Console Command Line Interface .....	410
10.6.2	Status Byte Display .....	411
10.6.3	Browser Status Bar .....	411
10.6.4	Operation Manual PDF .....	411
10.6.5	Language Selection .....	411
10.7	Source Control Screens .....	412
10.7.1	Program .....	413
10.7.2	Protections .....	414
10.7.3	Transients .....	415
10.7.4	Analog Programming .....	421
10.7.5	Interharmonic & Harmonic .....	422
10.7.6	Setpoint Deviation .....	423
10.7.7	Program Memory .....	426
10.7.8	Waveform .....	427
10.7.9	Waveform Editor .....	428
10.7.10	Test Sequence .....	433
10.7.11	SCPI Script .....	435
10.8	Measurement Screens .....	437
10.8.1	Monitor .....	438
10.8.2	Real-Time Plot .....	439
10.8.3	V/I Plot .....	440
10.8.4	Data Logger .....	441
10.8.5	Scope .....	442
10.8.6	Harmonics .....	446
10.9	Configuration Screens .....	447
10.9.1	Unit Settings .....	448
10.9.2	User Limits & Presets .....	449



10.9.3	Ramp Time & Slew Rate.....	450
<b>10.10</b>	<b>System Screens.....</b>	<b>451</b>
10.10.1	Error/Event Queue.....	452
10.10.2	Fault List.....	453
10.10.3	Error/Event List.....	454
10.10.4	Interface Setup.....	455
10.10.5	Access Control.....	456
10.10.6	Digital & Analog IO's.....	457
10.10.7	Remote Interface (Virtual Front Panel).....	461
10.10.8	Unit Information.....	462
10.10.9	Connected Units.....	463
10.10.10	Memory Browser.....	464
10.10.11	Calibration.....	465
10.10.12	Remote Support.....	466
10.10.13	Import / Export.....	466
10.10.14	Firmware Update.....	467
10.10.15	Sanitize and Reboot.....	468
10.11	Additional Functions.....	468
<b>11</b>	<b>Calibration.....</b>	<b>469</b>
11.1	Calibration Interval.....	469
11.2	Closed Case User Calibration.....	469
11.3	Equipment Required.....	469
11.4	Calibration Procedures.....	469
11.4.1	Voltage Calibration - Offset.....	470
11.4.2	Current Calibration – Offset (Direct Coupled V Range).....	471
11.4.3	Voltage Calibration - Gain.....	472
11.4.4	Current Gain Calibration Setup Diagrams.....	474
11.4.1	Current Calibration Load Values.....	476
11.4.2	Current Calibration - Gain.....	477
11.4.3	Exit Calibration Mode.....	477
<b>12</b>	<b>Warnings &amp; Error Messages.....</b>	<b>478</b>
12.1	Preface.....	478
12.2	Errors & Warnings Messages in Numeric Order.....	478
<b>13</b>	<b>Service and Maintenance.....</b>	<b>503</b>
13.1	Warnings.....	503
13.2	Authorized Service Centers.....	504
<b>14</b>	<b>ModBus TCP Server / Slave Interface.....</b>	<b>505</b>
14.1	ModBus TCP Interface.....	505
14.2	Modbus TCP Register Tables.....	505
14.3	ModBus Control Example using Python.....	519
<b>15</b>	<b>CE MARK Declaration of Conformity.....</b>	<b>520</b>
	<b>Index.....</b>	<b>521</b>

## Table of Tables

Table 3-1: Feature comparison between LSX and LSXM Models .....	25
Table 3-2: Included Accessories .....	26
Table 4-1: AC Output RMS & Peak Current Rating by Model .....	29
Table 4-2: Programmable Impedance Ranges by Phase mode .....	40
Table 5-1: Required ventilation clearances by model .....	58
Table 5-2: GPIB Interface Connector Pin Assignments .....	93
Table 6-1: Available Menu Keys.....	98
Table 6-2: Available Output Parameters on PROGRAM screen.....	101
Table 6-3: Changing Programming Resolution .....	104
Table 6-4: PROGRAM screen soft keys .....	108
Table 6-5: Available Included LSX Series® Waveforms .....	110
Table 6-6: Three Phase Measurement Screen Soft Keys.....	118
Table 6-7: Available Transient List Parameters .....	121
Table 6-8: Voltage Transient List for Example 1 .....	122
Table 6-9: RTCA/DO160 Section 16 test number 16.5.2.1d .....	123
Table 6-10: Voltage Transient List for Example 1 .....	123
Table 6-11: Available TRANSIENT EDIT screen soft keys .....	125
Table 6-12: Available TRANSIENT DEBUG screen soft keys .....	125
Table 6-13: Available TRANSIENT PROGRAM screen soft keys .....	126
Table 6-14: Available STEP Transient Parameters .....	130
Table 6-15: Available STEP PROGRAM screen soft keys.....	130
Table 6-16: Available STEP EXECUTION screen soft keys .....	131
Table 6-17: Available STEP Transient Parameters .....	133
Table 6-18: Available STEP PROGRAM screen soft keys.....	133
Table 6-19: Available STEP PROGRAM screen soft keys.....	134
Table 6-20: Available UNIT CONFIGURATION 1 screen soft keys .....	139
Table 6-21: Available UNIT CONFIGURATION 2 screen soft keys .....	141
Table 6-22: Available USER LIMITS SETTINGS screen soft keys .....	142
Table 6-23: Available RAMP TIME & SLEW RATE SETTINGS screen soft keys .....	144
Table 6-24: Available SLEW RATE SETTINGS screen soft keys .....	146
Table 6-25: Available CSC CONFIGURATION screen soft keys .....	146
Table 6-26: Available TRANSIENT SETTINGS screen soft keys .....	154
Table 6-27: Available PROGRAMMABLE IMPEDANCE screen soft keys .....	155
Table 6-28: Available USER INTERFACE screen soft keys.....	163
Table 6-29: Available USER INTERFACE screen soft keys.....	166
Table 6-30: Available ETHERNET INTERFACE SETUP screen soft keys .....	168
Table 6-31: Available SERIAL INTERFACE SETUP screen soft keys .....	169
Table 6-32: Available USB INTERFACE SETUP screen soft keys .....	169
Table 6-33: Available GPIB INTERFACE SETUP screen soft keys .....	170
Table 6-34: Available UNIT INFORMATION screen soft keys.....	172
Table 6-35: Available PARALLEL UNITS screen soft keys .....	173
Table 6-36: Available SYSTEM SETTINGS screen soft keys .....	176
Table 6-37: Available CALIBRATION MENU screen soft keys.....	182
Table 6-38: Available FIRMWARE UPDATE screen soft keys .....	182

---

Table 6-39: Available LOGGING TOOL screen soft keys.....	183
Table 7-1: Auxiliary I/O DB25 Connector Pin numbers and Signals by DB25 pin number.....	185
Table 7-2: Auxiliary I/O DB25 Connector Pin numbers and Signals by Signal Name.....	186
Table 7-3: Default Analog Output Functions.....	198
Table 7-4: AUX I/O Analog Input assignable Commands.....	203
Table 7-5: AUX I/O Digital Output assignable Events or Conditions.....	206
Table 8-1: Available SCPI Command Subsystems.....	211
Table 8-2: Available Included LSX Series® Waveforms.....	275
Table 8-3: Mandatory IEEE488.2 Common Commands.....	390
Table 8-4: Status Byte Register (STB).....	394
Table 8-5: Status Event Register (ESR).....	396
Table 10-1: Supported Script Entries.....	435
Table 11-1: Required Calibration Equipment.....	469
Table 11-2: Setup for Voltage Offset Calibration.....	470
Table 11-3: Calibration Load Values by Model and Phase Mode.....	476
Table 12-1: Warnings and Error Messages Listing.....	502

## Table of Figures

Figure 4-1: 105LSX Rating Charts.....	30
Figure 4-2: 120LSX Rating Charts.....	31
Figure 4-3: 140LSX Rating Charts.....	32
Figure 4-4: 160LSX Rating Charts.....	33
Figure 4-5: 315LSX Rating Charts.....	34
Figure 4-6: 320LSX Rating Charts.....	35
Figure 4-7: 345LSX Rating Charts.....	36
Figure 4-8: 360LSX Rating Charts.....	37
Figure 4-9: Dimension Drawing Models 115LSX & 315LSX.....	49
Figure 4-10: Dimension Drawing Models 120LSX & 320LSX.....	50
Figure 4-11 Dimension Drawing Models 140LSX, 345LSX, 160LSX & 360LSX.....	51
Figure 4-1: Model 5L18-36 VI Curve.....	57
Figure 5-2: AC Input Transformer Tap Settings – Models 115LSX.....	61
Figure 5-3: AC Input Transformer Tap Settings – Models 120LSX & 320LSX.....	63
Figure 5-4: AC Input Transformer Tap Settings – Model 315LSX.....	65
Figure 5-5: AC Input Transformer Tap Settings – Models 140, 160, 345 and 360LSX.....	67
Figure 5-6: Air Intake Filter Removal.....	73
Figure 5-7: Model 115LSX Output Voltage Range Configuration Connections.....	76
Figure 5-8: Model 315LSX Output Voltage Range Configuration Connections.....	78
Figure 5-9: External Output Transformer Module Chassis Drawing Load Connections.....	80
Figure 5-10: External Output Transformer Module Configuration Jumpers.....	81
Figure 5-11: Single Phase Output Connections – 115LSX & 120LSX Models.....	83
Figure 5-12: Single Phase Output Connections – 140, 160, 345 & 360LSX Models.....	84
Figure 5-13: Split Phase Output Connections – 120LSX, 315LSX, & 320LSX Models.....	85
Figure 5-14: Split Phase Output Connections - 140, 160, 345 & 360LSX Models.....	86
Figure 5-15: Three Phase Output Connections – 315LSX & 320LSX Models.....	87
Figure 5-16: Three Phase Output Connections – 345 & 360LSX Models.....	88
Figure 5-17: External Sense Connections – 3U Chassis Models.....	90
Figure 5-18: External Sense Connections – 5U Chassis Models.....	90
Figure 6-1: LSX Series® Front Panel View.....	95
Figure 6-2: PROGRAM Screen.....	101
Figure 6-3: Three Phase AC mode Default Phase Rotation.....	102
Figure 6-4: Three Phase AC mode Reversed Phase Rotation.....	102
Figure 6-5: Waveform with no Smoothing Filter Applied.....	111
Figure 6-6: Same Waveform with maximum smoothing Filter Applied.....	112
Figure 6-7: Three Phase Measurement Screens.....	114
Figure 6-8: Single Phase Measurement Screens for Phase A and B.....	114
Figure 6-9: Voltage Transient Example 1.....	122
Figure 6-10: RTCA/DO160 Section 16 test number 16.5.2.1d.....	123
Figure 6-11: Blank TRANSIENT PROGRAM screen.....	124
Figure 6-12: TRANSIENT VIEW Edit Mode.....	124
Figure 6-13: TRANSIENT Debug mode screen.....	125
Figure 6-14: Transient shown in STEP Mode.....	127
Figure 6-15: Transient shown in SEGMENT Mode.....	127

Figure 6-16: Available User Waveforms in Transients.....	128
Figure 6-17: USER LIMIT SETTINGS Screen .....	142
Figure 6-18: RAMP TIME & SLEW RATE SETTINGS Screen.....	143
Figure 6-19: PROGRAM MEMORY screen.....	145
Figure 6-20: CSC CONFIGURATION screen .....	146
Figure 6-21: SYSTEM MAIN MENU 1 .....	158
Figure 6-22: SYSTEM MAIN MENU 2 .....	158
Figure 6-23: ERROR & EVENT QUEUE Screen .....	160
Figure 6-24: FAULT INFORMATION screen .....	160
Figure 6-25: INTERFACE SETUP Screen .....	161
Figure 6-26: ETHERNET INTERFACE SETUP Screen .....	167
Figure 6-27: SERIAL INTERFCE SETUP Screen .....	168
Figure 6-28: USB INTERFACE SETUP Screen .....	169
Figure 6-29: USB INTERFACE SETUP Screen .....	170
Figure 6-30: REMOTE INHIBIT Setup Screen.....	171
Figure 6-31: UNIT INFORMATION Screen .....	172
Figure 6-32: PARALLEL UNITS Screen .....	173
Figure 6-33: SYSTEM SETTINGS Screen.....	175
Figure 6-36: MEMORY MANAGMENT Screen.....	176
Figure 6-35: CALIBRATION MENU Screen.....	181
Figure 6-36: FIRMWARE UPDATE Screen .....	182
Figure 6-37: REMOTE SUPPORT Screen.....	183
Figure 6-38: Remote Support REPORT Screen.....	183
Figure 7-1: DB25 Connector AUX I/O Pin Locations .....	184
Figure 7-2: External Trigger Input Timing .....	189
Figure 7-3: External Sync Input Pulses.....	190
Figure 7-4: External Sync Input Sync Status Indication .....	191
Figure 7-5: External Sync Input Sync Lost Status Indication.....	191
Figure 7-6: Transient Trigger Output Pulse .....	193
Figure 7-7: Function Strobe Output Pulse .....	193
Figure 7-8: Phase A Zero Phase Sync Output Pulse .....	194
Figure 7-9: Analog Input Amplifier (AMP) Mode.....	199
Figure 7-10: Analog Input Amplitude Modulation (AM) Mode .....	200
Figure 7-11: Analog Input ADD (Summation) mode.....	200
Figure 8-1: OUTP:ZERO Command Ramp and Dwell settings.....	236
Figure 8-2: Status Byte Logical Model .....	395
Figure 8-3: Standard Event Register (ESR) Model .....	396
Figure 8-4: SCPI Status Registers Model.....	398
Figure 9-1: PPST USB Drivers visible in Windows Device Manager .....	400
Figure 10-1: LXI Web Server Home Screen .....	402
Figure 10-2: ACCESS CONTROL Dialog Screen .....	404
Figure 10-3: Remote Access Control Request Dialog .....	405
Figure 10-4: Remote Access Control IP Filter screen.....	406
Figure 10-5: Waveform Edit defined using 4 data points.....	429
Figure 10-6: Waveform Edit defined using 16 data points.....	429
Figure 11-1: Voltage Calibration Equipment Setup – 1 or 3 Phase Mode – Phase A.....	472

---

Figure 11-2 Current Calibration Equipment Setup – 3 Phase Mode – Phase A.....	474
Figure 11-3: Current Calibration Equipment Setup – 1 Phase Mode .....	475

## 1 Contact Information

### AMERICA / CANADA

**Pacific Power Source**

2802 Kelvin Avenue, Suite 100

Irvine, CA 92614

USA

Phone: +1(949) 251-1800

Fax: +1 (949) 756-0756

Email: [support@pacificpower.com](mailto:support@pacificpower.com)

### EUROPE

**Pacific Power Source Europe, GmbH.**

Binzigstraße 21

D-77876 Kappelrodeck

Germany

Phone: +49(0)7842-99722-20

Fax: +49(0)7842-99722-29

Email: [info@pacificepower.eu](mailto:info@pacificepower.eu)

### CHINA

**PPST Shanghai Co. Ltd.**

4 floors , building 2, No. 2185 Lai Fang Road

Jiu Ting Town, Song Jiang District

Shanghai 201615

Phone: +86-21-6763-9223

Fax: +86-21-5763-8240

Email: [support@pacificepower.com](mailto:support@pacificepower.com)

Web: <http://pacificpower.com>

## 2 Safety & Warranty Information

### 2.1 Limited Warranty

Pacific Power Source, Inc. (PPS) warrants each unit to be free from defects in material and workmanship. For the period of two (2) years from the date of shipment to the purchaser, PPS will either repair or replace, at its sole discretion, any unit returned to the PPS factory in Irvine, California or one of its designated service facilities. It does not cover damage arising from misuse of the unit or attempted field modifications or repairs. This warranty specifically excludes damage to other equipment connected to this unit.

Upon notice from the purchaser within (30) days of shipment of units found to be defective in material or workmanship, PPS will pay all shipping charges for the repair or replacement. If notice is received more than thirty (30) days from shipment, all shipping charges shall be paid by the purchaser. Units returned on debit memos will not be accepted and will be returned without repair.

**This warranty is exclusive of all other warranties, expressed or implied.**

### 2.2 Service and Spare Parts Limited Warranty

PPS warrants repair work to be free from defects in material and workmanship for the period of ninety (90) days from the invoice date. This Service and Spare Parts Limited Warranty applies to replacement parts or to subassemblies only. All shipping and packaging charges are the sole responsibility of the buyer. PPS will not accept debit memos for returned power sources or for subassemblies. Debit memos will cause return of power sources or assemblies without repair.

**This warranty is exclusive of all other warranties, expressed or implied.**

### 2.3 Safety Information

This chapter contains important information you should read BEFORE attempting to install and power-up PPS Equipment. The information in this chapter is provided for use by experienced operators. Experienced operators understand the necessity of becoming familiar with, and then observing, life-critical safety and installation issues. Topics in this chapter include:

- Safety Notices
- Cautions
- Preparation for Installation
- Installation Instructions

Make sure to familiarize yourself with the **SAFETY SYMBOLS** shown on the next page. These symbols are used throughout this manual and relate to important safety information and issues affecting the end user or operator.



**SAFETY SYMBOLS**



**Direct current (DC)**



**Alternating current (AC)**



**Both direct and alternating current**



**Three-phase alternating current**



**Protective Earth (ground) terminal**



**On (Supply)**



**Off (Supply)**



**Fuse**



**Caution: Always consult this manual when you see this warning symbol marking in order to familiarize yourself with the nature of the potential hazard and actions to be taken to avoid them.**



**Caution, risk of electric shock**

## 2.4 Safety Notices

### SAFETY SUMMARY

The following general safety precautions must be observed during all phases of operation, service, and repair of this instrument. Failure to comply with these precautions or with specific warnings elsewhere in this manual violates safety standards of design, manufacture, and intended use of the instrument. Pacific Power Source assumes no liability for the customer's failure to comply with these requirements.



#### CAUTION: CLASS 1 INSTRUMENT

This product is a Safety Class 1 instrument (provided with a protective earth terminal). The protective features of this product may be impaired if it is used in a manner not specified in the operation instructions.



#### AVERTISSEMENT: APPAREIL CLASSE 1

Cet produit est un appareil Classe 1 (avec terre de protection). Les dispositifs de sécurité de ce produit peuvent être altérés si le produit est utilisé d'une manière non spécifiée dans le manuel d'utilisation.



#### CAUTION: ENVIRONMENTAL CONDITIONS

This instrument is intended for indoor use in an installation category II, pollution degree 2 environments only. It is designed to operate at a maximum relative humidity of 80% for temperatures up to 31 °C, decreasing linearly to 50 % relative humidity at 40 °C and at altitudes of up to 2000 meters. Refer to the specifications tables for the ac mains voltage requirements and ambient operating temperature range.



#### AVERTISSEMENT: CONDITIONS ENVIRONNEMENTALES

Cet appareil est destiné à une utilisation intérieure dans une installation de catégorie II, degré de pollution 2. Il est conçu pour fonctionner sous humidité relative maximale de 80%, pour des températures allant jusqu'à 31°C, diminuant linéairement jusqu'à 50% d'humidité relative à 40°C et à des altitudes allant jusqu'à 2000 m. Se reporter aux tableaux de spécifications pour les exigences en terme de tension secteur et plage de température ambiante de fonctionnement.

**CAUTION: USE COPPER CONDUCTOR WIRING ONLY**

Use only copper conductor (CU) wiring for all AC Input, AC Output and Ground Connections.

**ATTENTION: UTILISER UNIQUEMENT LE CÂBLAGE DU CONDUCTEUR EN CUIVRE**

Utilisez uniquement un câblage à conducteur en cuivre (CU) pour toutes les connexions d'entrée CA, de sortie CA et de mise à la terre.

**CAUTION: BEFORE APPLYING POWER**

Verify that the product AC input specifications noted on the model tag matches the available utility line voltage and frequency.

**ATTENTION: AVANT DE METTRE SOUS TENSION**

Vérifier que les spécifications de tension d'alimentation de l'équipement notées sur l'étiquette sont bien compatibles avec la tension et fréquence secteur disponibles.

**SAFETY NOTICE: GROUNDING**

This product is a Safety Class 1 instrument (provided with a protective earth terminal). To minimize shock hazard, the instrument chassis or cabinet must be connected to an electrical safety ground. The instrument must be connected to the AC power supply mains through a properly rated three phase power cable with protective earth (L1-L2-L3-E). Any interruption of the protective (grounding) conductor or disconnection of the protective earth terminal will cause a potential shock hazard that could result in personal injury.

This instrument may be equipped with a line filter to reduce electromagnetic interference and must be properly grounded to minimize electric shock hazard. Operation at line voltages or frequencies in excess of those stated on the model type plate may cause leakage currents in excess of 5.0 mA peak.



### REGLE DE SECURITE: MISE A LA TERRE

Ce produit est un équipement de Classe 1 (muni d'une borne de mise à la terre). Pour minimiser le risque de choc électrique, le châssis de l'appareil ou de l'armoire/rack doit impérativement être relié à une terre de sécurité électrique. L'appareil doit être branché sur le secteur d'alimentation électrique à courant alternatif par un câble d'alimentation triphasé approprié avec terre de protection (L1-L2-L3-PE). Toute interruption de la mise à la terre de protection ou de déconnexion de la borne de terre causera un risque de choc électrique qui pourrait entraîner des blessures.

Cet appareil peut être équipé d'un filtre secteur pour réduire les interférences électromagnétiques et doit être correctement mis à la terre afin de minimiser le risque de choc électrique. Le fonctionnement sous tensions et fréquences supérieures à celles indiquées sur l'étiquette peut provoquer des courants de fuite de plus de 5,0 mA peak.

**CAUTION: DO NOT OPERATE IN AN EXPLOSIVE ATMOSPHERE**

Do not operate the instrument in the presence of flammable gases or fumes.

**AVERTISSEMENT: NE PAS UTILISER SOUS ATMOSPHERE  
EXPLOSIVE**

Ne pas faire fonctionner l'appareil en présence de gaz ou vapeurs inflammables.

**CAUTION: KEEP AWAY FROM LIVE CIRCUITS**

Operating personnel must not remove instrument covers. Component replacement and internal adjustments must be made by qualified service personnel. Do not replace components with power cable connected. Under certain conditions, dangerous voltages may exist even with the power cable removed. This includes the AC Input terminals which may have residual voltage due to internal charged capacitors that have no discharge path. To avoid injuries, always disconnect power, discharge circuits and remove external voltage sources before touching components.

**AVERTISSEMENT: TENIR A L'ECART DE CIRCUITS SOUS TENSION**

Les utilisateurs ne doivent pas retirer les capots de l'appareil. Le remplacement des composants et les ajustements internes doivent être et ne peuvent être effectués que par un personnel qualifié. Ne pas remplacer les composants avec câble d'alimentation connecté sur le secteur. Sous certaines conditions, des tensions dangereuses peuvent exister même avec le câble d'alimentation retiré. Ceci inclut les bornes d'entrée CA qui peuvent avoir une tension résiduelle due aux condensateurs chargés internes. Pour éviter les blessures, toujours débrancher le câble d'alimentation, décharger les circuits électriques et débrancher les sources de tension externes avant de toucher les composants.

**CAUTION: DO NOT SUBSTITUTE PARTS OR MODIFY INSTRUMENT**

Because of the danger of introducing additional hazards, do not install substitute parts or perform any unauthorized modification to the instrument. Return the instrument to a Pacific Power Source Sales and Service Office for service and repair to ensure that safety features are maintained.

Instruments that appear damaged or defective should be made inoperative and secured against unintended operation until they can be repaired by qualified service personnel.

**AVERTISSEMENT: NE PAS REMPLACER DE PIÈCES ET DE COMPOSANTS – NE PAS MODIFIER L'ÉQUIPEMENT**

En raison d'introduction de dangers supplémentaires, ne pas installer des pièces de rechange et ne pas effectuer de modification de l'équipement non autorisés. Retourner l'appareil à un bureau de ventes et services Pacific Power Source pour le service et la réparation afin d'assurer le maintien des caractéristiques de sécurité. Les appareils qui semblent endommagés ou défectueux doivent être rendus inopérants et protégés contre le fonctionnement involontaire jusqu'à ce qu'ils puissent être réparés par un personnel qualifié.

**CAUTION: INSTRUMENT LOCATION**

Do not position this instrument in such a way as to block easy access to any mains disconnect device or in any way that makes it difficult to operate the mains disconnect device.

**ATTENTION: EMBLACEMENT DE L'APPAREIL**

Ne pas placer cet appareil de manière à bloquer l'accès facile à tout débranchement du réseau électrique ou d'une façon qui rende difficile l'opération de débranchement du réseau électrique.

## 3 Product Overview

This chapter provides an overview of the PPS LSX Series® programmable power sources. It introduces the reader to general operating characteristics of these power supplies.

### 3.1 General Description

The Pacific Power Source (PPS) LSX Series® power source is designed to provide accurate, stable and clean AC power to a unit under test.

This series of programmable AC power sources features models with power ratings from 1500 VA to 6000 VA. All systems are designed to fit into a standard 19-inch rack. These systems are suitable for use as frequency changers as well as sophisticated test power generators.

All systems are configured with an advanced high performance controller that offers full programmability of the AC power source. This controller allows control of voltage and frequency and also allows the user to simulate virtually any transient (including sub-cycle waveform disturbance) required for testing today's modern electronic equipment.

The LSX controller is also equipped with a high performance single or three phase power analyzer with deep acquisition memory for measurement and waveform capture of output parameters.

The standard output voltage range for most of the LSX-Series is 0-135 Vac L-N. Additionally, Models 120LSX and 320LSX can operate from 0 to 150 Vac L-N.

Optional output transformers are available to provide higher output voltages. Voltage ratios up to 2.5:1 are readily available. Other transformer ratios are available by special order.

The PPS LSX Series® power supply can be operated from the front panel (manual mode) or using RS232, USB, LAN (Ethernet) or GPIB remote control.

### 3.2 Available LSX Models

Model 105LSX - 500 VA, capable of 1 or 2 Phase operation. Single-phase output voltage range is 0-135 Vac L-N. Output voltage in two Phase Mode is 0-270 Vac L-L. An internal output transformer option is available for higher voltages.

1. Model 115LSX - 1500 VA, capable of 1 or 2 Phase operation. Single-phase output voltage range is 0-132 Vac L-N. Internal output transformer option available for higher voltages.
2. Model 120LSX – 1200 VA, capable of 1 or 2 Phase operation. Single-phase output voltage range is 0-150 Vac L-N. Output voltage in 2 Phase Mode is 0-300 Vac L-L. Additional ranges available with custom external transformer configurations.
3. Model 140LSX – 4.0 KVA, capable of 1 or 2 Phase operation. Single-phase output voltage range is 0-135 Vac L-N. Output voltage in 2 Phase Mode is 0-270 Vac L-L. External Magnetics Module available for higher output voltage ranges.

4. Model 160LSX - 6.0 kVA, capable of 1 or 2 Phase operation. Single-phase output voltage range is 0-135 Vac L-N. Output voltage in 2 Phase Mode is 0-270 Vac L-L. External Magnetics Module available for higher output voltage ranges.
5. Model 315LSX - 1500 VA, capable of 1, 2, or 3 Phase operation. Single and three phase modes provide 1500 VA of power with 0-132 Vac L-N output voltage range. 2 Phase Mode provides 1000 VA of power with 0-264 Vac L-L output voltage. Internal output transformer option available for higher voltages.
6. Model 320LSX – 1200 VA, capable of 1, 2, or 3 Phase operation. Single and three phase modes provide 1.2kVA of power with 0-150 Vac L-N output voltage range. 2 Phase Mode provides 1333VA of power with 0-300 Vac L-L output voltage. Additional ranges available with custom external transformer configurations.
7. Model 345LSX - 4.5 kVA, capable of 1, 2, or 3 Phase operation. Single and three phase modes provide 4.5kVA of power with 0-135 Vac L-N output voltage range. 2 Phase Mode provides 3.0kVA of power with 0-270 Vac L-L output voltage. External Magnetics Module available for higher output voltage ranges.
8. Model 360LSX - 6.0 kVA, capable of 1, 2, or 3 Phase operation. Single and three phase modes provide 6.0kVA of power with 0-135 Vac L-N output voltage range. 2 Phase Mode provides 4.0kVA of power with 0-270 Vac L-L output voltage. External Magnetics Module available for higher output voltage ranges.

External voltage sense is provided on all systems. Systems configured with the programmable controller also feature Continuous Self Calibration (CSC).

Output voltage and current metering is provided on all systems. Specifications of the metering functions vary by controller type. Refer to the UPC-Series Operation Manual, as appropriate, for details relative to the metering functions.

The performance of the LSX Series® power source models is detailed in section 4, “Technical Specifications”. Maximum voltage, current and power capability depends on the specific model. This manual covers standard LSX Series® models. Modified units are generally shipped with a manual addendum as a supplement to this manual. The manual addendum covers specific modifications from the standard model(s).

### 3.3 M Version Models (LSXM)

The LSX Series can be ordered with the M modification which removed a number of advanced features from the power source for applications that don't require these advanced features and or measurements. The LSXM models have the same technical specifications but a number of output functions and advanced measurements have been removed. A summary comparison between the standard LSX Series and the LSXM versions is shown in the table below.

Note that this manual covers both versions as the LSXM is a subset of the LSX. Refer to the table below to determine what sections of this manual do or do not apply to the LSXM models.



FEATURES	LSX	LSXM
Output Waveforms	Sine, Square, Triangle, Clipped (THD), Arbitrary	Sinewave only
Phase Angles for phase B, C with respect to phase A	Programmable	Fixed: 120°,240° or 240°,120°
Transient Programming	yes	no
Programmable V,F slew rate	yes	yes
Programmable Settings	yes	yes
Measurements (scalar)	yes	yes
Harmonic Measurements	yes	no
Waveform Capture	yes	no
Programmable output Impedance (Prog-Z)	yes	no
Digital control interfaces	yes	yes

Table 3-1: Feature comparison between LSX and LSXM Models

### 3.4 Product Features

The following key characteristics apply to all LSX Series® models;

- Programmable electronic power source.
- AC output mode
- Single or Three / Split phase output models available.
- Fully remote control of all settings and metering read back.
- Over voltage, over current and over power protection.
- External voltage sense.
- Auxiliary I/O – Analog and Digital.
- Digital Interfaces for Remote Control

### 3.5 Controller Description

The LSX Series® power supplies use an advanced command processor that communicates with the internal power stages using internal communication buses and with the outside world through a variety of interfaces. One of these interfaces is the front panel keyboard and LCD display, which supports manual operation of the AC power source.

The command processor handles all user inputs as well as any analog or digital input provided to the unit. All power stages are operated autonomously and take input from the main command processor. For larger power configurations consisting for multiple chassis, the master unit command processor communicates to all chassis that are connected on the master/auxiliary interconnect bus.

### 3.6 Measurement Read-back

The voltage, frequency and current limit settings of the AC power source can be set from the front panel or over any of the available digital remote control interfaces. During operation, the AC source output voltage, frequency, current and power can be read back for each of the available output phases.

### 3.7 Accessories Included (Ship Kit)

The following accessories are included with each LSX Series® AC power source. If one or more of these is missing upon incoming inspection of the product, please contact Pacific Power Source customer service.

Item	Quantity
Operation Manual in PDF Format	Available from PPS website
P20 Loop-back Plug	1 per unit
Certificate of Conformance	1

*Table 3-2: Included Accessories*

## 4 Technical Specifications

Technical specifications shown here apply at an ambient temperature of 25° C ± 5° C.

### 4.1 Available Models – Power & Voltage Ranges

LSX Series models are available with either single-phase output configuration or three-phase output configuration. The first digit of the model number identifies the output configuration:

**1xxLSX** = Single-phase

**3xxLSX** = Three-phase

#### 4.1.1 Single Phase Models – Direct Coupled Output

MODEL	Rated Power (VA) <sup>1</sup>	Output Form <sup>2</sup>	Output Voltage Max <sup>3</sup> (I-n/I-l)	Output Current <sup>4</sup> (A <sub>rms</sub> )	Input Power <sup>5</sup>
<b>115LSX</b>	1500	1	0-132	16	1∅
<b>120LSX</b>	2000	1/2	0-150/300	20/14	1∅
<b>140LSX</b>	4000	1/2	0-135/270	32/16	3∅
<b>160LSX</b>	6000	1/2	0-132/264	48/16	3∅

#### 4.1.2 Single Phase Models – Transformer Output

MODEL	Rated Power (VA) <sup>1</sup>	Output Form <sup>2</sup>	Output Voltage Max <sup>3</sup> (I-n/I-l)				Output Current <sup>4</sup> (A <sub>rms</sub> )				Input Power <sup>5</sup>
			Direct	Transformer			Direct	Transformer			
				Ratio 1.5:1	Ratio 2.0:1	Ratio 2.5:1		Ratio 1.5:1	Ratio 2.0:1	Ratio 2.5:1	
<b>115LSXT</b>	1500	1	0-132	0-198	0-264	0-330	16	10.7	8	6.4	1∅
<b>140LSXT</b>	4000	1/2	0-135/270	0-202/404	0-270/540	0-338/600	32/16	21.3/10.7	16/8	12.8/6.4	3∅
<b>160LSXT</b>	6000	1/2	0-132/264	0-198/396	0-264/528	0-330/600	48/16	32/10.6	24/8	19.2/6.4	3∅

1. Rated output power is based on a combination of output voltage, current and load power factor. Values stated represent the rated capabilities of a given model. Consult factory for assistance in determining specific unit capabilities as they might apply to your application.
2. All single-phase output units (Model 115 ASX excepted) are operable with dual voltage ranges as listed. Output voltage ranges and 1∅/2∅ conversions are selected by front panel or bus commands.
3. Output voltage ranges listed are for standard units. VMAX is output voltage with nominal input and full rated load applied. Other voltage ranges are available with the output magnetics options below.
4. Available current will vary with output voltage and power factor.
5. Input power frequency is 47–63 Hz. Single phase input: 100, 110, 120, 208, 220, 230 and 240 VAC ±10%. Three phase input: 208, 220, 240, 380, 400 and 416 VAC ± 10%.
6. Single phase and 400 Hz input options may be available. Consult Factory.

#### 4.1.3 Three Phase Models – Direct Coupled Output

MODEL	Rated Power (VA) <sup>1</sup>	Output Form <sup>2</sup>	Output Voltage Max <sup>3</sup> (I-n/I-I)	Output Current <sup>4</sup> (A <sub>rms</sub> )	Input Power <sup>5</sup>
315LSX	1200	1/2 3	0-132/264 0-132/228	12/6 4/∅	1∅
320LSX	2000	1/2 3	0-150/300 0-150/260	20/12 7/∅	1∅
345LSX	4500	1/2 3	0-135/270 0-135/234	36/12 12/∅	3∅
360LSX	6000	1/2 3	0-132/264 0-132/228	48/16 16/∅	3∅

#### 4.1.4 Three Phase Models – Transformer Output

MODEL	Rated Power (VA) <sup>1</sup>	Output Form <sup>2</sup>	Output Voltage Max <sup>3</sup> (I-n/I-I)				Output Current <sup>4</sup> (A <sub>rms</sub> )				Input Power <sup>5</sup>
			Direct	Transformer			Direct	Transformer			
				Ratio 1.5:1	Ratio 2.0:1	Ratio 2.5:1		Ratio 1.5:1	Ratio 2.0:1	Ratio 2.5:1	
345LSXT	4500	1/2 3	0-135/270 0-135/234	0-202/404 0-202/350	0-270/540 0-270/468	0-338/600 0-338/585	36/12 12/∅	24/8 8/∅	18/6 6/∅	14.4/4.8 4.8/∅	3∅
360LSXT	6000	1/2 3	0-132/264 0-132/228	0-198/396 0-198/343	0-264/528 0-264/457	0-330/600 0-330/572	48/16 16/∅	32/10.7 10.7/∅	24/8 8/∅	19.2/6.4 6.4/∅	3∅

- Rated output power is based on a combination of output voltage, current and load power factor. Values stated represent the rated capabilities of a given model. Consult factory for assistance in determining specific unit capabilities as they might apply to your application.
- All three phase units are operable as single phase with dual voltage range capability or as three-phase. Output voltage ranges and 1∅/3∅ conversions are selected by front panel or bus commands.
- Output voltage ranges listed are for standard units. VMAX is output voltage with nominal input and full rated load applied. Other voltage ranges are available with the output magnetics options below.
- Current ratings at 125Vrms output. Current may vary with power factor.
- Input power frequency is 47-63 Hz. Single phase input: 100, 110, 120, 208, 200, 220, 230 and 240 VAC ±10%. Three phase input: 208, 220, 240, 380, 400 and 416 VAC ±10%. (480V input or 400 Hz frequency input available as a cost option on most ASX models.
- Single phase and 400 Hz input options may be available. Consult Factory.

## 4.2 AC Output Current Ratings by Model

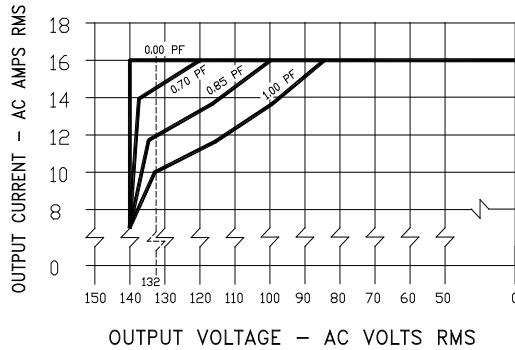
The full-rated output current of the LSX-Series Power Source is listed below by model number. Current is stated for output voltage set to 125 Vac L-N. Refer to the Power Factor Rating charts on subsequent pages for maximum current at reduced voltage settings. Output current ratings are scaled appropriately by the selected transformer ratio when using transformer-coupled outputs.

MODEL	Single Phase Mode		Split Phase Mode		Three Phase Mode	
	lout, rms	lout, pk	lout, rms	lout, pk	lout, rms	lout, pk
115LSX	16 A	35 A			-	-
120LSX	20 A	90 A	14 A	45 A	-	-
140LSX	32 A	90 A	16 A	45 A	-	-
160LSX	48 A	120 A	16 A	45 A	-	-
315LSX	12 A	69 A	6 A	23 A	4 A	23 A
320LSX	20 A	69 A	12 A	23 A	7 A	23 A
345LSX	36 A	100 A	12 A	40 A	12 A	40 A
360LSX	48 A	120 A	16 A	45 A	16 A	45 A

Table 4-1: AC Output RMS & Peak Current Rating by Model

### 4.2.1 Output Rating Charts Single-Phase Models

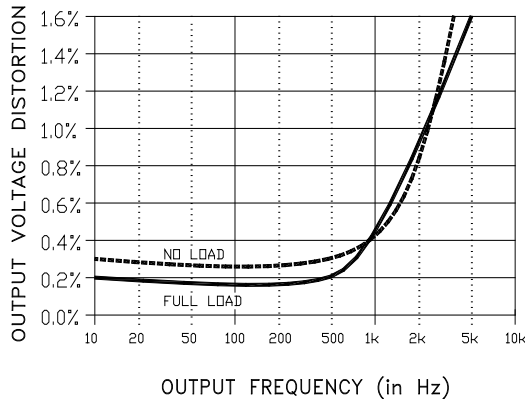
#### 115LSX Model



#### RATING CURVE

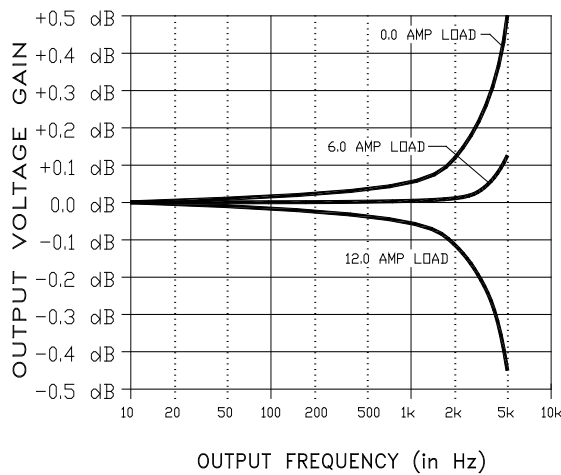
Rated continuous load current as a function of power factor and output voltage—Nominal input line.

Short term overloads to 20 Amps are permitted. Operating time before thermal shutdown or circuit breaker trip varies from seconds to several minutes depending on line and temperature conditions.



#### TYPICAL OUTPUT DISTORTION

Output Voltage THD vs. Frequency

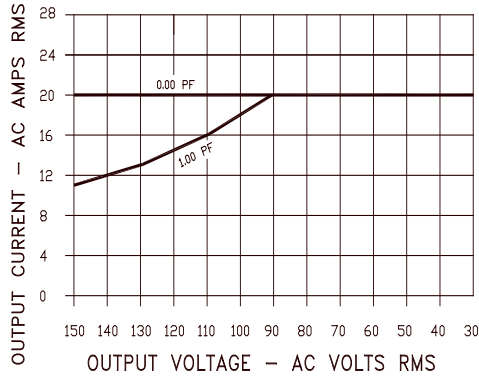


#### FREQUENCY RESPONSE

Output Voltage Gain vs. Frequency  
Measured at 120 Vac, with resistive load

Figure 4-1: 105LSX Rating Charts

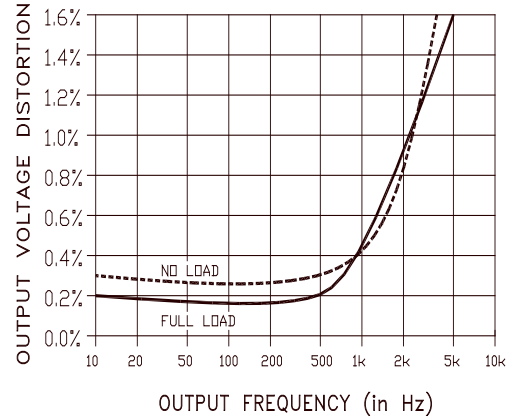
**120LSX Model**



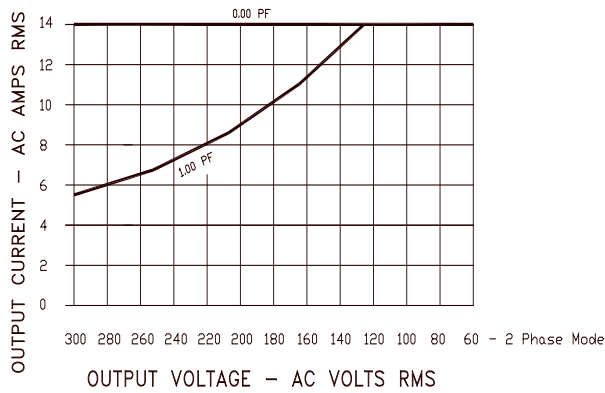
**RATING CURVE  
1 PHASE MODE**

Rated continuous load current as a function of Power Factor and Output Voltage – Nominal Input Line.

Short term overloads to 30 Amps are permitted. Operating time before thermal shutdown or circuit breaker trip varies from seconds to several minutes depending upon line and temperature conditions.



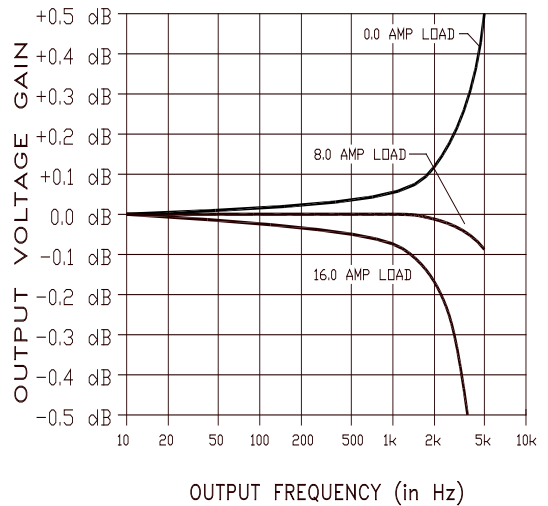
**TYPICAL OUTPUT DISTORTION  
Output Voltage THD vs. Frequency**



**RATING CURVE  
2 PHASE MODE**

Rated continuous load current as a function of Power Factor and Output Voltage – Nominal Input Line.

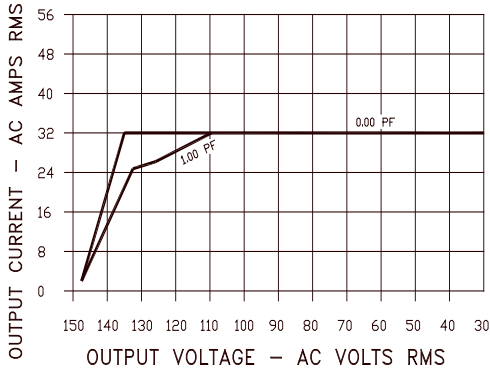
Short term overloads to 15 Amps are permitted. Operating time before thermal shutdown or circuit breaker trip varies from seconds to several minutes depending upon line and temperature conditions.



**FREQUENCY RESPONSE  
Output Voltage Gain vs. Frequency  
Measured at 120 VAC, with resistive load**

Figure 4-2: 120LSX Rating Charts

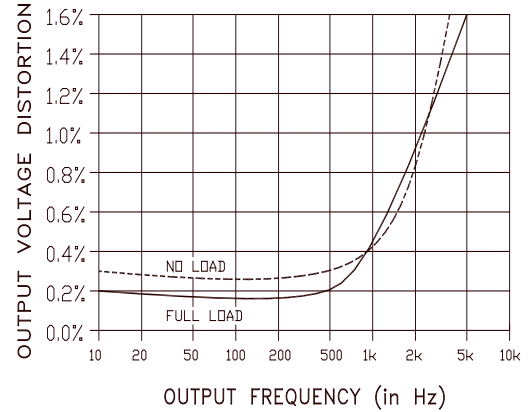
**140LSX Model**



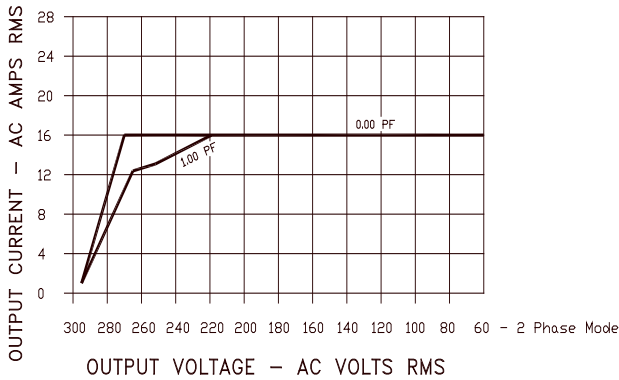
**RATING CURVE  
1 PHASE MODE**

Rated continuous load current as a function of Power Factor and Output Voltage - Nominal Input Line.

Short term overloads to 40 Amps are permitted. Operating time before thermal shutdown or circuit breaker trip varies from seconds to several minutes depending upon line and temperature conditions.



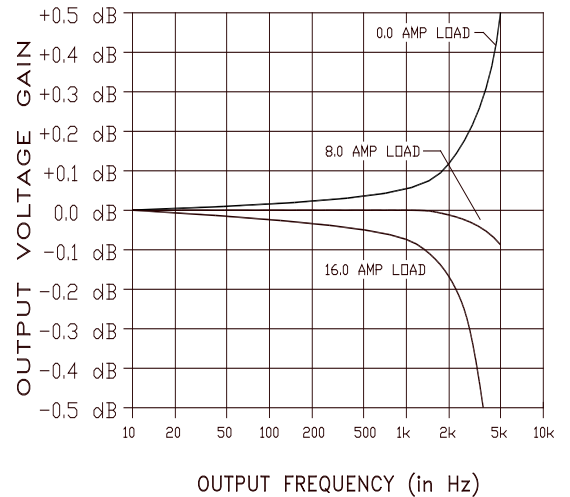
**TYPICAL OUTPUT DISTORTION**  
Output Voltage THD vs. Frequency



**RATING CURVE  
2 PHASE MODE**

Rated continuous load current as a function of Power Factor and Output Voltage - Nominal Input Line.

Short term overloads to 20 Amps are permitted. Operating time before thermal shutdown or circuit breaker trip varies from seconds to several minutes depending upon line and temperature conditions.

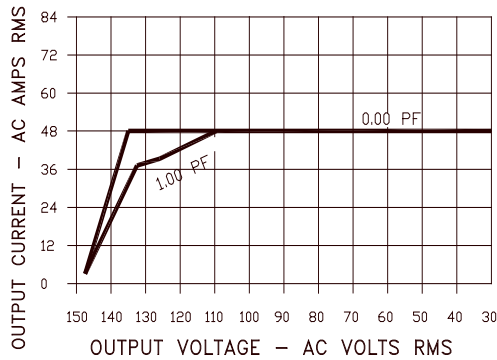


**FREQUENCY RESPONSE**  
Output Voltage Gain vs. Frequency  
Measured at 120 VAC, with resistive load

Figure 4-3: 140LSX Rating Charts



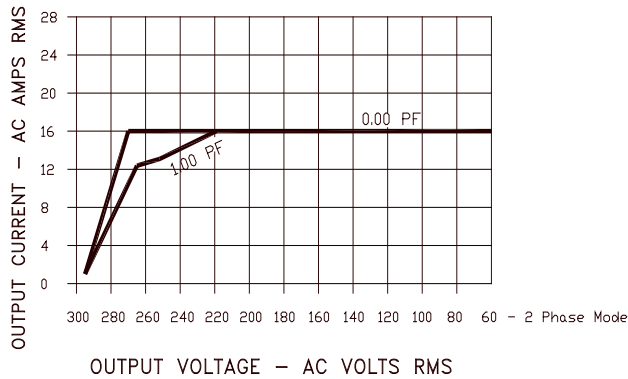
**160LSX Model**



**RATING CURVE**  
**1 PHASE MODE**

Rated continuous load current as a function of Power Factor and Output Voltage - Nominal Input Line.

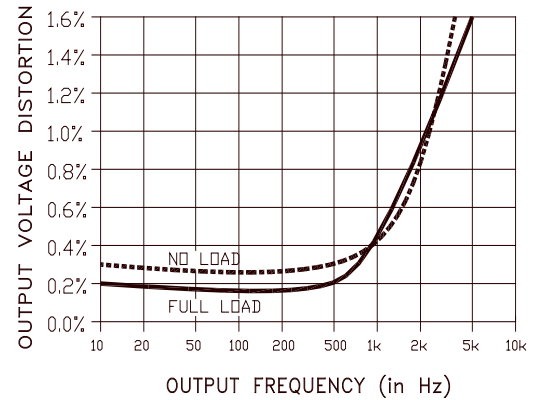
Short term overloads to 60 Amps are permitted. Operating time before thermal shutdown or circuit breaker trip varies from seconds to several minutes depending upon line and temperature conditions.



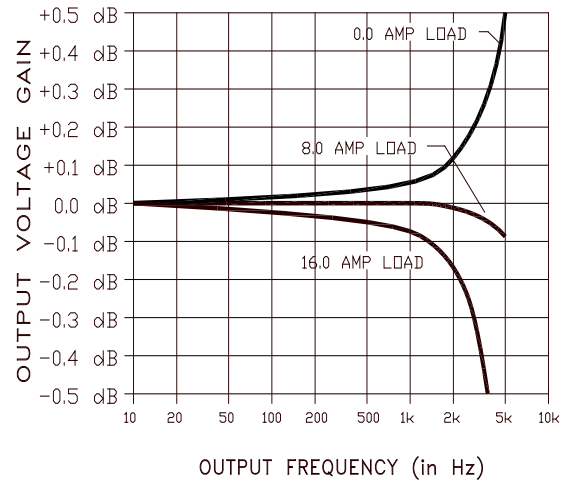
**RATING CURVE**  
**2 PHASE MODES**

Rated continuous load current as a function of Power Factor and Output Voltage - Nominal Input Line.

Short term overloads to 20 Amps are permitted. Operating time before thermal shutdown or circuit breaker trip varies from seconds to several minutes depending upon line and temperature conditions.



**TYPICAL OUTPUT DISTORTION**  
Output Voltage THD vs. Frequency

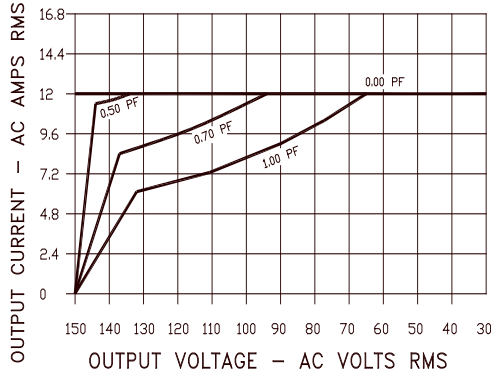


**FREQUENCY RESPONSE**  
Output Voltage Gain vs. Frequency  
Measured at 120 VAC, with resistive load

Figure 4-4: 160LSX Rating Charts

4.2.2 Output Rating Charts Three-Phase Models

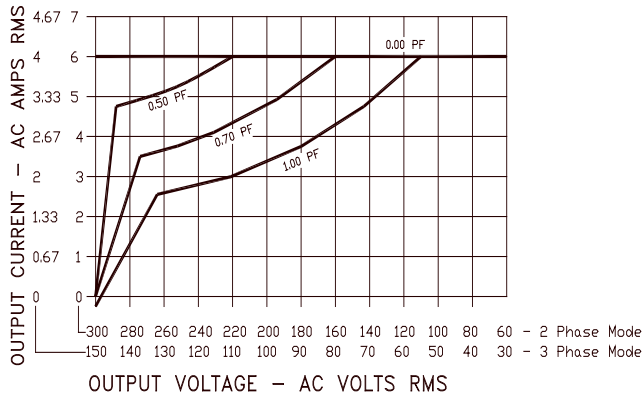
**315LSX**



**RATING CURVE**  
**1 PHASE MODE**

Rated continuous load current as a function of Power Factor and Output Voltage - Nominal Input Line.

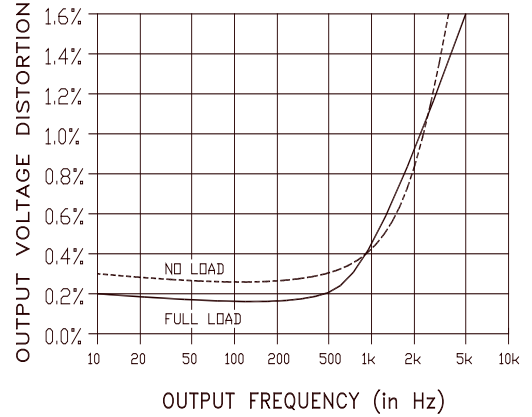
Short term overloads to 20 Amps are permitted. Operating time before thermal shutdown or circuit breaker trip varies from seconds to several minutes depending upon line and temperature conditions.



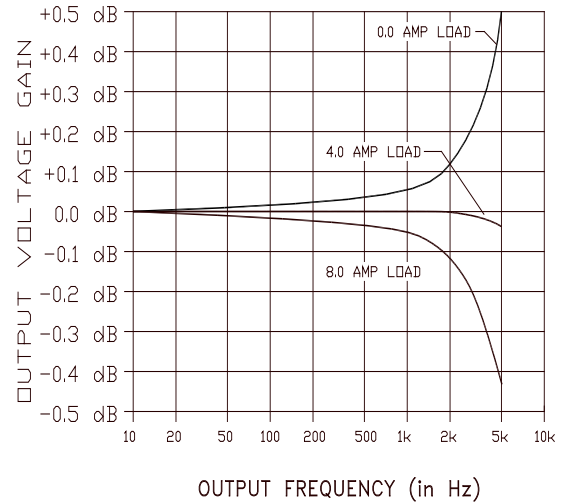
**RATING CURVE**  
**2 & 3 PHASE MODES**

Rated continuous load current as a function of Power Factor and Output Voltage - Nominal Input Line.

Short term overloads to 12 Amps are permitted. Operating time before thermal shutdown or circuit breaker trip varies from seconds to several minutes depending upon line and temperature conditions.



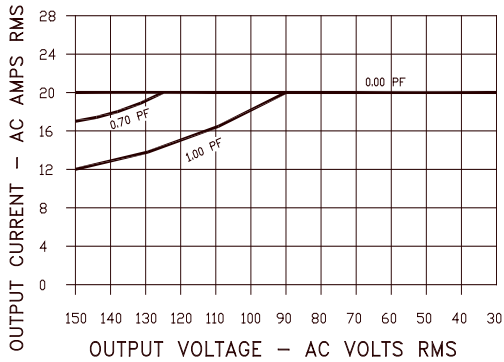
**TYPICAL OUTPUT DISTORTION**  
Output Voltage THD vs. Frequency



**FREQUENCY RESPONSE**  
Output Voltage Gain vs. Frequency  
Measured at 120 VAC, with resistive load

Figure 4-5: 315LSX Rating Charts

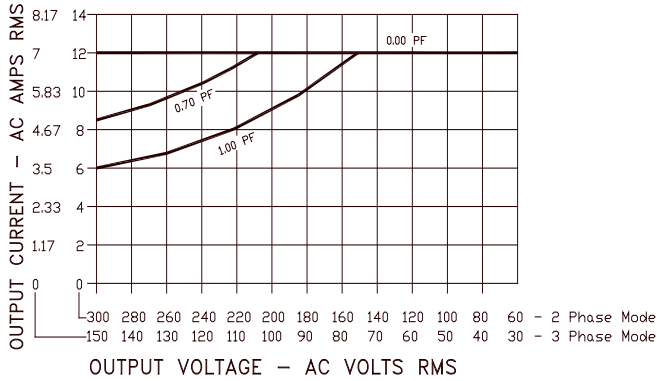
**320LSX**



**RATING CURVE  
1 PHASE MODE**

Rated continuous load current as a function of Power Factor and Output Voltage - Nominal Input Line.

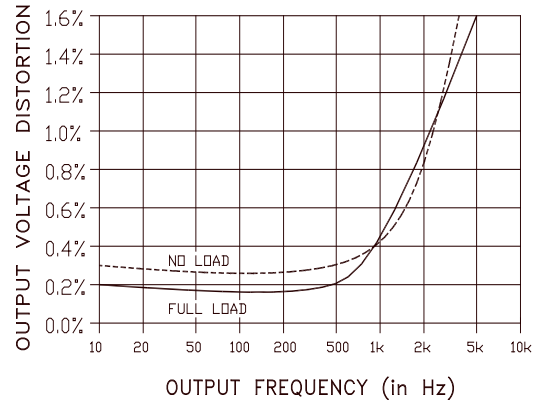
Short term overloads to 30 Amps are permitted. Operating time before thermal shutdown or circuit breaker trip varies from seconds to several minutes depending upon line and temperature conditions.



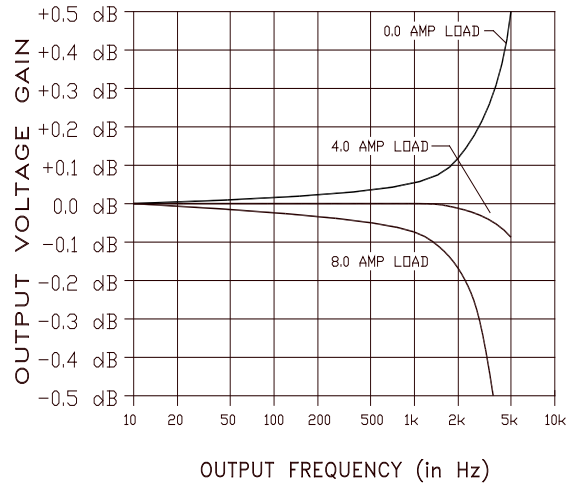
**RATING CURVE  
2 & 3 PHASE MODES**

Rated continuous load current as a function of Power Factor and Output Voltage - Nominal Input Line.

Short term overloads to 15 Amps are permitted. Operating time before thermal shutdown or circuit breaker trip varies from seconds to several minutes depending upon line and temperature conditions.



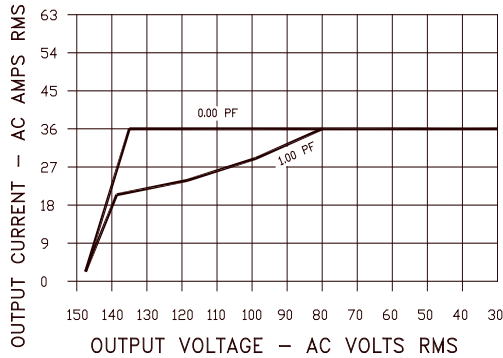
**TYPICAL OUTPUT DISTORTION  
Output Voltage THD vs. Frequency**



**FREQUENCY RESPONSE  
Output Voltage Gain vs. Frequency  
Measured at 120 VAC, with resistive load**

Figure 4-6: 320LSX Rating Charts

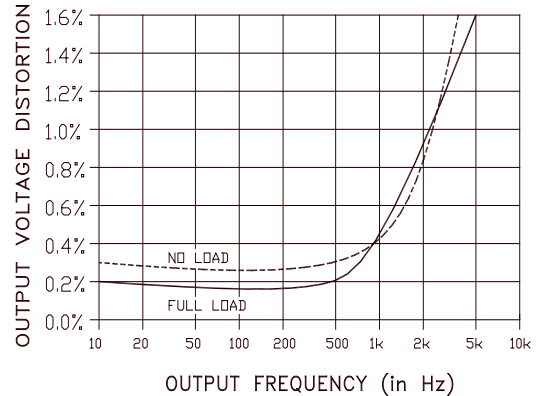
**345LSX**



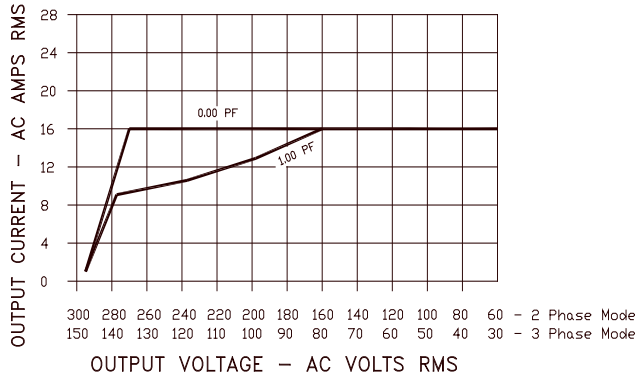
**RATING CURVE**  
**1 PHASE MODE**

Rated continuous load current as a function of Power Factor and Output Voltage – Nominal Input Line.

Short term overloads to 60 Amps are permitted. Operating time before thermal shutdown or circuit breaker trip varies from seconds to several minutes depending upon line and temperature conditions.



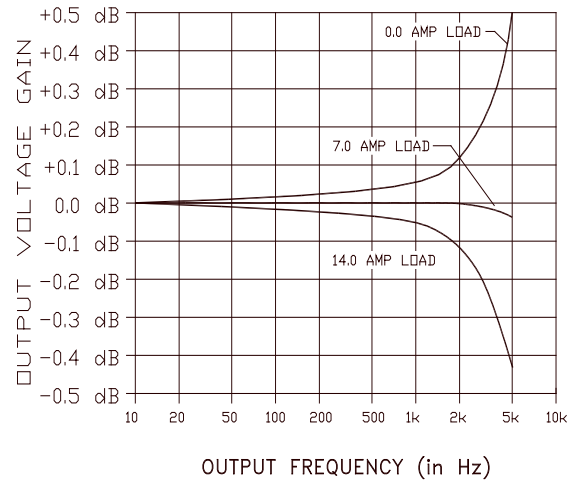
**TYPICAL OUTPUT DISTORTION**  
Output Voltage THD vs. Frequency



**RATING CURVE**  
**2 & 3 PHASE MODES**

Rated continuous load current as a function of Power Factor and Output Voltage – Nominal Input Line.

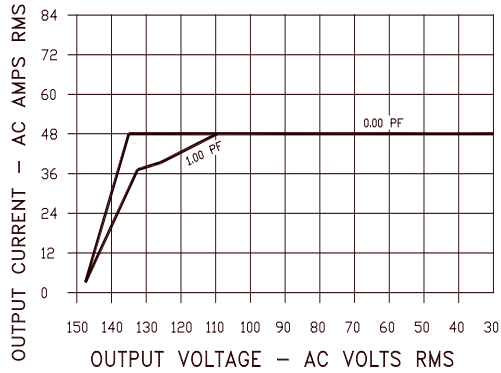
Short term overloads to 20 Amps are permitted. Operating time before thermal shutdown or circuit breaker trip varies from seconds to several minutes depending upon line and temperature conditions.



**FREQUENCY RESPONSE**  
Output Voltage Gain vs. Frequency  
Measured at 120 VAC, with resistive load

Figure 4-7: 345LSX Rating Charts

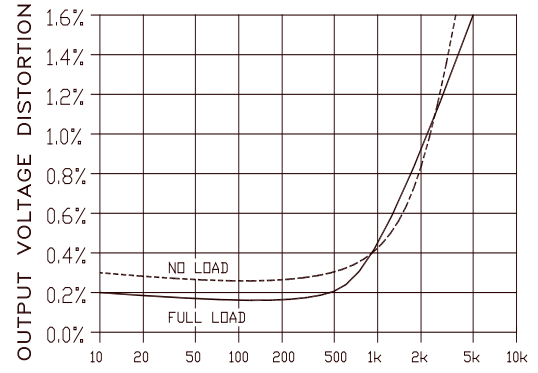
### 360LSX



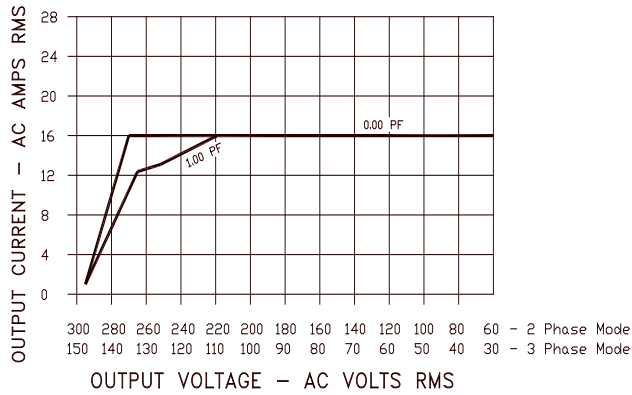
#### RATING CURVE 1 PHASE MODE

Rated continuous load current as a function of Power Factor and Output Voltage - Nominal Input Line.

Short term overloads to 60 Amps are permitted. Operating time before thermal shutdown or circuit breaker trip varies from seconds to several minutes depending upon line and temperature conditions.



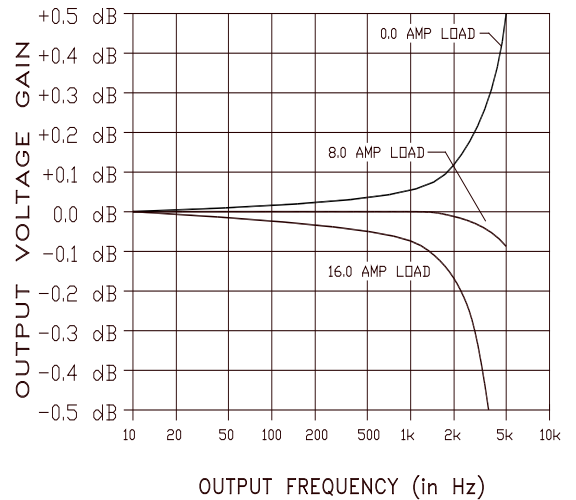
#### TYPICAL OUTPUT DISTORTION Output Voltage THD vs. Frequency



#### RATING CURVE 2 & 3 PHASE MODES

Rated continuous load current as a function of Power Factor and Output Voltage - Nominal Input Line.

Short term overloads to 20 Amps are permitted. Operating time before thermal shutdown or circuit breaker trip varies from seconds to several minutes depending upon line and temperature conditions.



#### FREQUENCY RESPONSE Output Voltage Gain vs. Frequency Measured at 120 VAC, with resistive load

Figure 4-8: 360LSX Rating Charts


### 4.3 Overload Operation

The LSX-Series Power Source will deliver up to 125% of rated RMS output current at 25°C ambient room temperature, nominal through 10% high input line voltage, and at a power factor of 0.8. Elevated ambient temperatures, low input line voltage, or power factors between 0.8 and 1.0 will increase the internal dissipation of the power source and can cause overload shutdown due to over-temperature conditions. Length of time to reach over-temperature varies with the models and the parameters shown in Table 4-1 on page 29.

### 4.4 AC Output – All Models

OUTPUT		SPECIFICATION	
<b>Power</b>			
	Output	See Model Tables Section 4.1	
	Power Factor	See Model Tables Section 4.2	
<b>Voltage</b>			
	Mode	AC	
	Direct Coupled Range	See Model Tables Section 4.1	
	T-Option Ranges	Turns ratios: 1:1.5, 1:2.0, 1:2.5	
	Programming Resolution	0.01 V	
	Accuracy	±0.25% F.S. / ±0.1% in CSC mode	
	Waveforms (200 Max.)	Sine <sup>1</sup> , Square, Triangle, Clipped (THD), Arbitrary	
	DC Offset	< 20 mV	
	Harmonic Distortion (V <sub>thd</sub> ) (full, resistive load)	<b>Form 1</b>	<b>Form 3</b>
	3U Models 15 - 200 Hz	< ± 0.25%	< ± 0.25%
	200 - 1200 Hz <sup>2</sup>	< f x 0.7% + 0.36%	< f x 0.7% + 0.11%
	120/320LSX Models 15 - 200 Hz	< ± 0.25%	< ± 0.25%
	200 - 1200 Hz <sup>2</sup>	< f x 0.7% + 0.36%	< f x 0.7% + 0.36%
	5U Models 15 - 200 Hz	< ± 0.25%	< ± 0.25%
	200 - 1200 Hz <sup>2</sup>	< f x 1.4% + 0.22%	< f x 1.4% + 0.03%
	Output Noise	< 50 mVrms	
	DC Offset	< 5 mVdc	
	Load Regulation Direct Coupled	<b>Form 1</b>	<b>Form 3</b>
	3U Models 15 - 200 Hz	< ± 0.25%	< ± 0.25%
	200 - 1200 Hz <sup>2</sup>	< f x 0.7% + 0.11%	< ± 0.5%
	120/320LSX Models 15 - 200 Hz	< ± 0.25%	< ± 0.25%
	200 - 1200 Hz <sup>2</sup>	< ± 0.6%	< ± 0.5%
	5U Models 15 - 200 Hz	< ± 0.25%	< ± 0.25%
	200 - 1200 Hz <sup>2</sup>	< f x 2.5% - 0.25%	< f x 1.5% - 0.05%
	Transformer Coupled Load Regulation	Direct Coupled: ± 0.0% (CSC Mode) Transformer Coupled: ± 0.0% (CSC Mode) TR 1.5:1 2% CSC Mode off	

<sup>1</sup> Sine wave only on LSXM Models  
<sup>2</sup> Frequency "f" in formulas is in kHz.

OUTPUT		SPECIFICATION
		TR 2.0:1 4% CSC Mode off TR 2.5:1 5% CSC Mode off
Line Regulation		< 0.1% for 10% Line Change
Voltage Sense		External Sense, max. voltage drop 5% F.S.
Voltage Response Time		5 µsec typical to a step load change.
<b>Isolation</b>		
Output Neutral to Chassis		150 Vac Max (Direct Coupled Mode)
Output Line to Chassis		338 Vac Max (Direct Coupled Mode)
 Note		In Transformer Coupled mode, Neutral must be connected to Chassis.
<b>Frequency Range</b>		
Direct Coupled Range		15.00 – 1200.0 Hz
Transformer Coupled Range		45.00 – 1200.0 Hz
Programming Resolution		0.01 Hz <i>(see section 4.4.1 for E versions)</i>
Accuracy		± 0.005% / 50 ppm
<b>Bandwidth</b>		
Full Power		15 to 400 Hz ± 0.10 dB [± 1%] 400 to 1200 Hz ± 0.25 dB [± 3%]
Small Signal		5 to 2500 Hz ± 0.50 dB [± 6%] Rated at 10% of full-scale output voltage
<b>Load Transient Response</b>		Output load transient response for a 10-90% load induced step transient is approximately 60 µsec
<b>Current</b>		
Range		See Model Tables Section 4.2
Programming Resolution		0.01 Arms
Accuracy		± (0.5% + f (kHz) * 0.5%) F.S.
Current Protection (CP) Modes		Constant Current (CC) or Output Trip (CV)
Current Overload Mode		Allows 125% of max. RMS current for up to 1 min
<b>Phase Angle (In 3 and 2 Phase Mode)</b>		
Programmable Phase <sup>2</sup> (B, C)		0 - 359.9°
Resolution		0.1°
Accuracy		±0.35° / ±0.1° in Phase Reg. Mode
<b>Programmable Impedance<sup>3</sup> (Real-Time Mode)</b>		
Resistance (R)		See Table 4-2
Inductance (L)		
<b>Programmable Impedance (RMS Mode)</b>		
Resistance (R)		See Table 4-2
Inductance (L)		

<sup>2</sup> Fixed 120°, 240° or 240°, 120° on LSXM models

<sup>3</sup> Prog-Z not available on LSXM models

#### 4.4.1 Export Option Frequency Resolution

Frequency programming resolution got LSX Power Sources with the Export Option:

Per U.S.A. Bureau of Industry and Security, ECCN 3A225, frequency control is limited to no better than 0.2% at frequencies of 600 Hz. or more for unrestricted export products. To meet that requirement, frequency programming on all LSX models with the “E” option has four resolution ranges, which round the frequency to the nearest increment, as defined in the table below.

Frequency Resolution for Export Models is:

Range	Resolution
1.00 - 99.99 Hz	0.01 Hz
100-599.9 Hz	0.1 Hz
600 - 999 Hz	2.0 Hz
1000 - 1200 Hz	5.0 Hz

#### 4.4.2 Programmable Output Impedance Ranges by Phase Mode

The programmable range for output impedance varies based on model, phase mode setting. The table below summarizes the available ranges as function of these. Ranges are the same for Real-Time Mode and RMS Mode.

**Note:** For units with T option, impedance is multiplied by the square of the transformer ratio. Thus, for a TR of 2:1, the impedance range is multiplied by 4.

Models	Phase Mode	± Limits	0 - Max Limits
		R +/- Ohms	L + mH
115LSX, 120LSX, 140LSX, 160LSX	Split Phase	-200.00 ~ + 200.00	0 ~ 4.00
	Single Phase	-100.00 ~ + 100.00	0 ~ 2.00
315LSX, 320LSX, 345LSX, 360LSX	Three Phase	-100.00 ~ + 100.00	0 ~ 2.00
	Split Phase	-200.00 ~ + 200.00	0 ~ 4.00
	Single Phase	-100.00 ~ + 100.00	0 ~ 2.00

Table 4-2: Programmable Impedance Ranges by Phase mode

#### 4.4.3 Programmable Impedance operation

To maintain backward compatibility of the programmable impedance function with legacy AMX power sources, the LSX prog Z function operates in the same fashion as the legacy UPC controllers.

When enabling Prog-Z and setting 0 ohm, the LSX controller applies a negative impedance to compensate for the impedance of the output power stages. This has the following implications:

- Turning OFF the Prog-Z function is **NOT** the same as setting turning it on and programming zero ohm.
- With Prog-Z enabled and 0 ohm set, the controller applies a small negative impedance to compensate for the internal Voltage drop of the output amplifiers.



- Since this compensation is a negative impedance - which results in positive feedback - it reduces the stability margin and could cause instabilities with certain types of devices connected to the output (DUTs).

**Additional considerations when using Programmable Impedance functions.**

In order to maximize the setting range for prog-Z, the AC Source controller gradually reduces the bandwidth of the feedback loop. This means that higher impedances (resistance and/or inductance) are slower to react.

At frequency settings of 50~60Hz, this works well in over the entire range. At higher frequencies the impedance accuracy will decrease, especially the inductive part (L).

Also, setting a high resistance (>1ohm) R impedance when the AC source is driving a highly capacitive load can result in instability.

The user should verify the prog-Z stability with the load before using it. ***Tight protection settings (peak and RMS current) are recommended to protect the power source and the load in case the system oscillates.***

Also, when using a negative impedance setting, the AC source can easily become unstable, depending on the load impedance, because negative impedance implies positive feedback which has a higher likelihood of causing instability.

#### 4.5 Low Frequency Operating in Transformer Coupled Mode

LSX-Series output transformers are designed to operate from 45 to 5,000 Hz. In the case of steady-state sine wave output, operation at frequencies as low as 30 Hz (125 Vac primary voltage) is possible.

Operation at lower frequencies - below 30Hz - may cause saturation of the output transformers, but at reduced output voltages, lower frequency operation is possible. The Volt\*Second Product of the output **MUST NOT** exceed the maximum Volt\*Second rating of the transformer to prevent saturation of the transformers when operating at lower frequencies.

For example, to determine the value of reduced voltage at 20Hz operation of the transformer described above:

1. Calculate the Volt•Second Product maximum value of the transformer at 30Hz and 125 Vac

$$T_{30Hz} = \frac{1}{Freq} = \frac{1}{30Hz} = 0.033sec \quad Volt \bullet Sec_{max} = T_{30Hz} \times V_{rms} = 0.033 \times 125 = 4.125volt \bullet sec$$

Calculate the reduced output voltage value at 20Hz with maximum Volt •Second Product value

$$T_{20Hz} = \frac{1}{Freq} = \frac{1}{20Hz} = 0.050sec \quad Volts = \frac{Volt \bullet Sec_{max}}{T_{20Hz}} = \frac{4.125volt \bullet sec}{0.050sec} = 82.5volts$$

Therefore, to prevent output transformer saturation at 20Hz operation, the maximum primary voltage of the transformer should be 82.5Vac.

Systems with transformers connected to the output require special attention when designing transient profiles. It is possible to design transients in which the DC Component of the periodic waveform is not zero. Attempting to push DC voltage through the transformer will cause saturation of the transformer. However, the output transformers are designed to support a single event, half-cycle dropout at 125 Vac primary voltage at 50 Hz without saturating. Continuous operation with an asymmetrical waveform (DC component  $\neq 0$  Vdc) will cause saturation however.

#### 4.6 Protection Modes

PROTECTION	
Protection Modes	Over Current fold-back or trip
	Power fold-back or trip
	Apparent Power fold-back or trip
	Over Voltage trip
	Over Temperature
OVP Range	0 - 105% Vmax

#### 4.7 Metering

MEASUREMENTS		SPECIFICATION
<b>AC Voltage (Vrms)</b>		
Range	0 – 340 VLN / 0-600 VLL	
Resolution	0.01 V	
Accuracy	± 0.1% F.S.	
<b>Frequency (Hz)</b>		
Fundamental Range	15 - 1200 Hz	
Resolution	0.01 Hz	
Accuracy	± 0.1% Rdg	
<b>AC Current (Arms)</b>		
Range	See Model Tables page 8 & 9	
Resolution	0.01 Arms	
Accuracy	± (0.5% + f (kHz) * 0.5%) F.S.	
<b>Current Crest Factor</b>		
Range	1.00 - 10.00	
Resolution	0.01	
Accuracy <sup>4</sup>	± 2.0% F.S.	
<b>AC or DC Power (W)</b>		
Range	See Model Tables page 8 & 9	
Resolution	Front panel & Browser: 1 W, Interfaces: 0.1 W	
Accuracy	± 0.75 % F.S.	
<b>Apparent Power (VA)</b>		
Range	See Model Tables page 8 & 9	
Resolution	Front panel & Browser: 1 VA, Interfaces: 0.1 VA	
Accuracy	± 0.75 % F.S.	
<b>Power Factor</b>		
Range	0.00 - 1.00	
Resolution	0.01	

<sup>4</sup> For currents > 1.0 Arms

## 4.8 Other Measurements

Measurements	
<b>Waveform Capture<sup>5</sup></b>	
Time Domain	1024 samples/period
Parameters	V <sub>LN-A</sub> , V <sub>LN-B</sub> , V <sub>LN-C</sub> , V <sub>LLAB</sub> , V <sub>LLAC</sub> , V <sub>LLBC</sub> , IA, IB, IC
Samples/cycle	1024 (512 in UPC Compatibility mode)
Record Length	1 Period of fundamental Frequency
Bandwidth	100 kHz @ 500 ksps
<b>Harmonics Measurements<sup>5</sup></b>	
Parameters	V <sub>LN-A</sub> , V <sub>LN-B</sub> , V <sub>LN-C</sub> , V <sub>LLAB</sub> , V <sub>LLAC</sub> , V <sub>LLBC</sub> , IA, IB, IC
Harmonics Range	H1 ~ H50
Accuracy – Amplitude	± 1.0 % of RMS Reading
Phase Angle Range	0 ~ 359.9
Accuracy - Phase Angle	< 8 μsec
Bandwidth	100 kHz @ 500 ksps
Display Modes	Table format, Graph Format

## 4.9 Transient Programming

Transients	
<b>Programming<sup>6</sup></b>	
No. of Entries	200 Steps, 400 Segments
Parameters	Voltage, Frequency, Phase B & C, Ramp Time, Dwell Time
Dwell Time Range	0.0 – 10,000,000.0 msec
Ramp Time Range	0.2 – 10,000,000.0 msec
Time Resolution	100 μsec (0.0001 sec)
Edit Modes	Add at End, Insert Before, Delete
<b>Execution</b>	
Run Control	Run from Step # to Step # Run, Step, Restart, Stop
<b>Program Storage</b>	
Non-Volatile	100, Programs + Transients

<sup>5</sup> Not available on LSXM models

<sup>6</sup> Transient programming not available on LSXM models

## 4.10 AC Input Power Requirements

This paragraph lists and defines the input voltage forms that are accepted by the various models within the LSX-Series model range. Each model is listed separately. Refer to the appropriate model when determining proper input service requirements. The input currents listed are for operation at full rated load. Overload conditions will result in higher input currents that still fall within the recommended input service.

The input power transformer of the LSX-Series Power Source has taps for each of the listed power forms - one of which is selected by the factory at time of order. Once selected, the unit will operate at designated voltage,  $\pm 10\%$ .

### 4.10.1 115LSX AC Input

The Model 115LSX single-phase input voltages, required input currents at full rated load and recommended service input currents are stated as below.

NO	INPUT VOLTAGE	INPUT CURRENT	RECOMMENDED SERVICE
1	100 Vac $\pm 10\%$ , 47-63 Hz	22 Arms	25 A
2	110 Vac $\pm 10\%$ , 47-63 Hz	20 Arms	25 A
3	120 Vac $\pm 10\%$ , 47-63 Hz	18 Arms	25 A
4	200 Vac $\pm 10\%$ , 47-63 Hz	11 Arms	15 A
5	208 Vac $\pm 10\%$ , 47-63 Hz	10 Arms	15 A
6	220 Vac $\pm 10\%$ , 47-63 Hz	10 Arms	15 A
7	230 Vac $\pm 10\%$ , 47-63 Hz	9 Arms	15 A
8	240 Vac $\pm 10\%$ , 47-63 Hz	9 Arms	15 A

### 4.10.2 120LSX AC Input

The Model 120LSX single-phase input voltages, required input currents at full rated load and recommended service input currents are stated as below.

NO	INPUT VOLTAGE	INPUT CURRENT	RECOMMENDED SERVICE
1	100 Vac $\pm 10\%$ , 47-63 Hz	22 Arms	25 A
2	110 Vac $\pm 10\%$ , 47-63 Hz	20 Arms	25 A
3	120 Vac $\pm 10\%$ , 47-63 Hz	18 Arms	25 A
4	200 Vac $\pm 10\%$ , 47-63 Hz	10 Arms	15 A
5	208 Vac $\pm 10\%$ , 47-63 Hz	10 Arms	15 A
6	220 Vac $\pm 10\%$ , 47-63 Hz	10 Arms	15 A
7	230 Vac $\pm 10\%$ , 47-63 Hz	9 Arms	15 A
8	240 Vac $\pm 10\%$ , 47-63 Hz	9 Arms	15 A

#### 4.10.3 140LSX AC Input

The Model 140LSX three-phase input voltages, required input currents at full rated load and recommended service input currents are stated as below.

NO	INPUT VOLTAGE	INPUT CURRENT	RECOMMENDED SERVICE
1	208 Vac $\Delta$ $\pm 10\%$ , 47-63 Hz	13 Arms	20 A
2	220 Vac $\Delta$ $\pm 10\%$ , 47-63 Hz	12 Arms	20 A
3	240 Vac $\Delta$ $\pm 10\%$ , 47-63 Hz	11 Arms	15 A
4	220/380 Vac $\pm 10\%$ , 47-63 Hz	7 Arms	10 A
5	230/400 Vac $\pm 10\%$ , 47-63 Hz	7 Arms	10 A
6	240/416 Vac $\pm 10\%$ , 47-63 Hz	6.5 Arms	10 A
7 <sup>7</sup>	277/480 Vac $\pm 10\%$ , 47-63 Hz	5.5 Arms	10 A

#### 4.10.4 160LSX AC Input

The Model 160LSX three-phase input voltages, required input currents at full rated load and recommended service input currents are stated as below.

NO	INPUT VOLTAGE	INPUT CURRENT	RECOMMENDED SERVICE
1	208 Vac $\Delta$ $\pm 10\%$ , 47-63 Hz	20 Arms	30 A
2	220 Vac $\Delta$ $\pm 10\%$ , 47-63 Hz	18 Arms	30 A
3	240 Vac $\Delta$ $\pm 10\%$ , 47-63 Hz	16 Arms	25 A
4	220/380 Vac $\pm 10\%$ , 47-63 Hz	11 Arms	15 A
5	230/400 Vac $\pm 10\%$ , 47-63 Hz	10 Arms	15 A
6	240/416 Vac $\pm 10\%$ , 47-63 Hz	10 Arms	15 A
7 <sup>8</sup>	277/480 Vac $\pm 10\%$ , 47-63 Hz	8 Arms	15 A

#### 4.10.5 315LSX AC Input

The Model 315LSX single-phase input voltages, required input currents at full rated load and recommended service input currents are stated as below.

NO	INPUT VOLTAGE	INPUT CURRENT	RECOMMENDED SERVICE
1	100 Vac $\pm 10\%$ , 47-63 Hz	22 Arms	25 A
2	110 Vac $\pm 10\%$ , 47-63 Hz	20 Arms	25 A
3	120 Vac $\pm 10\%$ , 47-63 Hz	18 Arms	25 A
4	200 Vac $\pm 10\%$ , 47-63 Hz	11 Arms	15 A
5	208 Vac $\pm 10\%$ , 47-63 Hz	10 Arms	15 A
6	220 Vac $\pm 10\%$ , 47-63 Hz	10 Arms	15 A
7	230 Vac $\pm 10\%$ , 47-63 Hz	9 Arms	15 A
8	240 Vac $\pm 10\%$ , 47-63 Hz	9 Arms	15 A

<sup>7</sup> Cost Option

<sup>8</sup> Cost Option

#### 4.10.6 320LSX AC Input

The Model 320LSX single-phase input voltages, required input currents at full rated load and recommended service input currents are stated as below.

NO	INPUT VOLTAGE	INPUT CURRENT	RECOMMENDED SERVICE
1	100 Vac $\pm 10\%$ , 47-63 Hz	22 Arms	25 A
2	110 Vac $\pm 10\%$ , 47-63 Hz	20 Arms	25 A
3	120 Vac $\pm 10\%$ , 47-63 Hz	18 Arms	25 A
4	200 Vac $\pm 10\%$ , 47-63 Hz	11 Arms	15 A
5	208 Vac $\pm 10\%$ , 47-63 Hz	10 Arms	15 A
6	220 Vac $\pm 10\%$ , 47-63 Hz	10 Arms	15 A
7 <sup>9</sup>	230 Vac $\pm 10\%$ , 47-63 Hz	9 Arms	15 A

#### 4.10.7 345LSX AC Input

The Model 345LSX three-phase input voltages, required input currents at full rated load and recommended service input currents are stated as below.

NO	INPUT VOLTAGE	INPUT CURRENT	RECOMMENDED SERVICE
1	208 Vac $\Delta \pm 10\%$ , 47-63 Hz	15 Arms	25 A
2	220 Vac $\Delta \pm 10\%$ , 47-63 Hz	14 Arms	25 A
3	240 Vac $\Delta \pm 10\%$ , 47-63 Hz	12 Arms	20 A
4	220/380 Vac $\pm 10\%$ , 47-63 Hz	8 Arms	15 A
5	230/400 Vac $\pm 10\%$ , 47-63 Hz	8 Arms	15 A
6	240/416 Vac $\pm 10\%$ , 47-63 Hz	7.5 Arms	15 A
7 <sup>10</sup>	277/480 Vac $\pm 10\%$ , 47-63 Hz	6 Arms	15 A

#### 4.10.8 360LSX AC Input

The Model 360LSX three-phase input voltages, required input currents at full rated load and recommended service input currents are stated as below.

NO	INPUT VOLTAGE	INPUT CURRENT	RECOMMENDED SERVICE
1	208 Vac $\Delta \pm 10\%$ , 47-63 Hz	20 Arms	30 A
2	220 Vac $\Delta \pm 10\%$ , 47-63 Hz	18 Arms	30 A
3	240 Vac $\Delta \pm 10\%$ , 47-63 Hz	16 Arms	25 A
4	220/380 Vac $\pm 10\%$ , 47-63 Hz	16 Arms	15 A
5	230/400 Vac $\pm 10\%$ , 47-63 Hz	11 Arms	15 A
6	240/416 Vac $\pm 10\%$ , 47-63 Hz	10 Arms	15 A
7 <sup>11</sup>	277/480 Vac $\pm 10\%$ , 47-63 Hz	8 Arms	15 A

<sup>9</sup> Cost Option

<sup>10</sup> Cost Option

<sup>11</sup> Cost Option

## 4.11 Dimensions & Weight by Model

MODEL	HEIGHT	WIDTH <sup>12</sup>	DEPTH <sup>13</sup>	WEIGHT w/o & [w T]
115LSX	5.25" / 134 mm	19" / 483 mm	23" / 584 mm	70 lbs / 32 kg or [95 lbs / 43 kg]
120LSX	5.25" / 134 mm	19" / 483 mm	23" / 584 mm	80 lbs / 36 kg
140LSX	8.75" / 222 mm	19" / 483 mm	23.12" / 587 mm	120 lbs / 55 kg +[120 lbs / 55 kg]
160LSX	8.75" / 222 mm	19" / 483 mm	23.12" / 587 mm	120 lbs / 55 kg +[120 lbs / 55 kg]
315LSX	5.25" / 134 mm	19" / 483 mm	23" / 584 mm	75 lbs / 34 kg
320LSX	5.25" / 134 mm	19" / 483 mm	23" / 584 mm	85 lbs / 39 kg
345LSX	8.75" / 222 mm	19" / 483 mm	23.12" / 587 mm	125 lbs / 57 kg +[120 lbs / 55 kg]
360LSX	8.75" / 222 mm	19" / 483 mm	23.12" / 587 mm	125 lbs / 57 kg +[120 lbs / 55 kg]

### 4.11.1 Rack Handles

The front panel mounted rack handles are intended for use in installing or removing the power source from a 19" instrument cabinet only.



These handles should **not be used** to carry or move the power source to a different location. Always use a suitable cart for lift to move the power source.

### 4.11.2 Rack Mount Slides

The chassis of the LSX-Series Power Source is designed to accept slide rails. These can be provided as a cost option. For more information, contact your local sales representative or the Pacific Power Source Sales Office.



**Do not** install or remove the power source with less than two persons in view of the unit's weight. It is strongly recommended to use a suitable mechanical lift to install/remove the unit in a cabinet.

<sup>12</sup> Front panel width. Chassis width is 16.75" / 426 mm

<sup>13</sup> Measured from back side of front panel to front panel. Excludes terminal block depth.



4.11.3 Chassis Drawings – 3U - 115LSX & 315LSX

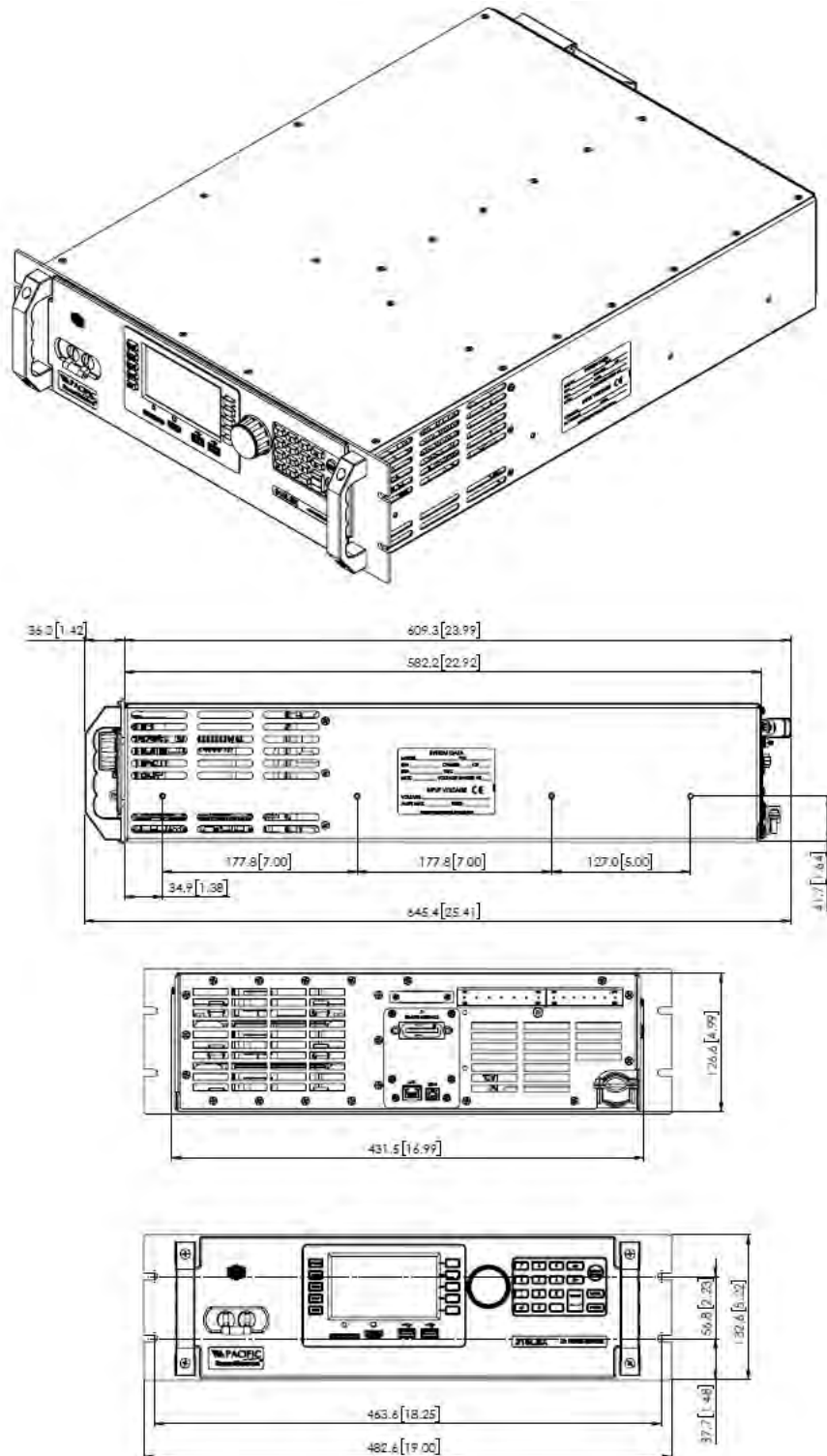


Figure 4-9: Dimension Drawing Models 115LSX & 315LSX

4.11.4 Chassis Drawings – 3U – 120LSX & 320LSX

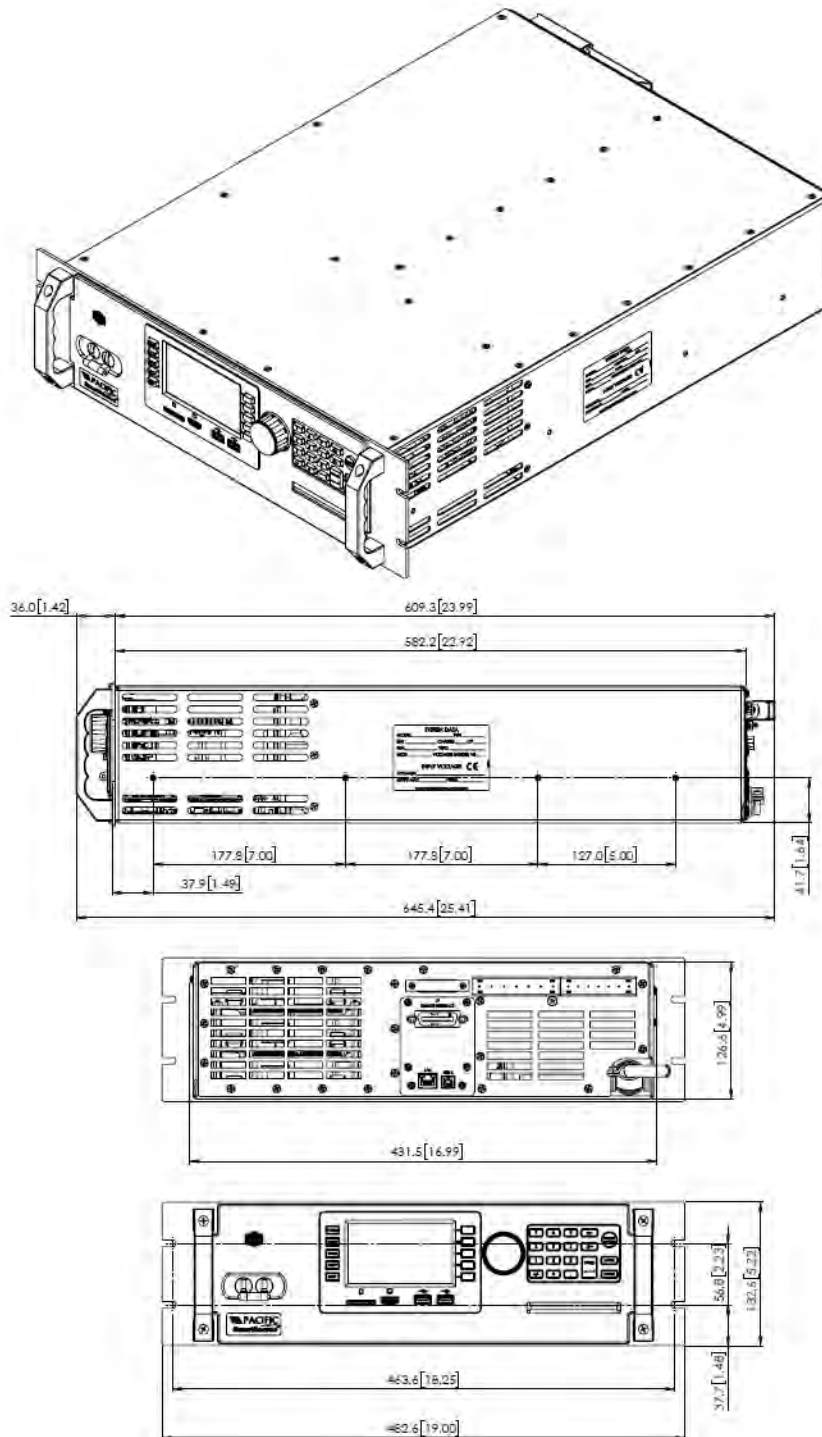


Figure 4-10: Dimension Drawing Models 120LSX & 320LSX

4.11.5 Chassis Drawings – 5U 140LSX, 345LSX, 160LSX & 360LSX

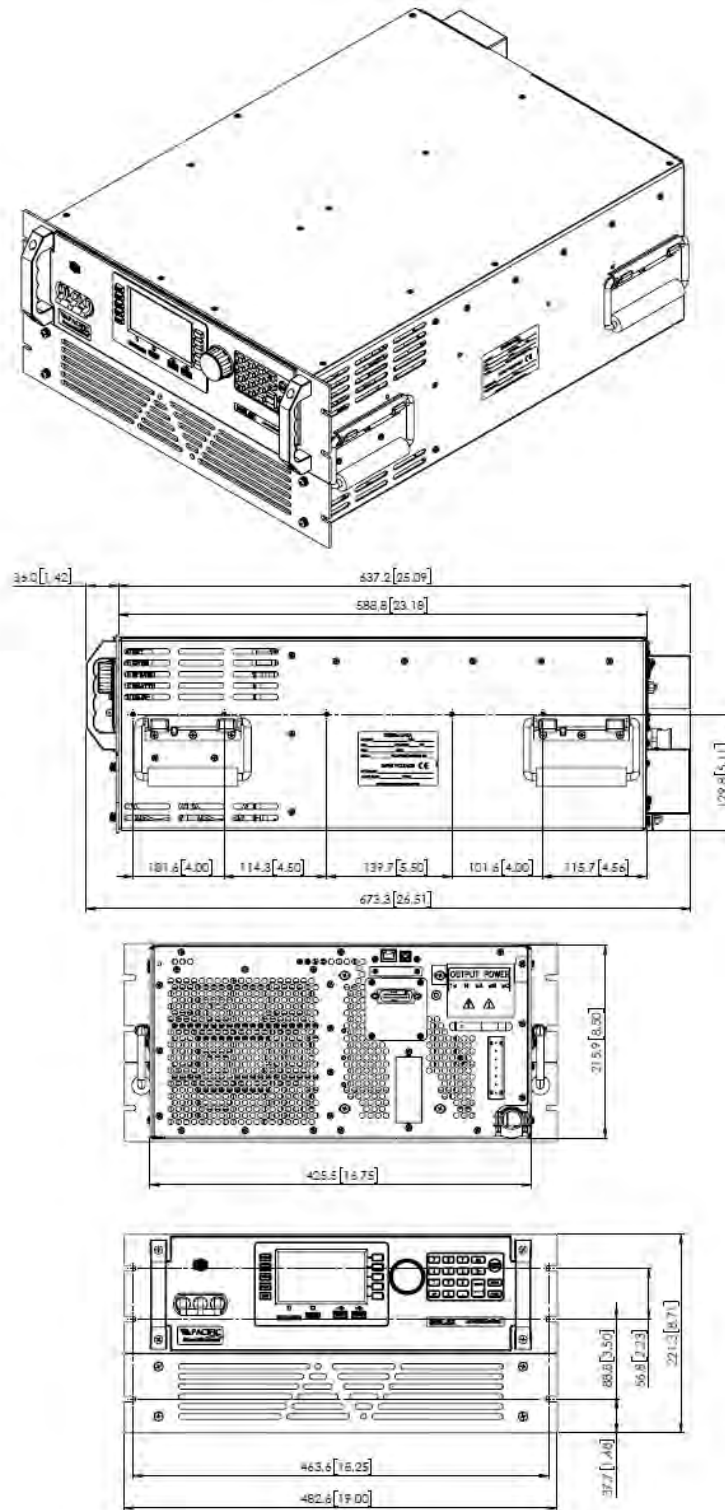
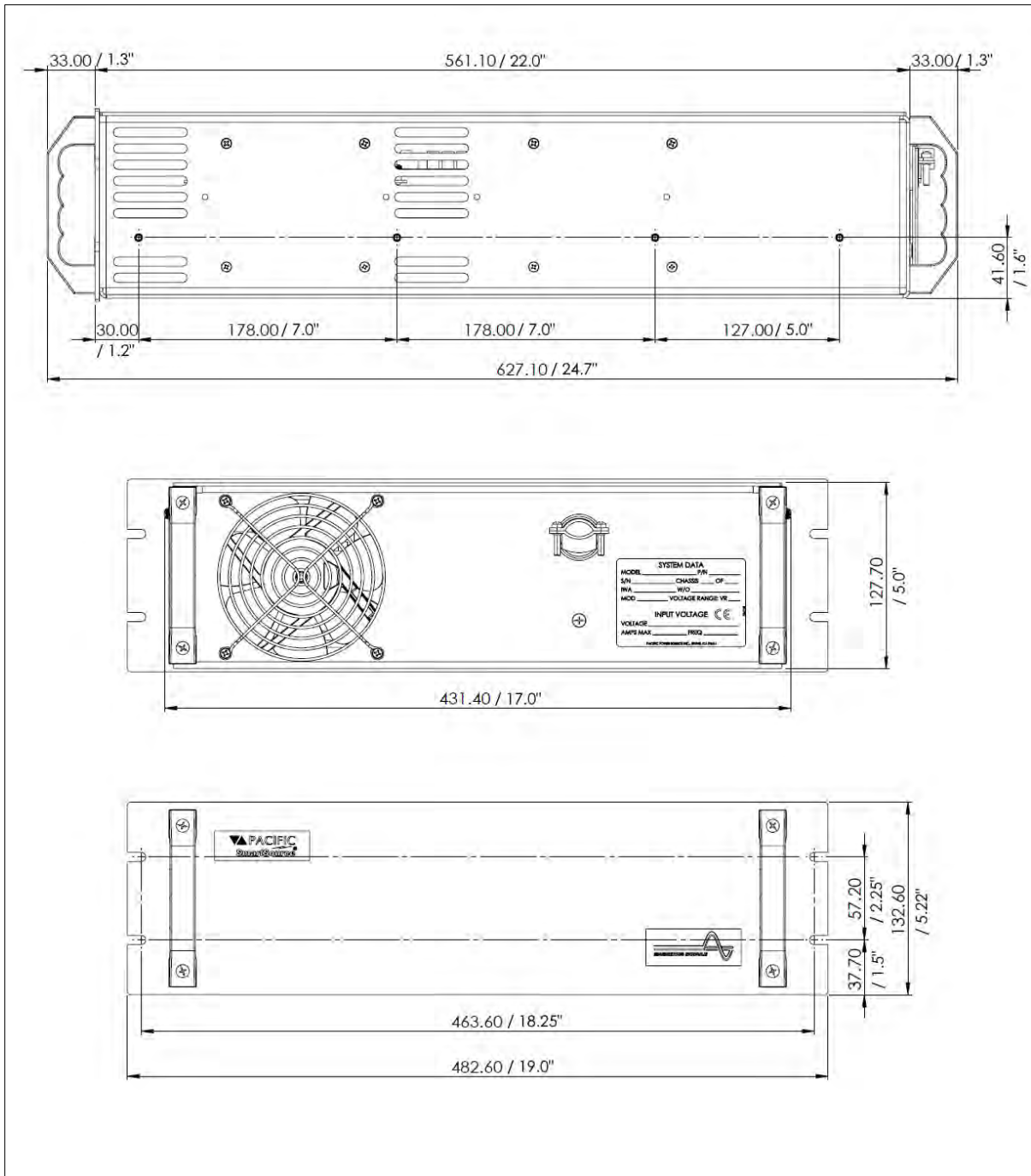


Figure 4-11 Dimension Drawing Models 140LSX, 345LSX, 160LSX & 360LSX

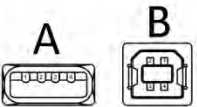
4.11.6 Chassis Drawings – T Option Magnetics Module 3U



## 4.12 Environmental

ENVIRONMENTAL	
Cooling	Fan Cooled, Front and/or Side air intake, rear exhaust
Maximum Air flow by Model:	
115LSX, 120LSX, 315LSX, 320LSX	100 CFM
140LSX, 160LSX, 345LSX, 360LSX	200 CFM
Operating Temperature	0 to 55 °C / 32 to 131 °F
Storage Temperature	-20 to 70 °C / -4 to 158 °F
Humidity	< 95%, non-condensing
Altitude (max.)	1981 m / 6500 feet
Equipment ingress protection rating per IEC 60529	IP20

## 4.13 Digital Interfaces

USB	
USB Standard	USB 2
USB Class	
Front Panel	Type A USB Host (2)
Connector	Type A, standard
Rear Panel	Type A USB Host (1) Type B USB Device (1)
Connector Types	

RS232	
Baud rate:	9600, 14400, 19200, 38400, 57600, 62500, 115200
Parity:	O = Odd = uneven parity E = Even = even parity N = None = no parity bit
Number of data bits:	7 or 8
Number of stop bits:	1 or 2
Handshake:	Xon/Xoff
Signal Levels:	
Inputs (Rx/D)	Maximum input voltage: $\pm 25$ V Input Impedance: 5 k $\Omega$ typical Switching thresholds: $V_H < -3$ V, $V_L > +3$ V
Outputs (Tx/D)	Output voltage (at $R_{LOAD} > 3$ k $\Omega$ ): min $\pm 5$ V, typical $\pm 5.4$ V Output Impedance: < 300 $\Omega$ min., 10 M $\Omega$ typical in power off state Short circuit current: Typ. $\pm 35$ mA typical

<b>Ethernet</b>	
Protocol	Ethernet TCP/IP, 100Mb/1000Mb
Connector	RJ45
Webserver	Built-in
LXI Compliance	Core, version 1.4

<b>GPIB</b>	
IEEE Standard	IEEE488,1, IEEE488.2 (2003 incl., NI HS488) IEC 60488-1, IEC 60488-2 (2004)
IEEE Functions Supported	SH1, AH1, T6, L3, SR1, RL1, DC1, DT1
Connector	Amphenol 24 pin, Micro ribbon connector. Rear Panel Set screws: M3.5×0.6 metric threads.

#### 4.14 Auxiliary I/O

The Auxiliary I/O functions are only available on all LSX Series power source models.

The following technical specifications apply to the Auxiliary I/O functions.

AUX I/O SIGNAL SPECIFICATIONS	
<b>Digital Inputs</b>	
Input Signals	Remote Inhibit, External Trigger Input, Phase Sync, User Inputs (3)
Voltage Levels	Logic low: $V_{in} < 0.4\text{ V}$ Logic High: $V_{in} > 2.0\text{ V}$
Input Impedance	10 k $\Omega$
Absolute max. voltage	12V
<b>Digital Outputs</b>	
Output Signals	<i>Open Collector (0.5A max. protection):</i> FORM Relay Control, Transformer Relay Control <b>Note:</b> DO1 and DO2 are TTL outputs with 5.2V output and 200 $\Omega$ output impedance. Into a 5k $\Omega$ load, the output voltage is ~5V. <b>Note:</b> DO3 and DO4 are open-drain outputs with internal pull-up of 1k to 5.5V with a diode protection. At no load, these outputs will measure 5.5V. With a 5k $\Omega$ impedance, these outputs will measure ~4.6V. <i>TTL Level:</i> Relay State/Function Strobe / Trigger Out Phase Reference (sync output) User programmable outputs (2)
Voltage Levels @ 0.4 mA	Logic low: $V_{in} < 0.4\text{ V}$ Logic High: $V_{in} > 4.6\text{ V}$
Output impedance	200 $\Omega$
<b>Analog Inputs</b>	
Signals	Analog Inputs (4)
Voltage Range	-10V – 10V
Accuracy	$\pm 0.1\%$ F.S.
Sampling Rate	10 Hz or 10 times/sec
Open Circuit Level	2 ~ 3 % of F.S. if analog input is left floating (no connection)
Input Impedance	5 k $\Omega$
Absolute max. voltage	12V
<b>Analog Outputs</b>	
Signals	Analog Outputs (4)
Voltage Range	0V – 10V
Accuracy	$\pm 0.1\%$ F.S. (with 5 k $\Omega$ load or higher)
Update Rate	10 Hz or 10 times/sec
Output Impedance	5 k $\Omega$
<b>Power</b>	
Output	12.0 Vdc
Accuracy	$\pm 0.1\%$ Vdc
Max. Current	0.5 Adc
<b>RS232</b>	
Signals	Tx, Rx
Handshake	Xon/ Xoff
Baud rates	9600 – 460800 bps

---

### **Auxiliary I/O Signal Protection Information and Recommendations**

- All the signals on the auxiliary I/O DB25 port have double insulation with respect to high voltage. They are safe to touch (SELV) and safe to connect to any other equipment.
- These signals are referenced to earth, so any data acquisition card or equipment used to control the power source should be referenced to the same earth as the power source. For the power source unit, earth is its chassis.
- If the controlling computer connected to the power source is connected to an earth with different potential - this can happen when using different outlets or AC utility circuits - , that voltage difference can damage low-signal circuits.
- Analog outputs cannot be negative and cannot be higher than 5V. Any DAQ card or instrument used to monitor/read these outputs must have a sufficient input voltage range.
- In general, it is recommended to limit signal input voltages with series resistors and clamping diodes in case the “source” can generate a voltage higher than the maximum allowed by the analog inputs of the power source. See relevant specification on the previous page.



## 5 Unpacking and Installation

### 5.1 Unpacking

This equipment is heavy and requires two persons to lift or carry. To remove the equipment from its packaging, use the handgrips on the sides for 5U and 8U chassis size models to lift the unit from its packaging and place it on a suitable surface that is rated to support the weight of the unit. Two persons are required to remove the LSX unit from its packaging, one on each long side of the box.

If the unit was shipped with the optional external magnetics module (T-Option), it will be in its own separate packaging.



**NOTE:** THE MAGNETICS MODULE FOR, MODELS 140LSX, 160LSX, 345LSX and 360LSX ARE **NOT** A ONE-PERSON LIFT, AND MUST BE LIFTED BY TWO OR MORE INDIVIDUALS IN ORDER TO REDUCE CHANCE OF PHYSICAL INJURY.

### 5.2 Inspection

The LSX Series® of AC power sources are carefully inspected before shipment. If instrument damage has occurred during transport, please inform Pacific Power Source' nearest sales and service office or representative.

Refer to "check line voltage" to check the line voltage selection and fuse type.

### 5.3 Lifting and Carrying Instructions



## CAUTION

**THIS UNIT IS HEAVY.** Two persons are required to lift or carry this unit. DO NOT attempt to lift alone. DO NOT use the front panel rack handles alone to lift this unit. The unit must be supported in front and back when carrying.



## AVERTISSEMENT

CET EQUIPEMENT EST LOURD. Deux personnes sont requises pour transporter ou soulever cet équipement. NE PAS tenter de soulever ou déplacer seul. NE PAS utiliser les poignées en face avant pour soulever l'appareil. L'équipement doit être pris en charge à l'avant et à l'arrière pour le transport.

## 5.4 Chassis Placement

All LSX-Series Power Sources are designed to fit into a standard 19 inch rack. Provisions for mounting slide rails are included in the chassis. The power source can also be used as a bench-top unit, if desired.



**Note:** The front panel handles are not designed to carry the entire unit. It must be supported on front and back or both sides by two persons when being handled.

Select an appropriate location for the unit. Key points to consider when locating the chassis are:

1. **PROXIMITY TO THE LOAD** - The power source should be located as close to the load as possible. This helps to reduce distribution losses. These losses become more critical as the output frequency increases.
2. **VENTILATION** - The chassis requires good ventilation to adequately cool the internal components. Airflow ranges from 200 to 600 CFM. The minimum clearance requirement for each model is listed below.

MODELS	MINIMUM CLEARANCE REQUIREMENT
140LSX, 160LSX, 345LSX, 360LSX.	12 inches front and back
115LSX, 120LSX, 315LSX, 320LSX	2 inches on each side and 12 inches to the rear

*Table 5-1: Required ventilation clearances by model*

When the power source is placed in a 19-inch rack, it must be supported by either chassis slides or full depth angle brackets. The front panel alone will not support the weight of the power source. Chassis slides are available from Pacific Power Source as a cost option. Call factory service for details.

After the location for the unit is selected, verify that the input voltage of the power source is correct (Input voltage is stated on the system ID label). If it requires changing, refer to section 5.6, “AC Input Connections” on page 59 for instructions.

Also check that the output transformer ratio setting is correct. If not, reconfigure to the desired ratio.

After the input voltage form and output transformer ratio have been verified, install the power source into the rack or place it into its final position. Make the necessary input and output connections as stated in section 5.6 and section 5.12 respectively.

## 5.5 Verify Correct AC Input Line Voltage

The LSX Series® power supply is available with either single or three phase AC input voltage configurations and supports multiple input voltage settings. Prior to connecting the AC power source to the local mains, it is important to check the type label on the unit to verify that its AC input configuration matches the local utility power.

Do not connect the power supply to the mains if the AC input voltage, phasing and frequency does not match.



### CAUTION

**DO NOT** CONNECT AN LSX MODEL TO AN INCORRECT UTILITY LINE VOLTAGE AS DAMAGE TO THE UNIT MAY OCCUR.



### AVERTISSEMENT

**NE PAS** CONNECTER UNE LSX MODÈLE À UN UTILITAIRE TENSION EN PANNE QUI PEUT SE PRODUIRE.

## 5.6 AC Input Connections

All LSX models include an attached input power cord and plug. Input voltage form and requirements of the input power configuration for the LSX-Series Power Source varies by model. Each is discussed in a separate sections following. Please refer to the appropriate model's section paragraph for the model being installed.

## 5.6.1 Input Voltage Configuration – Model 115LSX

**CAUTION**

**DISCONNECT** THIS UNIT FROM THE INPUT SERVICE AND ALLOW 15 MINUTES FOR INTERNAL CAPACITOR VOLTAGES TO BLEED DOWN BEFORE REMOVING THE TOP COVER. HIGH VOLTAGE HAZARD WILL BE PRESENT INSIDE THE UNIT WHEN TOP COVER IS REMOVED AND STILL CONNECTED TO INPUT SERVICE

**AVERTISSEMENT**

**DÉCONNECTEZ** CET APPAREIL DU SERVICE D'ENTRÉE ET PERMETTEZ 15 MINUTES POUR QUE LES TENSIONS INTERNES DU CONDENSATEUR AURA ÉTÉ SAIGNÉE AVANT D'ENLEVER LE COUVERCLE SUPÉRIEUR.

UN RISQUE DE HAUTE TENSION SERA PRÉSENT À L'INTÉRIEUR DE L'UNITÉ LORSQUE LE COUVERCLE SUPÉRIEUR EST ENLEVÉ ET CONNEXION AU SERVICE D'ENTRÉE

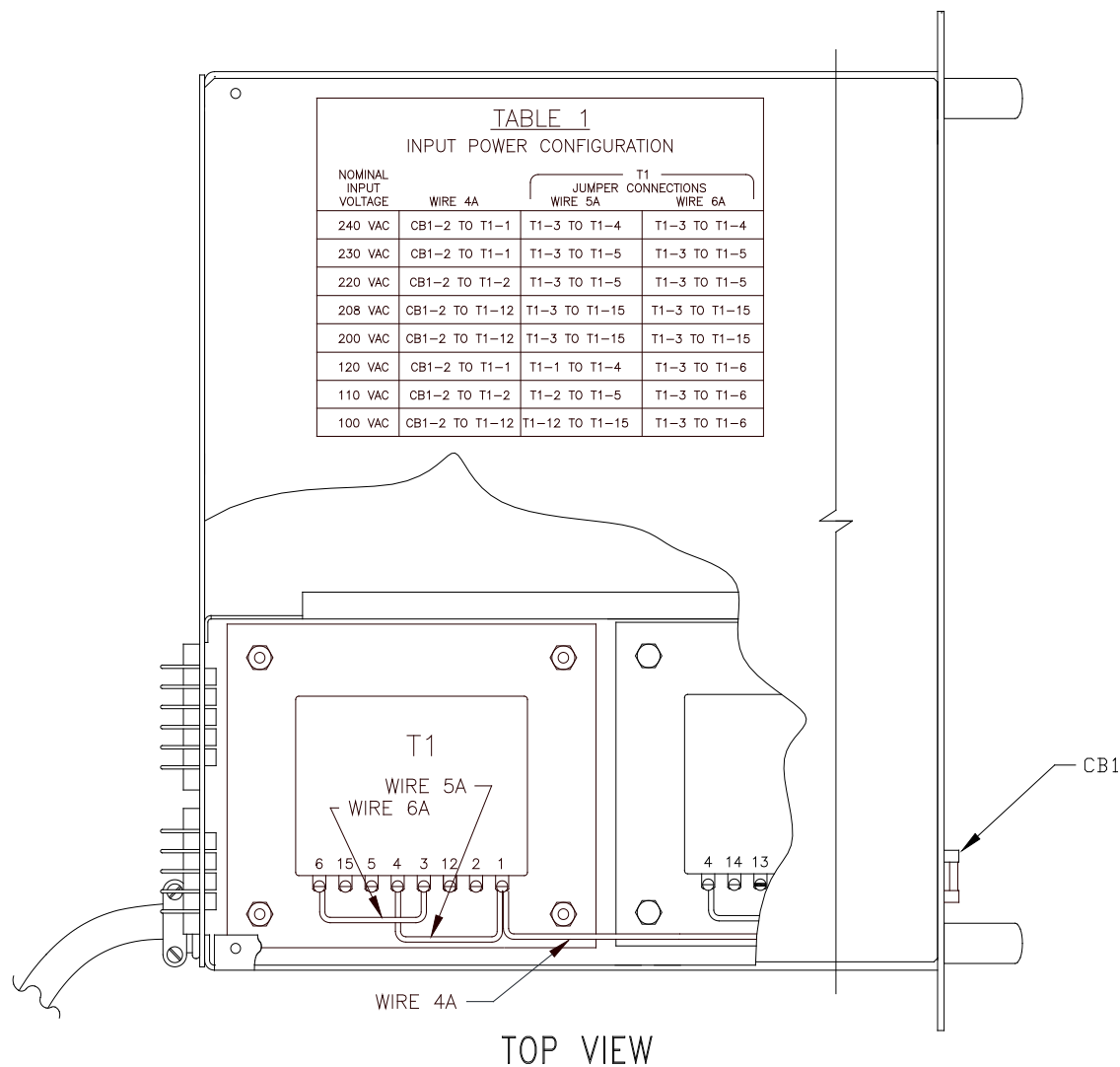
The 115LSX Power Sources has been designed to accept most standard single-phase input voltage forms. This is accomplished through the use of a tapped, input power transformer. Configuring the proper input form is a matter of setting jumpers in the appropriate positions. The system is designed for use with input frequencies of 47 to 63 Hz. (Optionally, the systems may be used with input frequencies of up to 440 Hz. Contact the factory for details.)

Figure 5-2 shows the location of the various jumpers which need to be moved to change input voltage form. The position of these jumpers is listed on the accompanying table.

To change the input power form, remove the top cover, then connect the jumpers as stated in the table for the desired input voltage. Jumpers are located on the input power transformer (T1). Refer to the table in Figure 5-2 for the proper setting.

After configuring the input voltage form, check connections and ensure that they are tight and in the correct position. Replace the top cover.

The Power Source can now be connected to an appropriate AC outlet via the input power cord provided. Refer to Section 4.10 for minimum input service requirements of the various model's input voltage forms.



**TOP VIEW**

SOME DETAIL OMITTED FOR CLARITY.  
120 VAC CONFIGURATION SHOWN

*Figure 5-2: AC Input Transformer Tap Settings – Models 115LSX*

## 5.6.2 Input Voltage Configuration – Models 120LSX &amp; 320LSX

**CAUTION**

**DISCONNECT** THIS UNIT FROM THE INPUT SERVICE AND ALLOW 15 MINUTES FOR INTERNAL CAPACITOR VOLTAGES TO BLEED DOWN BEFORE REMOVING THE TOP COVER. HIGH VOLTAGE HAZARD WILL BE PRESENT INSIDE THE UNIT WHEN TOP COVER IS REMOVED AND STILL CONNECTED TO INPUT SERVICE

**AVERTISSEMENT**

**DÉCONNECTEZ** CET APPAREIL DU SERVICE D'ENTRÉE ET PERMETTEZ 15 MINUTES POUR QUE LES TENSIONS INTERNES DU CONDENSATEUR AURA ÉTÉ SAIGNÉE AVANT D'ENLEVER LE COUVERCLE SUPÉRIEUR.

UN RISQUE DE HAUTE TENSION SERA PRÉSENT À L'INTÉRIEUR DE L'UNITÉ LORSQUE LE COUVERCLE SUPÉRIEUR EST ENLEVÉ ET CONNEXION AU SERVICE D'ENTRÉE

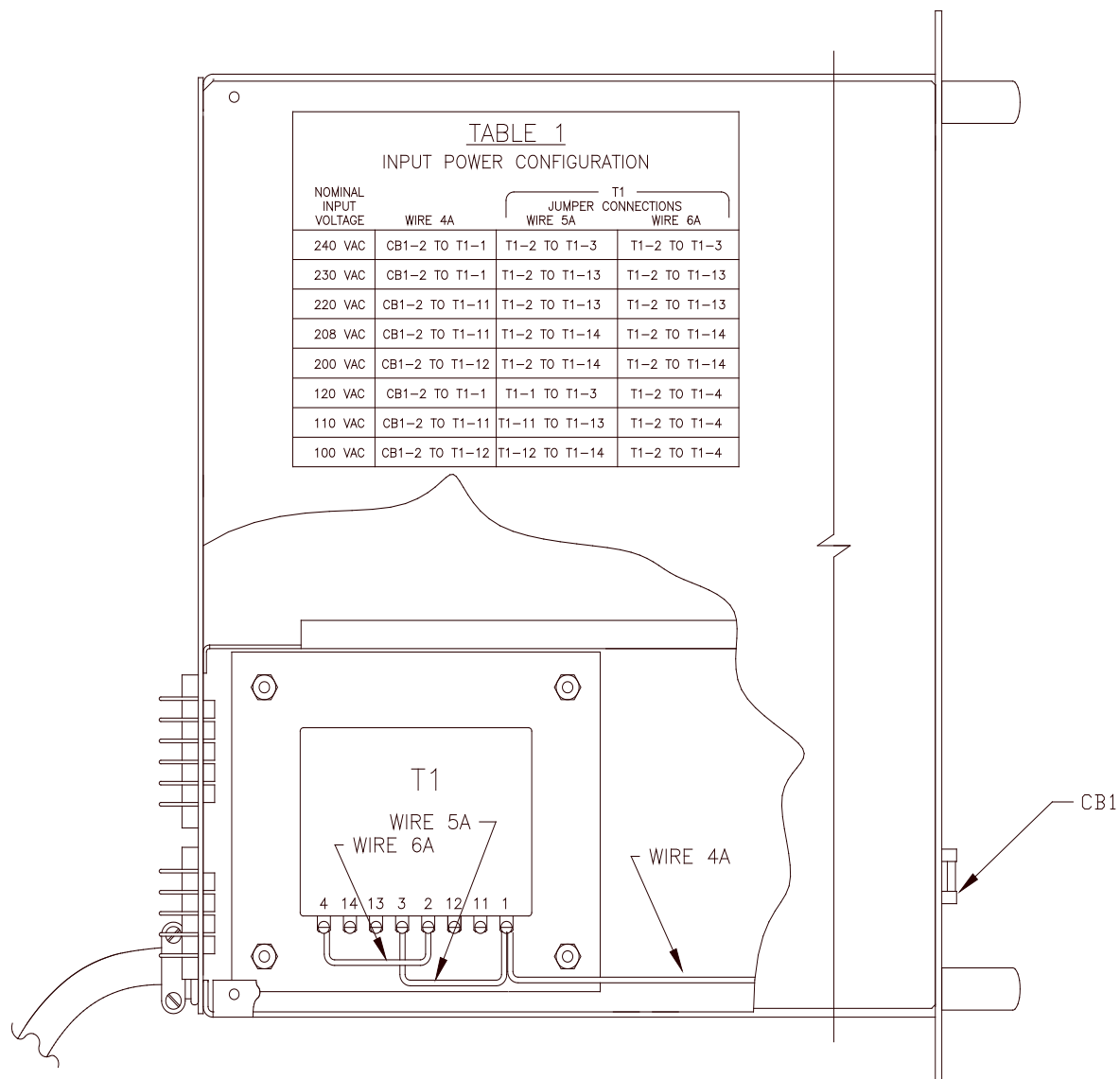
The 120LSX and 320LSX Power Sources have been designed to accept most standard single-phase input voltage forms. This is accomplished through the use of a tapped, input power transformer. Configuring the proper input form is a matter of setting jumpers in the appropriate positions. The system is designed for use with input frequencies of 47 to 63 Hz. (Optionally, the systems may be used with input frequencies of up to 440 Hz. Contact the factory for details.)

Figure 5-2 shows the location of the various jumpers which need to be moved to change input voltage form. The position of these jumpers is listed on the accompanying table.

To change the input power form, remove the top cover, then connect the jumpers as stated in the table for the desired input voltage. Jumpers are located on the input power transformer (T1). Refer to the table in Figure 5-2 for the proper setting.

After configuring the input voltage form, check connections and ensure that they are tight and in the correct position. Replace the top cover.

The Power Source can now be connected to an appropriate AC outlet via the input power cord provided. Refer to Section 4.10 for minimum input service requirements of the various model's input voltage forms.



**TOP VIEW**

SOME DETAIL OMITTED FOR CLARITY.  
120 VAC CONFIGURATION SHOWN

*Figure 5-3: AC Input Transformer Tap Settings – Models 120LSX & 320LSX*

## 5.6.1 Input Voltage Configuration – Model 315LSX

**CAUTION**

**DISCONNECT** THIS UNIT FROM THE INPUT SERVICE AND ALLOW 15 MINUTES FOR INTERNAL CAPACITOR VOLTAGES TO BLEED DOWN BEFORE REMOVING THE TOP COVER. HIGH VOLTAGE HAZARD WILL BE PRESENT INSIDE THE UNIT WHEN TOP COVER IS REMOVED AND STILL CONNECTED TO INPUT SERVICE

**AVERTISSEMENT**

**DÉCONNECTEZ** CET APPAREIL DU SERVICE D'ENTRÉE ET PERMETTEZ 15 MINUTES POUR QUE LES TENSIONS INTERNES DU CONDENSATEUR AURA ÉTÉ SAIGNÉE AVANT D'ENLEVER LE COUVERCLE SUPÉRIEUR.

UN RISQUE DE HAUTE TENSION SERA PRÉSENT À L'INTÉRIEUR DE L'UNITÉ LORSQUE LE COUVERCLE SUPÉRIEUR EST ENLEVÉ ET CONNEXION AU SERVICE D'ENTRÉE

The 315LSX Power Source has been designed to accept most standard single-phase input voltage forms. This is accomplished through the use of a tapped, input power transformer. Configuring the proper input form is a matter of setting jumpers in the appropriate positions. The system is designed for use with input frequencies of 47 to 63 Hz. (Optionally, the systems may be used with input frequencies of up to 440 Hz. Contact the factory for details.)

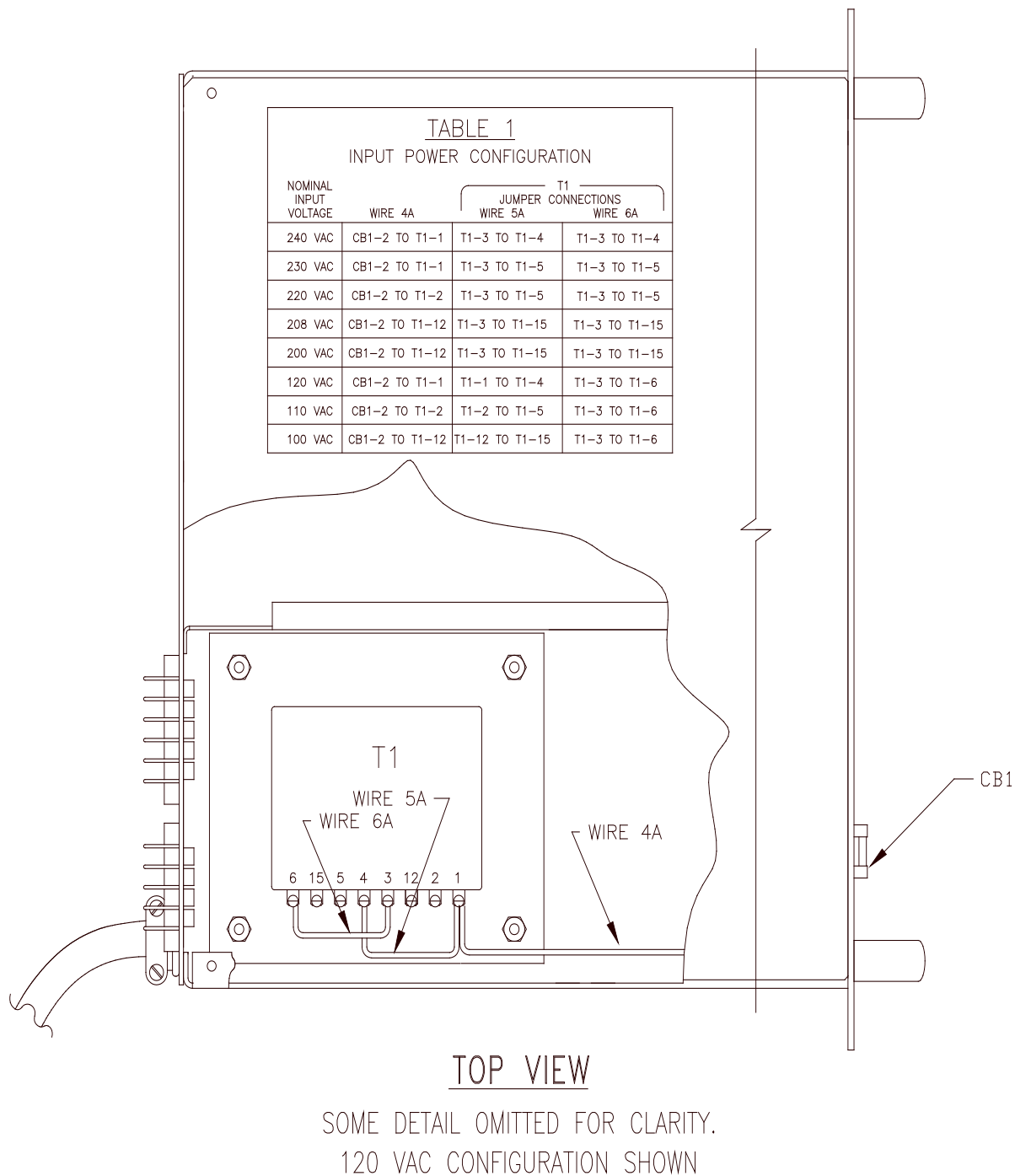
Figure 5-2 shows the location of the various jumpers which need to be moved to change input voltage form. The position of these jumpers is listed on the accompanying table.

To change the input power form, remove the top cover, then connect the jumpers as stated in the table for the desired input voltage. Jumpers are located on the input power transformer (T1). Refer to the table in Figure 5-2 for the proper setting.

After configuring the input voltage form, check connections and ensure that they are tight and in the correct position. Replace the top cover.

The Power Source can now be connected to an appropriate AC outlet via the input power cord provided. Refer to Section 4.10 for minimum input service requirements of the various model's input voltage forms.





*Figure 5-4: AC Input Transformer Tap Settings – Model 315LSX*

## 5.6.2 Input Voltage Configuration – Model 140, 160, 345 and 360LSX

**CAUTION**

**DISCONNECT** THIS UNIT FROM THE INPUT SERVICE AND ALLOW 15 MINUTES FOR INTERNAL CAPACITOR VOLTAGES TO BLEED DOWN BEFORE REMOVING THE TOP COVER. HIGH VOLTAGE HAZARD WILL BE PRESENT INSIDE THE UNIT WHEN TOP COVER IS REMOVED AND STILL CONNECTED TO INPUT SERVICE

**AVERTISSEMENT**

**DÉCONNECTEZ** CET APPAREIL DU SERVICE D'ENTRÉE ET PERMETTEZ 15 MINUTES POUR QUE LES TENSIONS INTERNES DU CONDENSATEUR AURA ÉTÉ SAIGNÉE AVANT D'ENLEVER LE COUVERCLE SUPÉRIEUR.

UN RISQUE DE HAUTE TENSION SERA PRÉSENT À L'INTÉRIEUR DE L'UNITÉ LORSQUE LE COUVERCLE SUPÉRIEUR EST ENLEVÉ ET CONNEXION AU SERVICE D'ENTRÉE

The 140LSX, 160LSX, 345LSX and 360LSX Power Sources have been designed to accept most standard three phase input voltage forms. This is accomplished through the use of a tapped, input power transformer. Configuring the proper input form is a matter of setting jumpers in the appropriate positions. The system is designed for use with input frequencies of 47 to 63 Hz. (Optionally, the systems may be used with input frequencies of up to 440 Hz. Contact the factory for details.)

Figure 5-3 shows the location of the various jumpers which need to be moved to change input voltage form. The position of these jumpers is listed on the accompanying table.

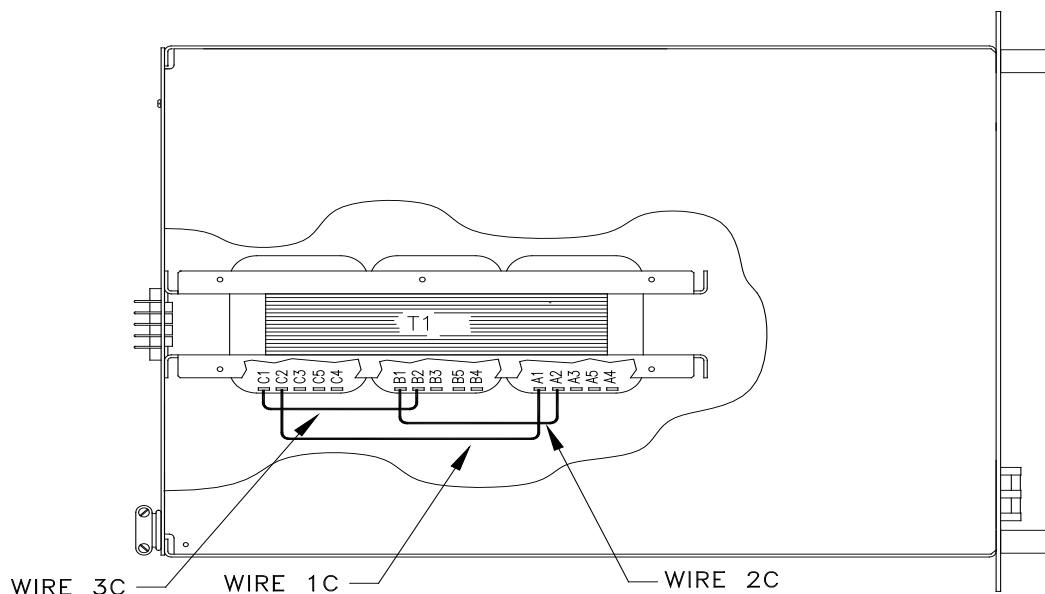
To change the input power form, remove the top cover, then connect the jumpers as stated in the table for the desired input voltage. Jumpers are located on the input power transformer (T1). Refer to the table in Figure 5-3 for the proper setting.

After configuring the input voltage form, check connections and ensure that they are tight and in the correct position. Replace the top cover.

The Power Source can now be connected to an appropriate distribution panel via the terminal block and appropriately sized wiring. **Consult an electrician to ensure compliance to local electrical codes.**

Refer to Section 4.10 for minimum input service requirements of the various model's input voltage forms.

NOMINAL INPUT VOLTAGE	T1 JUMPER CONNECTIONS		
	WIRE 1C	WIRE 2C	WIRE 3C
277/480 VAC	REFER TO SECTION 9, MODIFICATIONS		
240/416 VAC	T1-C4 TO T1-A4	T1-A4 TO T1-B4	T1-B4 TO T1-C4
230/400 VAC	T1-C5 TO T1-A5	T1-A5 TO T1-B5	T1-B5 TO T1-C5
220/380 VAC	T1-C3 TO T1-A3	T1-A3 TO T1-B3	T1-B3 TO T1-C3
240 VAC DELTA	T1-C4 TO T1-A1	T1-A4 TO T1-B1	T1-B4 TO T1-C1
230 VAC DELTA	T1-C5 TO T1-A1	T1-A5 TO T1-B1	T1-B5 TO T1-C1
220 VAC DELTA	T1-C3 TO T1-A1	T1-A3 TO T1-B1	T1-B3 TO T1-C1
208 VAC DELTA	T1-C2 TO T1-A1	T1-A2 TO T1-B1	T1-B2 TO T1-C1



TOP VIEW

SOME DETAIL OMITTED FOR CLARITY  
208 DELTA CONFIGURATION SHOWN

Figure 5-5: AC Input Transformer Tap Settings – Models 140, 160, 345 and 360LSX

## 5.6.3 Input Power Wiring Requirements

**CAUTION**

**LETHAL VOLTAGE ARE PRESENT AT INPUT TERMINALS OF THIS EQUIPMENT.  
ALWAYS CONNECT "CHS or GND" TERMINAL TO EARTH POTENTIAL.  
FAILURE TO DO SO WILL CREATE A SHOCK HAZARD.**

**AVERTISSEMENT**

**DES TENSIONS LÉTALES SONT PRÉSENTES AUX BORNES D'ENTRÉE DE CET ÉQUIPEMENT.  
TOUJOURS CONNECTER LE TERMINAL "CHS or GND" AU POTENTIEL DE TERRE.  
LE NON-RESPONSABILITÉ CRÉERA UN RISQUE DE CHOC.**

**CAUTION: USE COPPER CONDUCTOR WIRING ONLY**

**Use only copper conductor (CU) wiring for all AC Input, AC Output and Ground Connections.**

**ATTENTION: UTILISER UNIQUEMENT LE CÂBLAGE DU  
CONDUCTEUR EN CUIVRE**

**Utilisez uniquement un câblage à conducteur en cuivre (CU) pour toutes les connexions  
d'entrée CA, de sortie CA et de mise à la terre.**

All LSX AC power source models are supplied with an AC input power cord. Install an appropriate plug onto the end of the power cord and connect to the proper outlet. Refer to Section 4.10 for recommended input service of the configured input voltage form.

		Wire Color ( US Models )	Wire Color ( CE Models )
SINGLE PHASE	LINE ( HI )	Black	Brown
	NEUTRAL ( LO )	White	Blue
	GROUND ( CHS )	Green	Green/Yellow
THREE PHASE	LINE 1 ( L1 or A )	Black	Brown
	LINE 2 ( L2 or B )	White	Black
	LINE 3 ( L3 or C )	Red	Grey
	GROUND ( CHS )	Green	Green/Yellow

**Note:** It is the user's responsibility to meet all local and national electrical codes when installing this equipment.

### 5.6.4 Terminal Block Types by Model

This section describes the input ,output and V sense terminal blocks by model.

#### 5.6.4.1 3U Chassis Models

Terminal	Part Number	Poles	Wire Size Range	Screw Size
Output	705077	5	#12-22 AWG, Wire lug 8.1 mm / 0.32" max.	#6-32 philslot screws
V Sense	705090	4	#12-22 AWG Cu	#6-32 zinc-plated philslot screws
Ground Stud	782066-016	1	6-32 X 1/2" PAN HD. PHIL, INTERNAL LOCK	

#### 5.6.4.2 5U Chassis Models

Terminal	Part Number	Poles	Wire Size Range	Screw Size
Output	705080	5	#6-14 AWG, strip length 8 mm / 0.31"	Steel, zinc plated
V Sense	705090	4	#12-22 AWG Cu	#6-32 zinc-plated philslot screws
Ground Stud	782049	1	10-32 X 1/2" PAN HEAD PHILLIPS - BRASS.	

#### 5.6.4.3 8U Chassis Models

Terminal	Part Number	Poles	Wire Size Range	Screw Size
AC Input	705224	5	#4 - 20 AWG, strip length 16 mm	M5 slotted screw, Torque .23. Nm max.
	or 705110			
Output	705182	5	#1/0-6 AWG / 50 - 16 mm <sup>2</sup> , strip length 24 mm	M6 slotted screw, Torque 8 Nm max.
	or 705183			
V Sense	705067	4	#12-22 AWG Cu	#6-32 steel philslot screws
Ground Stud	785019-024	1	BOLT, BRASS, 1/4-20 X 3/4 FULLY THREADED	

## 5.7 Grounding Requirements



### CAUTION: USE COPPER CONDUCTOR WIRING ONLY

Use only copper conductor (CU) wiring for all AC Input, AC Output and Ground Connections.



### ATTENTION: UTILISER UNIQUEMENT LE CÂBLAGE DU CONDUCTEUR EN CUIVRE

Utilisez uniquement un câblage à conducteur en cuivre (CU) pour toutes les connexions d'entrée CA, de sortie CA et de mise à la terre.

#### 5.7.1 Chassis Ground Connection Required



### CAUTION

SHOCK HAZARD: Equipment must be grounded.



### AVERTISSEMENT

RISQUE DE CHOC: l'équipement doit être mis à la terre.

The unit **MUST** be grounded using proper Earth Ground at all times. Correct grounding of your electrical system infrastructure according to applicable national standards must also be observed.

#### 5.7.2 Output Neutral Grounding

The output neutral terminals of the power source are **NOT** connected to earth ground but rather floating. This allows the output of the power source to float with respect to ground. Some loads will have their neutral input grounded, which will result in the power source neutral being grounded through the load. Alternatively, the user may ground the output neutral terminals himself by running a suitable wire size from one of the output neutral terminals to the ground stud on the rear panel of the power source.

Grounding the output neutral can help reduce common mode noise at the output of the power source.

## 5.8 AC Input Circuit Breaker

This product is fitted with a mains input circuit breaker on the left hand side of the front panel. The power off position of the circuit breaker handle is marked “O”. The power on position of the circuit breaker is marked “I”.

## 5.9 Cleaning



### CAUTION

**BEFORE** you clean the unit, switch the unit off at the front panel breaker **AND** remove all mains power using the mains disconnect.

- Please do **NOT** use any organic solvent capable of changing the nature of the plastic such as benzene or acetone.
- Please ensure that no liquid is allowed to penetrate this product.



### ATTENTION

**AVANT** de nettoyer l'appareil, mettez l'appareil hors tension au niveau du disjoncteur de face avant **ET** retirez tout câble d'alimentation secteur.

- Ne pas utiliser **de** solvant organique capable de changer la nature de la matière plastique tel que le benzène ou l'acétone.
- Veiller à ce qu'aucun liquide ne pénètre à l'intérieur de l'appareil

To clean this product, use a soft or slightly damp cloth.



## 5.10 Air Intake Filter Removal and Cleaning

Units equipped with a removable air intake filter must have their filter material cleaned on a regular basis. A six-month cleaning interval is recommended. For units deployed in particularly dirty environments, this cleaning interval should be shortened to three months or less to prevent the air filter from clogging up with dirt. This applies to both Master units and Auxiliary units.



Figure 5-6: Air Intake Filter Removal

### 5.10.1 Air Filter Removal

To remove the air filter, proceed as follows:

1. Turn the unit off first. Using a small Philips screwdriver
2. Remove the four Philips screws from the corners of the filter panel on the front of the unit.
3. Pull the filter panel toward you carefully and remove the filter material.

### 5.10.2 Filter Cleaning

Use warm water and some mild detergent to rinse all dirt out of the filter material. Allow the filter to dry for 2 hours or more till fully dry before re-installing. If the filter material is too dirty to clean, replace with a new filter. Contact customer service for replacement filters.

### 5.10.3 Air Filter Installation

To reinstall the filter material, proceed as follows:

1. Place the cleaned filter material against the lower part of the units front panel.
2. Line up the filter so the filter corners align with the four corners of the filter space.
3. Install the removable filter panel using the four screws.

## 5.11 Liquids

The LSX Series® of AC power sources are not protected against liquid spills. Do not install where chemicals are used or where liquids could be spilled into the unit.

## 5.12 Transformer Output Voltage Configurations

This paragraph describes the configuration of the Output Voltage Range for the ASX-Series Power Source. The LSX-Series Power Source can be configured for several different Output Voltage Ranges. The standard output configurations with and without the Transformer option are:

	Transformer Ratio	Voltage Range	Models
Direct Coupled	n/a	0-132 Vac LN	Direct-Coupled Output, standard on Models 115LSX, 160LSX, 315LSX & 360LSX
	n/a	0-135 Vac LN	Direct-Coupled Output, standard on Models 115LSX, 160LSX, 315LSX & 360LSX
	n/a	0-150 Vac LN	Direct-Coupled Output, standard on Models 120LSX and 320LSX
Transformer Coupled	1.5: 1	0-198 Vac LN	Models 115LSX, 160LSX, 315LSX and 360LSX equipped with Magnetics Option
		0-202 Vac LN	Models 140LSX and 345LSX equipped with Magnetics Option
	2.0: 1	0-264 Vac LN	Models 115LSX, 160LSX, 315LSX and 360LSX equipped with Magnetics Option
		0-270 Vac LN	Models 140LSX and 345LSX equipped with Magnetics Option
	2.5: 1	0-330 Vac LN	Models 115-ASX, 160-ASX, 315-ASX and 360-ASX equipped with Magnetics Option
		0-338 Vac LN	Models 140-ASX, 345-ASX, 390-ASX and 3120-ASX equipped with Magnetics Option

The 0-132<sub>LN</sub>, 0-135<sub>LN</sub>, and 0-150<sub>LN</sub> VAC output ranges are direct-coupled outputs and are always available. The remaining output voltage ranges are transformer-coupled. Only one is available when output transformers are installed. However, systems can be reconfigured for a different range, if required.

Configuration of the output voltage range is set at the time of order. Systems are configured at the factory as ordered. The System ID label or Magnetics Module ID label will state the factory configured voltage range. If the output voltage range specified on the System ID label or Magnetics Module ID label is that which is desired, no further action is required. Otherwise, reconfiguration is required and the Product ID label **must** be updated.

Configuration of the Output voltage consists of the following steps:

1. Verifying that the appropriate output transformer taps have been selected.
2. Verifying the proper setting of the Transformer Ratio Setting on the LSX controller.
3. Verifying the proper setting of the Amps to Volts Ratio Setting within the UPC
4. Calibration of the system.

Configuration varies from model to model. The following paragraphs describe the configuration settings of the available standard output ranges. Refer to the appropriate paragraph for details. When custom output transformers have been installed, refer to their Manual Addendum.

### 5.12.1 Output Voltage Configuration Model 115LSX

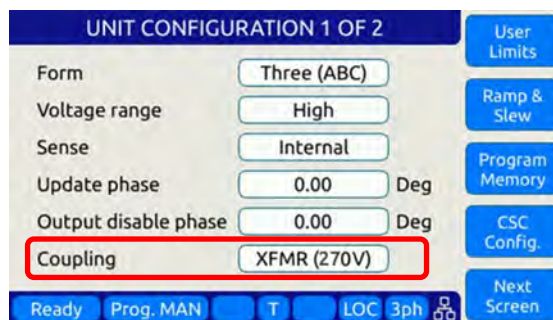
This paragraph describes the configuration of the Output Voltage Range for the Model 115-LSX Power Source. This model can be configured for either 0-132 VACI-n, 0-198 VACI-n, 0-264 VACI-n, or 0-330 VACI-n. The 0-198 VAC range is designated as the VR1.5 output form, the 0-264 VAC range is defined to be the VR2.0 output form, and the 0-330 VAC range is defined as the VR2.5 output form. An Output Transformer Assembly is required for the 198, 264, and 330 VAC output forms. Installation of the VR1.5, VR2.0, or VR2.5 output forms is performed by the factory and can be installed on existing units not so equipped.

Refer to Figure 5-7 on page 76 for voltage range tap selection information.

#### TRANSFORMER RATIO

The transformer ratio for the configure transformer is set in the UNIT CONFIGURATION 1 OF 2 screen, accessible from the CONF menu key. When the system is supplied with the VR1.5 output form, set the Transformer Ratio is set to -1 to 1.5. The Transformer Ratio setting is set to 2.0 for systems configured with the VR2.0 output form and 2.5 for systems configured for the VR2.5 output form. The Transformer Ratio setting is set to 0.0 on systems not equipped with output transformers.

The transformer ratio can also be programming using the XFMRATIO bus command.



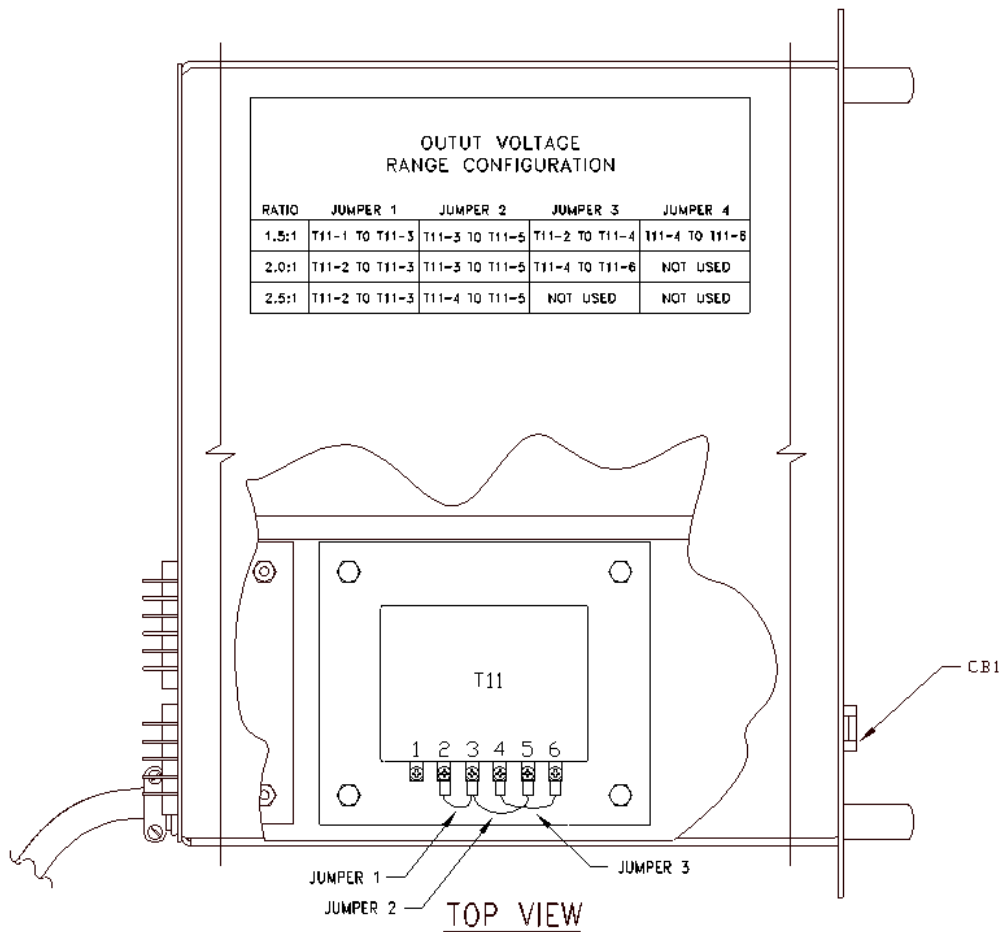


Figure 5-7: Model 115LSX Output Voltage Range Configuration Connections

### 5.12.2 Output Voltage Configuration Model 120LSX

The Output Voltage Range for the Models 120LSX and 320LSX Power Sources is 0-150 Vac LN, direct-coupled.

### 5.12.3 Output Voltage Configuration Model 315LSX

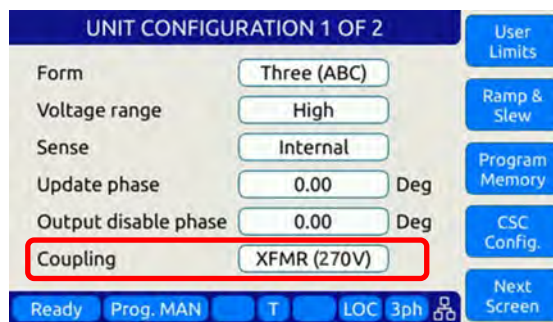
This paragraph describes the configuration of the Output Voltage Range for the Model 115-LSX Power Source. This model can be configured for either 0-132 VACI-n, 0-198 VACI-n, 0-264 VACI-n, or 0-330 VACI-n. The 0-198 VAC range is designated as the VR1.5 output form, the 0-264 VAC range is defined to be the VR2.0 output form, and the 0-330 VAC range is defined as the VR2.5 output form. An Output Transformer Assembly is required for the 198, 264, and 330 VAC output forms. Installation of the VR1.5, VR2.0, or VR2.5 output forms is performed by the factory and can be installed on existing units not so equipped.

Refer to Figure 5-8 on page 78 for voltage range tap selection information.

#### TRANSFORMER RATIO

The transformer ratio for the configure transformer is set in the UNIT CONFIGURATION 1 OF 2 screen, accessible from the CONF menu key. When the system is supplied with the VR1.5 output form, set the Transformer Ratio is set to -1 to 1.5. The Transformer Ratio setting is set to 2.0 for systems configured with the VR2.0 output form and 2.5 for systems configured for the VR2.5 output form. The Transformer Ratio setting is set to 0.0 on systems not equipped with output transformers.

The transformer ratio can also be programming using the XFMRATIO bus command.



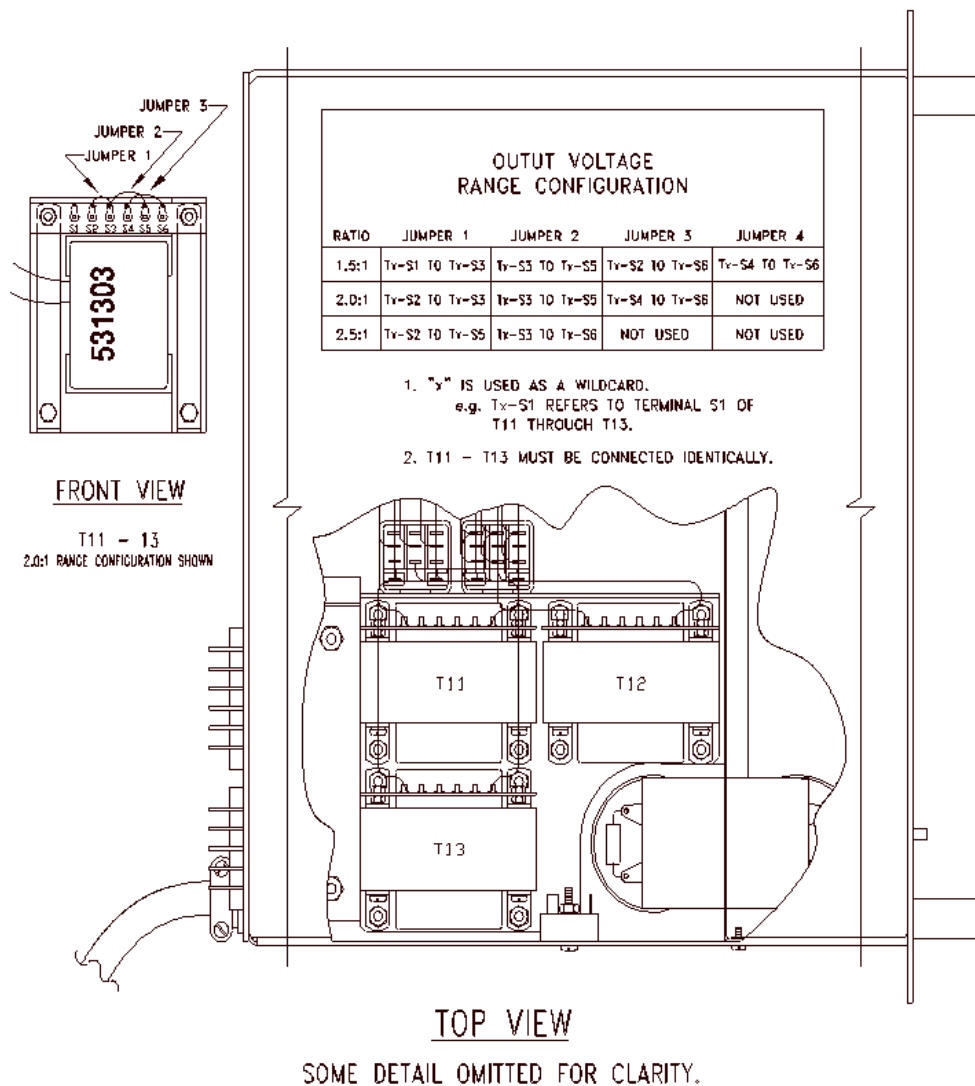


Figure 5-8: Model 315LSX Output Voltage Range Configuration Connections

### 5.12.4 Output Voltage Configuration Models 140, 160, 345 & 360LSX

For all 5U rack height LSX models, the magnetics module consists of a separate 3U rack mount chassis that contains the transformers and connects to the power source. The Magnetics Module (Assembly No. 134780) is required for the VR1.5, VR2.0, and VR2.5. Refer to Figure 5-9 on page 80.

The Output Voltage Range for Models 140, 160, 345 & 360LSXT Power Sources can be configured for either 0-135 Vac I-n, 0-202 Vac I-n defined as the VR1.5 output form, 0-270 Vac I-n defined as the VR2.0 output form or 0-338 Vac I-n defined as the VR2.5 output form.

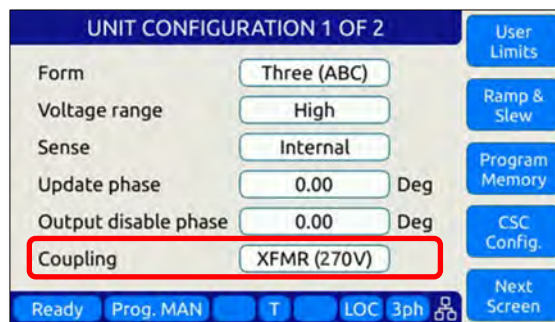
Conversion to the VR (X.X) output form is as follows:

1. Remove the top cover of the Magnetics Module.
2. The Tap Select PCB and is located in the middle of the module. See .
3. Move all jumpers to the desired transformer ratio position. All jumpers must be in the same row. The ratio is shown on the circuit board. Refer to Figure 5-10 on page 81.
4. Replace top cover of Magnetics Module.
5. Connect Magnetics Module to the power source. The Magnetics Module is connected to the power source by attaching P20 of the Magnetics Module to J20 of the power source. Also, be sure to connect the Chassis GND wire of the Magnetics Module to the CHS GND stud on the rear panel of the power source.
6. Set the Transformer Ratio Setting on the controller.
7. Calibrate the power source as stated in Section 11, “Calibration” of this manual.

## 2. TRANSFORMER RATIO

The transformer ratio for the configure transformer is set in the UNIT CONFIGURAION 1 OF 2 screen, accessible from the CONF menu key. When the system is supplied with the VR1.5 output form, set the Transformer Ratio is set to -1 to 1.5. The Transformer Ratio setting is set to 2.0 for systems configured with the VR2.0 output form and 2.5 for systems configured for the VR2.5 output form. The Transformer Ratio setting is set to 0.0 on systems not equipped with output transformers.

The transformer ratio can also be programming using the XFMRATIO bus command.



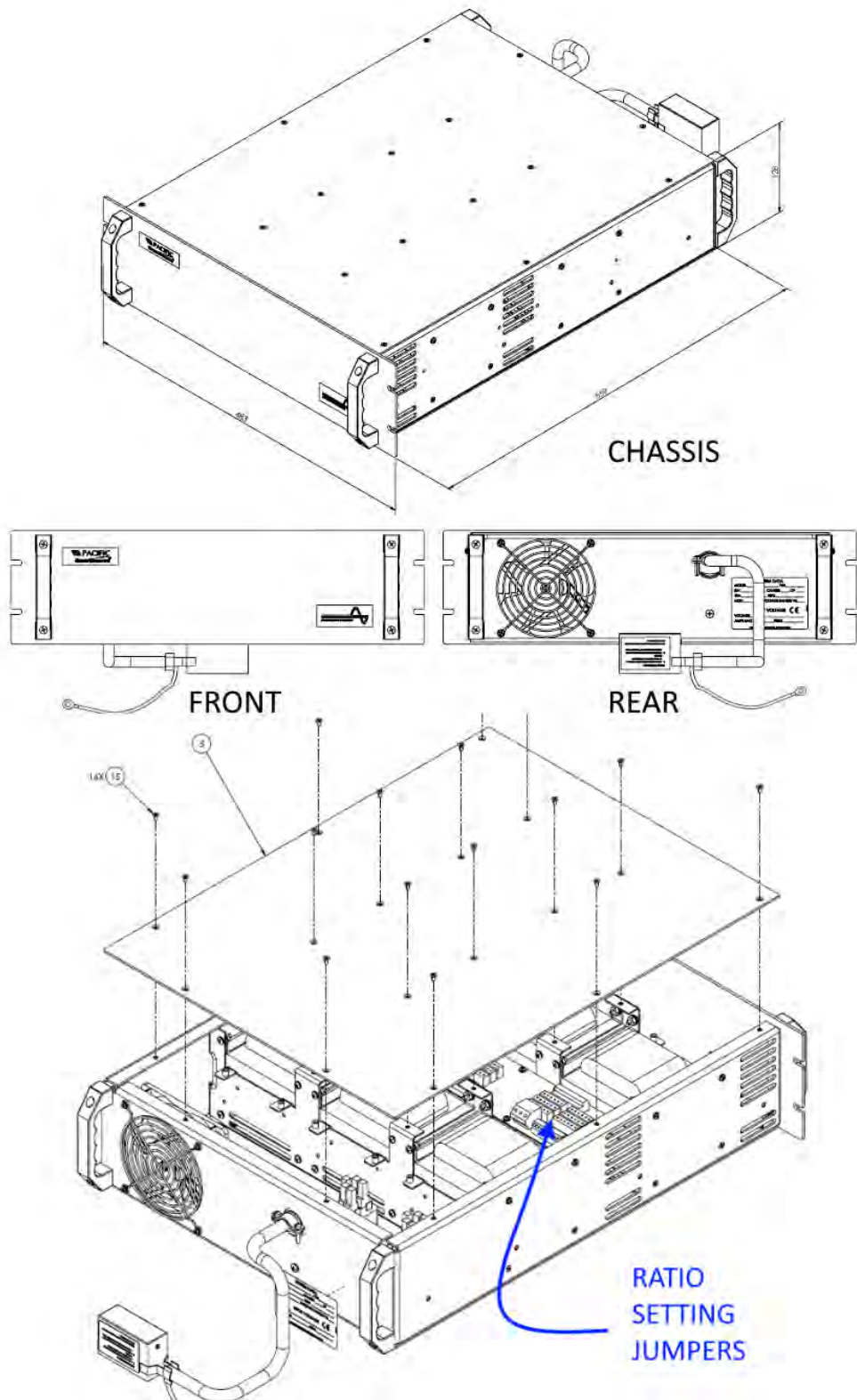


Figure 5-9: External Output Transformer Module Chassis Drawing Load Connections



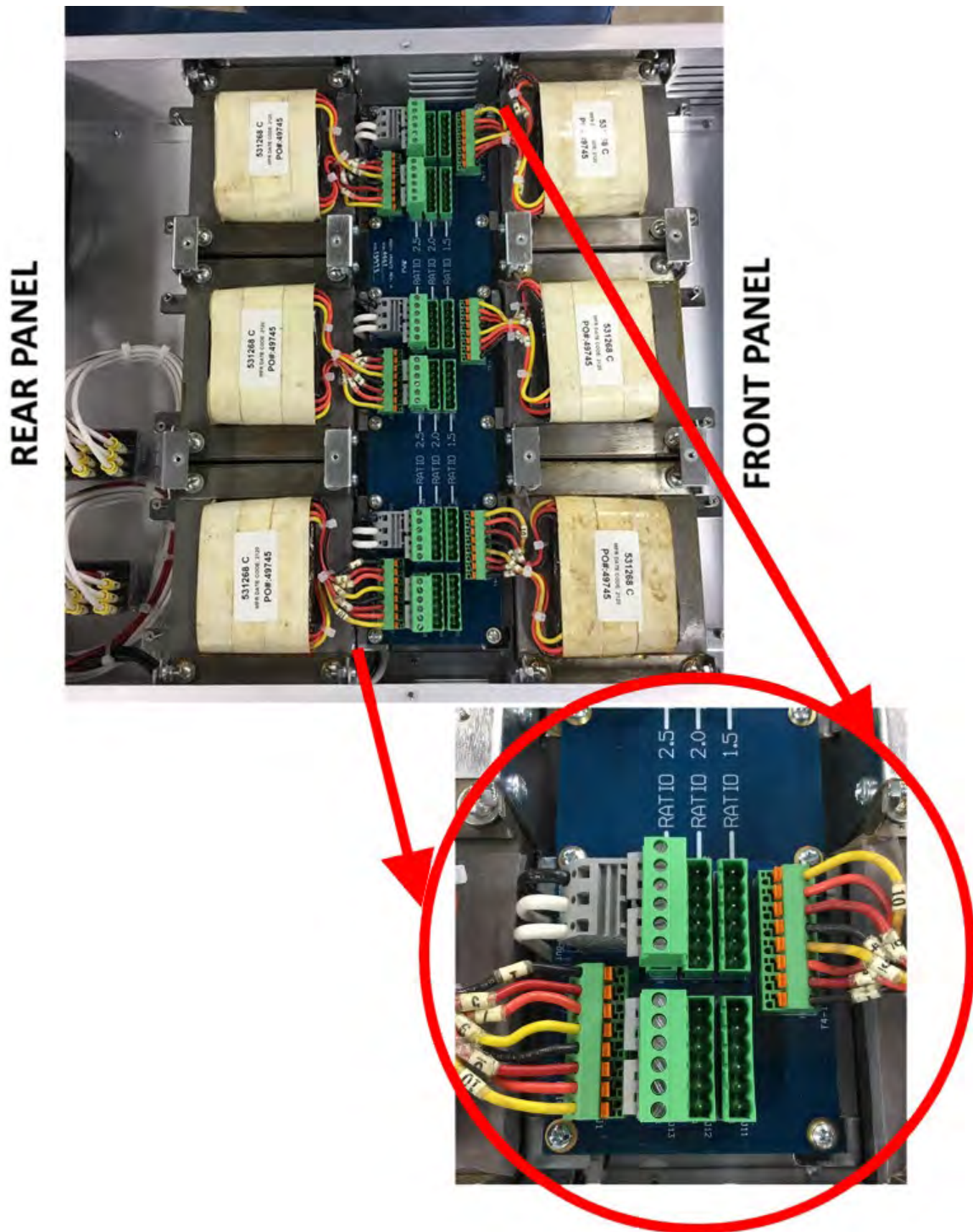


Figure 5-10: External Output Transformer Module Configuration Jumpers

## 5.13 Load Connections

**CAUTION**

HAZARDOUS OUTPUT: THE POWER SOURCE OUTPUT MAY BE SET TO HAZARDOUS VOLTAGE LEVELS. IT PROVIDES BASIC ISOLATION FROM THE AC INPUT MAINS. THEREFORE, THE OUTPUT MUST ALWAYS BE CONSIDERED HAZARDOUS. CONNECTIONS MUST BE INACCESSIBLE TO THE OPERATOR IN ALL SITUATIONS WHEN AC INPUT MAINS VOLTAGE IS APPLIED.

ALWAYS DISCONNECT POWER SUPPLY FROM THE MAINS BEFORE CONNECTING OR DISCONNECTING TO THE HAZARDOUS OUTPUT TERMINALS.

**AVERTISSEMENT**

SORTIE DANGEREUSE: LA SORTIE DE L'APPAREIL PEUT ETRE REGLEE A DES NIVEAUX DE TENSION DANGEREUX. L'APPAREIL FOURNIT UNE ISOLATION DE BASE DU RESEAU D'ENTREE AC. PAR CONSEQUENT, LA SORTIE DOIT TOUJOURS ETRE CONSIDEREE COMME DANGEREUSE. LES CONNEXIONS DOIVENT ETRE INACCESSIBLES A L'OPERATEUR DANS TOUTES LES SITUATIONS OU LA TENSION D'ENTREE SECTEUR EST APPLIQUEE.

TOUJOURS DEBRANCHER L'ALIMENTATION SECTEUR AVANT DE CONNECTER OU DECONNECTER LES BORNES DE SORTIE DANGEREUSES.

**CAUTION: USE COPPER CONDUCTOR WIRING ONLY**

Use only copper conductor (CU) wiring for all AC Input, AC Output and Ground Connections.

**ATTENTION: UTILISER UNIQUEMENT LE CÂBLAGE DU CONDUCTEUR EN CUIVRE**

Utilisez uniquement un câblage à conducteur en cuivre (CU) pour toutes les connexions d'entrée CA, de sortie CA et de mise à la terre.

### 5.13.1 Single Phase Output

The wiring requirements for a low range (0-132 Vac, 0-135 Vac or 0-150 Vac ) single phase load are shown in Figure 5-10.

The output power is taken from the terminal block located on the rear panel of the chassis labeled "OUTPUT POWER." The Output configuration is set for FORM 1 (Single Phase) when this type of load is attached.

The high side of the load is connected to the "1 $\phi$ " terminal when making connections to an LSX Series Power Source. The "N" terminal is the low side of the output. The low side of the load connects to this terminal in all models.

The "CHS" chassis ground terminal must always be connected to the chassis of the load. Since the output is isolated, either output terminal (direct-coupled output only) may be connected to chassis. This allows the user to re-establish a local ground for the output. The output must be referenced to chassis somewhere, preferably neutral. Unless demanded otherwise by a particular application, Pacific Power Source recommends that a jumper be installed across the "N" and "CHS" terminals of the Output Terminal block.

The "N" terminal of the Output Power Terminal Block must always be connected to the "CHS" terminal when using transformer-coupled outputs. Refer to Section 5.13.5 for special considerations when using transformer-coupled output forms. Refer to Section 5.13.4 for connection of the External Sense Input, when used.

**Note:** It is the user's responsibility to meet all local and national electrical codes when installing this equipment.

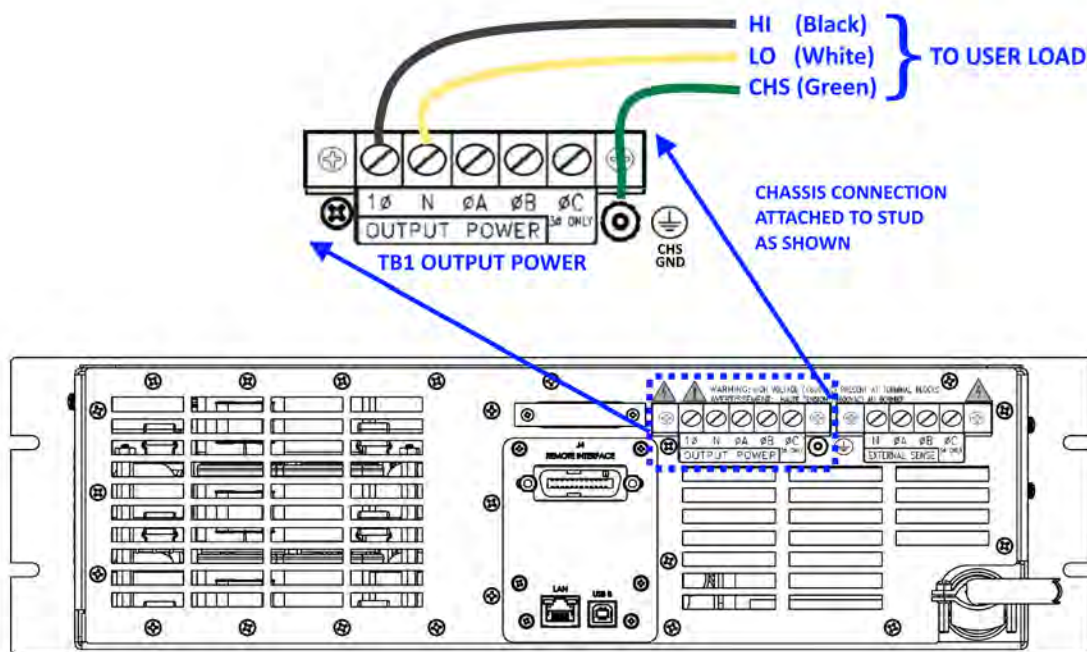


Figure 5-11: Single Phase Output Connections – 115LSX & 120LSX Models

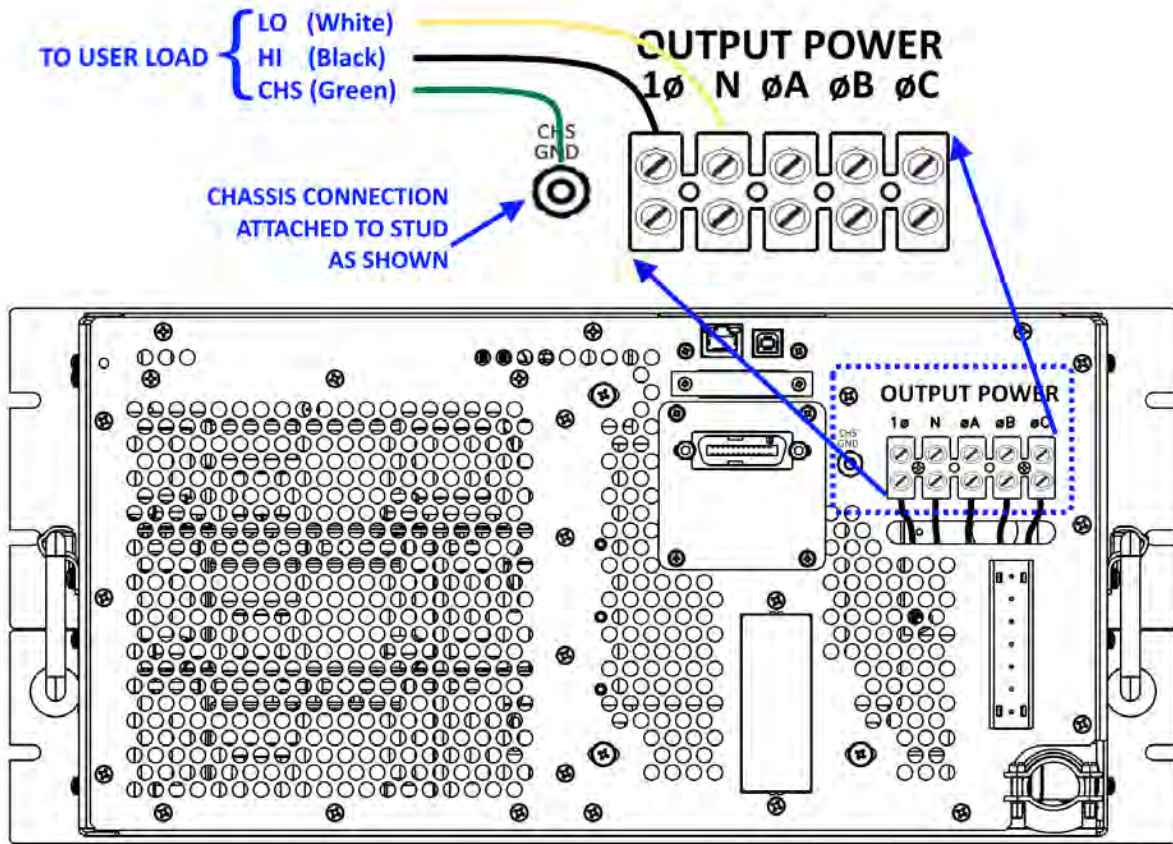


Figure 5-12: Single Phase Output Connections – 140, 160, 345 & 360LSX Models

### 5.13.2 Split Phase Output

The wiring requirements for high range (0-270 Vac, 0-300 Vac) 220 Vac, one-phase, or split phase direct-coupled loads are shown in Figure 5-8. Split Phase or two-phase operation is defined to be two voltage vectors ( $V_a$  and  $V_b$ ) which are equal in magnitude and separated by  $180^\circ$ .

The output power is taken from the terminal block located on the rear panel of the chassis labeled "OUTPUT POWER." The Output configuration is set for FORM 2 (Split phase) when this type of load is attached.

This output configuration has a direct-coupled voltage range of 0-270 Vac L-L on most LSX models (0-300 Vac L-L on 120ASX and 320LSX models) and is well-suited for driving 230 Vac single phase loads. In this case, the high side of the load is connected to the " $\phi A$ " terminal and the low side of the load to the " $\phi B$ " terminal. The "N" terminal is not used with this type of load.

Some loads require three connections ( $V_a$ -N- $V_b$  or L1-N-L2). This type of load is commonly referred to as "Split Phase". In this case, the "N" terminal of the output terminal block is

used in addition to the wiring described above. Refer to Figure 5-9 and Figure 5-10 for connection details.

The "CHS" terminal must always be connected to the chassis of the load. Since the output is isolated, any output terminal (direct-coupled output only) may be connected to chassis. This allows the user to re-establish a local ground for the output. The output (preferably Neutral) must be referenced to chassis somewhere. Unless demanded otherwise by a particular application, Pacific Power Source recommends that a jumper be installed across the "N" and "CHS" terminals of the Output Terminal block.

The "N" terminal of the Output Power Terminal Block must always be connected to the "CHS" terminal when using transformer-coupled outputs. Refer to Section 5.12.5 for special considerations when using transformer-coupled output forms. Refer to Section 5.12.4 for connection of the External Sense Input, when used.

**Note:** It is the user's responsibility to meet all local and national electrical codes when installing this equipment.

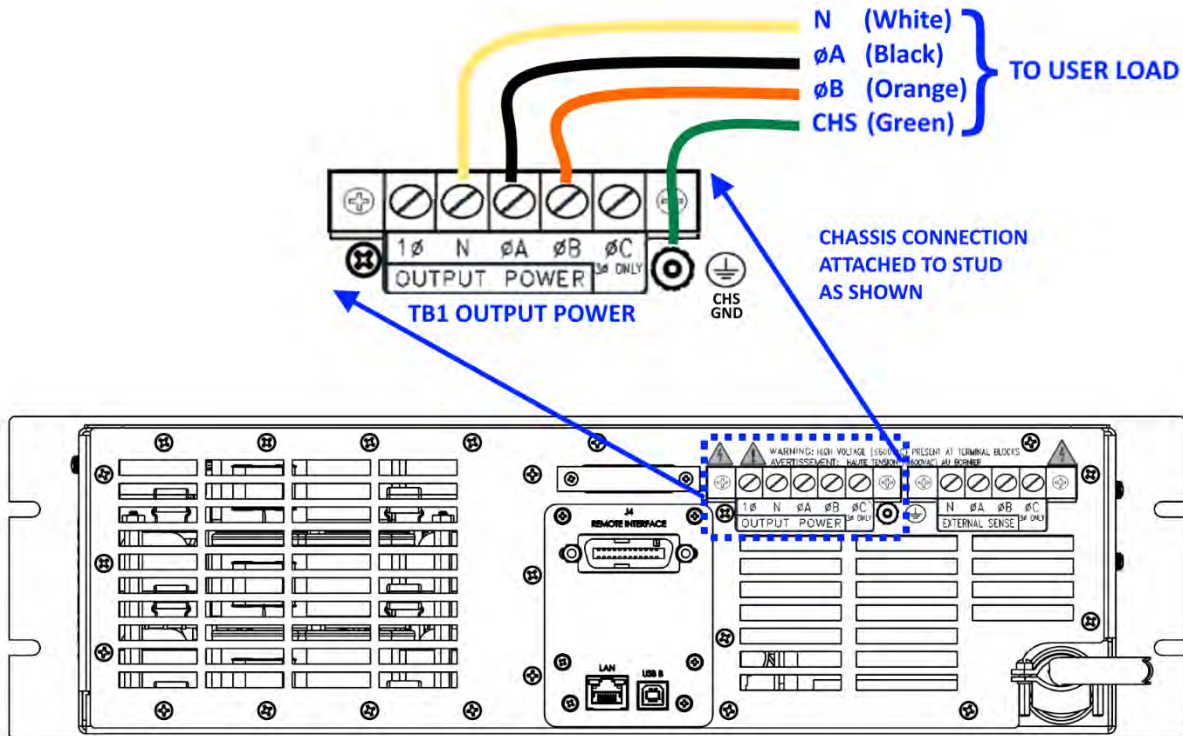


Figure 5-13: Split Phase Output Connections – 120LSX, 315LSX, & 320LSX Models

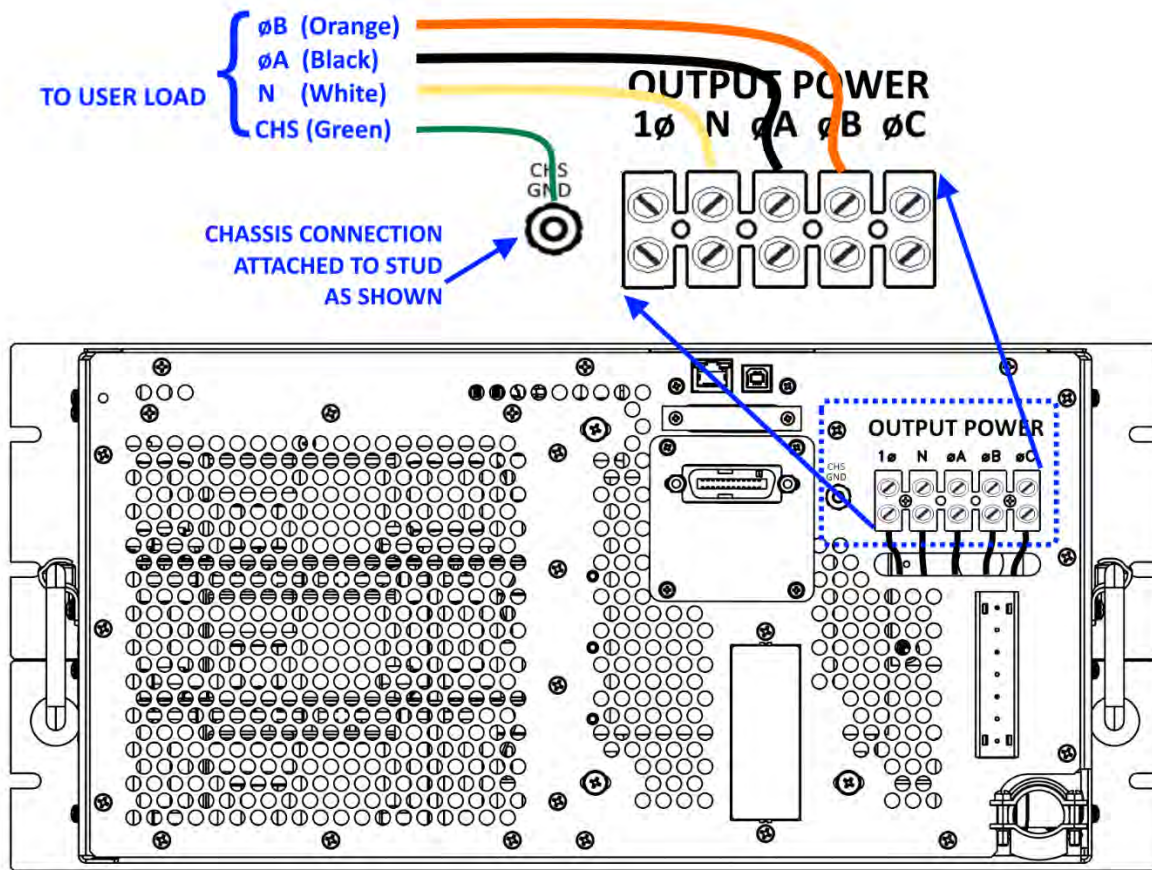


Figure 5-14: Split Phase Output Connections - 140, 160, 345 & 360LSX Models

### 5.13.3 Three Phase Output

The wiring requirements for three phase loads (WYE or DELTA) are shown in Figure 5-9.

The output power is taken from the terminal block located on the rear panel of the chassis labeled "OUTPUT POWER". This Output configuration is set for FORM 3 (Three-phase) when these types of load are connected.

This power form has a direct-coupled voltage range of 0-135 Vac L-N. WYE loads are connected to "ØA," "ØB," "ØC," and "N" terminals as shown in Figure 5-12 and Figure 5-13. In the case of DELTA loads, the "N" terminal is not used.

The "CHS" terminal must always be connected to the chassis of the load. Since the output is isolated, any output terminal (direct-coupled output only) may be connected to chassis. This allows the user to re-establish a local ground for the output. The output (preferably Neutral) must be referenced to chassis somewhere. Unless demanded otherwise by a particular application, Pacific Power Source recommends that a jumper be installed across the "N" and "CHS" terminals of the Output Terminal block.

The "N" terminal of the Output Power Terminal Block must always be connected to the "CHS" terminal when using transformer-coupled outputs. Refer to Section 5.13.5 for special considerations when using transformer-coupled output forms. Refer to Section 5.13.4 for connection of the External Sense Input, when used.

**Note:** It is the user's responsibility to meet all local and national electrical codes when installing this equipment.

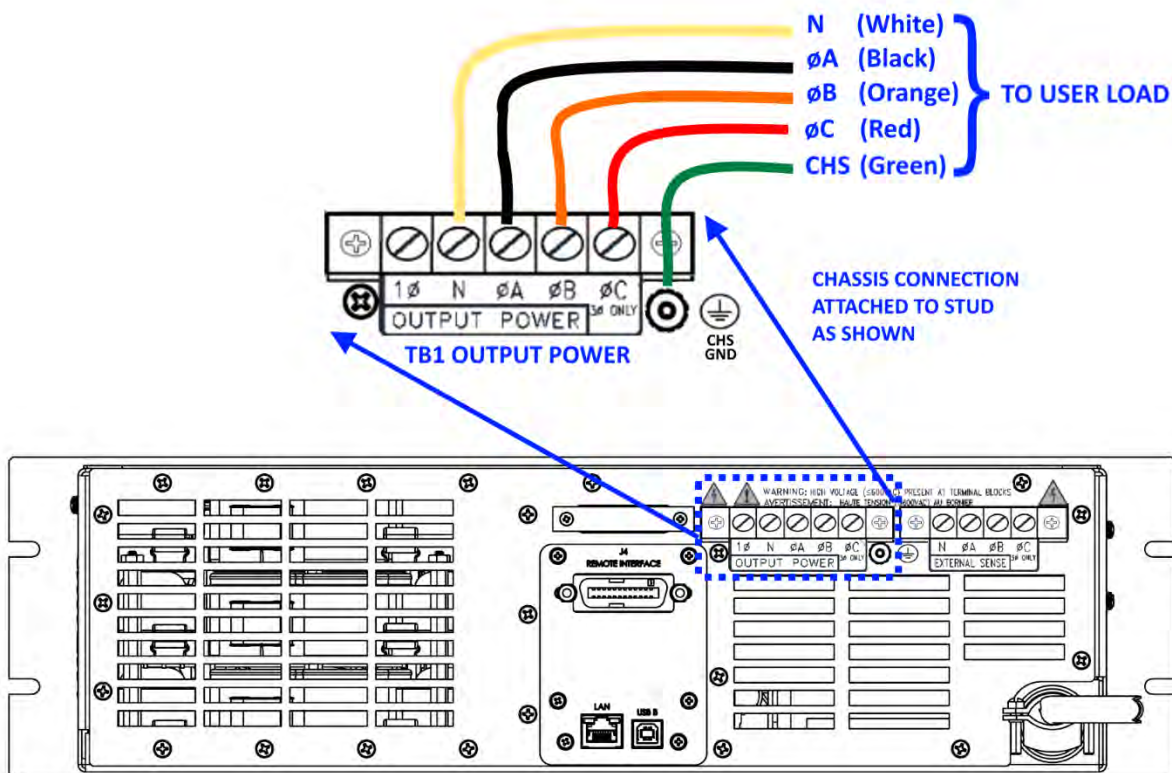


Figure 5-15: Three Phase Output Connections – 315LSX & 320LSX Models

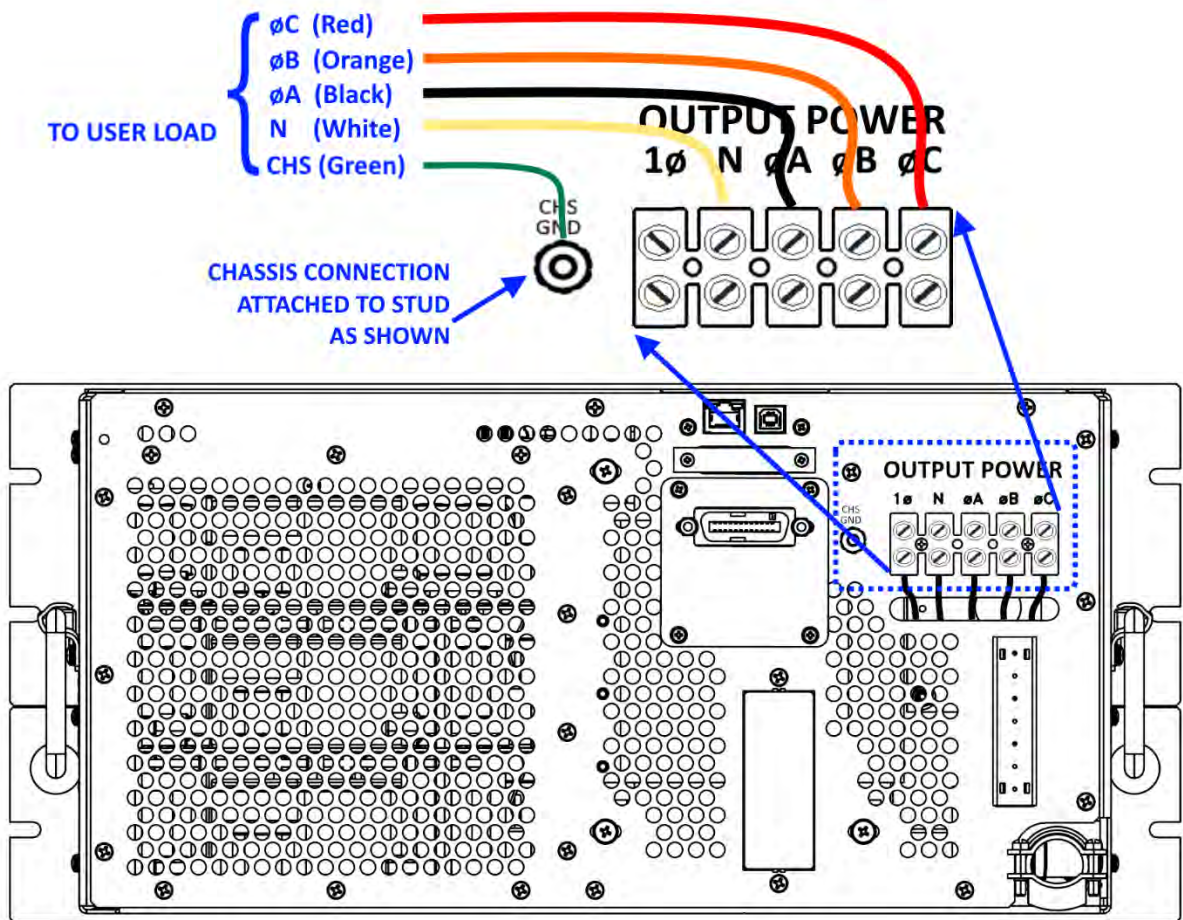


Figure 5-16: Three Phase Output Connections – 345 & 360LSX Models



## 5.13.4 External Voltage Sense Connections

**CAUTION**

**HAZARDOUS OUTPUT:** The power source output may be set to hazardous voltage levels. It provides basic isolation from the ac input mains. Therefore, the external voltage sense must also always be considered hazardous. Connections must be inaccessible to operator in all situations when ac input mains voltage is applied.

Always disconnect power supply from the mains before connecting or disconnecting to the hazardous external voltage sense terminals.

**AVERTISSEMENT**

**SORTIE DANGEREUSE:** La sortie de l'appareil peut être réglée à des niveaux de tension dangereux. L'appareil fournit une isolation de base du réseau d'entrée AC. Par conséquent, les connexions de sense externes doivent toujours être considérées comme dangereuses. Les connexions doivent être inaccessibles à l'opérateur dans toutes les situations où la tension d'entrée secteur est appliquée.

Toujours débrancher l'alimentation secteur avant de connecter ou déconnecter les bornes de connexions de sense externes.

This paragraph describes connection of external sense leads to the LSX-Series Power Source. External Sense wire size and methods are discussed.

The LSX-Series Power Source contains External Sense Circuits. These circuits measure output voltage at an external sense point. Since this feature can be completely disabled, the wiring detailed in this paragraph is optional. If the External Sense feature is desired, connect the sense wires as described here.

The Power Source contains External Sense Circuits. These circuits measure output voltage at an external sense point. Since this feature can be completely disabled, the wiring detailed in this paragraph is optional. If the External Sense feature is desired, connect the sense wires as described here.

When the external voltage sense lines are disconnected, the sensing circuit trips a sensing fault right after the protection trip time. The protection trip time is configured on the protections section and by default is 500ms. The protection is based on RMS values, so at least it takes 100ms to trip.

The protection trips if the following condition is fulfilled during a time equal to the protection trip time:

$$\text{ABS}(\text{VOLTAGE\_SETPOINT\_RMS} - \text{VOLTAGE\_MEASUREMENT\_RMS}) > \text{MAX}(\text{SENSe:FAULT:LEVel:PERCentage} * \text{VOLTAGE\_SETPOINT\_RMS}, \text{SENSe:FAULT:LEVel:MIN})$$

By default SENSE:FAULT:LEVel:PERCentage is 10% and SENSE:FAULT:LEVel:MIN is 25 volts.

Figure 5-10 shows the external sense wiring for 1, 2, and 3ϕ systems. There is little or no current flowing through the External Sense metering lines. Standard 22 AWG, 600 Volt (0.050" or 1.27mm ) control wire is recommended for this application. Twisting the External Sense wiring is recommended and, in some cases, can improve performance. In noisy environments, shielding may become necessary. If shielded cable is used, be sure to ground the shield at one end only, to prevent the possibility of creating a ground loop.

When wiring the External Sense Leads to a DELTA load, connect the Neutral terminal of the External Sense Terminal block to the Neutral terminal of the Output Terminal block.

When the neutral wire is not used by the load on a split phase output (Two-Phase Output Mode, refer to Section 0), connect the Neutral terminal of the External Sense Terminal block to the Neutral terminal of the Output Power Terminal block. In cases where the load has a neutral terminal, connect the neutral lead from External Sense Terminal block to the neutral terminal of the load.

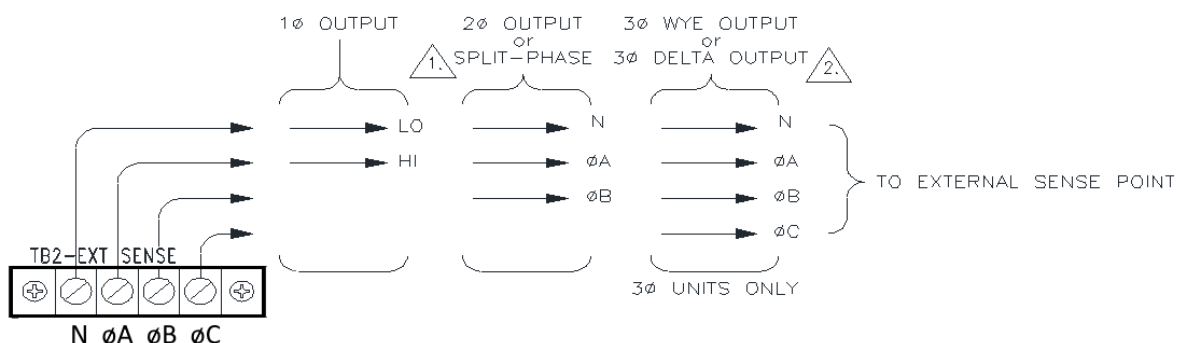


Figure 5-17: External Sense Connections – 3U Chassis Models

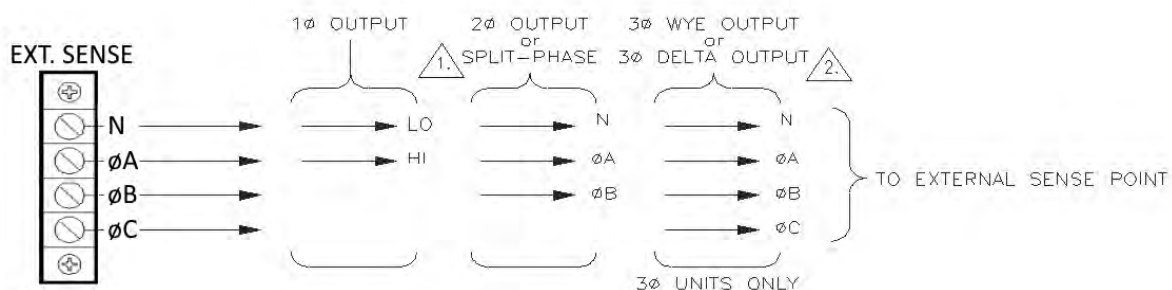


Figure 5-18: External Sense Connections – 5U Chassis Models

## 5.14 Transformer Coupled Output

### 5.14.1 Neutral Grounding



**NOTE: Importance of grounding the output neutral (N) when using Transformer coupled output.**

The output of the LSX-Series Power Source is electrically isolated from the input power and earth ground. This allows the user to establish a local ground for the output of the Power Source. The LSX-Series Power Source is designed to withstand voltage potentials of 150 Vac between the Neutral output terminal and chassis ground.

When using the direct-coupled output, any output or neutral may be connected to chassis. Since the line to neutral voltage cannot exceed 150 Vac, the voltage stress from neutral to chassis never exceeds designed limits.

In the case of transformer-coupled outputs however, neutral **MUST BE** connected to chassis ground (either locally at the power sources' rear-panel or remotely at the load), because line to neutral voltages can be greater than 150 Vac. If a phase voltage (Va, Vb, or Vc) were connected to chassis, the voltage could exceed the 150 Vac limit specified for the neutral to chassis voltage. Neutral must remain within 150 Vac of chassis (earth ground) at all times.

### 5.14.2 Low Frequency Operating in Transformer Coupled Mode

LSX-Series output transformers are designed to operate from 45 to 5,000 Hz. In the case of steady-state sine wave output, operation at frequencies as low as 30 Hz (125 Vac primary voltage) is possible.

Operation at lower frequencies - below 30Hz - may cause saturation of the output transformers, but at reduced output voltages, lower frequency operation is possible. The Volt\*Second Product of the output **MUST NOT** exceed the maximum Volt\*Second rating of the transformer to prevent saturation of the transformers when operating at lower frequencies.

For example, to determine the value of reduced voltage at 20Hz operation of the transformer described above:

1. Calculate the Volt•Second Product maximum value of the transformer at 30Hz and 125 Vac

$$T_{30Hz} = \frac{1}{Freq} = \frac{1}{30Hz} = 0.033sec \quad Volt \bullet Sec_{max} = T_{30Hz} \times V_{rms} = 0.033 \times 125 = 4.125volt \bullet sec$$

Calculate the reduced output voltage value at 20Hz with maximum Volt •Second Product value

$$T_{20Hz} = \frac{1}{Freq} = \frac{1}{20Hz} = 0.050sec \quad Volts = \frac{Volt \bullet Sec_{max}}{T_{20Hz}} = \frac{4.125volt \bullet sec}{0.050sec} = 82.5volts$$

Therefore, to prevent output transformer saturation at 20Hz operation, the maximum primary voltage of the transformer should be 82.5Vac.

Systems with transformers connected to the output require special attention when designing transient profiles (applicable to systems w/UPC). It is possible to design transients in which the DC Component of the periodic waveform is not zero. Attempting to push DC voltage through the transformer will cause saturation of the transformer. However, the output transformers are designed to support a single event, half-cycle dropout at 125 Vac primary voltage at 50 Hz without saturating. Continuous operation with an asymmetrical waveform (DC component  $\neq 0$  Vdc) will cause saturation however.

## 5.15 Powering Up

The following procedure should be followed before applying mains power:

1. Check that the front panel circuit breaker is in the OFF (O) position.
2. Verify that the model nameplate AC input specification match the local utility power.
3. Make sure that nothing is connected to any of the OUTPUT terminals on the rear panel.
4. Connect the LSX Series® AC power cord or AC input terminals to the AC mains using a suitable single or three phase AC mains disconnect switch and outlet.
5. Close the AC mains disconnect to apply utility power.
6. Turn on the front panel circuit breaker by pulling the lever upward to the “I” position.  
**Note:** Allow about 25 seconds for the LSX unit to fully initialize.
7. If the instrument does not turn on for some reason, turn OFF the front panel circuit breaker and verify the presence of the correct AC line input voltage using appropriate safety measures.

### 5.15.1 In Case of Malfunction

In the unlikely event of an instrument malfunction or if the instrument does not turn on despite the presence of the correct AC line voltage, please attach a warning tag to the instrument to identify the owner and indicate that service or repair is required. Contact Pacific Power Source or its authorized representative to arrange for service.

## 5.16 Interface Connections

There are several analog and digital interfaces on the LSX power source. This sections describes their purpose and location on the rear panel of the unit.

### 5.16.1 USB Device Interface

The USB DEVICE interface (USB Type B connector on the rear panel) provides a virtual COM port for the PC. Via this port, the unit can be controlled as a normal RS232 interface, e. g. with a terminal program or user application program. Refer to the section 9, “USB Driver Installation” for further setup and configuration information.

Refer to the section 9, “USB Driver Installation” for further setup and configuration information.

### 5.16.2 GPIB Device Interface

The GPIB interface uses the IEEE488.1 standard 24-pin D-Shell Amphenol micro ribbon connector. Using a standard GPIB cable, the cable will break out to the left of the unit when facing the rear. This will typically obstruct USB and LAN interface connector access. Reverse GPIB cables are available but using these will obstruct the Auxiliary I/O connector.


The GPIB pin assignments are per the IEEE488.1 standard and listed in the table below.

PIN	Signal	Description
Pin 1	DIO1	Data input/output bit.
Pin 2	DIO2	Data input/output bit.
Pin 3	DIO3	Data input/output bit.
Pin 4	DIO4	Data input/output bit.
Pin 5	EOI	End-or-identify.
Pin 6	DAV	Data valid.
Pin 7	NRFD	Not ready for data.
Pin 8	NDAC	Not data accepted.
Pin 9	IFC	Interface clear.
Pin 10	SRQ	Service request.
Pin 11	ATN	Attention.
Pin 12	SHIELD	
Pin 13	DIO5	Data input/output bit.
Pin 14	DIO6	Data input/output bit.
Pin 15	DIO7	Data input/output bit.
Pin 16	DIO8	Data input/output bit.
Pin 17	REN	Remote enable.
Pin 18	GND	(wire twisted with DAV)
Pin 19	GND	(wire twisted with NRFD)
Pin 20	GND	(wire twisted with NDAC)
Pin 21	GND	(wire twisted with IFC)
Pin 22	GND	(wire twisted with SRQ)
Pin 23	GND	(wire twisted with ATN)
Pin 24	Logic ground	


Table 5-2: GPIB Interface Connector Pin Assignments

### 5.16.3 LAN Interface

The LAN interface connector is installed on the rear panel. The MAC address of the unit can be found near the LAN connector.



## CAUTION

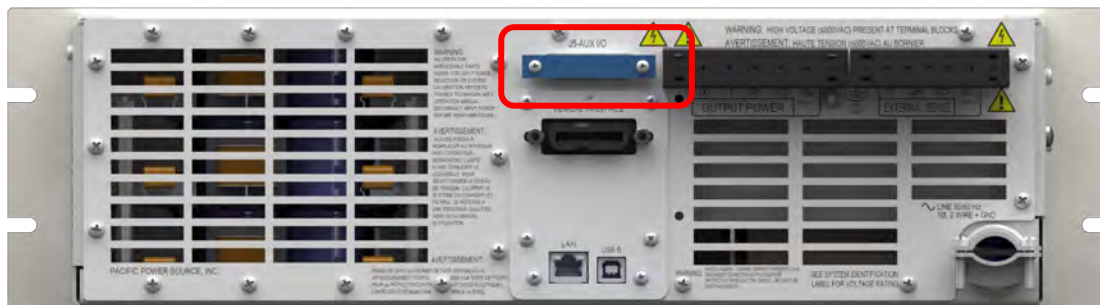


**Do NOT connect the RJ45 LAN (Ethernet) connector of the power source to a PoE (Power over Ethernet) port as the DC voltage will damage the LAN interface.**

No special device drivers are required to use the LAN interface as it uses TCP/IP protocol but the IP address needs to be configured to operate on the user's local area network or private network.

### 5.16.4 Auxiliary I/O Connections

The AUX I/O connector contains synchronizing outputs (digital) and modulation inputs (analog). These are extremely useful in certain test applications. The use of any of these signals is optional and connection to these points is required only when these features are used.



**Note:** When not in use however, make sure than any analog or digital programming inputs are disabled on the controller or any noise picked up by these inputs may interfere with programming from the front panel or digital interfaces.

The AUX I/O connector is located on the rear panel of the power source and is labeled as such. This is a DB-25S Female connector. A DB-25P Male connector is required for connection to AUX I/O connector.

All signals contained within the AUX I/O connector are low-level (less than  $\pm 12$  VDC) and are with respect to earth ground reference. Refer to the appropriate controller operation manual for complete definition of the signals present on the AUX I/O connector.

For detailed information on AUX I/O signals and use, refer to Section 7 on page 184.

## 6 Front Panel Operation

This Chapter provides an overview of front panel operation for the LSX Series® AC power sources. For remote control operation, refer to Section 8 “Remote Control Programming” of this manual for an overview of available programming commands.

### 6.1 Front Panel Layout

The front panel layout is shown in Figure 6-1 below. The number of buttons is kept to a minimum to ensure simple front panel operation for casual and experienced users alike. The shuttle knob is used to slew parameter values and move through menus to make selections.

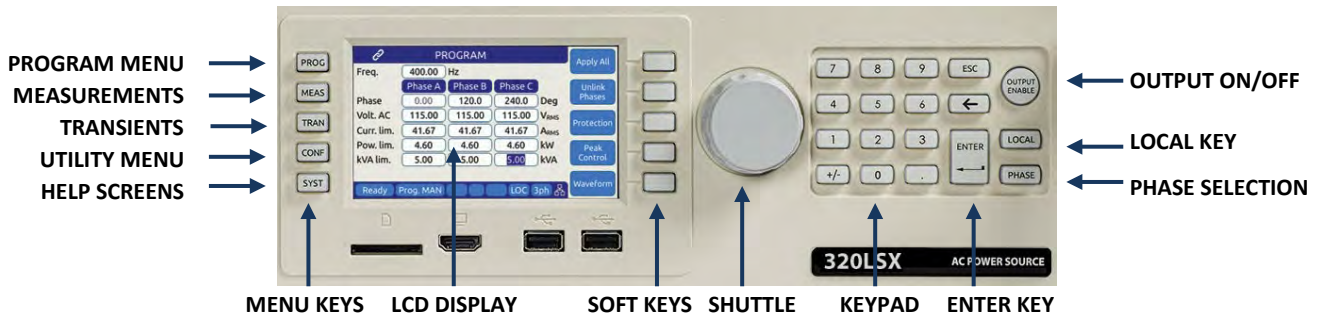


Figure 6-1: LSX Series® Front Panel View

A large backlit LCD display is located in the center. Most user controls are located directly to the right of the display. The power ON/OFF circuit breaker is located towards the left of the front panel.

### 6.1.1 Keyboard Buttons

There are several groupings of push buttons that make up the front panel. They are grouped as follows:



Group	Function
<b>Menu Selection Keys</b>	These keys select the available top-level menus. Sub menus may be accessible using any of the available soft keys within each top-level menu.
<b>Soft Keys</b>	Soft keys change function as indicated by the decal directly to the left of the soft key on the LCD display.
<b>Shuttle</b>	See next section for details on shuttle operation.
<b>Decimal Key Pad</b>	The decimal key pad is used to enter parameter values directly. Values may also be set using any available soft key or the shuttle.
<b>ENTER Key</b>	The <b>ENTER</b> key confirms a selection or setting made with the decimal key pad. Until confirmed by pressing the ENTER key, selections and values will be shown grayed out on the LCD display to indicate they have been edited/changed but have not yet taken effect. This allows multiple parameters in the same screen to be edited with all new setting values taking effect at once when the ENTER or UPDATE ALL soft key is pressed.
<b>ESC Key</b>	The escape key backs out of a menu or selection and returns to a previous level.
<b>Back Space Key ( ← )</b>	This key backs up one position erasing the last digit value entered.
<b>OUTPUT ENABLE</b>	The <b>OUTPUT ENABLE</b> key is used to toggle the output on or off. If the output is ON, this key will be lit.
<b>LOCAL</b>	Returns the instrument to local control mode allowing front panel operation. This key may be disabled over one of the remote control interfaces. While in REMOTE, the keyboard is locked out. The <b>LOCAL</b> key can also be used to capture and LCD Image and store it as an .png image file in internal memory. To do so press and hold the LOCAL key, then press the 1 key. Screen images are saved in folder "internal/screenshots".
<b>PHASE</b>	The <b>PHASE</b> key is used to select a specific phase on three phase LSX —models. On single phase LSX models, the selected phase is always A and this key has no function.



### 6.1.2 Shuttle Knob

The shuttle knob or rotary digital encoder is used to navigate (scroll) through menus and select fields to modify settings. The shuttle knob also includes a SELECT push button function. Pushing in the shuttle knob (SELECT) while on a data field will allow the value to be slewed up or down.

NOTE: Unlike when using the decimal keypad to enter a value, the SELECT shuttle mode will cause the output to change immediately. This allows slewing of the actual output value.

Once the final value is reached, pressing the shuttle again will take it out of slew mode and back into scroll mode.

### 6.1.3 PC Monitor Output

A PC monitor output connector is located on the front panel's left side. This connector is marked with a monitor icon as shown here. This allows connection of a computer monitor. When connected, the monitor will display the information otherwise shown on the front panel LCD screen and the LCD screen itself will be off.



This feature allows for the connection of a touch enabled LCD monitor to the Video Output the front panel as well. When detected by the LSX, a message will pop-up asking the operator to change to the external screen. If accepted, the front panel LCD will turn off and the LSX screen will be display on the monitor along with a touch panel to operate the unit. The actual front panel keypad will remain active as well. This feature is useful for operator training or in control rooms where being able to read the measurement screen from across the room is required. A USB connection to one of the LSX USB ports is required to use the monitor's touch feature.

To return the display to the LCD screen, unplug the monitor.

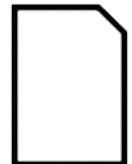
### 6.1.4 USB Host Ports

Two USB host ports are located on the left hand side of the front panel. These ports will accept a USB memory device or a USB peripheral such as a mouse or keyboard<sup>14</sup>. These USB ports are marked with the standard USB symbol as shown here.



### 6.1.5 SD Card Memory Slot

A SD Card memory device slot is located on the left hand side of the front panel. This slot will accept a standard SD memory card. The SD Card slot is marked with the symbol shown to the right here.



<sup>14</sup> Note: Not all device types and brands are supported.

## 6.2 OUTPUT ENABLE Button

The circular Output Enable (On/Off) button is located on the right hand side of the front panel keypad. Its unique circular shape makes it easy to find so the output can be turned off quickly if needed.

### 6.2.1 OUTPUT State Indication

The state of the output is indicated by the back light color of the Output On/Off button. A blue color indicates the output is OFF, a green color indicates the output is ON.

### 6.2.2 Output On Response Times

Turning the output ON means that any power stage that was disabled for energy conservation purposes will be started and allowed to settle. This includes the output inverters. Once all power stages are up and running, the output relays are closed and whatever programmed output mode, voltage and frequency will be applied to the load. If all stages were off – power source in sleep mode – this process can take up to 2.2 seconds. If the output control mode is set to FAST mode however, only the inverters are ever turned off and output can be applied within 200 msec, which is typical for older design power source with no energy saving features or sleep mode capability.

## 6.3 Menu Keys

The various menus and settings available to the user from the front panel are detailed in this section of the manual.

All available menus can be accessed using the Menu keys to the left of the LCD display. The following five keys are available.

MENU KEY	MENU SCREEN	Description
<b>PROG</b>	PROGRAM	Programming of output parameters and Measurements read back
<b>MEAS</b>	MEASUREMENTS	Measurements
<b>TRAN</b>	TRANSIENTS	Transient Programming and Execution
<b>CONF</b>	CONFIGURATION	Configuration Screens
<b>SYST</b>	SYSTEM	System Settings, Interface Configuration and Calibration

*Table 6-1: Available Menu Keys*

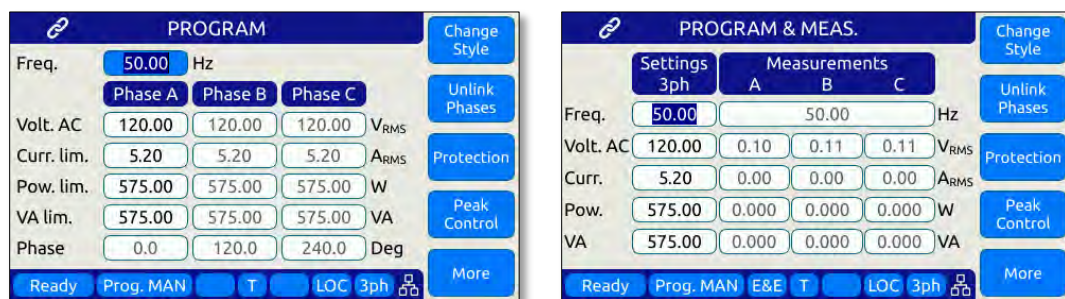
Following sections cover each aspect of the front panel screen and parameters in more detail.

## 6.4 PROG – PROGRAM & MEASUREMENTS Screen

There are two available PROGRAM screen types:

- PROGRAM – Displays output settings for all phases and allows individual phase programming. No measurements are visible on this program screen.
- PROGRAM & MEASUREMENT – Combines programming of voltage, current and power output settings with measurements for all available phase. Frequency changes cannot be made from this program screen.

Either screen can be used to program the output and toggling between screens is done by pressing the “Change Style” soft key (SK1).



Output parameters can set from the PROGRAM screen or the PROGRAM & MEASUREMENTS screen. Each setup parameter can be changed by highlighting the field and either slewing the value using the shuttle knob or entering a value using the numeric key pad. The difference between these two data entry modes is that slewing causes the output to change as the knob is turned while using the keypad allows one or more parameters to be preset to a new value which won’t become active until the “Apply All” soft key or the ENTER key is pressed.

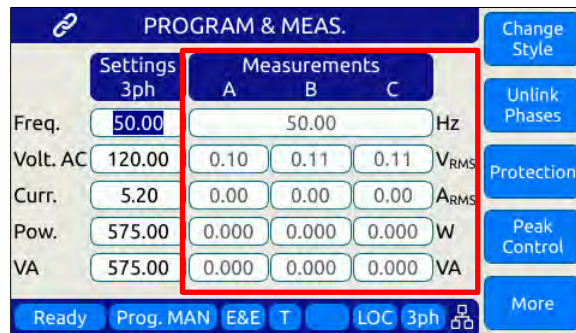
Thus to slew a value, proceed as follows:

1. Use shuttle to move the active field to the parameter you want to slew.
2. Press the shuttle once to enter the slew mode. The selected field will be highlighted.



3. Use the shuttle to increment (*clockwise*) or decrement (*counterclockwise*) the selected parameter. Note that these changes take effect immediately resulting in the active output slewing up or down.
4. To set commonly used standard AC voltage values, the preset value soft keys shown in the screen above may be used as well to directly set a pre-defined value. The settings for these pre-set soft keys can be changed from factory defaults shown here as needed.

**Note:** This assumes the output is ON. If the output is OFF, the new value will be in effect and apply at the output as soon as the output is turned ON.



Measurements can be seen on same screen so any changes made to output settings will be reflecting in the measurement read-back portion of this screen.

To change one or more values but not change the actual output till all parameters are preset, proceed as follows:

1. Use shuttle to move the selected field to the parameter you want to change.
2. With the parameter field selected, enter a new value using the numeric keypad. Note that all fields are now shown with a gray background (Edit mode active)
3. Once satisfied with the new value, move to the next parameter you want to change.
4. Once all values are set to the new desired set value, press the ENTER key or the “Apply All” soft key.

#### 6.4.1 Power On Settings

The LSX Series will normally power up with the last settings in effect at turn-off.

This behavior is determined by the the “SOURce:INITial” command. This feature is active by default. This makes the LSX “remember” all the settings after cycling power.

This mode can be disabled by using the remote control command:

SOURce:INITial 0

This setting is retained in non-volatile (FLASH) memory. For set points affected, refer to Section 8.7.1, “Source Configuration Programming Commands” on page 257.

### 6.4.2 PROGRAM Output Parameters



Figure 6-2: PROGRAM Screen

The two data entry methods described apply to the parameters on the PROGRAM & MEASUREMENTS screen. This includes those shown in the table below.

PARAMETER	Range	Unit	Description
Frequency	15 - 1200 <sup>1</sup>	Hz	Output frequency
Voltage AC	0 – 300 <sup>1</sup>	V rms	AC output
Current limit	0 to Max	A rms	RMS Current Limit
Power limit	0 to Max	W	True Power Limit
kVA limit	0 to Max	VA	Apparent Power Limit

Table 6-2: Available Output Parameters on PROGRAM screen

**Note 1:** Range may differ for models with Transformer (T) Option.

Each screen has up to five soft keys on the right hand side of the display. These may change as the selected parameter changes. To move between parameter fields in any screen, use the shuttle knob. To change a parameter, press the shuttle knob and then adjust the value by turning the shuttle. When done, press the shuttle to exit edit mode.

### 6.4.3 Phase Rotation / Phase Sequence

Phase rotation(aka sequence) in three-phase mode is fixed. The default phase rotation of the LSX is the same as that of legacy PPS UPC controllers.

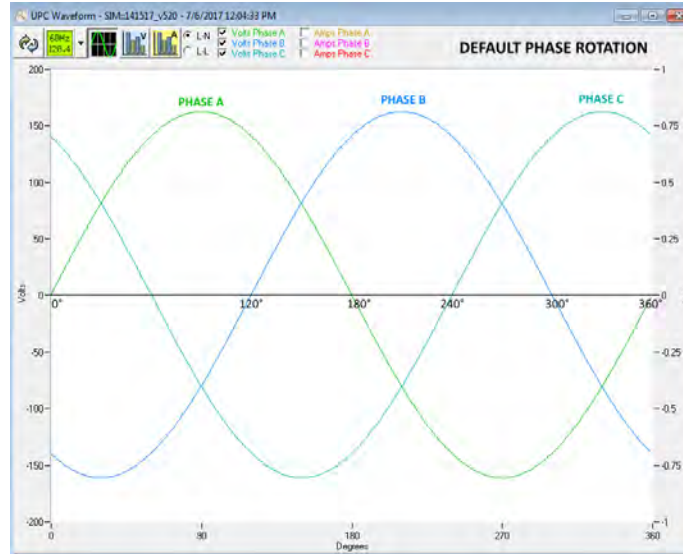


Figure 6-3: Three Phase AC mode Default Phase Rotation

Phase rotation in three-phase mode can be reversed if needed by swapping output connection wires B and C to the load.

The reversed phase rotation is shown in the figure below for reference.

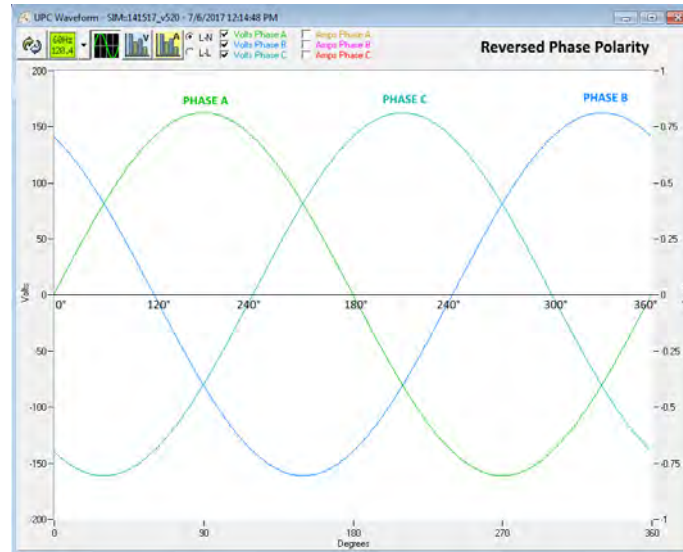


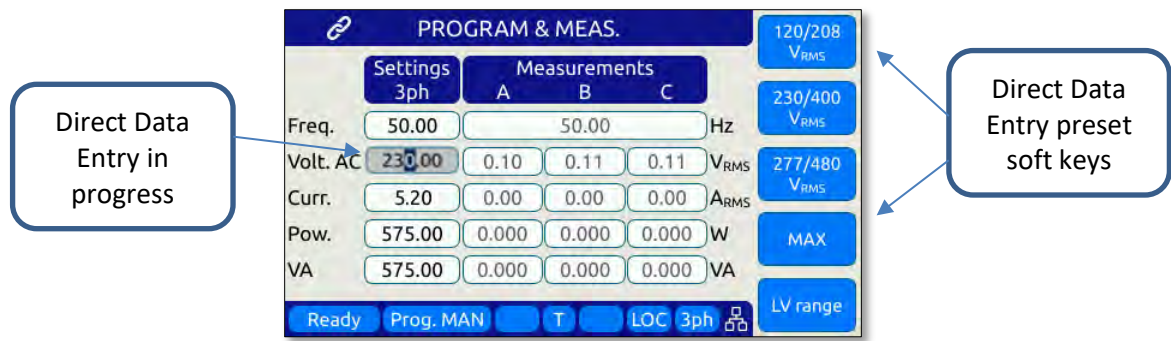
Figure 6-4: Three Phase AC mode Reversed Phase Rotation

#### 6.4.4 Direct Data Entry - Presets

Values for Frequency, Voltage, Current, Phase and Power can be entered directly using the numeric keypad. Position the flashing cursor on the field for which you want to enter a new setting value. Once a field is selected, press the first key of the value you want.

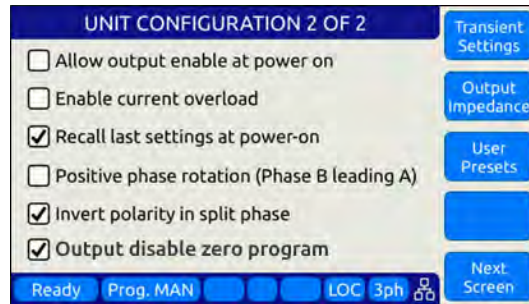
As soon as you enter the first digit, the soft keys will display commonly used values for the parameter you are changing. For example, if you are on the Frequency fields, presets for 50 Hz, 60 Hz, 400 Hz, 800Hz and 1200Hz will appear.

If you are on the Voltage AC field, voltage presets for single phase (on single phase LSX models) or LN and LL voltage preset soft keys will appear. A Low Voltage Range selection will be offered as well allowing you to lock in the virtual low range, which limits AC voltage entry to no more than 150 Vac. This is illustrated on the image below.



### 6.4.5 Customizing Output Programming Preset Soft Key Values

The power source allows the user to set up his own preferred or often used output programming values in place of the factory default selections. This can be done from the SYST menu by selecting the UNIT CONFIGURATION 2 OF 2 screen and pressing the “User Presets” soft key.



For details on changing available pre-set soft key values, refer to section 6.4.5, “Customizing Output Programming Preset Soft Key Values” on page 104.

### 6.4.6 Changing Shuttle Programming Resolution

Once entering EDIT mode on any programmable field – by double clicking the shuttle knob – the parameter value can be slewed by turning the knob. The setting resolution can be changed as needed. If a large value change is needed, a lower resolution will result in a faster change, e.g. changing voltage 10V per click or 1V per click. For a very small change, a 0.1V or 0.01V change per click may be more appropriate.

The selected resolution is reflected by the blinking character when in edit slew mode. To change the position and thus resolution, use the keypad numeric keys. The lowest number keys will select the smallest increment/decrement setting. The higher number keys will select a larger increment/decrement setting.

The table bellows maps the keypad keys to the resolution setting.

Key Pad Key #	Position	Resolution
1 or 2	0.00	0.01
3	0.00	0.1
4	0.00	1
5	0.00	10
6, 7, 8 or 9	00.00	100
7, 8, 9	000.00	1000

Table 6-3: Changing Programming Resolution



### 6.4.7 PROGRAM & MEASUREMENTS Soft Keys



The following five soft keys are available on the main PROGRAM screen.

SOFT KEY	Description
<b>Change Style (SK1)</b>	Toggles between PROGRAM only setup screen or PROGRAM & MEAS style setup screen
<b>Unlink Phases (SK2)</b>	Toggle between Linked and Unlinked Phases data entry mode for settings

SOFT KEY	Description						
<p><b>Protection Screen 1 (SK3)</b></p>	<p>Displays the POWER AND CURRENT PROTECTIONS screen shown below.</p> <div data-bbox="706 378 1282 703" style="border: 1px solid black; padding: 5px; margin: 10px auto; width: fit-content;"> </div> <p>There are two check box options and one data field on this screen that can be set as needed:</p> <table border="0" style="width: 100%;"> <tr> <td style="width: 50%;">Enable RMS current protection</td> <td>Activates the programmable current limit function at the value set in the main program screen</td> </tr> <tr> <td>Enable power protection</td> <td>Activates power protection at W and kVA set points.</td> </tr> <tr> <td>Trip time:</td> <td>Determines how long the power source will allow the power level setting to be exceeded before tripping off.</td> </tr> </table>	Enable RMS current protection	Activates the programmable current limit function at the value set in the main program screen	Enable power protection	Activates power protection at W and kVA set points.	Trip time:	Determines how long the power source will allow the power level setting to be exceeded before tripping off.
Enable RMS current protection	Activates the programmable current limit function at the value set in the main program screen						
Enable power protection	Activates power protection at W and kVA set points.						
Trip time:	Determines how long the power source will allow the power level setting to be exceeded before tripping off.						
<p><b>Peak Control Screen 1 (SK4)</b></p>	<p>Displays the PEAK CURRENT protection setup screen.</p> <div data-bbox="706 1207 1282 1533" style="border: 1px solid black; padding: 5px; margin: 10px auto; width: fit-content;"> </div> <table border="0" style="width: 100%;"> <tr> <td style="width: 50%;">Peak current protection</td> <td>Enables or disables user programmable peak current control level.</td> </tr> <tr> <td>OVP Margin</td> <td>User programmable OVP level.</td> </tr> </table>	Peak current protection	Enables or disables user programmable peak current control level.	OVP Margin	User programmable OVP level.		
Peak current protection	Enables or disables user programmable peak current control level.						
OVP Margin	User programmable OVP level.						

SOFT KEY	Description
<b>Waveform Screen 2 (SK3)</b>	Displays the user waveform selection screen including a preview of the selected waveform.
<b>Interharmonic Screen 2 (SK4)</b>	Displays the interharmonics program screen. Set the frequency (any value, unrelated to the fundamental frequency that is programmed), interharmonic voltage level in $V_{RMS}$ and the interharmonics phase shift with respect to Phase A.

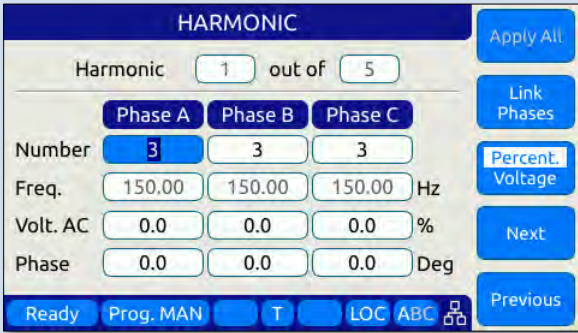
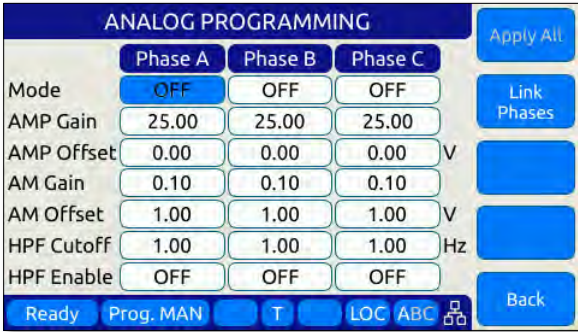
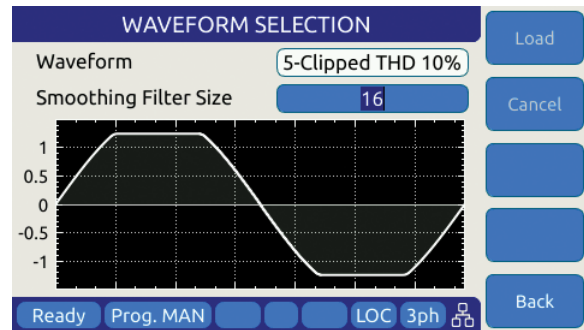
SOFT KEY	Description
<b>Harmonics Screen 3 (SK3)</b>	<p>Displays the harmonic program screen. Set the harmonic number (integer multiple of the fundamental frequency that is programmed), harmonic voltage level in Vrms and the interharmonics phase shift with respect to Phase A. Amplitude can be set in Percent or absolute Voltage. There are 5 harmonic amplitude control loops Number 1 through 5 available. Use the Next software to toggle through the 5 settings as needed.</p> 
<b>Analog Prog. Screen 3 (SK4)</b>	<p>Displays the Analog Programming settings for the Auxiliary I/O functions.</p> 
<b>More (SK5)</b>	<p>The More softkey toggles through the three available PROGRAM or PROGRAM &amp; MEAS. Setup screens in a cyclical way.</p>

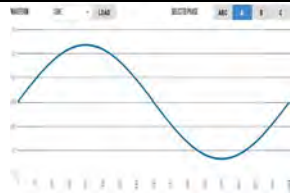
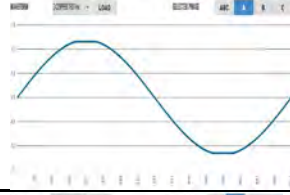
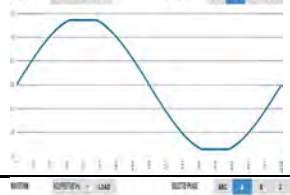
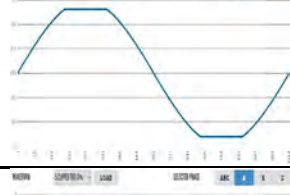

Table 6-4: PROGRAM screen soft keys

### 6.4.8 Available Waveforms

The LSX Series® is supplied with 10 pre-loaded waveforms but can hold a total of 200. The default content of the first 10 registers are shown in the table below. Also shown are the waveform number names and the waveform description each waveform.

For waveforms with high harmonic content – e.g. sharp transition or fast edges – the smoothing filter feature can be used to smooth out these high frequency events to reduce over/undershoot as needed. The value entered indicates the number of waveform data points that will be averaged to obtain a smoother wave shape. Preview of the resulting smoothed waveform is shown on the LCD screen.



Name	Description	Image	Notes
1	SINE		Standard sine wave. No harmonic content <sup>1</sup> . This is also the default selected waveform at power on unless a power-on setup is recalled. <b>Waveform 1 is fixed and CANNOT be changed!</b> Note 1: See SOURce:WAVEFORM:SINEwave command
2	CLIPPED THD 1%		Clipped sine with 1% total harmonic voltage distortion due to flat topping of sinewave peaks.
3	CLIPPED THD 2%		Clipped sine with 2% total harmonic voltage distortion due to flat topping of sinewave peaks.
4	CLIPPED THD 5%		Clipped sine with 5% total harmonic voltage distortion due to flat topping of sinewave peaks.
5	CLIPPED THD 10%		Clipped sine with 10% total harmonic voltage distortion due to flat topping of sinewave peaks.



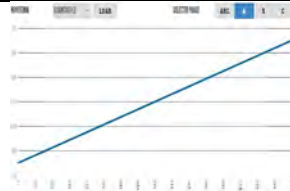
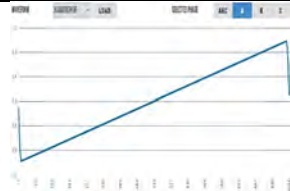
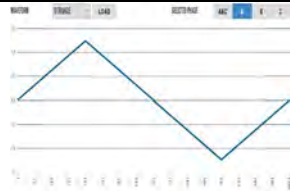
Name	Description	Image	Notes
6	SQUARE LF		Square wave. Consists of fundamental and all odd harmonics. The LF (low frequency) version is recommended for use below 100Hz.
7	SQUARE HF		Square wave. Consists of fundamental and all odd harmonics. The HF (high frequency) version is recommended for use above 100Hz.
8	SAWTOOTH LF		Saw tooth. Consist of fundamental and both odd and even harmonics. Note: Not recommended for conventional power applications. LF use < 100Hz.
9	SAWTOOTH HF		Saw tooth. Consist of fundamental and both odd and even harmonics. Note: <b>Non-linear!</b> Not recommended for conventional power applications. HF use > 100Hz.
10	TRIANGLE		Triangle. Similar to saw tooth but at same fundamental as a sine wave. Contains fundamental and odd harmonics with amplitudes that roll off as the inverse square of the harmonic number. (1/3, 1/9, 1/25 etc.).
11 ~ 200	User Defined		Waveforms 17 through 200 can be added as needed.

Table 6-5: Available Included LSX Series® Waveforms

### 6.4.9 Waveform Smoothing Filter

User defined or arbitrary waveforms can contain sudden transients, which equates to high order harmonics. Such types of waveforms can result in over or undershoot when applied at higher frequencies (i.e. 400Hz to 800Hz). An extreme example of this is a pure square wave, which would require infinite output bandwidth to accurately reproduce.

To mitigate this effect, the LSX Series® offers a smoothing filter feature (*FW rev 1.3.3. or higher required*) that may be used to smooth these transient. This filter using a moving average method over 1 to 101 samples to reduce the slew rates of these abrupt transitions. A value of 1 represents Disabled (default setting) so no smoothing takes place.

The two samples below show the same square waveform with no smoothing (disabled) and smoothing over 100 waveform data points (max.).

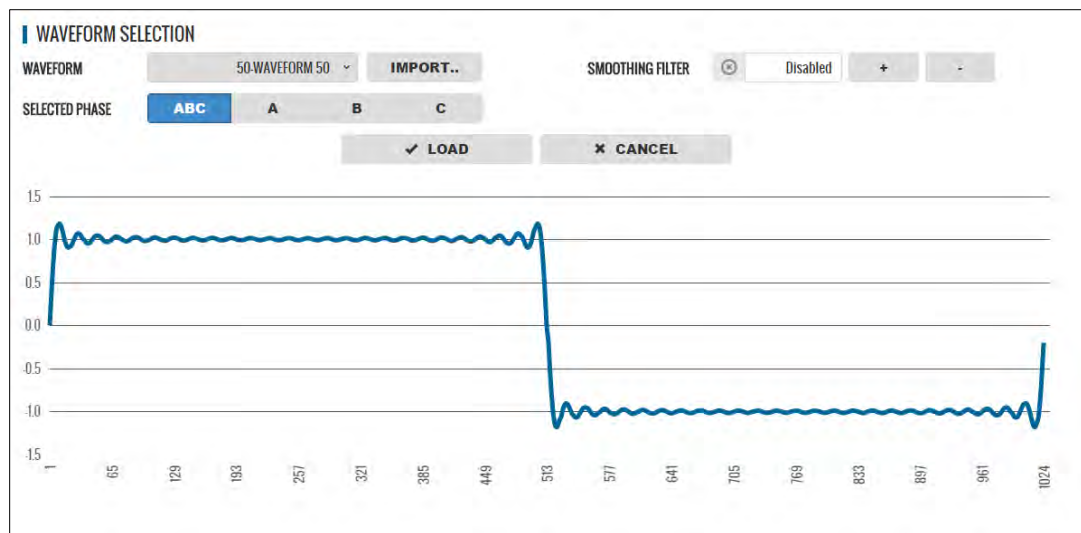


Figure 6-5: Waveform with no Smoothing Filter Applied



Figure 6-6: Same Waveform with maximum smoothing Filter Applied

#### 6.4.10 AUTO RMS Function – Steady State

The AUTO RMS mode, if enabled, causes the AC voltage output value to be calculated as a true RMS voltage of the waveform selected. This means the output RMS voltage will remain at the programmed level regardless of a change in waveform shape. This may or may not be what the user intends. For example, adding a transient spike on a sine wave as part of a user defined waveform will cause the overall RMS value to increase so the sinewave portion of this user defined waveform will be attenuated somewhat when used.

When AUTO RMS is disabled, RMS calculation of substituted waveforms does not occur so the output RMS voltage may change from the set value if the waveform selected for output is not a sine wave. This mode is preferred if switching to a user waveform that has a different mathematical RMS value from a sine wave should NOT result in the output voltage amplitude being adjusted to maintain the same RMS level as with a sine wave. As in the previous example, adding a spike or a dip in part of the sinewave will not affect the output amplitude of the sinewave portion.

**Note:** The setting of the AUTO RMS mode is important when CSC mode is used as CSC mode uses the measured output RMS voltage to adjust the output to maintain voltage regulation.

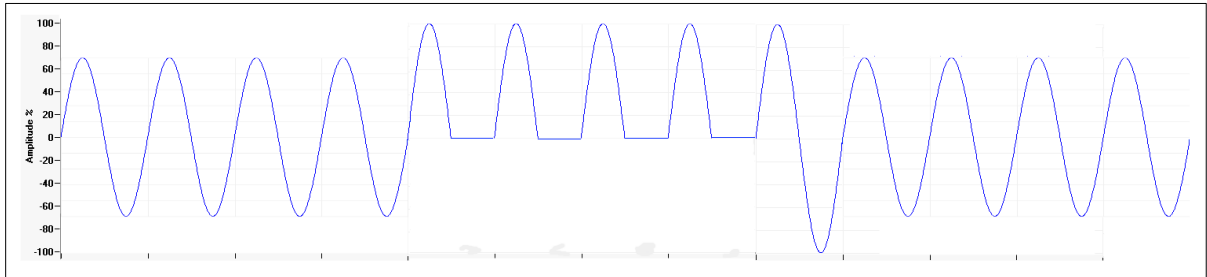
This mode can be set by sending the `[SOURCE:]WAVEFORM:AUTORMS` command over one of the Digital control interfaces.



The following examples illustrate the different behaviors between AUTO RMS mode ON and OFF.

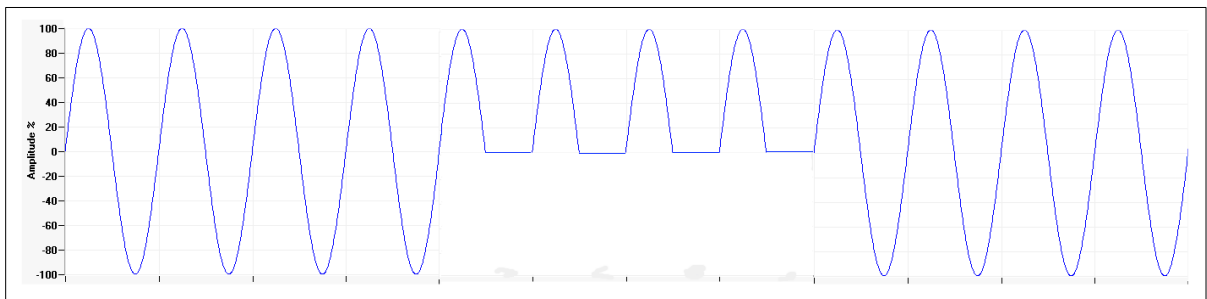
#### 6.4.10.1 AUTO RMS ON Mode:

In the example below a, 100Vrms sine wave is swapped for a half wave rectified ac waveform. The RMS value of this non-sinusoidal waveform is 1.414x that of a sine wave so the peak value is increased to maintain a 100Vrms output voltage with this wave shape. Not that there is a considerable amount of DC offset present as well due to this non-symmetrical waveform.



#### 6.4.10.2 AUTO RMS OFF Mode:

Same waveform example but this time with AUTO RMS mode OFF results in no change to output peak voltage but the actual RMS voltage during these four cycles is only 70.7Vrms instead of the 100Vrms programmed setting.



**Note:** In UPC Compatibility mode, this mode is always enabled.

## 6.5 MEAS – MEASUREMENTS Screens

The MEAS menu key displays the first of two measurement screens. Measurement screens are used to display measurement values taken at the output of the AC power source.

The measurements screen layouts differ between single phase and multiphase mode. If the power source is configured for single-phase mode operation, only the single phase measurement screens are available. When in three phase mode, the user can change screens between all three phases or one phase at a time using the PHASE key located below the Output ON/OFF key or by pressing the “Individual Phase” soft key (SK5).

### 6.5.1 Measurements Screens

The different measurement screen layouts are shown below.

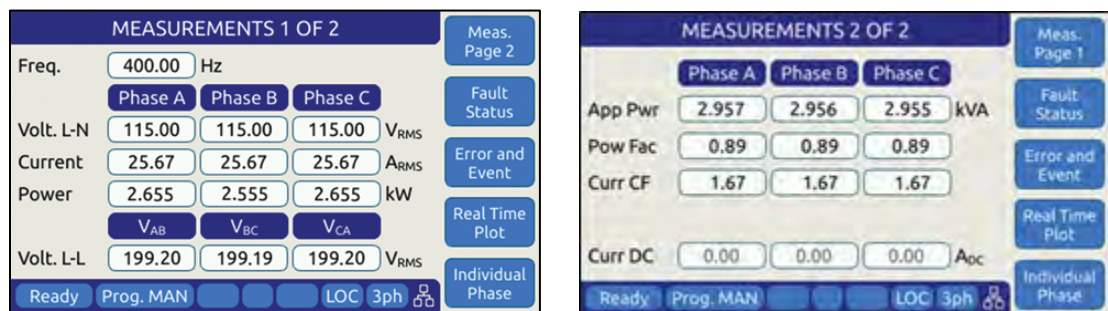


Figure 6-7: Three Phase Measurement Screens

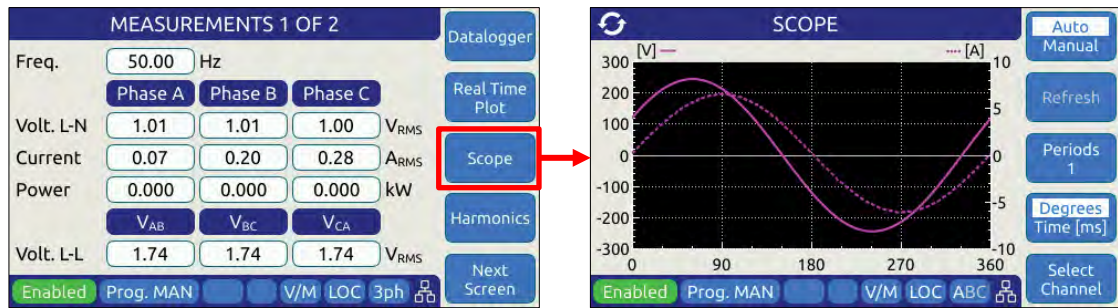


Figure 6-8: Single Phase Measurement Screens for Phase A and B

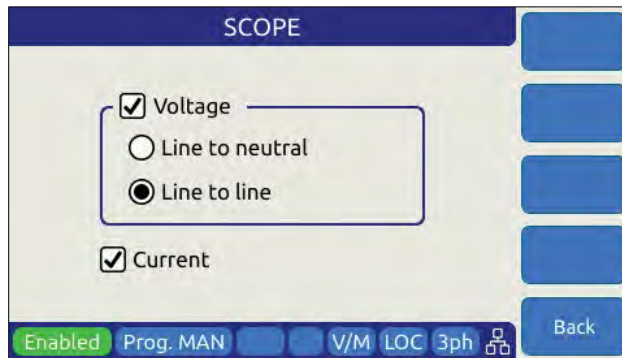
**Note:** The individual phase display screens contain all measurement parameters on one screen so there is one screen for each phase.

### 6.5.2 Scope Measurements

Scope measurements allow all voltage and current phases to be captured and displayed in the time domain. From one to four cycles of the fundamental frequency can be displayed. Display modes include all voltages, all currents, both voltage and current or individual phase selected voltage and current. Use the “Scope” soft key from the Measurement screen to select Scope measurements.



Note that voltage scope captures can be set for Line to Neutral voltage or Line to Line Voltage when in three phase mode. To select the desired mode, use the Select Channel soft key.



### 6.5.3 Harmonic Measurements

Harmonic measurements for all phase voltages and currents can be measured and displayed in either chart or table format. Use the “Harmonics” soft key from the Measurement screen to select Harmonics measurements.

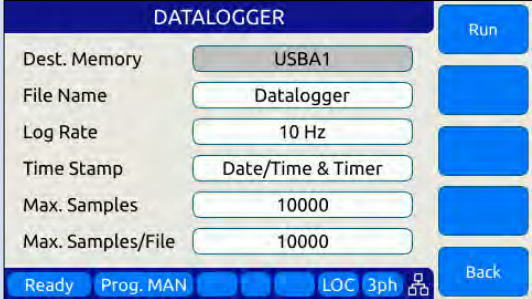
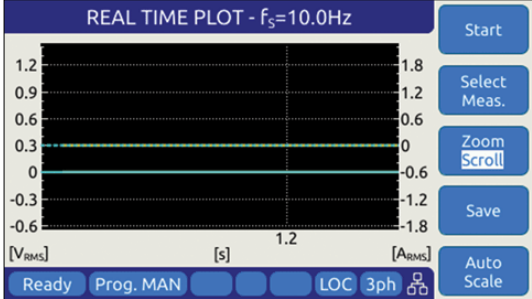
The interface consists of several screens:

- MEASUREMENTS 1 OF 2:** Displays various electrical parameters for three phases (A, B, C). A red box highlights the "Harmonics" button.
- HARMONIC PLOT (%-N):** A bar chart showing harmonic magnitudes for orders 2 through 16. The y-axis ranges from 0 to 1.5.
- HARMONIC PLOT (%-N) (Zoomed):** A larger view of the harmonic plot with a y-axis ranging from 0 to 360.
- HARMONICS ANALYSIS:** A table summarizing the harmonic data.

#	Mag. A [%]	Mag. B [%]	Mag. C [%]
THD	848.20	304.79	856.31
EHD	662.32	219.79	608.35
OHD	529.88	211.16	602.64
1	100.00	100.00	100.00
2	37.14	31.28	24.31
3	95.59	54.31	71.46
4	80.16	9.87	79.46
5	62.99	34.10	82.90

### 6.5.4 Measurement Screen Soft Keys

The following five soft keys are available on the three-phase measurement screen.

SOFT KEY	Description										
<b>Datalogger (SK1)</b>	<p>The Datalogger soft key allows setting the measurement data logging memory type to be selected, sample rate and no. of samples to be logged to memory. To use a usb memory stick (32GB max), insert it in one of the two USB ports on the front panel and select either USBA1 or USBA2. Only memory devices found will be selectable in addition to the default internal RAM (volatile) memory.</p> 										
<b>Real Time Plot (SK2)</b>	<p>Display strip chart of voltage, current or both against time. This provides a trend plot of any available measured parameter.</p>  <p>The following soft keys are available to control the time plot:</p> <table data-bbox="621 1413 1417 1602"> <tr> <td>Start</td> <td>Starts time plot.</td> </tr> <tr> <td>Select Meas.</td> <td>Select parameters to display</td> </tr> <tr> <td>Zoom or Scroll</td> <td>Zoom both X and Y axis</td> </tr> <tr> <td>Save</td> <td>Saves plot data to memory device</td> </tr> <tr> <td>Auto Scale</td> <td>Auto-scale the Y axis (Amplitude)</td> </tr> </table>	Start	Starts time plot.	Select Meas.	Select parameters to display	Zoom or Scroll	Zoom both X and Y axis	Save	Saves plot data to memory device	Auto Scale	Auto-scale the Y axis (Amplitude)
Start	Starts time plot.										
Select Meas.	Select parameters to display										
Zoom or Scroll	Zoom both X and Y axis										
Save	Saves plot data to memory device										
Auto Scale	Auto-scale the Y axis (Amplitude)										

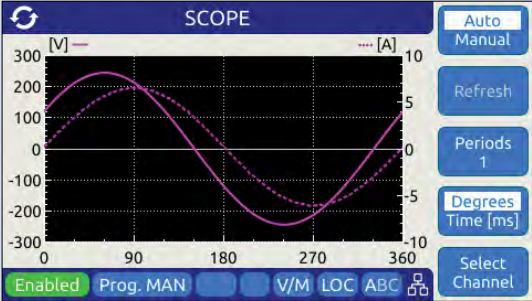
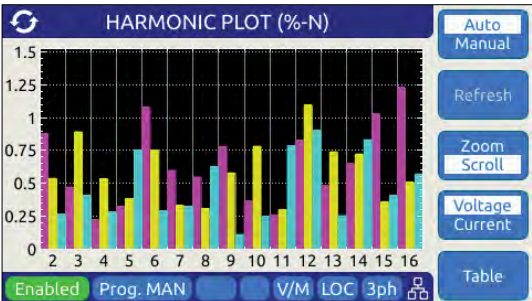
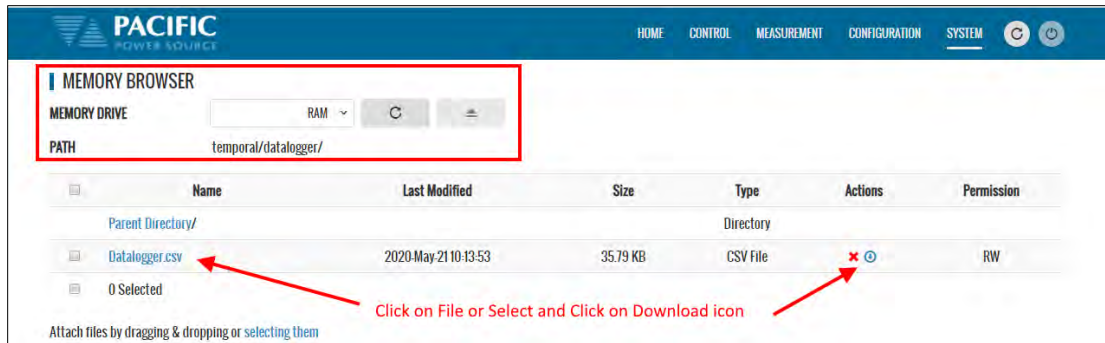
SOFT KEY	Description
<p><b>Scope (SK3)</b></p>	<p>Toggles to the Scope Measurement displac screen.</p> 
<p><b>Harmonicis (SK4)</b></p>	<p>Toggles to the Scope Measurement displac screen.</p> 
<p><b>Next Screen (SK5)</b></p>	<p>This soft key allows toggling between the two available measurement screens. The same can be accomplished by pressing the MEAS button on the left hand side of the LCD display.</p>

Table 6-6: Three Phase Measurement Screen Soft Keys

### 6.5.5 Measurement Data Logging

Logging measurement data is easy to do using the Datalogging function. Files are saved in a comma separated value text file which is easily imported into MS Excel or other programs for analyzer and / or display purposes.

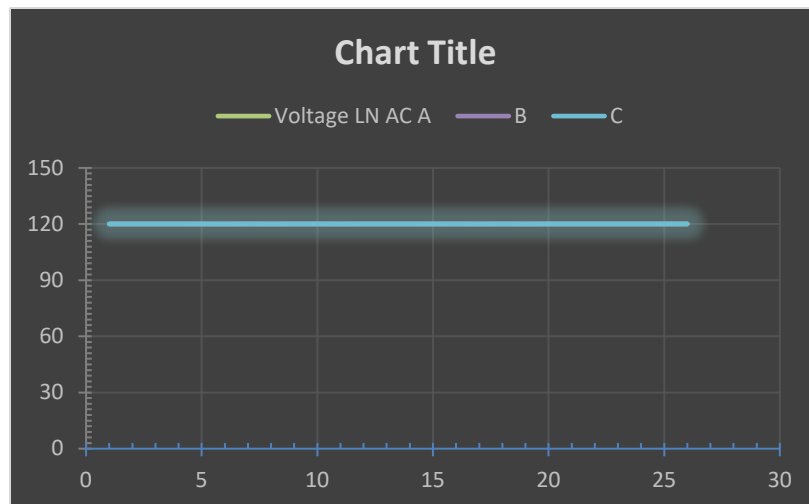
Destination memory defaults to internal RAM allowing log files to be downloaded to browsers or local drives using the web server SYSTEM -> MEMORY BROWSER menu entry.



A small datalogging file sample is shown here for reference.

```
Date & Time,Timer,Frequency,Voltage VLL ACDC A-B,B-C,C-A,Voltage VLL AC A-B,B-C,C-A,Voltage VLL DC A-B,B-C,C-A,Voltage LN ACDC A,B,C,Voltage LN AC A,B,C,Voltage LN DC A,B,C,Current RMS A,B,C,Current DC A,B,C,Power A,B,C,App. Power A,B,C,Power Factor A,B,C,Peak Current A,B,C,Crest Factor A,B,C,
21/4/2020 10:13:17.647,0.00,60,207.846,207.845,207.846,207.846,207.845,207.846,0.0015717,0.000892723,0.000678978,120,120,120,120,5.74293e-05,0.00162913,0.000736408,0.0961562,0.0658469,0.0389105,0.00917411,0.00100751,-0.00516246,0.00012973,0.000672549,0.00066903,0.0115388,0.00790161,0.00466924,0,0,0,0.249016,0.199247,0.126655,0,0,0,
21/4/2020 10:13:17.748,0.101,60,207.845,207.846,207.847,207.845,207.846,207.847,0.000484911,0.000716525,0.000231614,120,119.999,120.001,120,119.999,120.001,0.000291418,-0.000193493,0.000523032,0.0963041,0.0660525,0.0392375,0.00873799,0.000840356,-0.0050699,0.000142419,0.000692023,0.000528912,0.0115565,0.0079262,0.00470855,0,0,0,0.245361,0.199247,0.126651,0,0,0,
21/4/2020 10:13:17.847,0.200,60,207.845,207.843,207.844,207.845,207.843,207.844,0.00195489,0.000834307,0.0027892,120,119.999,119.998,120,119.999,119.998,0.00201776,6.2867e-05,-0.00077144,0.0957361,0.0658142,0.0392642,0.00805068,0.000924351,-0.00582215,0.000124226,0.000720164,0.000534704,0.0114883,0.00789763,0.00471161,0,0,0,0.249,0.195608,0.128863,0,0,0,
21/4/2020 10:13:17.947,0.300,60,207.844,207.847,207.846,207.844,207.847,207.846,7.05616e-05,0.000486062,0.000556624,119.998,119.999,120.002,119.998,119.999,120.002,0.000496289,0.000425727,-6.03351e-05,0.0967671,0.0652786,0.0393575,0.00906719,0.000913487,-0.0051749,0.000184154,0.00060259,0.00057676,0.0116118,0.00783339,0.00472296,0,0,0,0.252638,0.192,0.126645,0,0,0,
```

Using Excel to select several measurement columns allows for easy plotting of trends. For example VLN for A, B and C (Y-axis) against no of samples (X-axis) as shown below.



## 6.6 TRAN- TRANSIENTS Screens

Transient sequences allow precise time-controlled changes to be made to voltage (AC and DC mode) and frequency (AC mode only) under program control. A transient sequence consists of one or more list entries (or segments) that are executed in sequence.

There are three types of Transients modes:

- **LIST Mode**
- **STEP and RAMP Mode**
- **PULSE Mode**

Note that Step and Pulse transients can be accomplished using LIST mode as well but STEP and PULSE data entry is more intuitive.



Transient lists are created or edited in EDIT mode and can be saved to non-volatile memory as part of an instrument setup. They are executed in Execution mode.

The following sections cover all available transient modes.

### 6.6.1 LIST Mode

List mode is the most versatile transient data entry mode as it allows any of the other Transients types to be created as well. However, entering a long ramp or step transient consisting of many discrete steps in List mode is time consuming and tedious. It is also easier to make a mistake in LIST mode than using the STEP or RAMP mode. Same is true for PULSE transients which can be created with a short transient list as well.

LIST transients can be created from the front panel, using the LXI web server and a web browser or with Pacific's PPCS Manager Windows software.

An example Transient LIST created from the front panel is shown below.



#	Freq	Volt AC	Dwell
1	400.00	115.00	100.0
2	400.00	100.00	10.0
3	400.00	115.00	100.0
4	400.00	100.00	10.0
5	400.00	115.00	100.0
6	400.00	100.00	10.0
7	400.00	115.00	100.0
8	400.00	100.00	10.0



### 6.6.2 LIST Parameters

The following parameters are available in each transient list step.

PARAMETER	Range <sup>1</sup>	Unit	Description
#	1 - 199	-	Displays the row number in the transient table. These numbers are generated automatically.
Ramp	0.1 - 10,000,000	msec.	Ramp time to slew from existing set point to new set point value. Applies to both Frequency and Voltage. If previous set value is the same as new value, the value is not slewed but rather stays at the same value for the duration of the ramp time.
Frequency	15 - 1200	Hz	New frequency value
Voltage AC <sup>1</sup>	0 - 135	V rms	New AC voltage value
Dwell	0.1 - 10,000,000	msec.	Dwell time. At the end of the ramp time, the new set values remain in effect during the dwell period. At the end of the dwell time, the next list entry (if any) will be executed.

Table 6-7: Available Transient List Parameters

**Note 1:** Range may differ on models with Transformer (T) option

### Voltage Transient Example

The table and associated figure below illustrates the operation of a transient. The blue line represents the RMS value of the phase A output voltage.

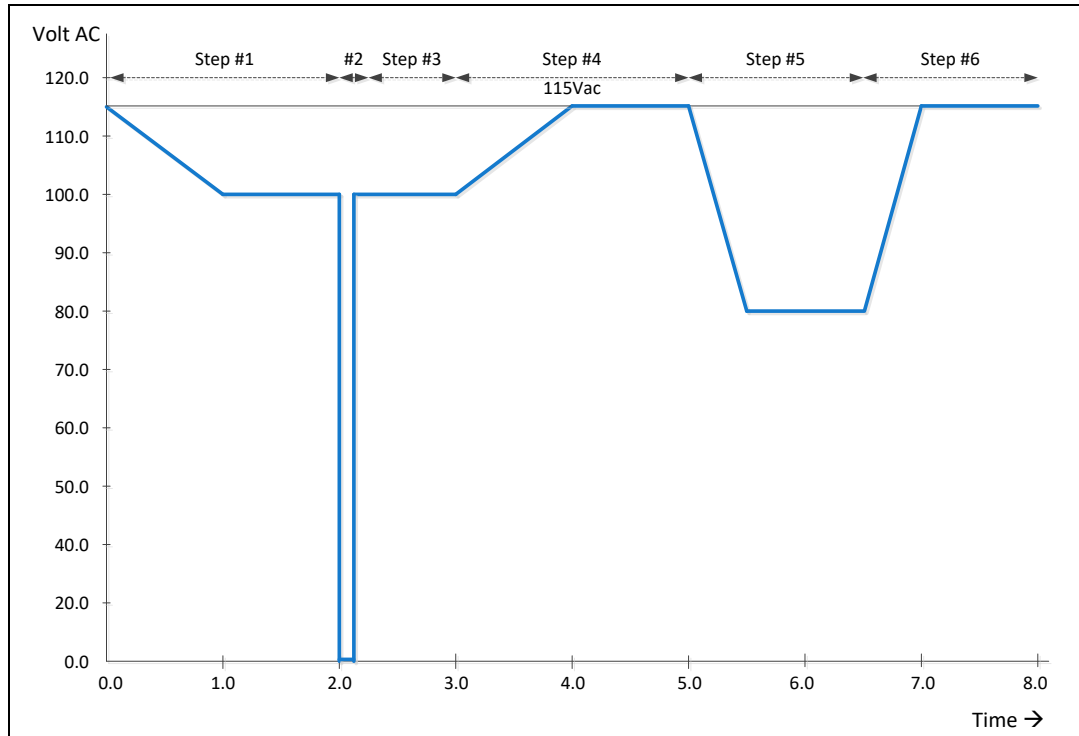


Figure 6-9: Voltage Transient Example 1

To generate this voltage versus time output sequence, the following transient list entries are required. (Ramp and dwell times shown in milliseconds using STEP mode.)

#	Ramp	Freq	Volt	Dwell
1	1000	400	100.00	1000
2	0.2	400	0.00	100
3	0.2	400	100.00	900
4	1000	400	115.00	1000
5	500	400	80.00	1000
6	0.5	400	115.00	1.00

Table 6-8: Voltage Transient List for Example 1

### Voltage and Frequency Transient Example 1

This example is based on an actual avionics test requirement from RTCA/DO160 Section 16 test number 16.5.2.1d. This is a single-phase abnormal voltage and frequency limit test for airborne equipment operated from 400Hz AC power.

The requirement from the test standard is shown in the table below:

TEST	VOLTAGE (V rms)	FREQUENCY (Hz)
1	122	430
2	100	430
3	122	370
4	100	370

Table 6-9: RTCA/DO160 Section 16 test number 16.5.2.1d

There are four tests, each runs for at least 5 minutes or 300 seconds. Each test step has a different voltage and frequency deviation from the nominal 115V and 400Hz. This is graphically illustrated by the image below.

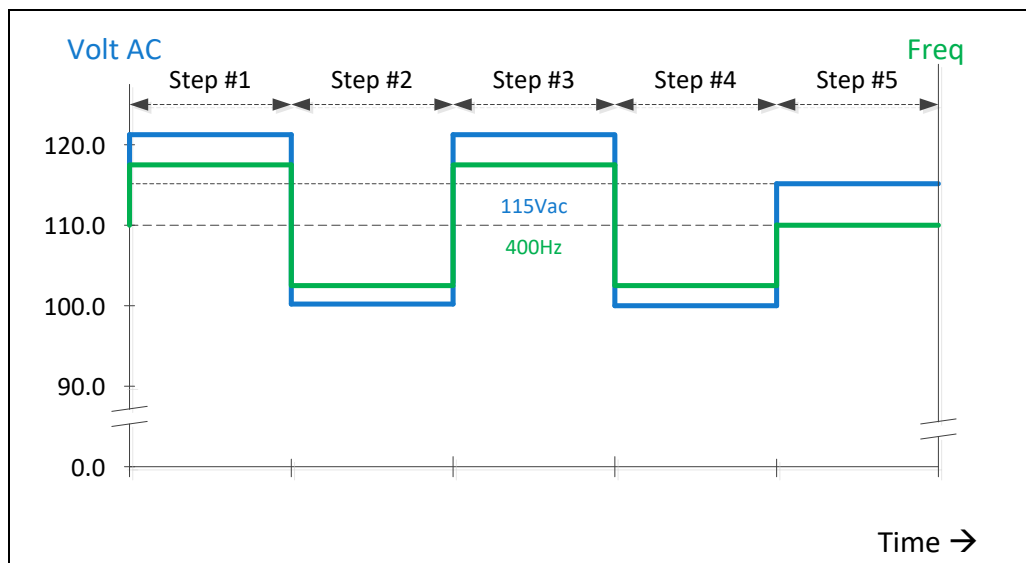


Figure 6-10: RTCA/DO160 Section 16 test number 16.5.2.1d

To generate this DO160 test sequence, the following transient list entries are required. Times shown in milliseconds.

#	Ramp	Freq	Volt	Dwell
1	0.2	430	122.00	300000
2	0.2	370	100.00	300000
3	0.2	430	122.00	300000
4	0.2	370	100.00	300000
5	1000	400	115.00	300000

Table 6-10: Voltage Transient List for Example 1

### 6.6.3 LIST Transient Edit Mode

To create a new transient program, press the **TRAN** key to select the Transient screen. If no transients have been entered or recalled, the initial screen will be blank.

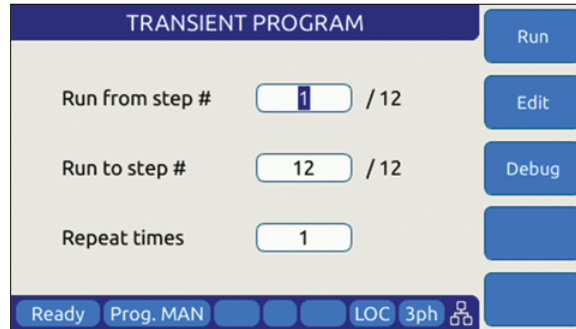


Figure 6-11: Blank TRANSIENT PROGRAM screen

The only available soft key is the “Create” key (SK1). Press the “Create” soft key to enter the Transient Edit mode. This will display the TRANSIENT VIEW screen. Note that “Volt DC” values are always fixed at 0.00 Vdc on LSX models.



Figure 6-12: TRANSIENT VIEW Edit Mode

In Edit mode, a number of soft keys are available to aid in editing new or existing transient lists. They are defined in the following table.

SOFT KEY	Description
<b>Add at the end (SK1)</b>	Adds a new row entry at the bottom of the transient list table. If there are no table entries yet (new), pressing this key will add the first line of a new transient table.
<b>Insert before (SK2)</b>	Insert a new table row before the current selected row. The selected row and any rows below that are all pushed down one position.
<b>Delete (SK3)</b>	Deletes the current selected row. Any rows below the selected row are pushed up one position. <b>Note:</b> This action cannot be undone.
<b>Debug Mode (SK4)</b>	Displays the Debug Execution mode screen. See section 6.6.4

SOFT KEY	Description
Run Screen (SK5)	Returns to the regular TRANSIENT PROGRAM screen used for transient execution mode. See section 6.6.4.

Table 6-11: Available TRANSIENT EDIT screen soft keys

Once created, a transient sequence can be saved as part of the instrument setup. Refer to Section 0 for information on saving and recalling setups.

### 6.6.4 LIST Transient Execution Modes

Transients can be executed as soon as they have been entered. To execute a transient, the output **must be ON**. Sometimes it is best to debug a new transient sequence to make sure it performs the intended test and all values were entered correctly. To do so, the DEBUG mode is provided.

#### DEBUG MODE

The debug mode can be selected from the TRANSIENT VIEW screen by pressing the “Debug Mode” soft key (SK4). This changes the TRANSIENT VIEW screen from EDIT to DEBUG mode and displays a different set of soft keys to control execution.



Figure 6-13: TRANSIENT Debug mode screen

The following execution control soft keys are available.

SOFT KEY	Description
Run (SK1)	Starts the transient from the currently selected row number
Step (SK2)	Single steps one row at a time
Step Mode (SK3)	Executes one step at a time
Edit Mode (SK4)	Stops execution and reverts to Edit mode
Run Screen (SK5)	Returns to the regular TRANSIENT PROGRAM screen used for transient execution mode. See section 6.6.4.

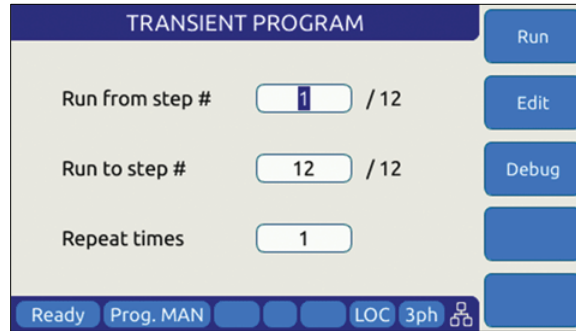
Table 6-12: Available TRANSIENT DEBUG screen soft keys

**Note:** The progress of the transient is indicated by the “Program” status bar at the bottom of the screen.

### NORMAL EXECUTION MODE

Transient execution is controlled from the TRANSIENT PROGRAM screen. If no transient data has been entered, no run mode soft key will be visible. In that case, you must use the “Create” soft key to create a new transient sequence table.

The TRANSIENT PROGRAM screen is shown below.



There are three user settable parameters that control execution of the transient sequence. They are:

1. Run from step #
2. Run to step #
3. Repeat times

Transients will be executed when the “Run” soft key (SK1) is pressed. If the output is **OFF** however, a message will appear indicating the output must be turned **ON** first.

The transient execution will start at the step # set and run until the Run to step value is reached. In the example above, from step #1 through step #6 inclusive.

The “Repeat times” field determines how many times the same sequence will be repeated. To run a sequence indefinitely or until manually stopped, use the shuttle to scroll down to zero or enter zero in this field using the keypad. This will set the repeat field to “indefinitely”.

The following soft keys are available on the TRANSIENT PROGRAM screen.

SOFT KEY	Description
<b>Run (SK1)</b>	Starts the transient from the “Run from step#” row number
<b>Edit (SK2)</b>	Displays the TRANSIENT VIEW edit mode screen. See section 6.6.3
<b>Debug (SK3)</b>	Displays the TRANSIENT VIEW debug mode screen.
<b>Stop (SK4)</b>	Only appears if “Repeat time” value is set to “indefinitely”. Press to stop execution manually

Table 6-13: Available TRANSIENT PROGRAM screen soft keys

### 6.6.5 LIST Transient Entry Modes

The LSX Series® supports two types of transient entry modes:

- LIST STEP Mode
- LIST SEGMENT Mode

Step mode is commonly used on AC and DC power sources that support the SCPI command language as the SCPI standard defines a LIST, STEP and PULSE command syntax.

Segment mode is used on all Pacific Power sources with UPC controllers such as ASX and AMX Series. Both modes support the same capabilities however.

**Note** that in STEP mode, two segment mode entries are combined so each STEP mode entry requires two SEGMENT entries. The two transient examples below represent the same transient display in either mode.

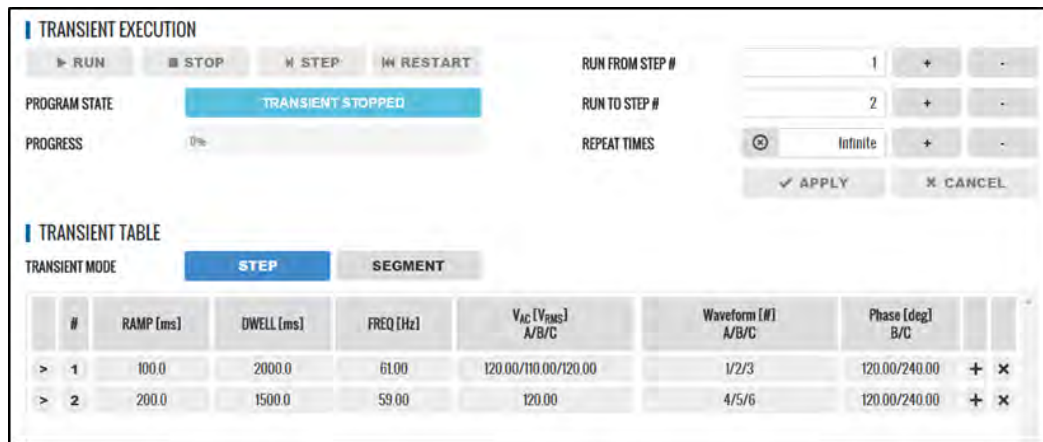


Figure 6-14: Transient shown in STEP Mode

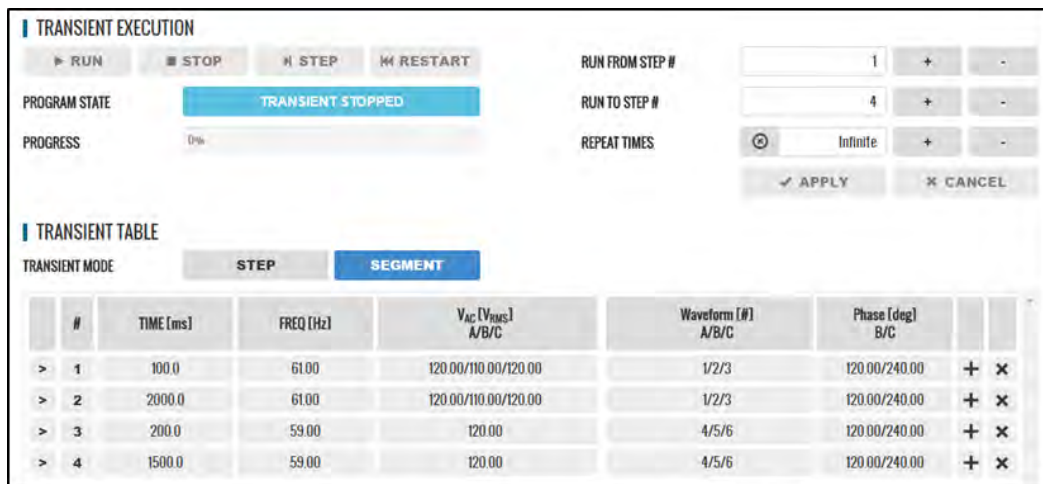


Figure 6-15: Transient shown in SEGMENT Mode

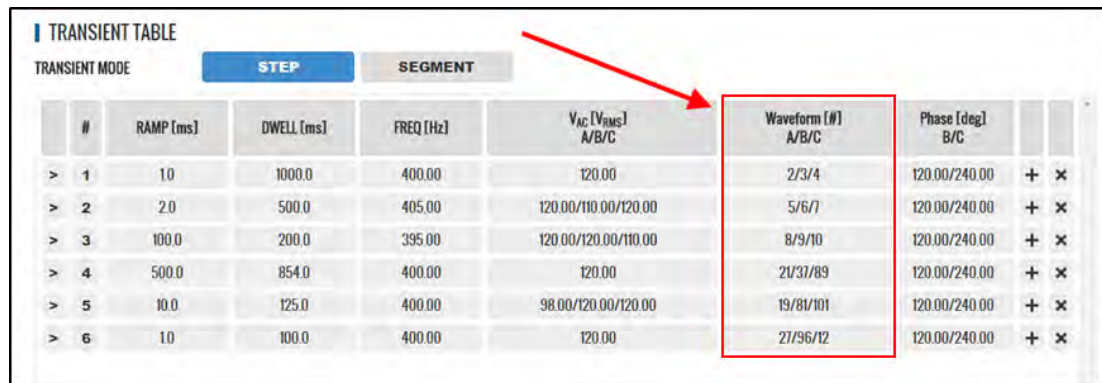
### 6.6.6 Multiple User Waveforms in Transients

Transient programs are very useful to deliver precisely controlled transitions between different waveforms to a unit under test. This means transitions from a normal AC sine wave to a non-sinusoidal or distorted waveform can be accomplished by using different waveform at different segment or step entries.

Waveforms are numbered from 1 through 200 with 1 being a fixed sine wave. All other waveform registers are user defined arbitrary waveforms.

When in AC mode, transient segments or steps can called out different waveform numbers on each of up to three phases. For each segment, up to 128 different waveforms can be selected. The same waveform can be repeated as of often as needed within the same transient program.

In three or split phase mode, each phase in a transient program can use its own set of up to 128 user-defined waveform.



TRANSIENT TABLE							
TRANSIENT MODE		STEP		SEGMENT			
#	RAMP [ms]	DWELL [ms]	FREQ [Hz]	V <sub>AC</sub> [V <sub>RMS</sub> ] A/B/C	Waveform [#] A/B/C	Phase [deg] B/C	
> 1	10	1000.0	400.00	120.00	2/3/4	120.00/240.00	+ x
> 2	20	500.0	405.00	120.00/110.00/120.00	5/6/7	120.00/240.00	+ x
> 3	100.0	200.0	395.00	120.00/120.00/110.00	8/9/10	120.00/240.00	+ x
> 4	500.0	854.0	400.00	120.00	21/31/89	120.00/240.00	+ x
> 5	10.0	125.0	400.00	98.00/120.00/120.00	19/81/101	120.00/240.00	+ x
> 6	10	100.0	400.00	120.00	27/96/12	120.00/240.00	+ x

Figure 6-16: Available User Waveforms in Transients

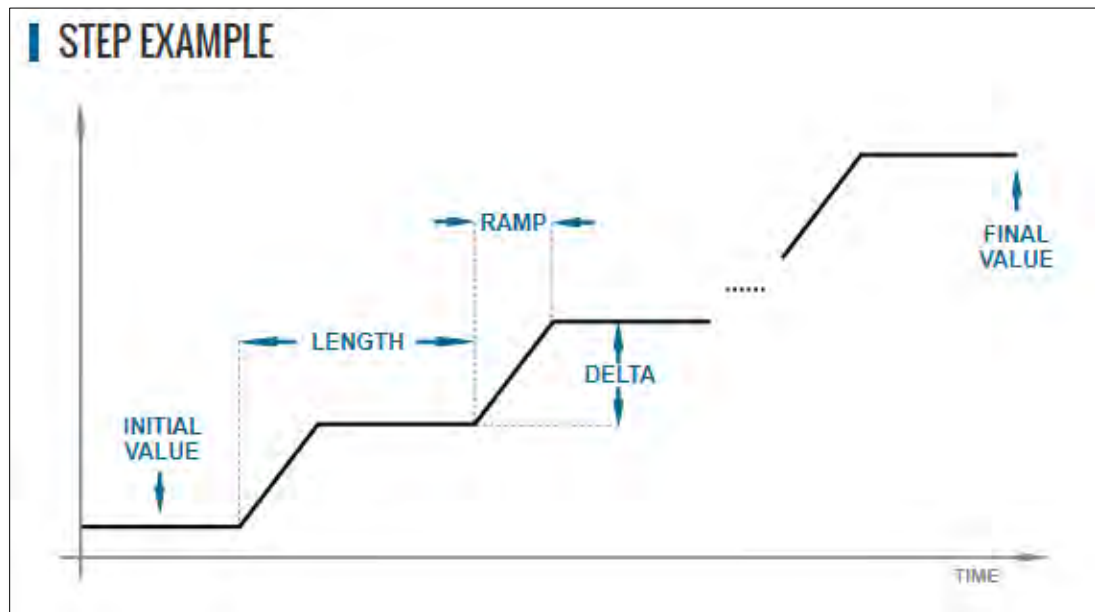


### 6.6.7 STEP or RAMP Modes

STEP and RAMP transients are very similar except in RAMP data entry mode, each step duration is set to the minimum available time interval of 0.1 msec to obtain the smoothest possible ramp result.

In STEP mode, the user sets each increment/decrement and step dwell time.

Step transients are useful for testing over or under voltage protection circuits on AC input supplies. They allow Voltage, Frequency and phase B or C to be steps at discrete intervals and times. An example STEP transient is shown in the screen capture below. It shows the relationship between the RAMP Parameters.



The LENGTH is the dwell time for each step level, including any ramp time. The first step starts from the INITIAL VALUE. The DELTA is the increment or decrement value for each step. The FINAL VALUE determines how many steps will be required to reach it.

Thus, the step COUNT will be:

$$\text{COUNT} = (\text{FINAL VALUE} - \text{INITIAL VALUE}) / \text{DELTA}$$

The total duration to complete the STEP transient depends on the repeat setting, length and if the Insert Initial Value check box is ON or OFF:

If Insert Initial Value = ON (default):

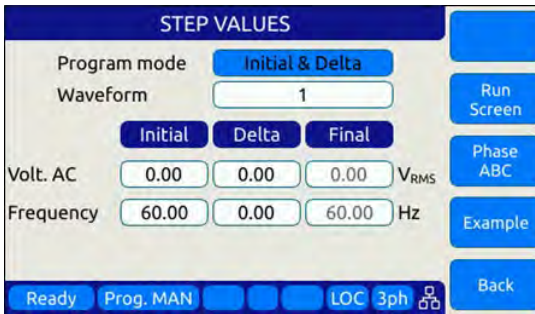
$$\text{DURATION} = \text{REPEAT TIMES} * (\text{COUNT} + 1) * \text{LENGTH}$$

If Insert Initial Value = OFF:

$$\text{DURATION} = \text{REPEAT TIMES} * \text{COUNT} * \text{LENGTH}$$

Step Transients can be programmed from the front panel or the LXI webserver.

### 6.6.8 STEP or RAMP Parameters



Step transients can be used to create discrete stair step like voltage and/or frequency changes or smooth ramps. The default ramp time is 0.1 msec.

Ramps can be programmed in three modes:

- INIDEL (0): Initial & Delta: Programmed by initial and delta values
- FINDEL (1): Final & Delta: Programmed by final and delta values
- INIFIN (2): Initial & Final: Programmed by initial and final values

Step transients can be used to step frequency, AC voltage and phases.

The HOLD is ON, the last step values will be set as steady-state when the step execution ends. Duration of each step is determined by:  $LENGTH = WIDTH + RAMP TIME$

The following parameters are available in a STEP VALUES screen.

PARAMETER	Range	Unit	Description
<b>Program Mode</b>	Initial & Delta Final & Delta Initial & Final	-	Program Entry Modes
<b>Waveform</b>	1 ~ 200		Waveform number
<b>Voltage AC<sup>1</sup></b>	0 ~ 135	Vrms	AC Voltage
<b>Frequency</b>	15 ~ 1200	Hz	Frequency

Table 6-14: Available STEP Transient Parameters

The following soft keys are available on the STEP PROGRAM screen.

SOFT KEY	Description
(SK1)	
<b>Run Screen(SK2)</b>	Displays the STEP EXECUTION screen.
<b>Phase ABC (SK3)</b>	Toggles between phase A, B, C or Coupled ABC
<b>Example (SK4)</b>	Displays a graphical representation of the STEP parameters
<b>Back (SK5)</b>	Returns to previous screen

Table 6-15: Available STEP PROGRAM screen soft keys

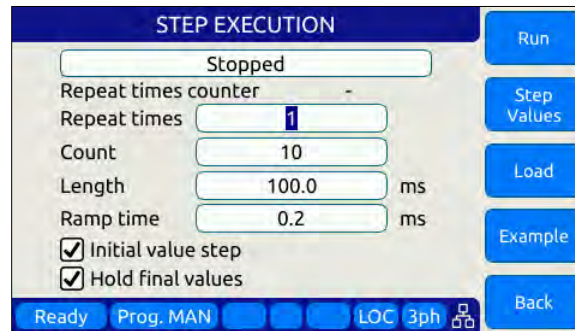
Note 1: Depends on LSX model and T Option if any

### 6.6.9 STEP or RAMP Transient Execution Modes

STEP Transients can be executed as soon as they have been entered. To execute a transient, the output **must be ON**.

STEP or RAMP Transient execution is controlled from the STEP EXECUTION screen. If no STEP or RAMP transient data has been entered, no run mode soft key will be visible. In that case, you must back up to the STEP VALUES screen.

The STEP EXECUTION screen is shown below.



For STEP transients, Count and Length as well as Ramp time are available to be set. The “Hold final values” checkbox determines if the final state after the ramp completes remains at the final ramp values or returns to the settings before the ramp was executed.

Transients will be executed when the “Run” soft key (SK1) is pressed. If the output is **OFF** however, a message will appear indicating the output must be turned **ON** first.

The “Repeat times” field determines how many times the same STEPS or RAMPS will be repeated. To run a sequence indefinitely or until manually stopped, use the shuttle to scroll down to zero or enter zero in this field using the keypad. This will set the repeat field to “indefinitely”.

The “Count” field specifies how many steps will be taken and

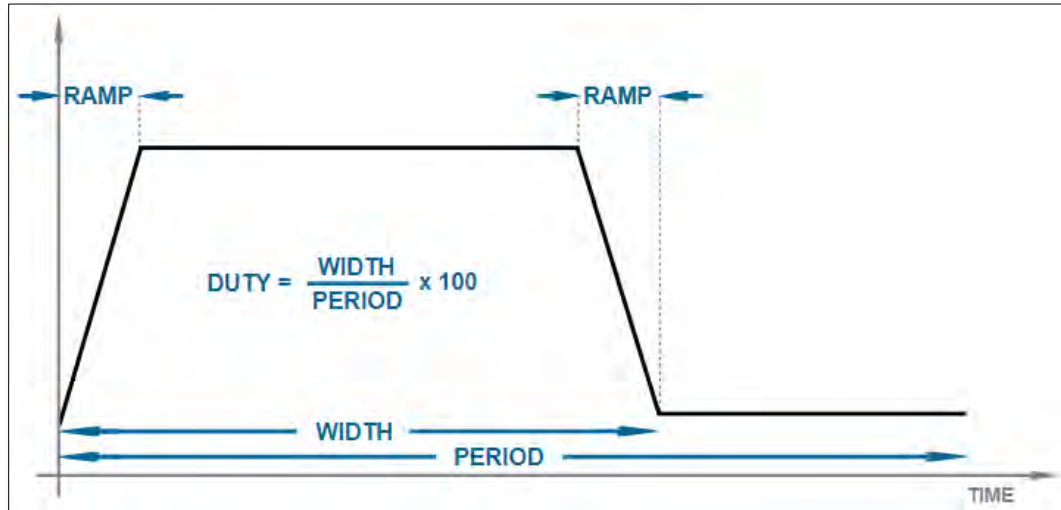
The following soft keys are available on the STEP PROGRAM screen.

SOFT KEY	Description
<b>Run (SK1)</b>	Starts the transient from the “Run from step#” row number
<b>Step Values (SK2)</b>	Displays the STEP VIEW edit mode screen.
<b>Load (SK3)</b>	Converts STEP transient definition to standard transient segments
<b>Example (SK4)</b>	Displays a graphical representation of the STEP parameters
<b>Back (SK5)</b>	Returns to previous screen

Table 6-16: Available STEP EXECUTION screen soft keys

### 6.6.10 PULSE Mode

PULSE transient mode provides a quick and easy way to enter repetitive pulsed output events. This applies to AC voltage and or Frequency. A sample of a PULSE transient definition is shown in the screen capture below.



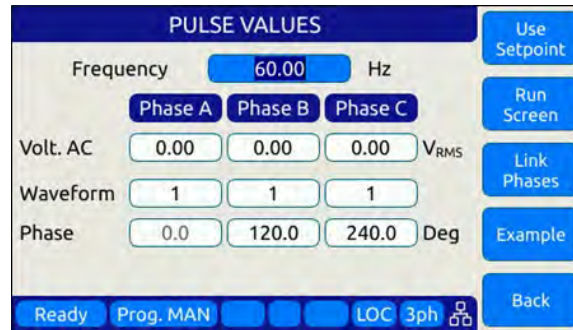
The parameters that define a PULSE transient are dependent of each other so changing one may force another to change. The semantics used for setting PULSE transients is as follows:

Parameter	Description
<b>RAMP</b>	Up or down ramp time
<b>WIDTH</b>	Duration of pulse including rising and failing ramp times
<b>PERIOD</b>	Total time duration for a single pulse
<b>DUTY</b>	Duty cycle of the pulse

The DUTY cycle is determined by the other three parameters as in:

$$DUTY = WIDTH \times 100 / PERIOD$$

### 6.6.11 PULSE Parameters



Pulse transients can be used to create repetitive events for endurance testing of AC and DC powered products.

The following parameters are available in a PULSE VALUES screen.

PARAMETER	Range	Unit	Description
Frequency	15 ~ 1200	Hz	Frequency
Voltage AC	0 ~ 300	Vrms	AC Voltage
Waveform	1 ~ 200		Waveform number
Phase	0.0 ~ 359.9	Deg	Phase angle for phases B & C

Table 6-17: Available STEP Transient Parameters

The following soft keys are available on the PULSE VALUES screen.

SOFT KEY	Description
Use Setpoint (SK1)	Starts the transient from the “Run from step#” row number
Run Screen(SK2)	Displays the PULSE EXECUTION screen.
Link Phases (SK3)	Toggles between phase A, B, C or Coupled ABC
Example (SK4)	Displays a graphical representation of the STEP parameters
Back (SK5)	Returns to previous screen

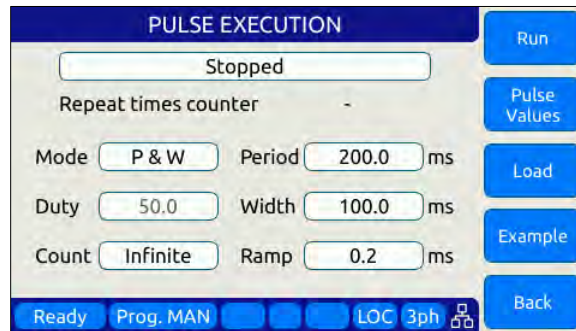
Table 6-18: Available STEP PROGRAM screen soft keys

### 6.6.12 PULSE Transient Execution Modes

PULSE Transients can be executed as soon as they have been entered. To execute a transient, the output **must be ON**.

PULSE transient execution is controlled from the PULSE EXECUTION screen. If no PULSE transient data has been entered, no run mode soft key will be visible. In that case, you must back up to the PULSE VALUES screen.

The PULSE EXECUTION screen is shown below.



For PULSE transients, there are three user settable parameters that control execution of the transient sequence. They are:

- P&W (0): Programmed by Period & Width
- P&D (1): Programmed by Period & Duty Cycle
- W&D (2): Programmed by Width & Duty Cycle

Depending on the data entry mode selected, one of the data entry fields will be disabled and calculated based on the other parameter settings.

Transients will be executed when the “Run” soft key (SK1) is pressed. If the output is **OFF** however, a message will appear indicating the output must be turned **ON** first.

The “Count” field determines how many pulses will be run. To run a sequence indefinitely or until manually stopped, use the shuttle to scroll down to zero or enter zero in this field using the keypad. This will set the repeat field to “Infinite”.

The following soft keys are available on the PULSE PROGRAM screen.

SOFT KEY	Description
Run (SK1)	Starts the transient from the “Run from step#” row number
Pulse Values (SK2)	Displays the PULSE edit mode screen.
Load (SK3)	Converts PULSE transient definition to transient segments
Example (SK4)	Displays a graphical representation of the PULSE parameters
Back (SK5)	Returns to previous screen

Table 6-19: Available STEP PROGRAM screen soft keys

### 6.6.13 AUTO RMS Function – Transients

The AUTO RMS mode, if enabled, causes all transient voltages to be calculated as true RMS voltage of the waveforms used in any Segment of the Transient. This means the output voltage RMS level will remain the same, regardless of the wave shape.

When disabled, RMS calculation of substituted waveforms does not occur. Disabling AUTO RMS facilitates constant amplitude transients such as partial cycle dropouts or sub-cycle spike transients.

This mode is set by sending the **PROGram:TRANSient:AUTORMS** command over one of the Digital control interfaces.

**Note:** In UPC Compatibility mode, this mode is always enabled but applies to steady state only.

## 6.7 CONF – CONFIGURATION Screens

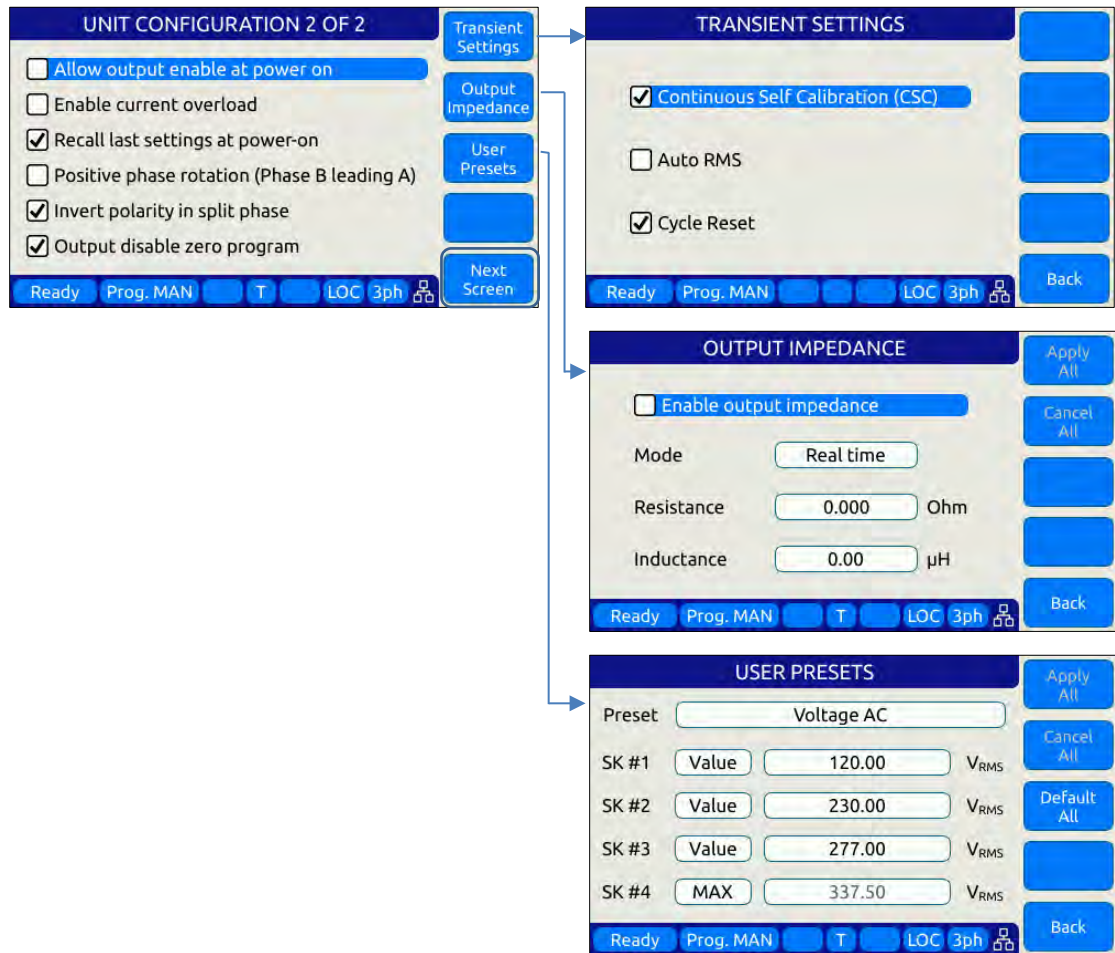
The CONFIGURATION screens 1 & 2 allow setting of secondary parameters functions. These include the following operation aspects:

- Configuration

Pressing the **CONF** key will display the CONFIGURATION screen as shown on the left below.

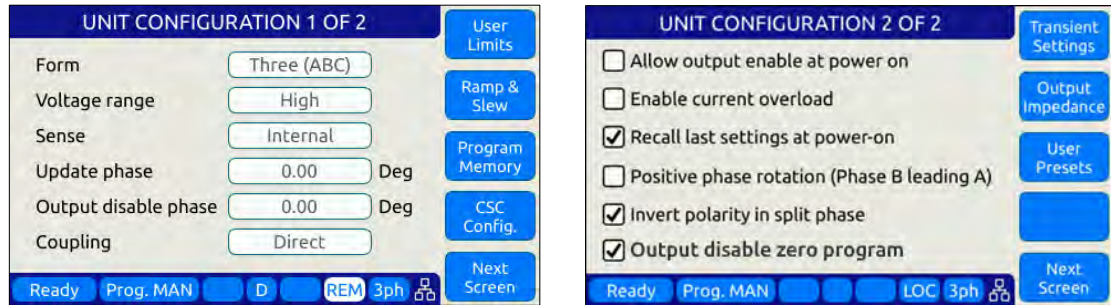
The configuration process starts with the **UNIT CONFIGURATION 1 OF 2** screen, which includes settings for Form (Three (ABC)), Voltage range (High), Sense (Internal), Update phase (0.00 Deg), Output disable phase (0.00 Deg), and Coupling (XFMR (600V)). From this screen, the **User Limits** button leads to the **USER LIMITS** screen, where Voltage AC is set to 0.00 to 337.50 V<sub>RMS</sub> and Frequency is 15.00 to 5000.00 Hz. The **Ramp & Slew** button leads to the **RAMP TIME & SLEW RATE** screen, showing Ramp time as Disabled ms, and Slew rate control as active with settings for Voltage AC (10.00 V<sub>RMS</sub>/ms), Frequency (5.00 Hz/ms), and Phase (5.00 Deg/ms). The **Program Memory** button leads to the **PROGRAM MEMORY** screen, where the Current program register # is MANUAL, and the Recall from register # is set to 1. Finally, the **CSC Config.** button leads to the **CSC CONFIGURATION** screen, which has  Continuous self calibration,  Fault on saturation, and Max CSC gain set to 1.15.





All other system related screens can be accessed using the SYST menu key. (Refer to Section 6.7.6).

### 6.7.1 UNIT CONFIGURATION Screens



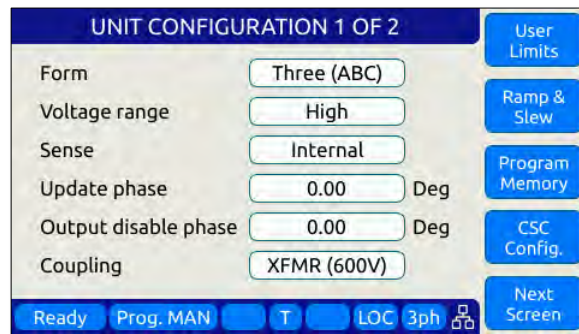
The following settings can be changed from the UNIT CONFIGURATION screens:

#### UNIT CONFIGURATION 1 OF 2-----

- Form** This field displays the phase mode of operation. On 360LSX models this is always “Three (ABC)”. On 160LSX models this is always “Single (A)”
- Voltage Range** Although the power source uses a constant power mode voltage range to allow operation using a single 300Vac voltage range only, the end user can simulate a low voltage range by setting this field to Low. Doing so limits programming of any output voltage to no more than 150Vac or half the available voltage range of the power source. If operation to 300Vac is desired, this field should be set to High. This effectively simulates a conventional dual voltage range model.
- Sense** Selects Voltage Sense mode as either **Internal** (default) or **External**. If External Voltage sense is selected, the sense wires **MUST** be connected to the power source output at the load or a sense fault will occur.
- Update Phase** Sets the phase angle at which output voltage and frequency changes will take place on phase A. This setting applies to both steady state output changes and to the start of a transient program execution. It also applies to the OUTPUT ENABLE and DISABLE function key on the front panel. Changes on phases B and C will take place at the same moment in time but at phase angles that are shifted from phase A by the phase angles programmed for phase B and C.

**Coupling**

This field selects the output coupling mode of the power source. Unless an optional output transformer is installed with the power source (T Option), this field is always fixed to DIRECT. If the optional transformer is installed, the LSX model number will show “LSXT” to indicate the presence of the output transformer. To use the output transformer coupled range, selected XFMR (xxxV) in this field. The voltage indication may vary based on the transformer ration of the installed output transformers.



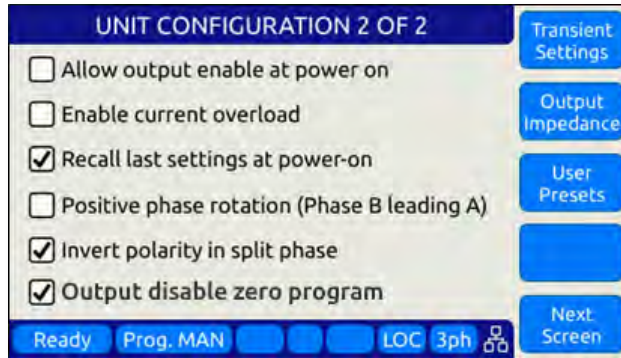
**Note:** In either coupled mode, only AC voltage programming is possible.

Access to other utility screens is available from the UNIT CONFIGURATION screen through the soft keys. The table below lists the available soft keys on the UNIT CONFIGURATION screen.

SOFT KEY	Description
<b>User Limits (SK1)</b>	Displays SETUP MENU screen. Refer to section 0
<b>Ramp &amp; Slew (SK3)</b>	Displays SLEW RATE MENU screen. Refer to section 6.7.3
<b>Program Memory (SK2)</b>	Displays PROGRAM MEMORY screen. Refer to section 0
<b>CSC Config. (SK4)</b>	Display CSC setting screen
<b>Next Screen (SK5)</b>	Toggle to alternate UNIT CONFIGURATION screen

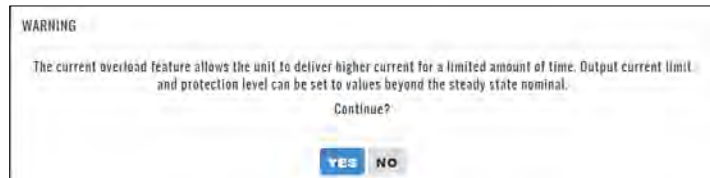
*Table 6-20: Available UNIT CONFIGURATION 1 screen soft keys*

**UNIT CONFIGURATION 2 OF 2** -----



**Allow Output Enable at Power On** This mode if set, causes the output to turn on at power up.

**Enable Current Overload** Current Overload mode allows the power source to provide more than the nominal max. RMS current (around 30 percent more) for a short period (up to 2 seconds). When enabled, the user can set the CURR:LIM 30% higher than when this mode is off. For example in a stand-alone 360LSX unit in three phase mode (FORM 3), RMS output current can be up to 55A when the continuous output limit is 16A. A warning message will be displayed notifying the user this mode is being enabled.



**Recall last settings at power-on** When checked, this mode will cause the last settings that were in effect when the power source was last turned off to be recalled at power on. This allows a user to resume operation without having to set up again between power on/off events.

**Positive phase rotation** When checked, the phase rotation in three phase mode will be set to A -> C -> B corresponding to positive phase rotation for three phase AC motors. To select negative phase rotation, uncheck this option.

**Invert polarity in split phase** When checked, the AC waveform in split-phase mode of operation is shifted 180° (inverted).

**Output disable zero program** When checked, the programmed voltage is first set to zero voltage when pressing the Output Enable button or executing the OUTP OFF command. This allows any energy

stored in the EUT to dissipate into the low impedance output of the power source before the relay disconnects the load.

Access to other utility screens is available from the UNIT CONFIGURATION screen through the soft keys. The table below lists the available soft keys on the UNIT CONFIGURATION screen.

<b>SOFT KEY</b>	<b>Description</b>
<b>Transient Settings (SK1)</b>	Display Transient Configuration Settings
<b>Output Impedance (SK2)</b>	Program Output Impedance R and L values.
<b>User Presets (SK3)</b>	Access to user defined preset value settings for output programming soft keys
<b>Next Screen (SK5)</b>	Toggle to alternate UNIT CONFIGURATION screen

*Table 6-21: Available UNIT CONFIGURATION 2 screen soft keys*

### 6.7.2 USER LIMITS SETTINGS Screen

This screen allows programming user defined voltage and frequency upper and lower limits to prevent an operator from accidentally programming output settings that could be damaging to a unit under test.

For example, when testing a 50 Hz transformer, a lower frequency limit setting of 47 would prevent output frequency programming of values that could cause the transformer to saturate.

This applies to voltage where a high voltage value could damage a unit under test that was not designed to handle high AC input voltage.

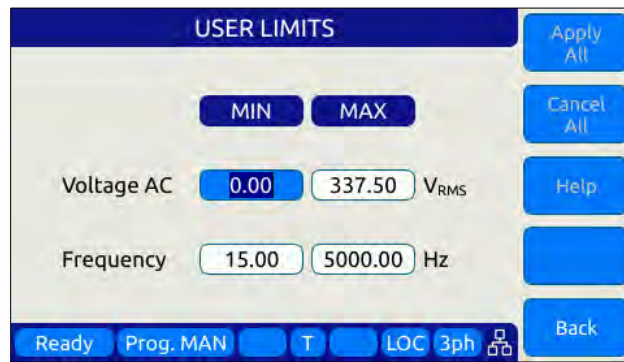


Figure 6-17: USER LIMIT SETTINGS Screen

The following parameters can be set from this screen:

**Voltage AC** Lower and Upper Vrms set limits for AC programming.

**Frequency** Lower and Upper limits for Frequency programming.

The soft keys on the USER LIMITS SETTINGS screen provide access to additional functionality as listed in the table below.

SOFT KEY	Description
<b>Apply (SK1)</b>	Accepts new settings and returns to previous screen.
<b>Cancel (SK2)</b>	Returns to the previous screen.
-	
-	
<b>Back (SK5)</b>	Returns to the previous screen.

Table 6-22: Available USER LIMITS SETTINGS screen soft keys

### 6.7.3 RAMP TIME & SLEW RATE SETTINGS Screen

This screen allows programming of the update ramp time or individual voltage and frequency slew rates, which are applied when changing output settings. Ramp time and slew rate settings are mutually exclusive so Ramp time must be disabled in order to program individual voltage, frequency and phase update rates. Setting a slew rate other than the maximum value allows voltage and frequency changes to occur at a controlled rate of change. The Ramp time when enabled applies to any setting change equally.

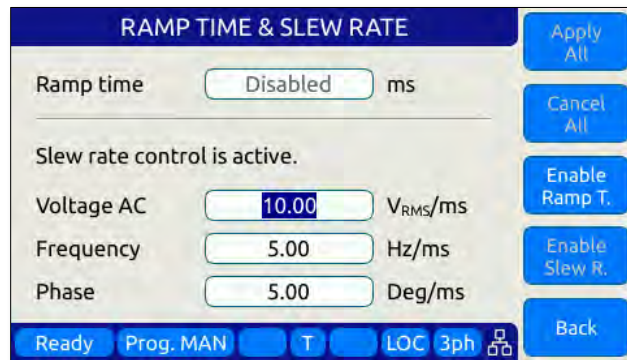


Figure 6-18: RAMP TIME & SLEW RATE SETTINGS Screen

The following parameters can be set from this screen:

- Ramp time** Sets the time over which output changes will take place. For the time set, output changes will ramp from their previous set value to the new set value. When **DISABLED**, changes will occur at the programmed slew rate settings in the SLEW RATE SETTING screen, as both cannot be in effect at the same time. Settings Slew Rate settings provide control over individual parameters whereas the RAMP TIME setting applies to all parameters (F, Vac, Vdc and Phase) changes equally.
  - Voltage AC** AC Voltage slew rate in Vrms per msec. Available range is 0.01 Vrms/ms through 300 Vrms/ms.
  - Frequency** Frequency slew rate in Hz per msec. Available range is 0.01 Hz/ms through 5000 Hz/ms.
- NOTE:** Programmed Slew Rate settings will only take effect when the RAMP TIME setting is **DISABLED**.

The soft keys on the SLEW RATE SETTINGS screen provide access to additional functionality as listed in the table below.

<b>SOFT KEY</b>	<b>Description</b>
<b>Apply All (SK1)</b>	Applies all changes made (highlighted in grey) and returns to previous screen.
<b>Cancel All (SK2)</b>	Cancels all changes (highlighted in grey), sets slew rates back to prior settings and returns to previous screen.
<b>Enable Ramp T.</b>	Enables Ramp time, disables Slew rate settings
<b>Enable Slew R.</b>	Enable Slew Rate settings, disables Ramp time
<b>Back (SK5)</b>	Returns to the previous screen.

*Table 6-23: Available RAMP TIME & SLEW RATE SETTINGS screen soft keys*



### 6.7.4 PROGRAM MEMORY Screen

The Program Memory menu allows saving and recalling of instrument setups in non-volatile memory registers. Setups include all steady state parameters, limits, operating modes and transient list if programmed.



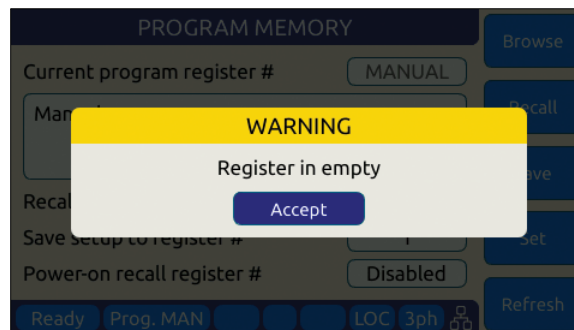
Figure 6-19: PROGRAM MEMORY screen

There are 10 setup registers numbered from 1 through 10. Use the shuttle to select either the Recall or Save field and press the shuttle to enter edit mode. Once the correct number is selected, press ENTER to confirm.

#### Recall from register #

Recalls setup from selected register. If register is empty, an error message will be displayed and no setting will be recalled.

Note: If a register location is empty, an error message will be displayed.



#### Save setup to register #

Saves setup in effect to selected register number. If this register already contained a saved setup, it will be overwritten.

#### Power recall register #

Determines which register number setup is recalled at power-up. Using this feature, the user can determine the power-on default settings of the power source.

The soft keys on the PROGRAM MEMORY screen provide access to additional functionality as listed in the table below.

SOFT KEY	Description
<b>Browse(SK1)</b>	Allows browsing for a particular register’s content.
<b>Recall (SK2)</b>	Recalls selected Register setup content
<b>Save (SK3)</b>	Saves setup to selected Register
<b>Set (SK4)</b>	Sets output to selected Register content
<b>Refresh (SK5)</b>	Return to previous screen

Table 6-24: Available SLEW RATE SETTINGS screen soft keys

### 6.7.5 CSC CONFIGURATION Screen

The CSC CONFIGURATION menu allows the Continuous Self Calibration mode to be enabled. This feature is used to improve load regulation of the power source by continuous measurement of the output phase voltage(s) and adjusting the internal set points as needed to maintain close to zero load regulation. If the CSC is unable to get the output to the set point, an error will be generated. This error can be disabled by unchecking the “Fault on saturation” check box.

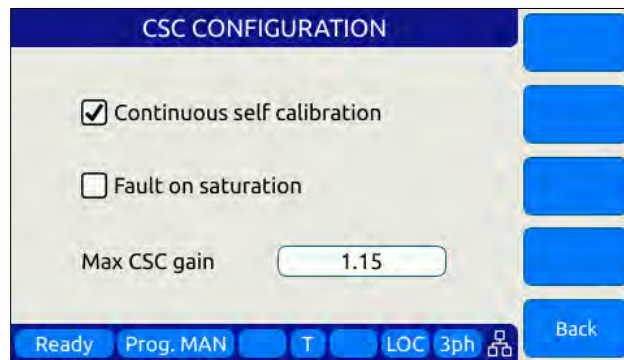


Figure 6-20: CSC CONFIGURATION screen

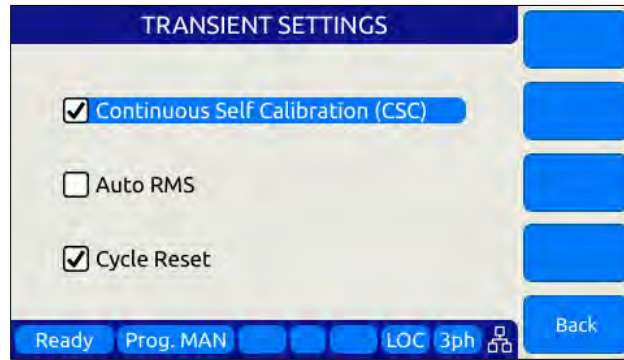
The soft keys on the CSC CONFIGURATION screen are listed in the table below

SOFT KEY	Description
-	
-	
-	
-	
<b>Back (SK5)</b>	Return to previous screen

Table 6-25: Available CSC CONFIGURATION screen soft keys

### 6.7.6 TRANSIENT SETTINGS Screen

The TRANSIENT SETTINGS screen defines operation of transient execution.



Available settings are:

**Continuous Self Calibration** This CSC mode is similar to the CSC mode for steady state operation but applies to transient mode.

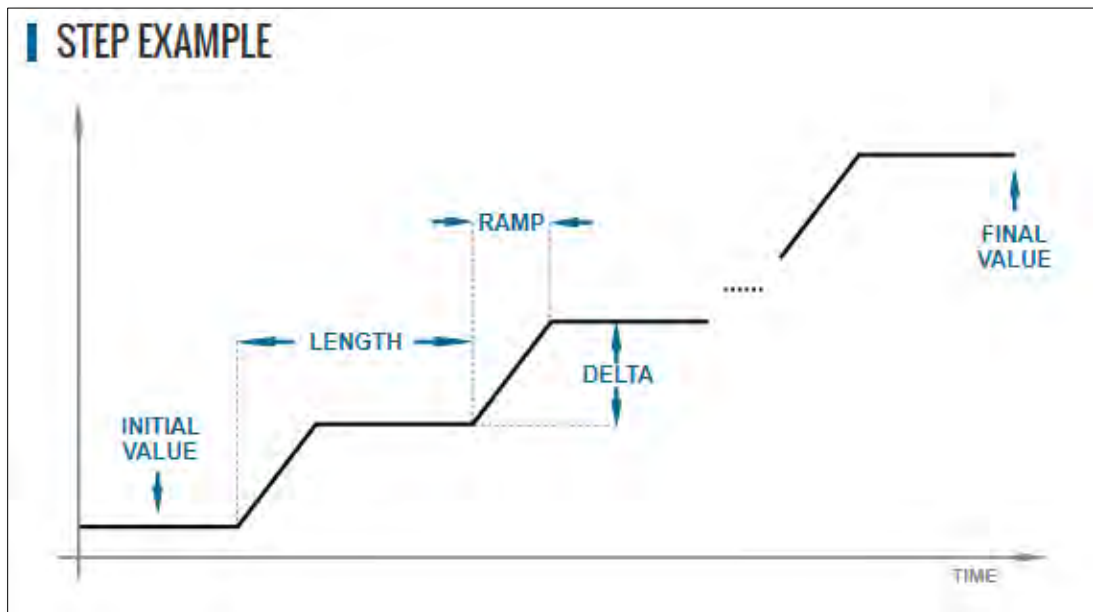
**Auto RMS** This field allows enabling or disabling of the Auto RMS mode for transient mode operation. Refer to section 0, “

### 6.7.7 STEP or RAMP Modes

STEP and RAMP transients are very similar except in RAMP data entry mode, each step duration is set to the minimum available time interval of 0.1 msec to obtain the smoothest possible ramp result.

In STEP mode, the user sets each increment/decrement and step dwell time.

Step transients are useful for testing over or under voltage protection circuits on AC input supplies. They allow Voltage, Frequency and phase B or C to be steps at discrete intervals and times. An example STEP transient is shown in the screen capture below. It shows the relationship between the RAMP Parameters.



The LENGTH is the dwell time for each step level, including any ramp time. The first step starts from the INITIAL VALUE. The DELTA is the increment or decrement value for each step. The FINAL VALUE determines how many steps will be required to reach it.

Thus, the step COUNT will be:

$$\text{COUNT} = (\text{FINAL VALUE} - \text{INITIAL VALUE}) / \text{DELTA}$$

The total duration to complete the STEP transient depends on the repeat setting, length and if the Insert Initial Value check box is ON or OFF:

If Insert Initial Value = ON (default):

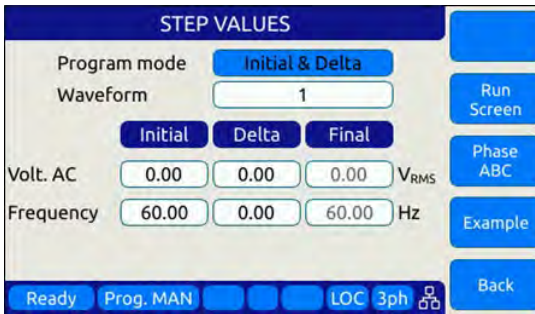
$$\text{DURATION} = \text{REPEAT TIMES} * (\text{COUNT} + 1) * \text{LENGTH}$$

If Insert Initial Value = OFF:

$$\text{DURATION} = \text{REPEAT TIMES} * \text{COUNT} * \text{LENGTH}$$

Step Transients can be programmed from the front panel or the LXI webserver.

### 6.7.8 STEP or RAMP Parameters



Step transients can be used to create discrete stair step like voltage and/or frequency changes or smooth ramps. The default ramp time is 0.1 msec.

Ramps can be programmed in three modes:

- INIDEL (0): Initial & Delta: Programmed by initial and delta values
- FINDEL (1): Final & Delta: Programmed by final and delta values
- INIFIN (2): Initial & Final: Programmed by initial and final values

Step transients can be used to step frequency, AC voltage and phases.

The HOLD is ON, the last step values will be set as steady-state when the step execution ends. Duration of each step is determined by:  $LENGTH = WIDTH + RAMP TIME$

The following parameters are available in a STEP VALUES screen.

PARAMETER	Range	Unit	Description
<b>Program Mode</b>	Initial & Delta Final & Delta Initial & Final	-	Program Entry Modes
<b>Waveform</b>	1 ~ 200		Waveform number
<b>Voltage AC<sup>1</sup></b>	0 ~ 135	Vrms	AC Voltage
<b>Frequency</b>	15 ~ 1200	Hz	Frequency

Table 6-14: Available STEP Transient Parameters

The following soft keys are available on the STEP PROGRAM screen.

SOFT KEY	Description
(SK1)	
<b>Run Screen(SK2)</b>	Displays the STEP EXECUTION screen.
<b>Phase ABC (SK3)</b>	Toggles between phase A, B, C or Coupled ABC
<b>Example (SK4)</b>	Displays a graphical representation of the STEP parameters
<b>Back (SK5)</b>	Returns to previous screen

Table 6-15: Available STEP PROGRAM screen soft keys

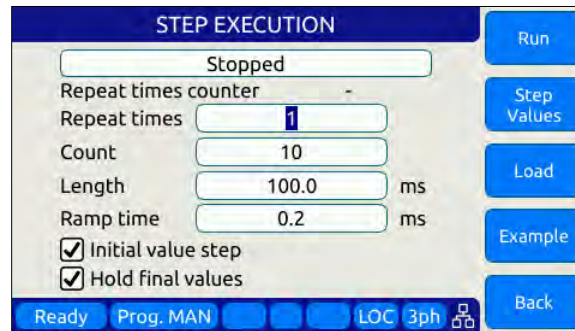
Note 1: Depends on LSX model and T Option if any

### 6.7.9 STEP or RAMP Transient Execution Modes

STEP Transients can be executed as soon as they have been entered. To execute a transient, the output **must be ON**.

STEP or RAMP Transient execution is controlled from the STEP EXECUTION screen. If no STEP or RAMP transient data has been entered, no run mode soft key will be visible. In that case, you must back up to the STEP VALUES screen.

The STEP EXECUTION screen is shown below.



For STEP transients, Count and Length as well as Ramp time are available to be set. The “Hold final values” checkbox determines if the final state after the ramp completes remains at the final ramp values or returns to the settings before the ramp was executed.

Transients will be executed when the “Run” soft key (SK1) is pressed. If the output is **OFF** however, a message will appear indicating the output must be turned **ON** first.

The “Repeat times” field determines how many times the same STEPS or RAMPS will be repeated. To run a sequence indefinitely or until manually stopped, use the shuttle to scroll down to zero or enter zero in this field using the keypad. This will set the repeat field to “indefinitely”.

The “Count” field specifies how many steps will be taken and

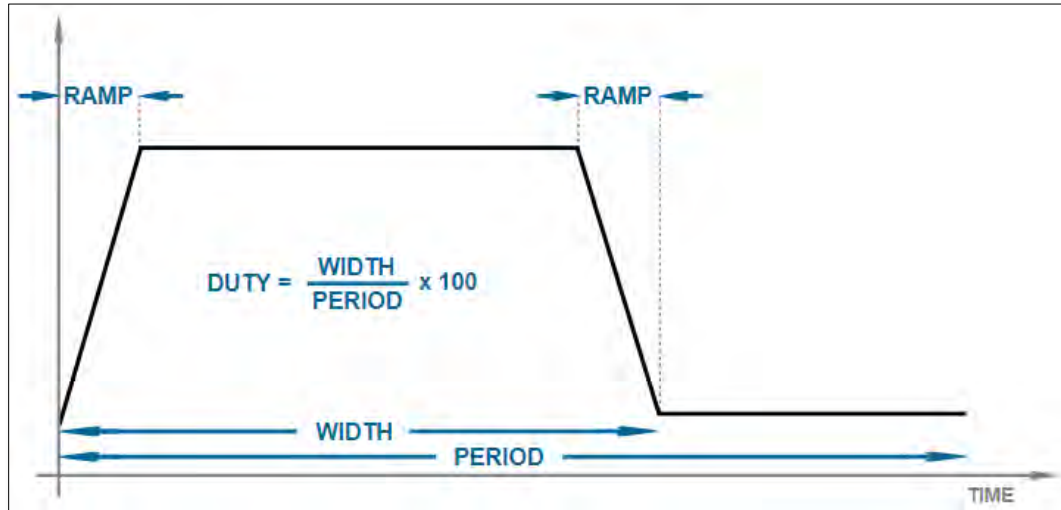
The following soft keys are available on the STEP PROGRAM screen.

SOFT KEY	Description
<b>Run (SK1)</b>	Starts the transient from the “Run from step#” row number
<b>Step Values (SK2)</b>	Displays the STEP VIEW edit mode screen.
<b>Load (SK3)</b>	Converts STEP transient definition to standard transient segments
<b>Example (SK4)</b>	Displays a graphical representation of the STEP parameters
<b>Back (SK5)</b>	Returns to previous screen

Table 6-16: Available STEP EXECUTION screen soft keys

### 6.7.10 PULSE Mode

PULSE transient mode provides a quick and easy way to enter repetitive pulsed output events. This applies to AC voltage and or Frequency. A sample of a PULSE transient definition is shown in the screen capture below.



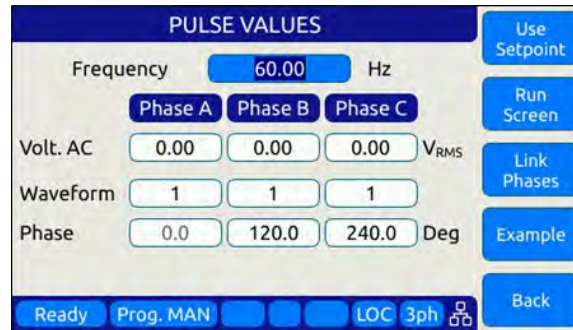
The parameters that define a PULSE transient are dependent of each other so changing one may force another to change. The semantics used for setting PULSE transients is as follows:

Parameter	Description
<b>RAMP</b>	Up or down ramp time
<b>WIDTH</b>	Duration of pulse including rising and failing ramp times
<b>PERIOD</b>	Total time duration for a single pulse
<b>DUTY</b>	Duty cycle of the pulse

The DUTY cycle is determined by the other three parameters as in:

$$DUTY = WIDTH \times 100 / PERIOD$$

### 6.7.11 PULSE Parameters



Pulse transients can be used to create repetitive events for endurance testing of AC and DC powered products.

The following parameters are available in a PULSE VALUES screen.

PARAMETER	Range	Unit	Description
Frequency	15 ~ 1200	Hz	Frequency
Voltage AC	0 ~ 300	Vrms	AC Voltage
Waveform	1 ~ 200		Waveform number
Phase	0.0 ~ 359.9	Deg	Phase angle for phases B & C

Table 6-17: Available STEP Transient Parameters

The following soft keys are available on the PULSE VALUES screen.

SOFT KEY	Description
Use Setpoint (SK1)	Starts the transient from the “Run from step#” row number
Run Screen(SK2)	Displays the PULSE EXECUTION screen.
Link Phases (SK3)	Toggles between phase A, B, C or Coupled ABC
Example (SK4)	Displays a graphical representation of the STEP parameters
Back (SK5)	Returns to previous screen

Table 6-18: Available STEP PROGRAM screen soft keys

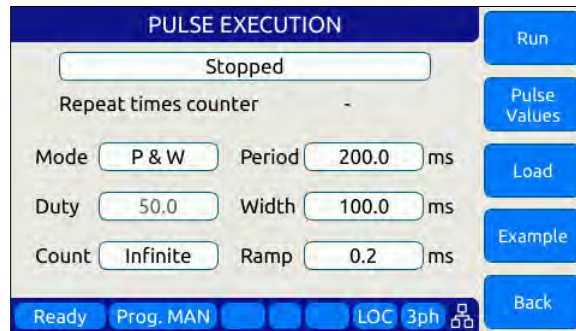


### 6.7.12 PULSE Transient Execution Modes

PULSE Transients can be executed as soon as they have been entered. To execute a transient, the output **must be ON**.

PULSE transient execution is controlled from the PULSE EXECUTION screen. If no PULSE transient data has been entered, no run mode soft key will be visible. In that case, you must back up to the PULSE VALUES screen.

The PULSE EXECUTION screen is shown below.



For PULSE transients, there are three user settable parameters that control execution of the transient sequence. They are:

- P&W (0): Programmed by Period & Width
- P&D (1): Programmed by Period & Duty Cycle
- W&D (2): Programmed by Width & Duty Cycle

Depending on the data entry mode selected, one of the data entry fields will be disabled and calculated based on the other parameter settings.

Transients will be executed when the “Run” soft key (SK1) is pressed. If the output is **OFF** however, a message will appear indicating the output must be turned **ON** first.

The “Count” field determines how many pulses will be run. To run a sequence indefinitely or until manually stopped, use the shuttle to scroll down to zero or enter zero in this field using the keypad. This will set the repeat field to “Infinite”.

The following soft keys are available on the PULSE PROGRAM screen.

SOFT KEY	Description
Run (SK1)	Starts the transient from the “Run from step#” row number
Pulse Values (SK2)	Displays the PULSE edit mode screen.
Load (SK3)	Converts PULSE transient definition to transient segments
Example (SK4)	Displays a graphical representation of the PULSE parameters
Back (SK5)	Returns to previous screen

Table 6-19: Available STEP PROGRAM screen soft keys

AUTO RMS Function – Transients” for further details.

**Cycle Reset**

When enabled, the CYCLE RESET mode will cause repeated executions of the transient as determined by the repeat count or the continuous execution setting to re-sync to the start phase angle set for the start of each transient. When disabled, repeats of the transients start immediately after the previous execution completes with no resync. With Cycle Reset on, there may be up to one period of the AC frequency of delay added between successive runs.

Note: In UPC Compatibility mode, Cycle Reset is default on.

The soft keys on the TRANSIENT SETTINGS screen are listed in the table below

SOFT KEY	Description
-	
-	
-	
-	
<b>Back (SK5)</b>	Return to previous screen

Table 6-26: Available TRANSIENT SETTINGS screen soft keys

### 6.7.13 OUTPUT IMPEDANCE Screen

The OUTPUT IMPEDANCE screen allows the output impedance of the power source to be programmed.



Following parameters can be set from this screen:

**Mode:** Selects between Real time or RMS mode.

- **Real time:** Real-time mode uses a fast responding method to control output impedance. This mode is faster but has a more limited programming range. It works at the signal level implanting a digital filter, equivalent to a resistor and an inductor, in series with the output. It emulates a phase shift and waveform distortion similar to an actual LR impedance at frequencies within the bandwidth of the output amplifier (around 3kHz). CSC must be disabled to use this mode.
- **RMS:** RMS Mode is slower as it relies on the measured RMS output voltages and currents to make adjustments, but it has a wider programming range. It is based on steady state RMS measurements, not on real-time signals, so it does not affect output waveform and phase shift. It allows higher impedance ranges while keeping the output stable. It also allows the CSC mode to remain enabled, so at a steady state level it provides a very accurate voltage drop (on an RMS measurement level).

**Resistance:** Sets the Resistive value for the programmable impedance.

**Impedance:** Sets the Inductive value for the programmable impedance.

The soft keys on the OUTPUT IMPEDANCE screen are listed in the table below

SOFT KEY	Description
-	
-	
-	
-	
<b>Back (SK5)</b>	Return to previous screen

Table 6-27: Available PROGRAMMABLE IMPEDANCE screen soft keys

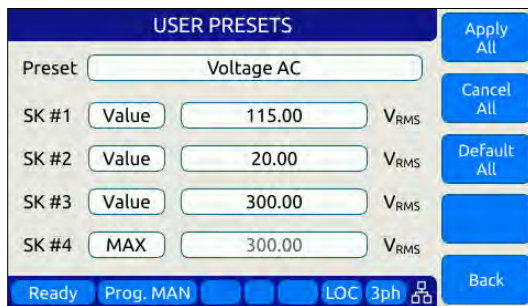
### 6.7.14 USER PRESETS Screen

The USER PRESETS screen allows the soft key set values for output programming that appear in the PROGRAM screen to be changed to setting values preferred by the user.

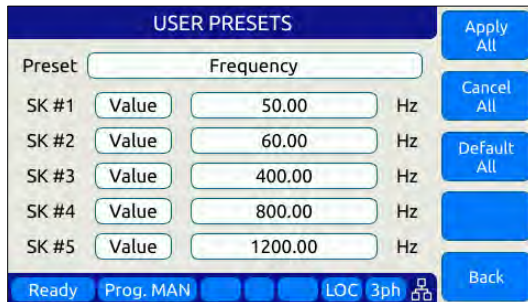
Presets can be defined for the following output settings:

- VOLTage[:AC]
- FREQuency
- CURRent:LIMit
- POWer:LIMit
- KVA:LIMit

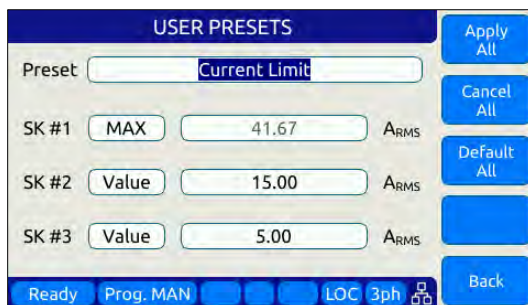
#### 6.7.14.1 AC Voltage Soft keys



#### 6.7.14.2 Frequency Soft keys



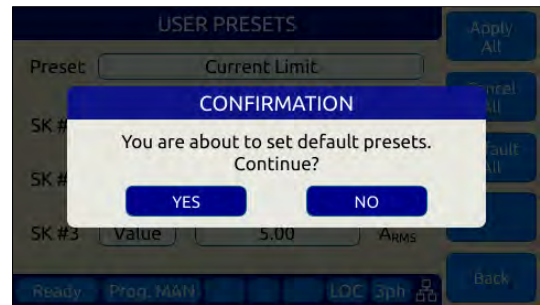
#### 6.7.14.3 Current Limit Soft keys



6.7.14.4 Power and VA Limit Soft keys



For each parameter, the user will be prompted to confirm soft key value setting changes. See dialog to the right. ►



SOFT KEY	Description
<b>Apply All (SK1)</b>	Applies values entered by user.
<b>Cancel All (SK2)</b>	Cancel all changes made.
<b>Default All (SK3)</b>	Sets all soft key settings for selected parameter to factory defaults.
-	
<b>Back (SK5)</b>	Refreshes screen

## 6.8 SYST – SYSTEM Screens

The System screens allow setting of secondary system level functions that are used less often than the first four screens. This generally involves setting system level operation modes and parameters to tailor the instruments operation to the user’s specific requirements and operating environment. These include the following areas:

- Remote Control Interfaces
- System level settings, logs and firmware updates
- Calibration
- Parallel Operation
- Options if any

Pressing the **SYST** key will display the first of two CONFIGURATION screens as shown below.

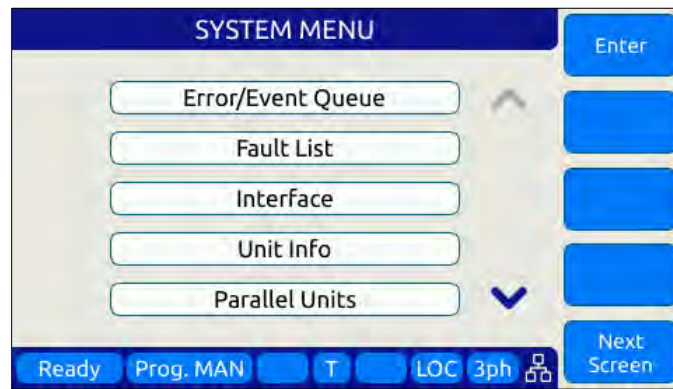


Figure 6-21: SYSTEM MAIN MENU 1

The **More** soft key will allow moving back and forth between the two main SYSTEM screens.

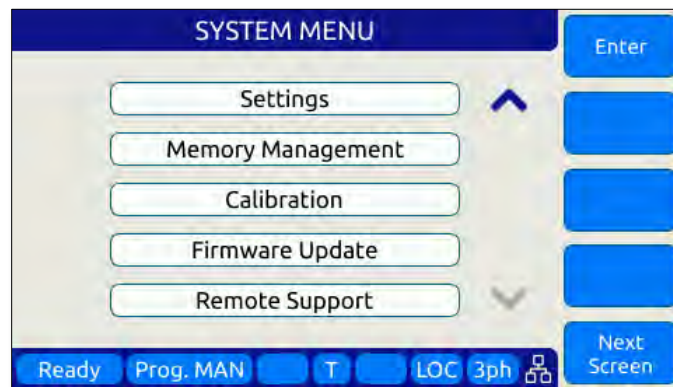


Figure 6-22: SYSTEM MAIN MENU 2

Selections on each screen are made by scrolling through the available entries using the shuttle knob. Pressing the **Enter** soft key, ENTER key or shuttle will display the selected highlighted entry screen.

### 6.8.1 SYSTEM MENU 1

The first SYSTEM MENU allows for selection of the following functions:

- Error/Event Queue Screen
- Fault Information Screen
- Interface Settings Screen
- Unit Information Screen
- Connected Units Screen
- SCPI Console

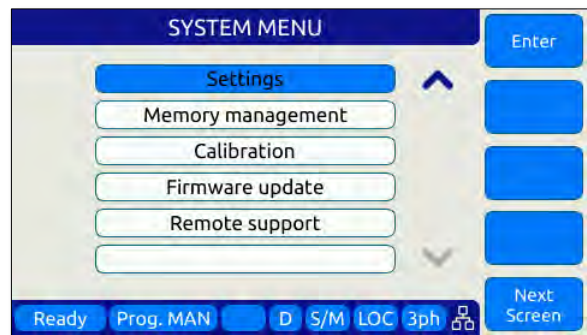


Each screen is covered in subsequent sections.

### 6.8.2 SYSTEM MENU 2

The second SYSTEM MENU allows for selection of the following functions:

- System Settings Screen
- Memory Management Screen
- Calibration Screen
- Firmware Update Screen
- Remote Support Screen



Each screen is covered in subsequent sections.

### 6.8.3 ERROR / EVENT QUEUE Screen

The Error and Event queue shows the history of any errors or events that have occurred since the last time the error queue was cleared.

The error queue can be cleared using a SCPI command over any of the remote control interfaces or by pressing the “Clear Queue” soft key while on this screen.



Figure 6-23: ERROR & EVENT QUEUE Screen

### 6.8.4 FAULT INFORMATION Screen

The fault list shows any logged internal operation faults. This information may be useful when trouble shooting any issues with the power source. In that even, customer service may request this information from the end user or request access to the instrument through the LAN interface for further diagnostics.

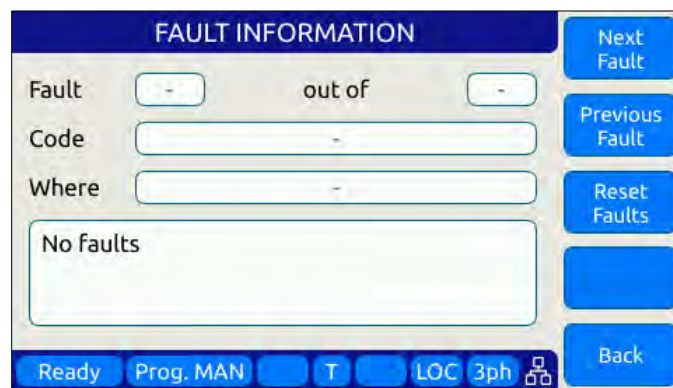


Figure 6-24: FAULT INFORMATION screen



### 6.8.5 INTERFACE Screen

The INTERFACE SETUP screen allows access to the setup parameter of any of the available remote control interfaces.

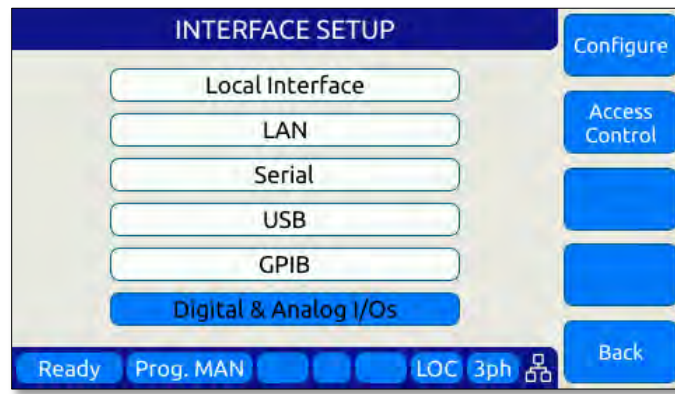


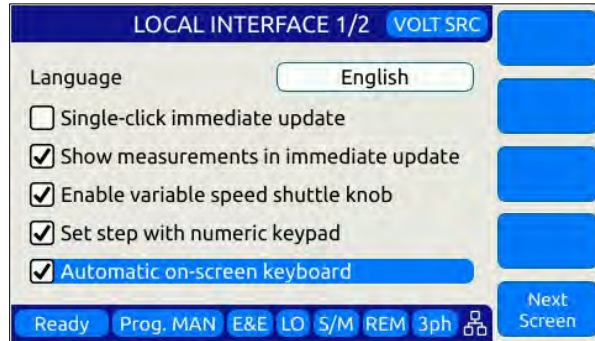
Figure 6-25: INTERFACE SETUP Screen

Available selections are:

- Local Interface (Relates to front panel operation)
- LAN – Ethernet Interface Setup
- Serial – RS232 Serial Interface Setup
- USB – USB Interface Setup
- GPIB – GPIB Interface Setup
- Digital & Analog I/O Setup

Each section is covered in subsequent sections.

6.8.5.1 LOCAL INTERFACE 1 OF 2



Several aspects of front panel operation can be configured by the user from this screen. This relates primarily to the language selection and operation of the shuttle knob, which has three distinct functions:

1. Scrolling values up or down
2. Single Click push function
3. Double Click push function

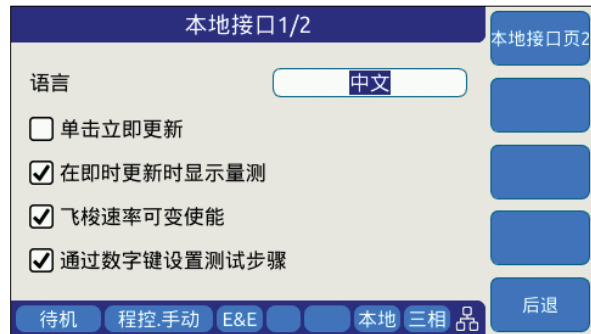
Parameters available to set are as follows:

**Language**

Available language selections are:

- English (default factory setting)
- Chinese.

Language can be switched by pressing the shuttle while on the language field and scrolling between available selections. Press ENTER to confirm selection.



**Single-Click Immediate Mode**

Enters Immediate Mode upon single depression of shuttle knob. Immediate mode means value changes occur immediately on the output of the power source. When unchecked, a double click of the shuttle knob is required to enter this mode.

- Show Measurements in Immediate Mode** When checked, entering immediate mode will result in the Measurement screen being display with the changing parameter showing in the title bar. This allows monitoring of all output measurements while slewing voltage, current of frequency.
- Enable variable speed shuttle knob** When selected, the speed of rotating the shuttle knob will increase the step size of the parameter being changed. If unchecked, changes occur at a fixed step size (resolution).
- Set step with numeric keypad** When set, the numeric keypad can be used to increment or decrement the step size of the shuttle knob. Digits 9 to 1 our use to change from largest step size (9) to smallest step size (1) and any step size in between.
- Automatic on-screen keyboard** This selection enables the on-screen Qwerty keyboard pop-up when the scroll knob is pressed once. When turned OFF, it is still available but requires double clicking the knob. This touch keyboard allows entering of alpha numeric parameters and also supports number value entries. See next section for details.

The following soft keys are available from the LOCAL INTERFACE setup screen:

SOFT KEY	Description
<b>Local Inter. Page 2. (SK1)</b>	Toggle to LOCAL INTERFACE 2 OF 2 screen
-	
-	
-	
<b>Back (SK5)</b>	Returns to previous screen

*Table 6-28: Available USER INTERFACE screen soft keys*

### 6.8.5.2 TOUCHSCREEN KEYBOARD

The on-screen Touchscreen Keyboard features allow entry of alpha numeric values such as names in text entry fields from the front panel. It pops up when the scroll knob is pressed once is set to on or double clicked when set to off in the LOCAL INTERFACE 1 OF 2 Screen.

It is mainly intended for use in text entry fields as the numeric keypad is always available for numeric entries. These are several keyboards available and the default type depends on the data entry field the cursor is on when the shuttle knob is pressed. The number of text characters in each keyboard is limited by the field type.

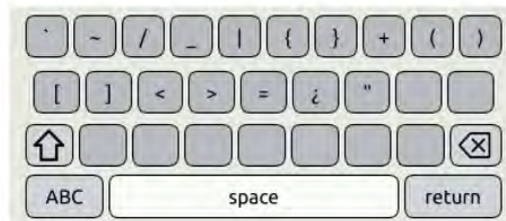
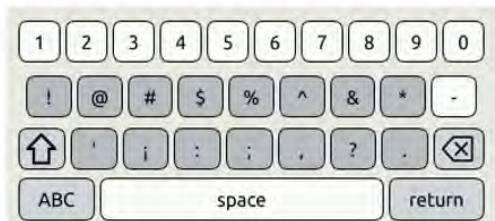
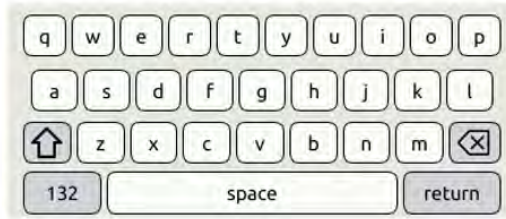
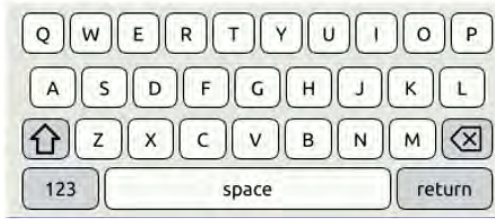
#### Key Descriptions

The following keys are supported:



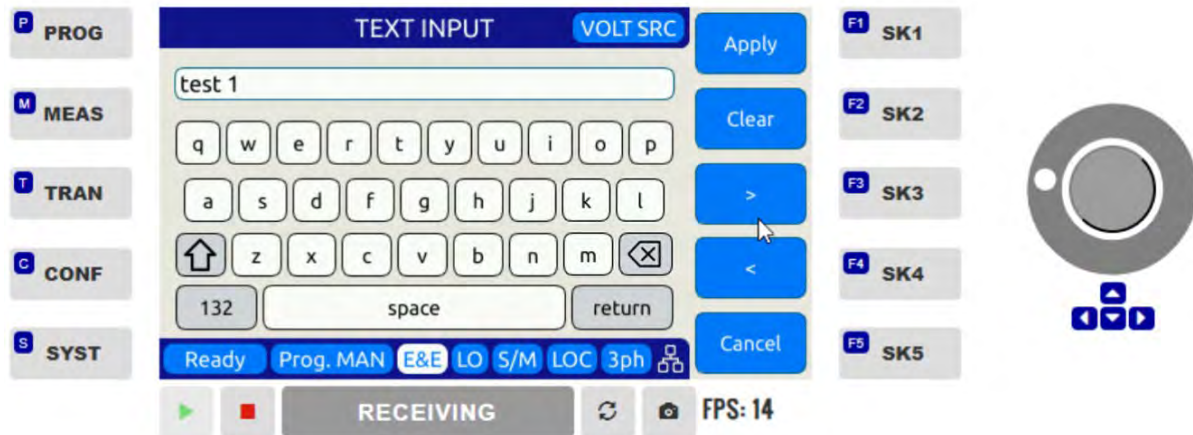
1. Shift: Allows switching between lowercase and uppercase letters, numbers and symbols.
2. 123/ABC: Allows switching from letters to numbers and symbols or vice versa.
3. Return: Places the cursor at the end of the text.
4. Backspace: Deletes the previous character depending on the cursor position
5. Apply: Closes the keyboard and apply text to the field.
6. Clear: Clears all text.
7. Arrows: Allows moving through the text.
8. Cancel: Discards text and close the keyboard

**Available Qwerty keyboard Types:**

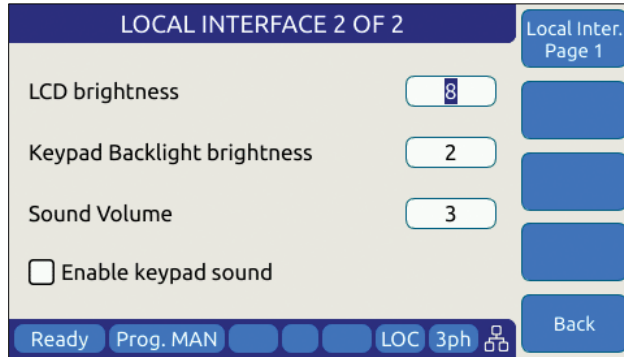


**Web Browser Front Panel Mode.**

The same on-screen keyboard functions are available from the Web browser interface via LAN or USB as shown below.



6.8.5.3 LOCAL INTERFACE 2 OF 2



Several aspects of front panel operation can be configured by the user from this screen. These settings relate primarily to visual and audible user interface aspects:

1. LCD brightness
2. Keyboard Backlight
3. Sound Levels

Parameters available to set are as follows:

<b>LCD brightness</b>	Adjusts the LCD display backlight brightness. Range is 0-9.
<b>Keypad Backlight brightness</b>	Adjusts the keyboard backlight brightness. Range is 0-9.
<b>Sound Volume</b>	Adjusts the loudness of the keyboard and message beeps.
<b>Enable keypad sound</b>	Enables or Disables audible beeps when operating the keyboard.

The following soft keys are available from the LOCAL INTERFACE setup screen:


SOFT KEY	Description
<b>Local Inter. Page 1. (SK1)</b>	Toggle to LOCAL INTERFACE 1 OF 2 screen
-	
-	
-	
<b>Back (SK5)</b>	Returns to previous screen

Table 6-29: Available USER INTERFACE screen soft keys


6.8.5.4 LAN (ETHERNET) INTERFACE SETUP Screen

The LAN INTERFACE SETUP screen allows configuring the Ethernet interface for use with your local area network (LAN) and is accessed from the INTERFACE SETUP screen.

CAUTION



**Do NOT connect the RJ45 LAN (Ethernet) connector of the power source to a PoE (Power over Ethernet) port as the DC voltage will damage the LAN interface.**



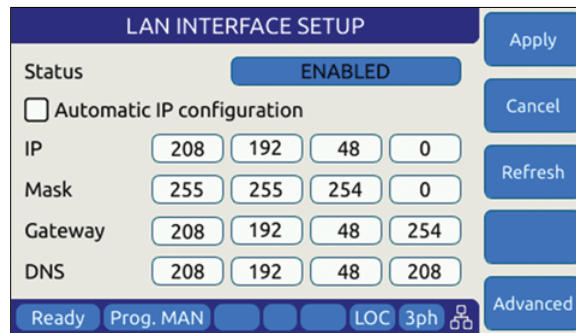


Figure 6-26: ETHERNET INTERFACE SETUP Screen

This screen is used to configure the Ethernet interface for your local area network.

**Note:** You may need to consult your network administrator to set up this interface correctly.

The following parameters can be set on this screen:

- Automatic IP Configuration**     Select this mode if your network has a domain name server running. An IP address will be assigned by the DNS each time the power source is turned on.
- IP**     IP address setting. This address must be unique to your network segment. Consult your network administrator if you are not sure about this setting.
- Mask**     IP mask setting. This mask must be correct for your network. Consult your network administrator if you are not sure about this setting.
- Gateway**     Gateway address setting. Consult your network administrator if you are not sure about this setting.
- DNS**     Domain Name Server address setting. Consult your network administrator if you are not sure about this setting.
- Port**     Port socket address. For message based instruments like this power source, this setting is typically 5025.

The following soft keys are available from the ETHERNET INTERFACE SETUP screen:

SOFT KEY	Description
<b>Apply (SK1)</b>	Accepts new settings and returns to previous screen.
<b>Cancel (SK2)</b>	Returns to the previous screen.
<b>Refresh (SK3)</b>	
-	
<b>Advanced (SK5)</b>	Access detailed LAN Interface Setting screen

Table 6-30: Available ETHERNET INTERFACE SETUP screen soft keys

#### 6.8.5.5 SERIAL INTERFACE SETUP Screen

The SERIAL INTERFACE SETUP screen allows configuring the RS232 serial interface and is accessed from the “INTERFACE SETUP” screen.

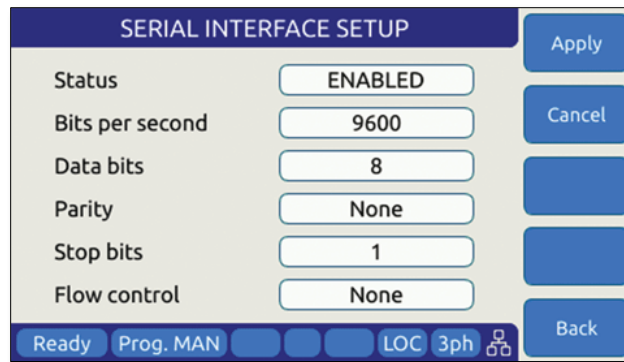


Figure 6-27: SERIAL INTERFCE SETUP Screen

The following parameters can be set on this screen:

- Bits per second** Sets the baud rate. Available settings are 9600, 14400, 19200, 38400, 57600 or 115200.
- Data bits** Sets the number of bits per frame. Available settings are 7 or 8 bits
- Parity** Sets parity check to either odd, even or none.
- Stop bits** Sets the number of stop bits as either 1 or 2.
- Flow control** Sets handshake mode to None or Xon/Xoff

The following soft keys are available from the SERIAL INTERFACE SETUP screen:

SOFT KEY	Description
<b>Apply (SK1)</b>	Accepts new settings and returns to previous screen.
<b>Cancel (SK2)</b>	Returns to the previous screen.
-	



SOFT KEY	Description
-	
<b>Back (SK5)</b>	Returns to the previous screen.

Table 6-31: Available SERIAL INTERFACE SETUP screen soft keys

#### 6.8.5.6 USB INTERFACE SETUP Screen

The USB INTERFACE SETUP screen allows configuring the USB interface and is accessed from the INTERFACE SETUP screen.

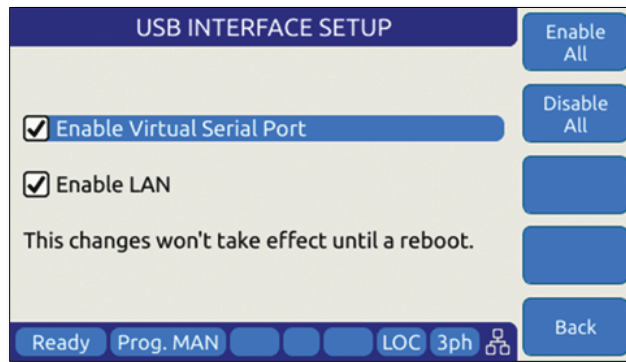


Figure 6-28: USB INTERFACE SETUP Screen

The following settings can be configured on this screen:

- Enable Virtual Serial Port** Enables or disables PC control using a virtual serial port driver.
- Enable LAN** Enables or disables the LAN (Ethernet) Interface IP emulation mode, which supports use of the embedded LXI web server. The virtual IP address of the USB-LAN emulation mode is fixed at 192.168.123.1.

**Note:** Any changes made to this screen will NOT take effect until the power source has been completely powered off and back on. (Re-boot).

The following soft keys are available from the USB INTERFACE SETUP screen:

SOFT KEY	Description
<b>Enable All (SK1)</b>	Set all check boxes
<b>Disable All (SK2)</b>	Clear all check boxes
-	
-	
<b>Back (SK5)</b>	Returns to the previous screen.

Table 6-32: Available USB INTERFACE SETUP screen soft keys

### 6.8.5.7 GPIB INTERFACE SETUP Screen

The GPIB INTERFACE SETUP screen allows configuring the GPIB interface and is accessed from the INTERFACE SETUP screen.

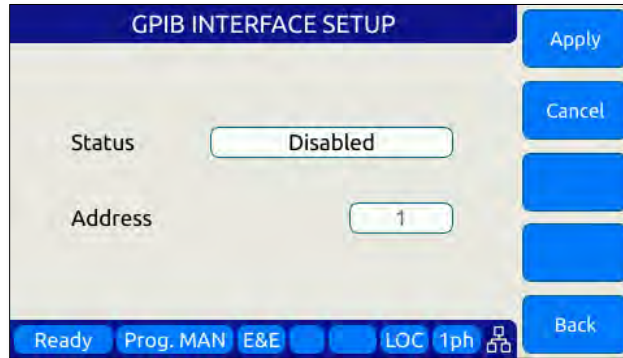


Figure 6-29: USB INTERFACE SETUP Screen

The following settings can be configured on this screen:

- Status** Enables or disables the GPIB interface. Disable when not in use to avoid erroneous interrupts.
- Address** Sets GPIB bus address. Available range is from 1 through 30. Default factory setting is address 1.

The following soft keys are available from the GPIB INTERFACE SETUP screen:

SOFT KEY	Description
<b>Apply (SK1)</b>	Accepts new settings and returns to previous screen.
<b>Cancel (SK2)</b>	Returns to the previous screen.
-	
-	
<b>Back (SK5)</b>	Returns to the previous screen.

Table 6-33: Available GPIB INTERFACE SETUP screen soft keys

### 6.8.5.8 DIGITAL & ANALOG I/Os SETUP Screen

The Digital & Analog IOs SETUP screen allows configuring the auxiliary I/O interfaces and is accessed from the INTERFACE SETUP screen.

For further details, refer to Section 7 on page 184.

### 6.8.5.9 REMOTE INHIBIT SETUP Screen

The REMOTE INHIBIT SETUP screen allows configuring the remote output control input for various modes of operation. Once set, this setting is retained in non-volatile memory so the selection persists between input power cycles.

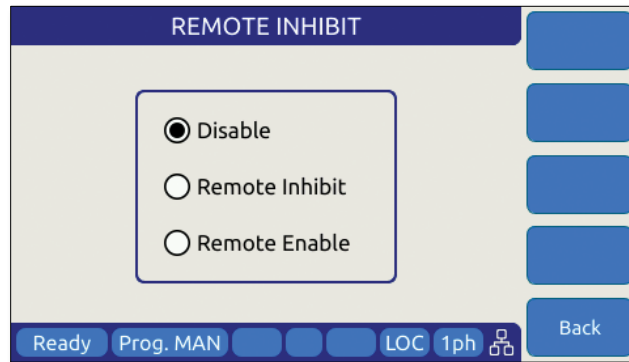


Figure 6-30: REMOTE INHIBIT Setup Screen

There are three modes of operation for this input: remote inhibit and remote enable.

1. **Disable mode:** In his mode, the Remote Inhibit inputs are not active so this function is turned off. No short between the RI pins is required to enable the output in this mode.
2. **Remote Inhibit mode:** The two pins have to be shorted for the output to be enabled from the front panel or remote command. This is a necessary but not a sufficient condition to enable the output. If the output is enabled and the remote inhibit connection is open, a fault is generated. This mode is recommended for interlock safety applications such safety cages and test fixture interlocks.
3. **Remote Enable mode:** The output can be enabled by shorting these two pins, regardless of the output enable command/button. It is a sufficient condition to enable the output.

### 6.8.6 UNIT INFORMATION Screen

The UNIT INFORMATION screen is an information only screen that contains information about the power source and is accessed from the SYSTEM SETTINGS screen using the “Unit info” soft key (SK3).

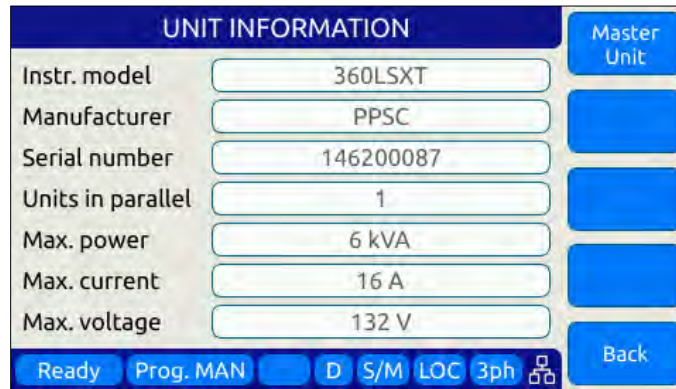


Figure 6-31: UNIT INFORMATION Screen

The following information is provided on this screen:

- Instr. Model** Instrument model number, typically 1xxLSX or 3xxLSX where xx = power rating in VA divided by 100, i.e. 60 = 6000VA.
  - Manufacturer** PPSC stands for Pacific Power Source Corp.
  - Serial number** Unit Serial number.
  - Units in Parallel** Shows number of units in parallel.
  - Max. power** Shows the total output power rating in kVA.
  - Max. current** Shows the maximum current per phase in Arms
  - Max. voltage** Shows the maximum output voltage in Vrms. In split phase mode, shows the L-N Vrms for each phase, not the VLL.
- Note:** This information is for information purposes only and cannot be changed by the operator.

The following soft keys are available from the UNIT INFORMATION screen:

SOFT KEY	Description
<b>Master Unit (SK1)</b>	Shows Master or unit part of a parallel system. Information on the next unit in the chain will be displayed when pressing Next.
<b>Next Unit (SK1)</b>	
<b>Previous Unit (SK2)</b>	If this unit is part of a parallel system, information on the previous unit in the chain will be displayed.
-	
-	
<b>Back (SK5)</b>	Returns to the previous screen.

Table 6-34: Available UNIT INFORMATION screen soft keys

The CONNECTED UNITS screen controls the behavior of this power source in a multi-unit parallel system where two or more power sources are paralleled to provide higher power level systems.

**Note: Paralleling of LSX model units is NOT supported.**

This screen is accessed from the SYSTEM SETTINGS screen using the “Connected Units” entry.

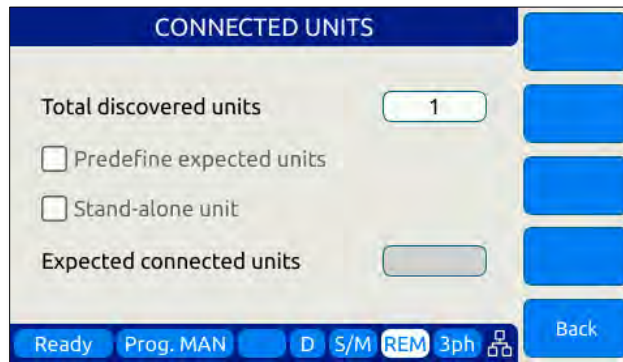


Figure 6-32: PARALLEL UNITS Screen

The first field shows the number of units found at power up on the system bus. A value of 1 means this is a stand-alone unit (not part of a larger system).

The following settings can be configured on this screen:

- Predefine expected units** Tells the power source how many total units to expect to find on the system interface bus at power up. If the number found is less than the number expected as set by the user, one or more units may not be powered up or missing. Leaving this check box off means the system will operate with the number of units found, regardless.
- Stand-alone unit** Set this check box if you want the power supply to operate as a stand-alone unit, even if it is connected to the system interface bus. To do so, you must make sure the outputs of this power source are not connected to any other units' outputs.
- Expected parallel units (n/a)** Use this field to enter the number of expected units only if the “Predefine expected units” option is checked.

The following soft keys are available from the PARALLEL UNITS screen:

SOFT KEY	Description
<b>Discover units (SK1)</b>	Re-scan the system interface bus to determine how many units are on the bus. This also happens at power on.
<b>Back (SK5)</b>	Returns to the previous screen.

Table 6-35: Available PARALLEL UNITS screen soft keys

### 6.8.7 SCPI CONSOLE

The SCIP Console screen allows entry of remote control SPCI command directly from the front panel instead of one of the available remote-control interfaces. This feature is similar to the command line available at the bottom of the Web browser interface Home page.



The following softkeys are available to operate this feature:

<b>Query / Write</b>	Sends the SCPI command shown in the command line on top. The default command is the *IDN? Query which returns the make and mode of the power source. This field will also retain the last command entered by the user.
<b>Clear</b>	Clears the test in the command line and the response area below it.
<b>Scroll Up/Down</b>	Allows scrolling of the text in the response area.
<b>Back</b>	Returns to the System Menu page.

### 6.8.8 SYSTEM SETTINGS Screen

This screen allows system level settings such date and time to be changed. It also access to the UPC Compatibility mode setting.

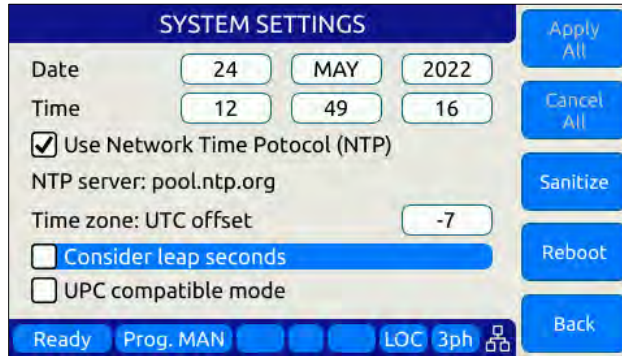


Figure 6-33: SYSTEM SETTINGS Screen

The following parameters can be set from this screen:

<b>Date</b>	Sets the date for the real-time clock.
<b>Time</b>	Sets the time for the real-time clock.
<b>Use Network Time Protocol</b>	When set, the time and date will be adjusted based on the NTP protocol. This requires the unit to be connected to a local area network.
<b>Time zone UTC offset</b>	This parameter sets the number of time zone from UTC where the unit is located to reflect local time. Coordinated Universal Time (UTC) is the primary time standard by which the world regulates clocks and time. It does not observe daylight saving time.
<b>Consider Leap Seconds</b>	When enabled, the time setting incorporated any lead seconds for the current year in the time setting.
<b>UPC compatible mode</b>	When enabled, the controller operates in UPC compatibility mode for backward compatibility with legacy PPS UPC controllers.

The soft keys on the SYSTEM SETTINGS screen provide access to additional functionality as listed in the table below.

SOFT KEY	Description
<b>Apply All (SK1)</b>	Applies all changes made to this screen.
<b>Cancel All (SK2)</b>	Cancels any changes made and returns to previous screen
<b>Sanitize</b>	Erases all user settings from the unit and returns it to its factory default state.
<b>Reboot</b>	Reboot front panel controller without cycling AC input power.

SOFT KEY	Description
Back (SK5)	Returns to the previous screen.

Table 6-36: Available SYSTEM SETTINGS screen soft keys

### 6.8.9 MEMORY MANAGEMENT Screen

The ADF Series® is able to use a wide variety of external storage devices such as USB memory sticks and SD-Cards in addition to its internal storage memory. These devices may be used to store or load data, programs (setup + transient) etc.

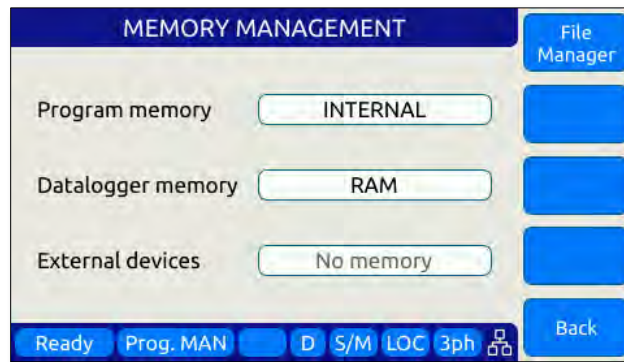


Figure 6-34: MEMORY MANAGMENT Screen

Program storage memory defaults to INTERNAL but can be changed to any available (inserted and mounted) external memory device if needed. The first parameter field is used to make this selection.

If any external memory devices are inserted, they will appear in the “External memories” field at the bottom of this screen.

**Note:** Maximum supported external memory device storage size is 32 GBytes.

The following files types can be located in each of these directories.

Subdirectory	File type and naming convention
<b>plot</b>	Measurement plots
<b>sequences</b>	Test sequences
<b>screenshots</b>	PNG image files captured from the LCD screen with filename convention <b>screenshot_YYYY-MM-DD_HH-MM-SS.png</b> where YYYY-MM-DD_HH-MM-SS is the time stamp.
<b>waveforms</b>	CSV comma separated waveform data files with filename convention <b>X.csv</b> where X is a number form 2 through 200.
<b>program</b>	Steady state + transient segment files using filename convention <b>program_xx.xml</b> where xx = 00 through 99 indicated program memory location #.



### 6.8.9.1 Loading Programs from a USB Drive.

Programs stored on a USB drive using the directory structure shown in the previous section can be loaded using the Browser interface – see section 10.7.4 on page **Error! Bookmark not defined.**– or from the front panel.

To load from the front panel USB ports, store the program\_xx.xml file in the program subdirectory and insert in one of the two USB A ports on the front panel. After a short period of time, the drive will mount and will be visible in the CONF -> PROGRAM BROWSER screen.



Select the USBA1 drive in the upper right corner Memory field to see the available program files on the USB drive. Scroll down with the shuttle to select the desired program file to load.

Then use the **Recall** Softkey to load the selected program file. The program will now be available in the assigned program memory location as determined by the XML file name.



**Note:** program\_xx.xml files must have a Steady State section to be valid. The Transient section may be empty in which case no transient will be loaded.

### 6.8.9.2 File Manger Operation

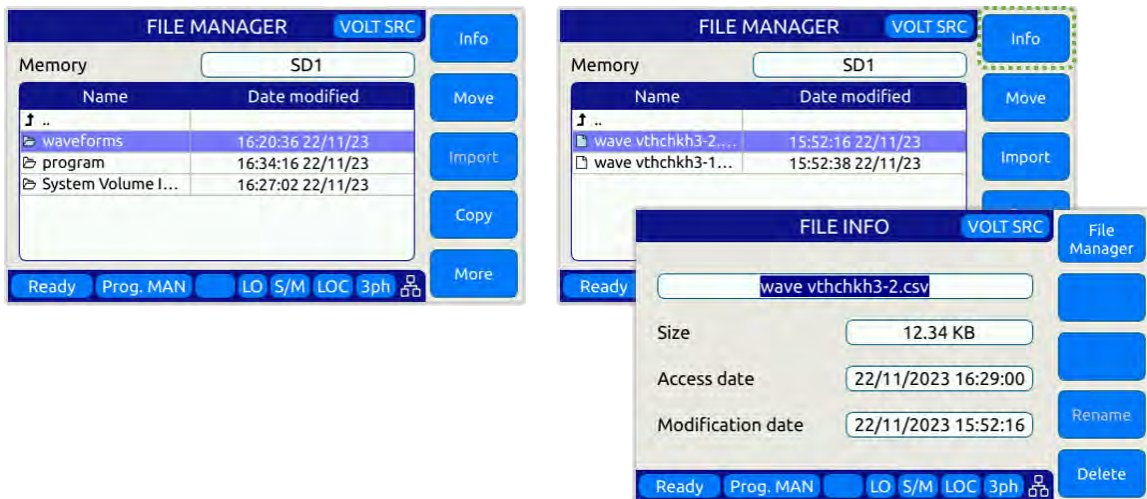
To access the File Manager functions, Press “**SYST**” -> **Memory management**” –(**Sk1**) **File Manager**”. The File Manager allows the user to browse through the directories and files stored on the selected memory type, INTERNAL, RAM or External media. Select the relevant memory type before entering this screen. See sample screens below.



This screen contains file info such as date/time, and supports the following functions:

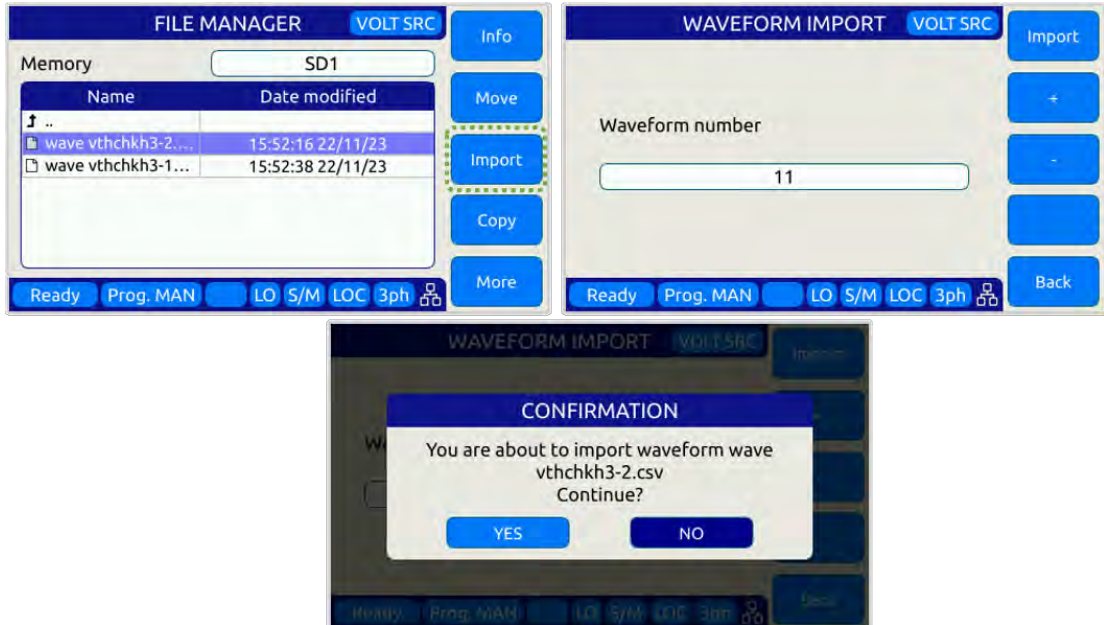
1. Move, Copy and Delete files.
2. Create new folders.
3. Import Waveforms.
4. Import Programs.

To navigate between files and folders, use the shuttle knob to select a folder and press to enter.



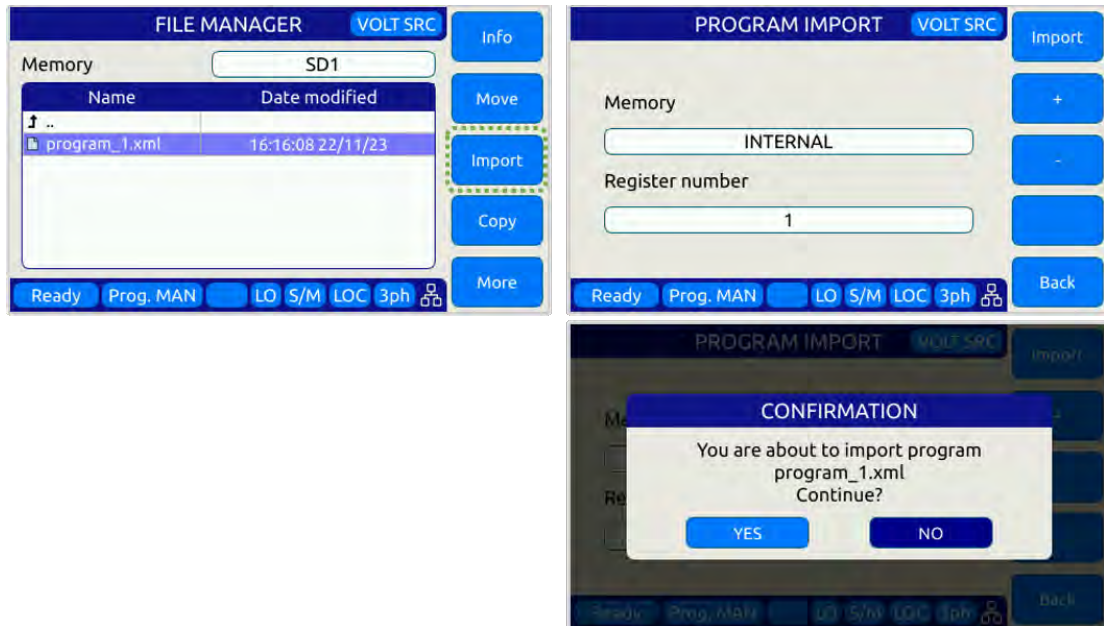
### Importing Waveforms

The Import softkey allows importing of CSV format waveforms. Select the location to import the content of the waveform from. Use the +/- softkeys or the shuttle knob to scroll the waveform number. Press the Import (Sk1) softkey and YES to confirm when prompted.

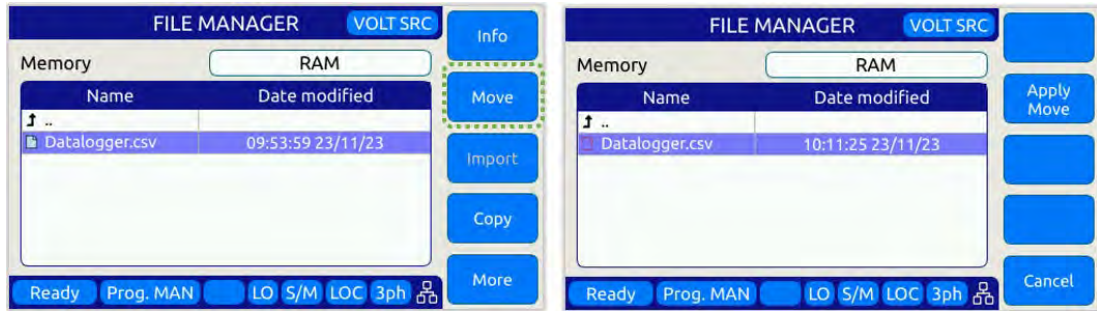


### Importing Programs

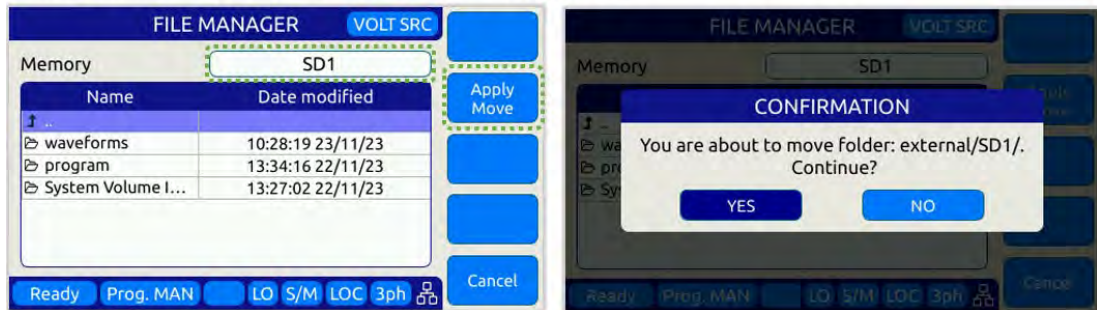
Importing xml format program files uses a similar process except they are stored in a register location by number. Select the desired program file, select the memory type and register number and press Import (Sk1), the confirm when prompted.



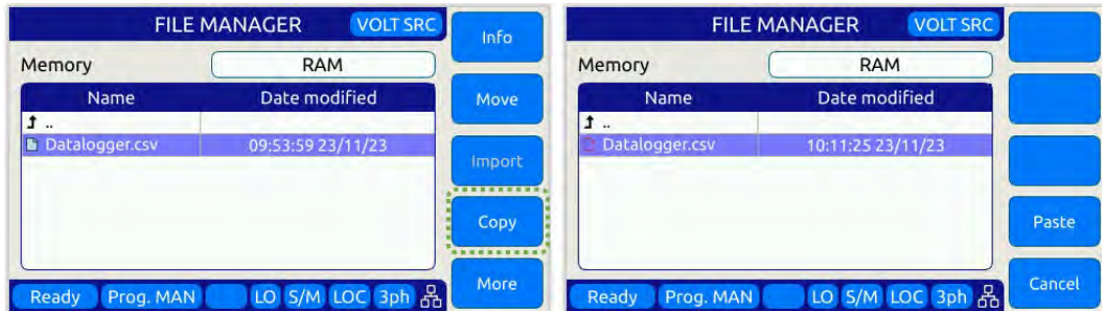
### Moving Files



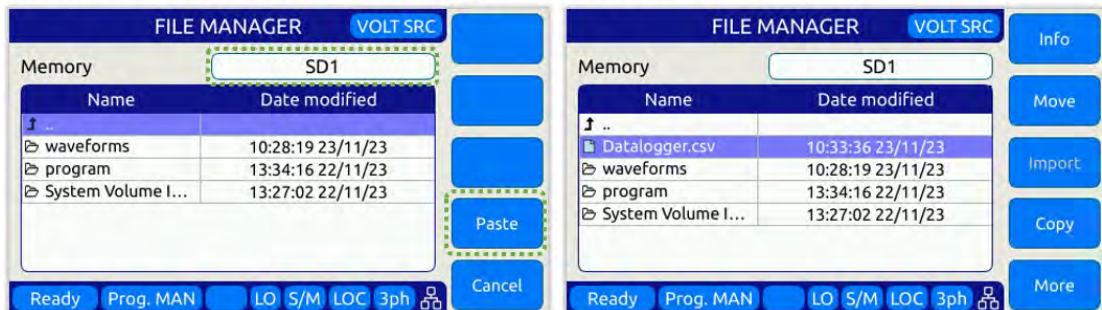
- Changes the directory and then press “Apply Move”



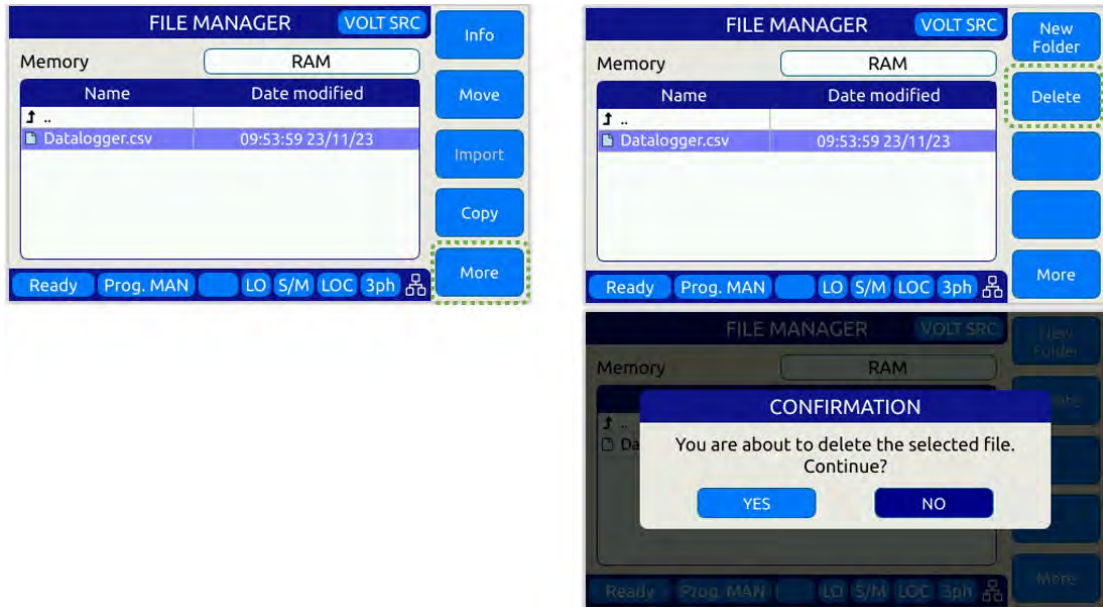
### Copy and Pasting Files



Changes the directory (and/or Memory) and then press “Paste”



**Deleting Files**



**6.8.10 CALIBRATION MENU Screen**

All power sources are shipped with a Certificate of Compliance to NIST traceable standards (“CoC”) from the factory. Output and Measurements are calibrated to an external reference DMM at the same time. A suitable current shunt or current transformer and a load will be required to perform calibration.

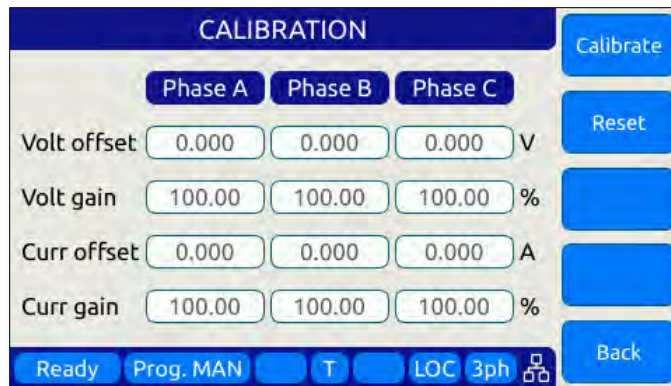


Figure 6-35: CALIBRATION MENU Screen

The following soft keys are available from the CALIBRATION MENU:

SOFT KEY	Description
<b>Calibrate (SK1)</b>	Enters calibration state
<b>Reset (SK2)</b>	Resets all calibration coefficients' previous values.
-	

SOFT KEY	Description
-	
<b>Back (SK5)</b>	Returns to previous screen

Table 6-37: Available CALIBRATION MENU screen soft keys

For details on calibration requirements and procedures, refer to the Calibration section towards the end of this manual. (Section 11, “Calibration”).

### 6.8.11 FIRMWARE UPDATE Screen

Firmware updates may be distributed via different media such as SD-Card, USB memory stick or on-line through Pacific’s FTP site. The FIRMWARE UPDATE screen provides the means for the end user to perform a firmware update.

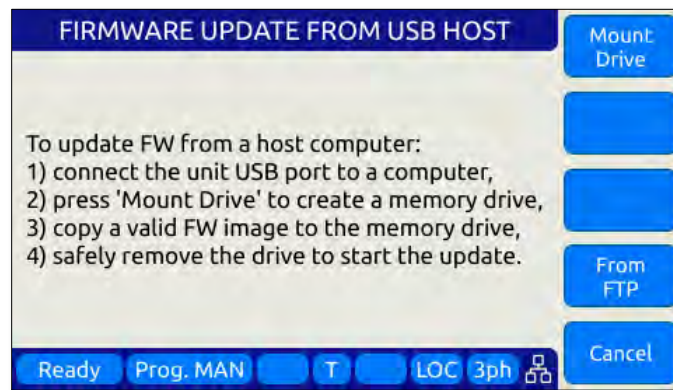


Figure 6-36: FIRMWARE UPDATE Screen

The following soft keys are available from the FIRMWARE UPDATE screen:

SOFT KEY	Description
<b>Mount Drive (SK1)</b>	Mount media that contains new firmware revision.
-	
-	
<b>From FTP (SK4)</b>	Install latest firmware from Pacific Power Sources’ FTP server.
<b>Cancel (SK5)</b>	Exit firmware update screen

Table 6-38: Available FIRMWARE UPDATE screen soft keys

### 6.8.12 REMOTE SUPPORT Screen

The REMOTE SUPPORT feature can be used to send information to customer support in case the user experiences an issue with the unit. It also provides a means to allow Pacific’s technical support team to access the unit remotely assuming it is connected to a network with Internet access.

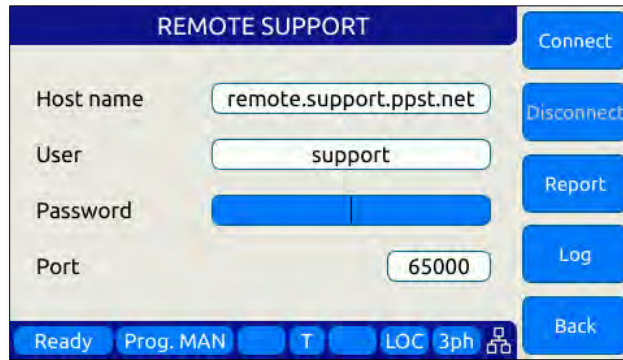


Figure 6-37: REMOTE SUPPORT Screen

The Report soft keys will cause a detailed report to be generated and sent to Pacific Power Source customer support so we can assist in resolving any technical support issues.

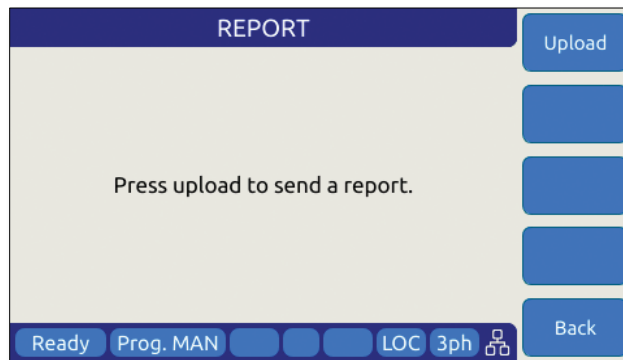


Figure 6-38: Remote Support REPORT Screen

The following soft keys are available from the LOGGING TOOL screen:

SOFT KEY	Description
<b>Connect (SK1)</b>	Connect to Pacific Power Support site
<b>Disconnect (SK2)</b>	Disconnect from Pacific Power Support site
<b>Report (SK3)</b>	Generates a report for Customer Support Department
<b>Log (SK4)</b>	Start Logging
<b>Back (SK5)</b>	Returns to the previous screen.

Table 6-39: Available LOGGING TOOL screen soft keys

## 7 Auxiliary I/O

### 7.1 Preface

This section describes the Auxiliary I/O functions of the LSX Series® AC power source.

### 7.2 Connector Location and Pin Designations

#### 7.2.1 DB25 Connector AUX I/O Pin Locations

The pin locations for the various I/O signals on the DB25 connectors are shown in Figure 7-1 below. Note that the connector is installed “Upside” down due to mounting constraints.



#### CAUTION: AMX AUX I/O COMPATABILITY

Note that while many signals are functionally equivalent to the AUX I/O signal on the legacy AMX Series power sources, the DB25 Connector pin assignment on the LSX Series is different from that on the AMX Series. **DO NOT USE EXISTING AMX WIRE CABLE HARNESES TO CONNECT TO AN LSX.** Instead, fabricate a new dedicated LSX cable harness.

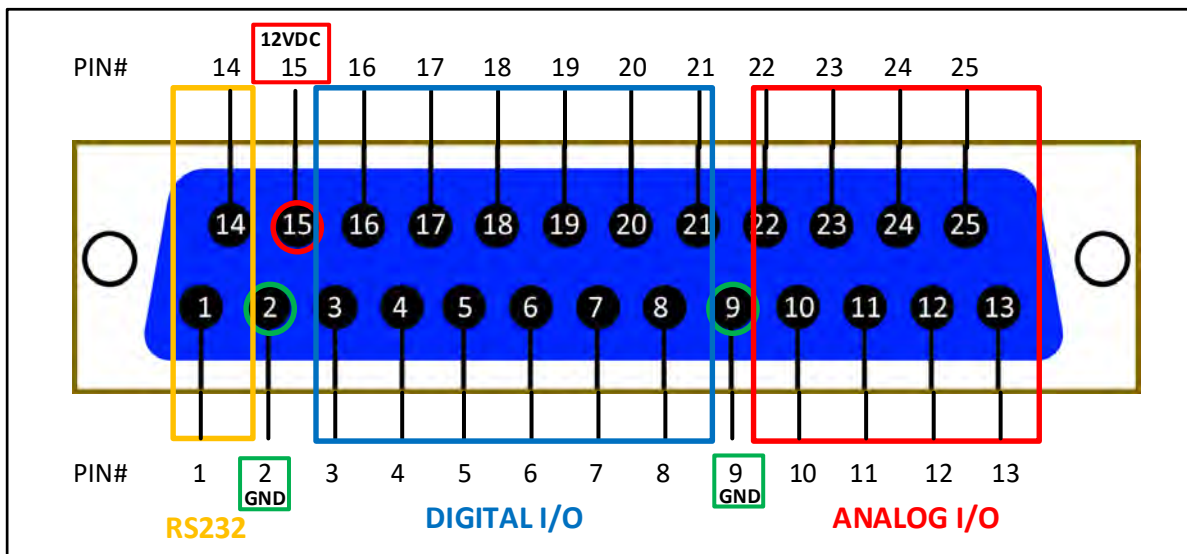


Figure 7-1: DB25 Connector AUX I/O Pin Locations

Functional grouping of pins by I/O function is done as shown in the figure above. The left hand side groups all **Analog I/O** signals on top on bottom row. The middle section is reserved for all **Digital I/O** pins. The **RS232** Transmit (Tx) and Receive (Rx) signals are located on the far right.



### 7.2.2 I/O Signal Table by pin number

Pin assignments in order of pin number are shown in the table below.

Pin #	Name	Primary Function	Alternate Use / Comment	Type	Direction
1	RxD	RS232 Receive Data (Rx)		RS232	Input
2	GND	Chassis Ground		Ground	n/a
3	DI1	General Purpose Digital Input #1	Programmable	Digital	Input
4	DI2	General Purpose Digital Input #2	Programmable	Digital	Input
5	DI3	General Purpose Digital Input #3	Programmable	Digital	Input
6	RI	Remote Inhibit	Short to +12Vdc Pin 15 to enable output.	Digital	Input
7	TT	Transient Trigger Input		Digital	Input
8	Sync In	Phase Sync Input		Digital	Input
9	GND	Chassis Ground		Ground	n/a
10	AI1	Analog Input – Volt RMS Phase A	Any set point	Analog	Input
11	AI2	Analog Input – Volt RMS Phase B	Any set point	Analog	Input
12	AI3	Analog Input – Volt RMS Phase C	Any set point	Analog	Input
13	AI4	Analog Input – Current Limit RMS all phases	Any set point	Analog	Input
14	TxD	RS232 Transmit Data (Tx)		RS232	Output
15	12V	Output, 12Vdc	0.5 A max, current protected	Power	Output
16	DO3 /RC1	Relay Control #1 – FORM	Programmable, Open Collector, Current protected	Digital	Output
17	DO4 /RC2	Relay Control #2 - TRANSFORMER	Programmable, Open Collector, Current protected	Digital	Output
18	FS	Trigger Output / Function Strobe		Digital	Output
19	Sync Out	Phase Sync Output		Digital	Output
20	DO1	General Purpose Digital Output #1	Programmable	Digital	Output
21	DO2	General Purpose Digital Output #2	Programmable	Digital	Output
22	AO1	Analog output #1 – Volt RMS Measurements Phase A	Any other measurement	Analog	Output
23	AO2	Analog output #2 – Volt RMS Measurements Phase B	Any other measurement	Analog	Output
24	AO3	Analog output #3 – Volt RMS Measurements Phase C	Any other measurement	Analog	Output
25	AO4	Analog output #4 – Total Power (all phases combined)	Any other measurement	Analog	Output

Table 7-1: Auxiliary I/O DB25 Connector Pin numbers and Signals by DB25 pin number

### 7.2.3 I/O Signal Table by Function

Pin assignments in order of pin number are shown in the table below.

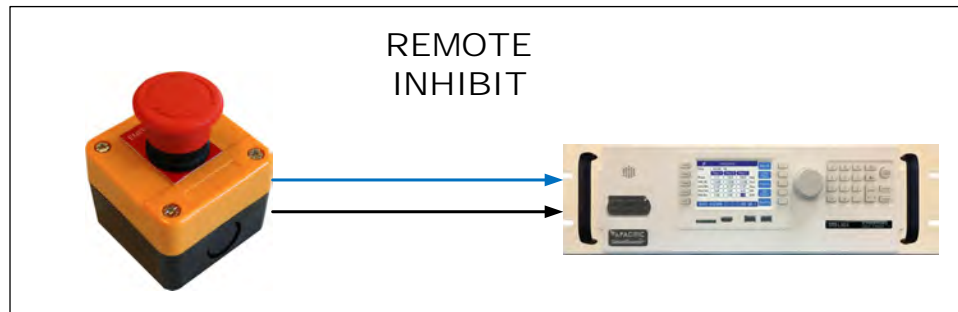
Pin #	Name	Primary Function	Alternate Use / Comment	Type	Direction
10	AI1	Analog Input – Volt RMS Phase A	Any set point	Analog	Input
11	AI2	Analog Input – Volt RMS Phase B	Any set point	Analog	Input
12	AI3	Analog Input – Volt RMS Phase C	Any set point	Analog	Input
13	AI4	Analog Input – Current Limit RMS all phases	Any set point	Analog	Input
22	AO1	Analog output #1 – Volt RMS Measurements Phase A	Any other measurement	Analog	Output
23	AO2	Analog output #2 – Volt RMS Measurements Phase B	Any other measurement	Analog	Output
24	AO3	Analog output #3 – Volt RMS Measurements Phase C	Any other measurement	Analog	Output
25	AO4	Analog output #4 – Total Power (all phases combined)	Any other measurement	Analog	Output
3	DI1	General Purpose Digital Input #1	Programmable	Digital	Input
4	DI2	General Purpose Digital Input #2	Programmable	Digital	Input
5	DI3	General Purpose Digital Input #3	Programmable	Digital	Input
20	DO1	General Purpose Digital Output #1	Programmable	Digital	Output
21	DO2	General Purpose Digital Output #2	Programmable	Digital	Output
18	FS	Trigger Output / Function Strobe		Digital	Output
16	DO3 /RC1	Relay Control #1 – FORM	Programmable, Open Collector, Current protected	Digital	Output
17	DO4 /RC2	Relay Control #2 - TRANSFORMER	Programmable, Open Collector, Current protected	Digital	Output
6	RI	Remote Inhibit	Short to +12Vdc Pin 15 to enable output	Digital	Input
8	Sync In	Phase Sync Input		Digital	Input
19	Sync Out	Phase Sync Output		Digital	Output
7	TT	Transient Trigger Input		Digital	Input
15	12V	Output, 12Vdc	0.5 A max, current protected	Power	Output
2	GND	Chassis Ground		Ground	n/a
9	GND	Chassis Ground		Ground	n/a
1	RxD	RS232 Receive Data (Rx)		RS232	Input
14	TxD	RS232 Transmit Data (Tx)		RS232	Output

*Table 7-2: Auxiliary I/O DB25 Connector Pin numbers and Signals by Signal Name*

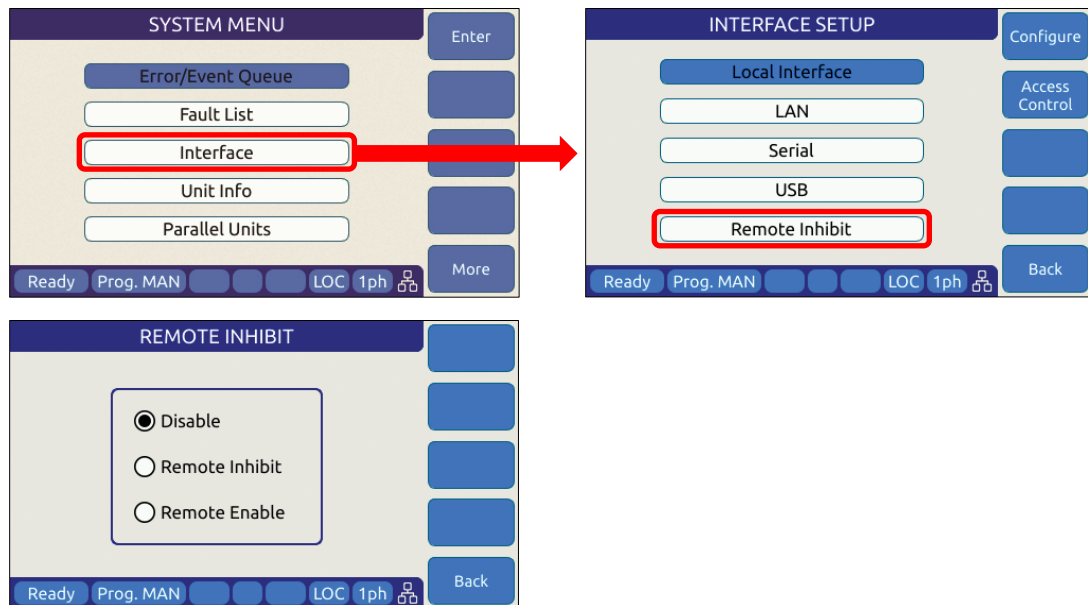
### 7.3 Dedicated Function Digital Inputs

- Remote Inhibit
- External Trigger Input
- External Phase Sync Input

#### 7.3.1 Remote Inhibit



The mode can be selected from the SYST (SYSTEM) menu screen using the Interfaces, Remote Inhibit selection as shown below.



There are three modes of operation for this input:

1. **Disable mode:** In this mode, the Remote Inhibit inputs are not active so this function is turned off. No short between the RI pins is required to enable the output in this mode.
2. **Remote Inhibit mode:** The two pins have to be shorted for the output to be enabled from the front panel or remote command. This is a necessary but not a sufficient

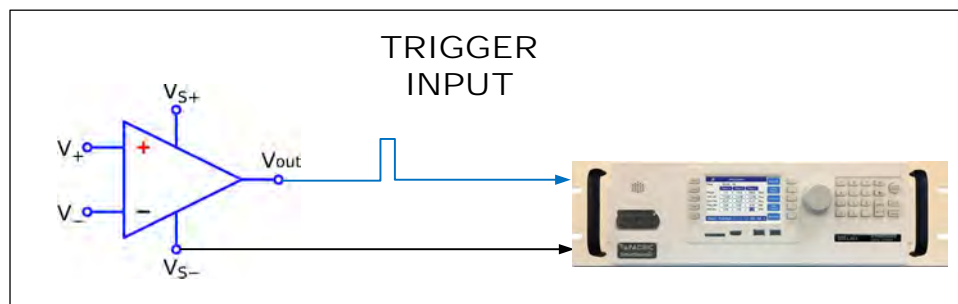
condition to enable the output. If the output is enabled and the remote inhibit connection is open, a fault is generated. This mode is recommended for interlock safety applications such as safety cages and test fixture interlocks.

Command: `SYSTEM:DIO:REMOte:INHibit 0 | 1`

3. **Remote Enable mode:** The output can be enabled by shorting these two pins, regardless of the output enable command/button. It is a sufficient condition to enable the output.

Command: `SYSTEM:DIO:REMOte:ENABle 0 | 1`

## 7.4 Transient Trigger Input



The external trigger input can be programmed to trigger the start of a transient program. This allows the power source output sequence to be initialized by an external sync signal.

In order to use the trigger input, the mode has to be active (from any of the graphical interfaces or using the SCPI command `PROGRAM:TRANSient:TRIGger:INput`), and the transient program has to be executed first. The transient will wait and start execution when a rising edge is detected on this digital input.

The graphical interfaces (front panel and webpage) will show the state “Running” but with a progress of 0% until the transient program is actually started.

The following specifications apply to the external trigger input:

Input Voltage	Logic Low $V_{in} < 0.4 \text{ V}$ Logic High $V_{in} > 2.0 \text{ V}$
Impedance	10 k $\Omega$
Edge Triggered	Rising edge

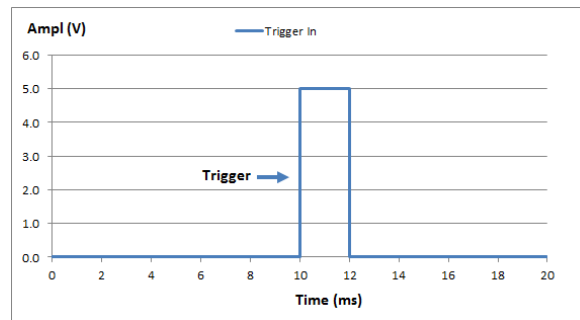


Figure 7-2: External Trigger Input Timing

## 7.5 External Sync Input

The phase sync input can be used to synchronize in frequency and phase the internal waveform generation of the LSX to an external sync reference. The reference must be within the specified frequency range of the power source and zero phase offset calibration for phase A may be required to compensate for any phase shifts. Note that Phase B and C are still referenced to phase A as programmed by B and C phase angles.

### 7.5.1 Principle of Operation

In External sync mode, the LSX uses the external sync input to synchronize phase A. The goal of the phase sync is to provide precise frequency synchronization, and consistent phase at a given operating point, but the phase shift between sync input and AC output is not automatically zero. A phase adjustment for Phase A must be made by the user to time-align the power source's phase A output voltage to the external sync input signal.

A couple of factors affect the phase shift:

- There can be a phase shift that depends on the output load because of the finite bandwidth of the output inverter stages. This is particularly visible at higher frequencies. At 50Hz or 60Hz, the phase shift will be pretty small.

**Note:** When the sync input is enabled, the LSX output frequency **must** be set to a value similar to the external sync signal. This minimizes the synchronization time and improves the stability of the generated frequency.

After the sync input is activated, or the external signal frequency/phase is changed, the Sync circuit's Phase Lock Loop (PLL) requires a short time to "lock" to the external source. The LSX reports the status of the PLL in the external interfaces (front panel and webpage) by showing a "**Synced**" or "**Unsynced**" message in the status bars. (See section 0 for details).

The status can also be queried with the SCPI command "SOURce:SYNChronize:STATE?".

The sync circuit is able to synchronize to any signal with a frequency if  $F_{\text{SETPOINT}} \pm F_{\text{RANGE}}$ , where  $F_{\text{SETPOINT}}$  is the normal frequency set point and  $F_{\text{RANGE}}$  is a configurable value (default is 10Hz)

The following specifications apply to the phase sync input at the DB25 port:

Input Voltage	Logic Low $V_{in} < 0.4\text{ V}$ Logic High $V_{in} > 2.0\text{ V}$
Impedance	10 k $\Omega$
Frequency Range	15 Hz – 1200 Hz
Edge Triggered	Rising edge

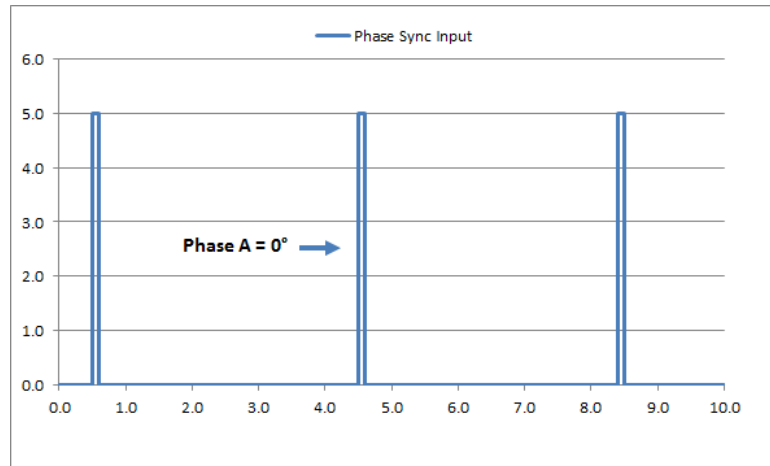


Figure 7-3: External Sync Input Pulses

### 7.5.2 SYNC Status Display

A “Synced” status field will be displayed in **Green** in the lower left corner of the LCD display. This field will toggle with the regular “Ready/Enabled/Fault” status field also shown in this location. The “Synced” status will be shown every 3 seconds for 1 second in place of the “Ready/Enabled/Fault” field. When the PLL is not locked to the external source, the unit will display an “Unsynced” status in **Orange**.

It is not recommended to enable the unit when it has not locked or synchronized to the external source because the frequency may be unknown.



Figure 7-4: External Sync Input Sync Status Indication



Figure 7-5: External Sync Input Sync Lost Status Indication

### 7.5.3 Sync Operation Settings

The LSX allows precise configuration of the synchronization parameters to optimize performance for each application. The parameters are:

- 1 **Phase shift:** Defines a fixed phase shift between phase A waveform generation and the external sync source. Used to calibrate any phase difference between the sync signal and the power source output on phase A.

Command: SOURCE:SYNChronize:PHASEshift

- 2 **Speed:** Allows accelerating the speed of the internal synchronization engine (PLL) in case the external sync source is not constant and presents periodic or continuous changes. A slower speed improves the stability of the waveform frequency, so it is recommended to use the smallest possible speed values.

Command: SOURce:SYNChronize:SPeEd

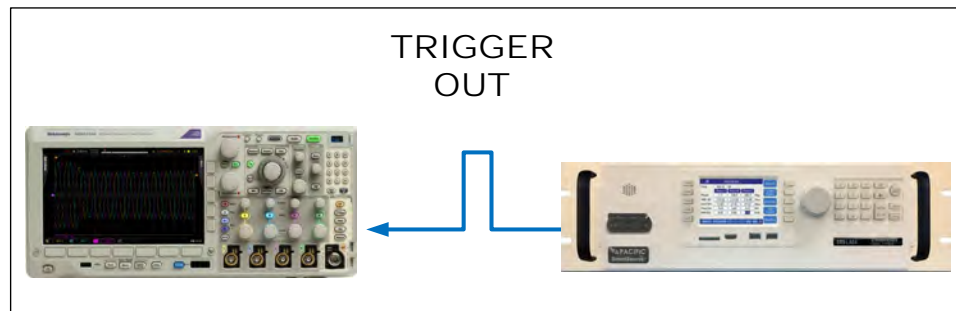
- 3 **Range:** Allows configuration of how much the synchronization engine is able to deviate from the LSX programmed frequency. This helps to keep the waveform frequency under control, even if the external source is not present all the time. The synchronization engine is limited to frequencies of FSETPOINT +/- FRANGE.

Command: SOURce:SYNChronize:RANGe

## 7.6 Digital Output control signals

- External Relay Control #1 - FORM
- External Relay Control #2 - TRANSFORMER
- Trigger Output / Function Strobe
- Phase Sync Output

### 7.6.1 Function Strobe / Trigger Out



The external trigger output can be programmed to generate an output pulse on the following events:

- a. The start of a transient program (Transient Trigger)
- b. Output Replay State Change
- c. Any parameter change. Parameter changes that generate an output function strobe pulse are:
  - i. Voltage on any phase
  - ii. Frequency
  - iii. Waveform on any phase
  - iv. Phase angle



The mode can be set from the front panel or by using the following SCPI commands:

Transient start mode:	SYSTEM:DIO:STROBE:TRANSient 0/1	
	PROGRAM:TRANSient:TRIGger:OUTput 0/1	(alias)
Output Relay mode:	SYSTEM:DIO:STROBE:OUTPutstate 0/1	
Program Change mode:	SYSTEM:DIO:STROBE:SOURce 0/1	

The following specifications apply to the external trigger output:

Output Voltage @ 0.4 mA	Logic Low Vout < 0.4 V	
	Logic High Vout > 4.6 V	
Max. Current	± 10 mA	
Output Impedance	100 Ω	
Pulse Width	190 us ± 10 us	For Transient Trigger mode
	2.0 msec ± 10 μs	For OUTPutstate & SOURce modes

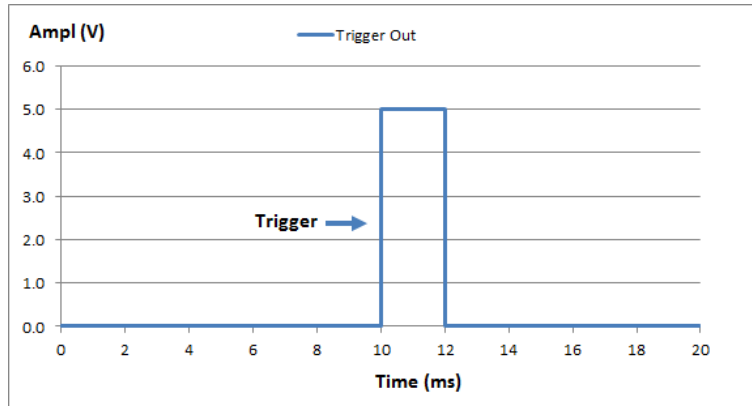


Figure 7-6: Transient Trigger Output Pulse

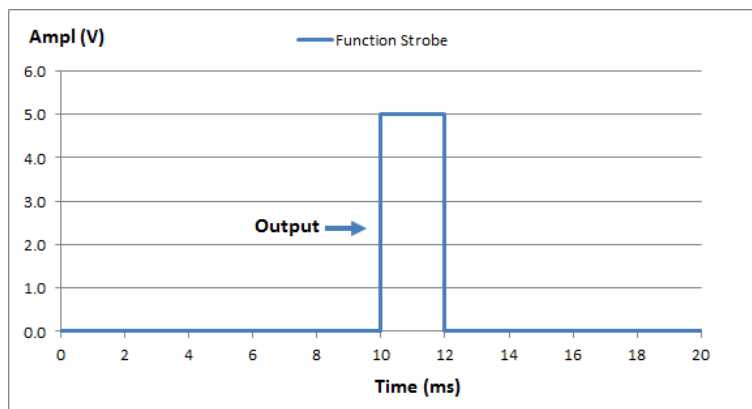
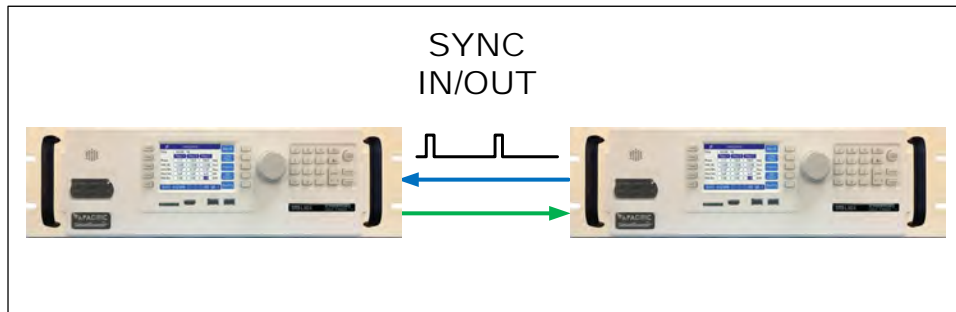


Figure 7-7: Function Strobe Output Pulse

### 7.6.2 Phase Sync Output / External Sync Output



The phase sync output or External Sync Output signal can be programmed to generate an output pulse at each zero crossing of the phase A voltage. This indicates the 0° phase angle output on Phase A.

The mode can be set from the front panel or by using the following SCPI commands:

The following specifications apply to the external trigger output:

Output Voltage @ 0.4 mA	Logic Low Vout < 0.4 V
	Logic High Vout > 4.6 V
Max. Current	± 10 mA
Output Impedance	100 Ω
Pulse Width	Programmable from 3 μs to 100000 μs (100 msec)
	Programmable polarity
	Auto 50% duty cycle mode available

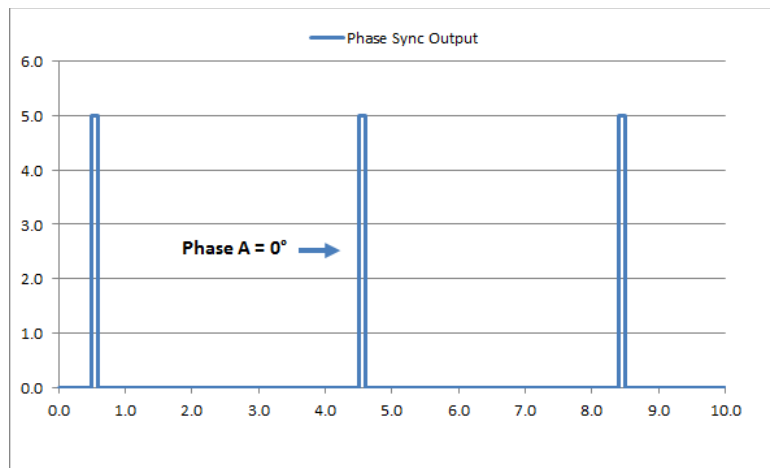
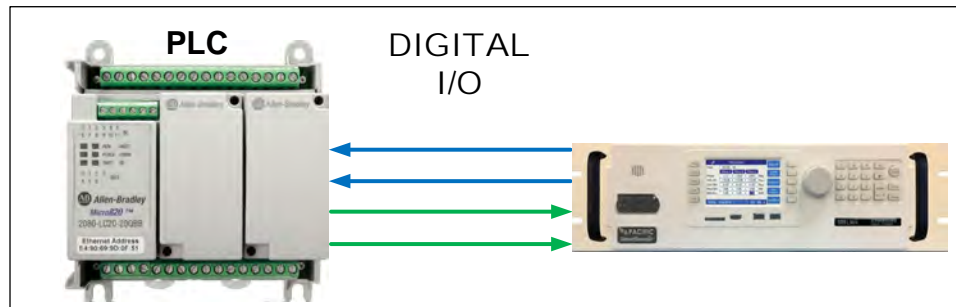


Figure 7-8: Phase A Zero Phase Sync Output Pulse

## 7.7 User Programmable Digital signals

Available user defined digital input and outputs are provided as part of the I/O feature. These signals may be assigned different purposes under software control.



User Programmable Digital Input signals functions are:

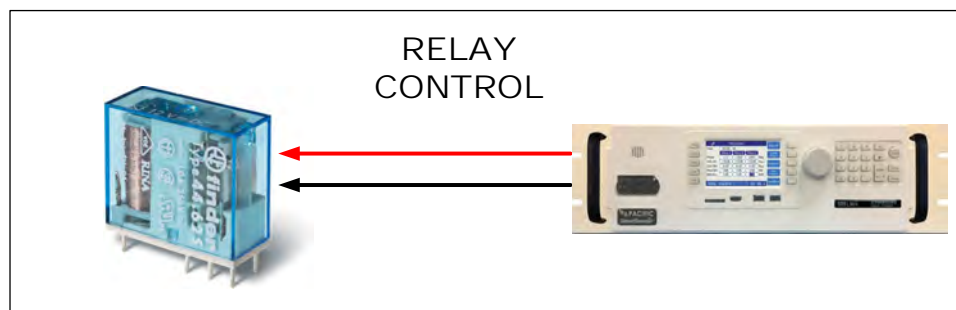
- DIO:INput1 - Digital Input #1
- DIO:INput2 - Digital Input #2
- DIO:INput3 - Digital Input #3

User Programmable Digital Output control signals are:

- DIO:OUTput1 - Digital Output – TTL level
- DIO:OUTput2 - Digital Output – TTL level
- DIO:OUTput3 - Digital Output – Open drain
- DIO:OUTput4 - Digital Output – Open drain

Digital outputs 3 and 4 are open drain with internal +5Vdc pull-ups.

### 7.7.1 Relay Control Outputs



The external relay control output signals DO3 and DO4 can be used to control external relays. These control lines are user programmable for difference functions such as FORM relay control and Transformer Option control.

These relays are used to either short all outputs together for single-phase output mode or to connect and disconnect and external transformer for a higher voltage AC output range.

- Relay signal #3 is normally used for the FORM (Mode Change) Relay option on LSX cabinet systems.
- Relay signal #4 is normally used for the Transformer Option.
- A 12V dc output is provided as well to drive a small signal relay to operate a large contactor.

### 7.7.2 Digital User Inputs

The digital inputs allow any action to be executed at the rising and/or falling edge of the signal, by simply assigning a SCPI command for execution to that event.

For example, a digital input can be configured to enable the output at the rising edge and disable it at the falling edge of the signal. Alternatively, it can be configured to change any set point and either of those 2 events.

A total of three digital inputs are available. These following input characteristics can be programmed for each digital input (1, 2 and 3):

- **Command** to execute (a SCPI command string) at each edge. Rising and falling edges can have different commands.
- **Filter** Setting, to reduce sensitivity to short pulses that can be caused by electrical noise or some mechanical switches.

See SCPI command section 8.10.1.3 for commands that configure and read digital inputs.

### 7.7.3 Digital User Outputs

There are four programmable digital outputs (1 to 4), which can be configured to change state based on different conditions:

- 1=ON, 0=OFF it is used as general-purpose digital output, with the value set with a SCPI command.
- OUTPUT\_STATE indicates output enabled (1) or disabled (0).
- FORM indicates single (1) or split/three (0).
- FAULT indicates fault (1) or no fault (0).
- TRANSIENT indicates when a transient is running/paused/stepping (1) or stopped (0).
- PROGRAM indicates when a program is in execution at steady state level (1) or manual mode (0).
- REMOTE indicates remote (1) or local (0).
- XFMR\_COUPLING indicates direct (0) or transformer (1) coupling. This output is relevant only when an output transformer option is installed and configured.

**Note:** Each output can be also configured to invert its logic.

User defined digital inputs can be queried using the SYSTEM:DIO:OUTput# command.

Digital outputs 1 and 2 are TTL level signals (0 to 5V), and digital outputs 3 and 4 are open-drain type outputs (with an internal pull-up) that can be used to drive external relays. Each open-drain output has a current protection of 0.5A and internal clamping diode prepared to drive a relay coil.

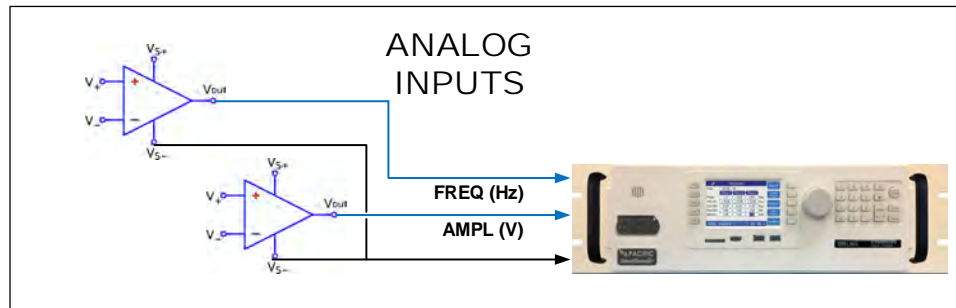
See section 8.10.1.4 for commands that configure and read digital outputs.

## 7.8 Analog I/O Descriptions

Both analog inputs and outputs are available on the AUX I/O feature. Analog inputs are used to change output parameters such as voltage or frequency. Analog outputs are provided to allow monitoring the LSX measurements using external equipment.

The analog inputs can be repurposed from level programming input to direct analog inputs as needed. Refer to section 7.9, “Analog Input Modes” on page 198 for details.

### 7.8.1 Analog Inputs



There are 4 analog inputs that accept DC signals up to 10Vdc and may be used to program the LSX output parameters such as voltage, frequency, current and power limits.

These inputs are sampled 20 times per second so updates of the assigned parameters occur at this rate. The full-scale range of the analog inputs can be programmed to be 5V, 10V or any value between 1 and 10V.

**Note:** Once enabled, make sure the input is not left floating or a small offset of about 2 to 3 % of full scale may be present affecting the programmed parameter. For example, when programmed to control AC voltage, no input on the analog input assigned will result in an output voltage of about  $0.02 \text{ to } 0.03 \times 300 = 6 \text{ to } 9 \text{ Vac}$ .

The full-scale value for voltage programming depends on the selected operating mode. A 10V input represents 300Vac RMS.

For frequency programming, 0V represents 15Hz while 10V represents 1200Hz.

These analog inputs are all disabled by default. In order to use this feature, each analog input has to be assigned to an LSX parameter and phase, for example AC voltage of phase A.

### 7.8.2 Programming Analog Inputs

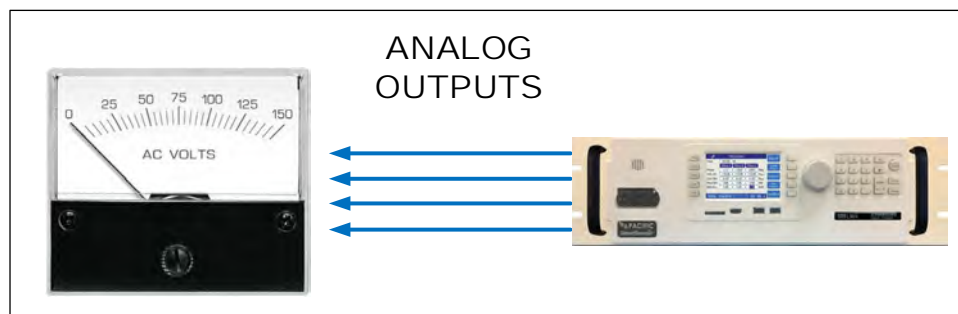
The range of the analog inputs can be changed with two parameters for each input, gain and offset. For example if an input is assigned to AC voltage programming the default gain is

300V and the offset is 0V. This means that 10V at the analog input port represents a programmed voltage of 300Vrms and 0V represents 0Vrms.

Different gain and offset combinations can be used to customize the range of the analog programming input, being the “gain” the programmed value that represents the maximum input at the analog port, and “offset” the value at 0V. For example, a gain of 150V and offset of 50V produce an output of 50V to 200V for analog programming signals of 0V to 10V.

**Note:** Different LSX parameters have different units (Volts, Amperes, Watts, Hertz, etc.), so when an analog input parameter is changed, the gain and offset are reset to default values (zero for offset and max full-scale values for gain).

### 7.8.3 Analog Outputs



Analog outputs are available to monitor output values for voltage, current or power using external measurement equipment. A total of four analog outputs are provided, with an output voltage range of 0 to 5V. Output scaling is fully programmable for each measurement with an offset and gain.

For example, for RMS voltage measurements the default gain is 300V and offset is 0V. This means that measurements of 0 to 300V generate monitoring voltages of 0 to 5V. An offset of 50V and a gain of 150V will mean that measurements in the range of 50 to 200V will be mapped to the analog output range of 0 to 5V.

Analog outputs are available to monitor output values for voltage, current or power using external measurement equipment. A total of four analog outputs are provided. Output scaling is from 0 to 10V for zero to full scale.

Pin #	Signal	Programs
22	AO1	Volt RMS Measurements Phase A
23	AO2	Volt RMS Measurements Phase B
24	AO3	Volt RMS Measurements Phase C
25	AO4	Total Power (all phases combined)

Table 7-3: Default Analog Output Functions

## 7.9 Analog Input Modes

The analog inputs support the following operating modes:

- Input off – Input disabled. In this mode, these same inputs may be used for level input programming per section 7.8.1, “Analog Inputs”, see page 197.

- Amplifier mode (AUX)– Fixed gain AC amplifier Mode
- Amplitude Modulation (AM) – Internal waveform amplitude is modulated with external analog signal.
- Analog Summing node (ADD) – Adds external input and internal waveform.

The gain of the analog input (one for each phase on three phase models) is as follows:

**For AUX and ADD modes:**

$$10V \text{ input} = 250V * \text{xfmr-ratio} \quad (\text{Same gain as PPS AMX Series})$$

**For AM mode:**

$$\text{Gain} = 1.0$$

Each mode is explained in more detail below.

7.9.1.1 Analog Input OFF

If no external input signal is used or no signal, it is best to turn these input off in case any unintended noise pickup on these inputs affects the internal waveform.

7.9.1.2 Amplifier Mode (AUX)

In amplifier mode, any analog AC input signal is amplified by the LSX amplifier(s). Internal programming references are ignored and the output amplitude is a fixed ratio time the input signal amplitude. Signal input range is  $\pm 10V_{pk}$ .

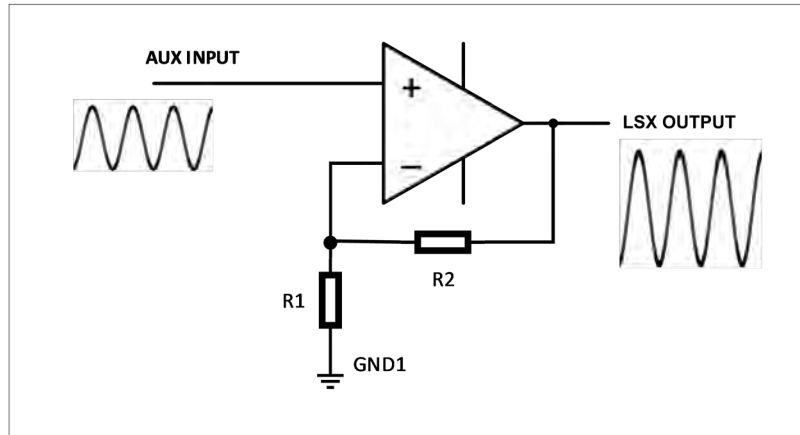


Figure 7-9: Analog Input Amplifier (AMP) Mode

Frequency of the input signal must be controlled by the user to not exceed the maximum output frequency at full-scale voltage.

**Note:** Internal regulation functions based on the LSX controller such as CSC mode are not in effect in this mode of operation.

### 7.9.1.3 Amplitude Modulation Mode (AM)

In AM mode, the internal control waveform amplitude is modulated by the external input signal. Signal input range is  $\pm 10V_{pk}$  and gain is 1.0 so max modulation depth is proportional to the analog input signal amplitude.

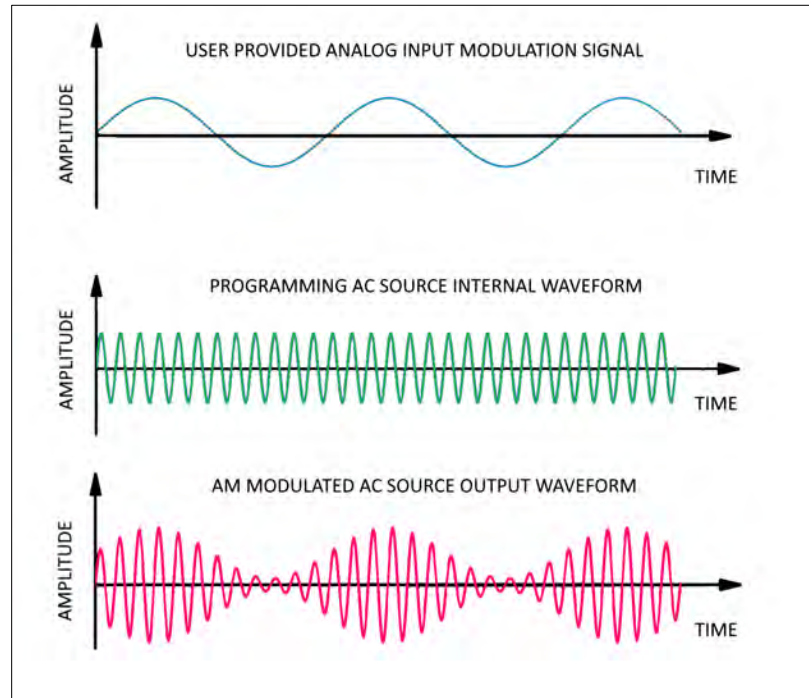


Figure 7-10: Analog Input Amplitude Modulation (AM) Mode

### 7.9.1.4 Analog Addition Mode (ADD)

In ADD mode, the external input signal is summed with the internal waveform reference and the sum of both signals is produced at the output of the LSX.

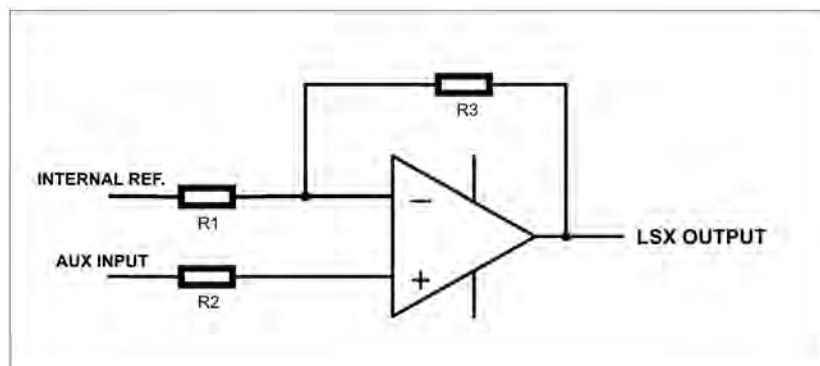


Figure 7-11: Analog Input ADD (Summation) mode



### 7.10 12 DC Power Supply

A pin in the DB25 port provides a current limited, regulated 12V supply. The maximum current capability is 0.5A dc.

There are no menus or commands associated with this output, as it is always active.

### 7.11 RS232 Description

The Tx and Rx signal on the AUX I/O connector may be used to connect to a serial port. Only Xon/Xoff handshake mode is supported on this RS232 port. For most situations, it is recommended to use the USB Device port for remote serial control applications.

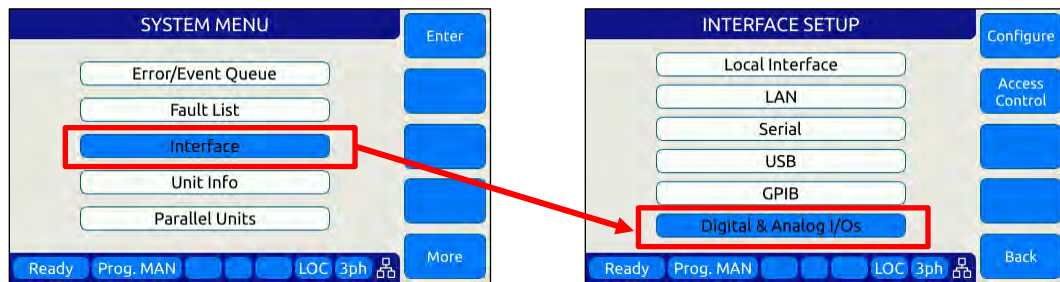
## 7.12 Front Panel Operation of AUX I/O Functions

The auxiliary I/O functions can be configured and programmed from the front panel using the SYSTEM menu (Press SYST key to left of the LCD screen). This section describes the available AUX I/O program screens and parameters for each function.

### 7.12.1 Accessing AUX I/O Screens.

From the SYSTEM MENU, scroll to the INTERFACE entry and press the shuttle or ENTER key as indicated below. If the Interface selection is not visible, press the “More” soft key to display the second System Menu screen.

Next, scroll to the “Digital & Analog I/Os” entry at the bottom of the INTERFACE SETUP screen.



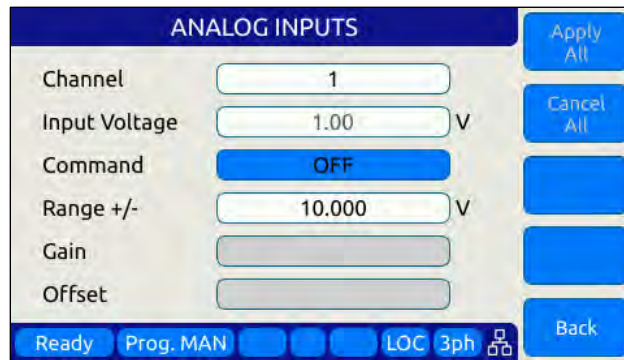
This will display a list of available Auxiliary I/O functions and features. To display the second of two DIGITAL & ANALOG I/Os screens, use the “More” soft key.



To select the desired function, use the knob to scroll up or down. Once selected, press the Shuttle knob or ENTER key to open the relevant I/O control screen.

Each screen is covered in the following sections in more detail.

### 7.12.2 Analog Inputs



Analog inputs allow parameters settings to be controlled using DC input signals. The parameter to be controller by each of four available analog inputs can be assigned from the front panel.

Available settings or read-outs and parameter ranges are:

- CHANNEL [ 1 | 2 | 3 | 4 ]
- INPUT VOLTAGE Displays read back voltage
- COMMAND Select command from dropdown list or OFF for none. See table below
- RANGE 0.0000 to 10.000 V
- GAIN Gain
- OFFSET Offset value

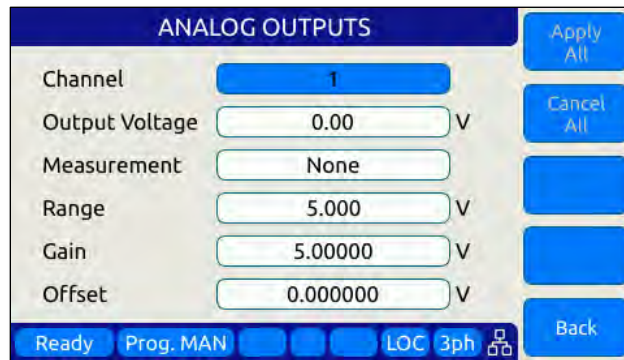
The **Command** parameter allows the user to assign the selected analog input to the parameter that will be controlled by it. The list of available setting commands for these inputs is shown below.

Analog Input Command Values					
VOLT:AC	n/a	CURR:LIM	FREQ	KVA:LIM	POW:LIM
VOLT:AC1	n/a	CURR:LIM1	PHAS2	KVA:LIM1	POW:LIM1
VOLT:AC2	n/a	CURR:LIM2	PHAS3	KVA:LIM2	POW:LIM2
VOLT:AC3	n/a	CURR:LIM3	OFF	KVA:LIM3	POW:LIM3

Table 7-4: AUX I/O Analog Input assignable Commands

The Gain and Offset parameters can be used to scale and shift the input value to the desired range for min. and max. output.

### 7.12.3 Analog Outputs

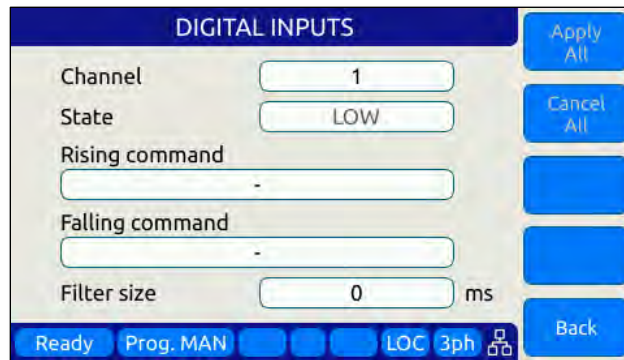


Analog outputs allow external equipment to monitor power source output values using an analog DC output signal. The assignment of measurement functions to each of four available outputs can be configured from the front panel.

Available settings are:

- CHANNEL [ 1 | 2 | 3 | 4 ]
- OUTPUT VOLTAGE Output setting
- MEASUREMENT Select measurement to be assigned to output
- RANGE 0.0000 to 5.000 V
- GAIN 0.000 to 1000
- OFFSET – 1000 to +1000

### 7.12.4 Digital Inputs

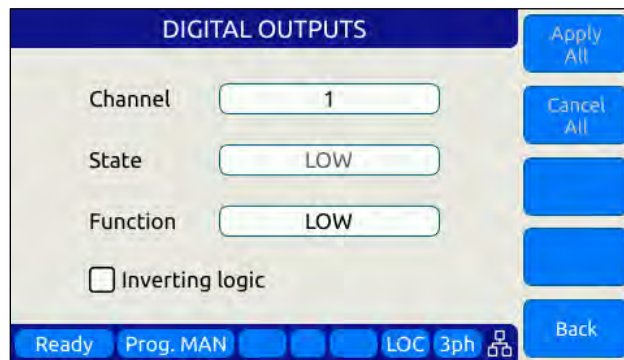


Digital Inputs allow external equipment such as PLCs. to control the power source operation. The assignment functions to each available input can be configured from the front panel.

Available settings are:

- CHANNEL [ 1 | 2 | 3 ]
- STATE Displays input state
- RISING CMD Set command string to execute on rising edge
- FALLING CMD Set command string to execute on falling edge
- FILTER SIZE 0 to 10,000,000 msec

### 7.12.5 Digital Outputs



Digital Outputs can be used to trigger or control external equipment. The events assignable to each digital output can be selected using the **Function** field.

Available settings are:

- CHANNEL [ 1 | 2 | 3 | 4 ]
- STATE Displays current state
- FUNCTION Assigns state to selected channel. Available states are:
- INV. LOGIC [ ON | OFF ] Reverses polarity

Events that can be assigned to digital outputs are listed in the table below and can be set using the **Function** field.

Digital Output Assignable Events		
EVENT	Description	Indication
FAULT	Output goes high on fault event	1 = Fault occurred, 0 = No Fault
FORM	Output FORM state	1 = SINGLE, 0 = SPLIT/THREE
HIGH	Fixed Output high	1 = ON
LOW	Fixed Output low	0 = OFF
OUTPUT STATE	Output Relay State	1 = ON (enabled), 0 = OFF (disabled)
PROGRAM	Output goes high when Program is selected	1 = Steady State Program, 0 = Manual mode
REMOTE	Output goes high when unit is in REMOTE state	1 = REMOTE state, -0 = LOCAL state
TRANSIENT	Output goes high when transient is running	1 = Running/Paused/Stepping, 0 = Stopped
XFMR_COUPLING	Indicates output coupling mode	1 = Transformer Coupled, 0 = Direct Coupled

*Table 7-5: AUX I/O Digital Output assignable Events or Conditions*

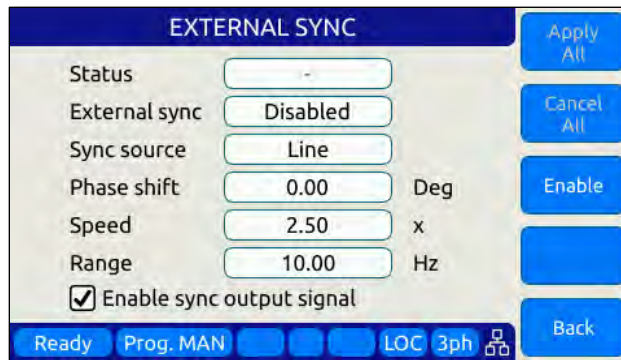
#### 7.12.6 Polarity Selection for DO3 and DO4 vs DO1 and DO2

The two open drain outputs DO3 and DO4 have internal 1 kΩ pull-up resistors to +5.5V. These outputs can be used as regular digital outputs (open-drain type) if needed. However, the logic will be inverted because a “direct” logic for the relay drive means an “inverted” logic for the open drain output. The FET being on means the relay coil active, but with a pull-up the output goes to low.

DO3 and DO4 use direct logic for the relay drive, which means that if the inverting logic is not active and there is a “1” written to the digital output, an internal FET will be activated causing a “low” in the open drain output.

Each digital output can be configured to have separate inverting logic, so the user can configure these 2 to be inverting and have the normal direct logic when used as open-drain outputs.

### 7.12.7 External Sync



External sync is used to synchronize the power source’s phase A output to an external frequency.

Available settings are:

- STATUS                      Display SYNC Status
- EXTERNAL SYNC          [ ON | OFF ]
- SYNC SOURCE              Select Sync source
- Available sync sources are:
  - External sync input on I/O connector
  - LINE (AC input to power source)
- PHASE SHIFT              Offset Phase A angle
- SPEED                      1.00 to 10.00
- RANGE                      0.10 to 1200 Hz
- EXTERNAL SYNC          [ ON | OFF ]

### 7.12.8 Trigger Input

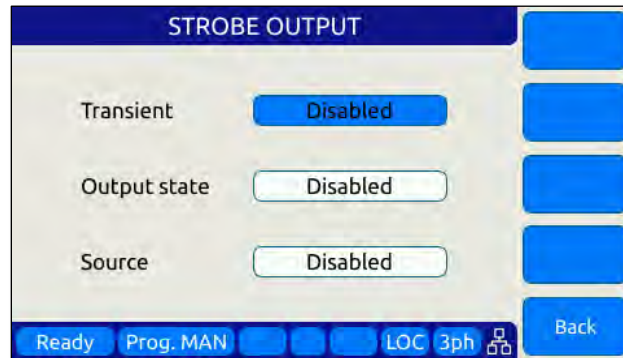


The External Trigger Input can be used to synchronize the power source’s transient execution to external equipment. This

Available settings are:

- STATUS [ ON | OFF ] Enabled or disabled
- IMMEDIATE [ ON | OFF ] Ignore phase update setting if ON
- AUTORUN [ ON | OFF ] No RUN command required if ON

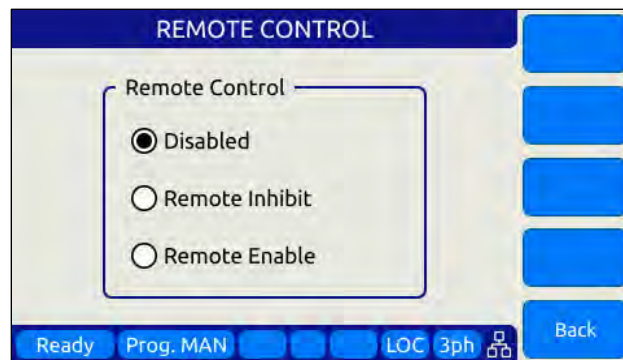
### 7.12.9 Strobe Output



The Strobe Output is used to synchronize or trigger external equipment to an event occurring on the AC power source. Available settings are:

- TRANSIENT ON = Strobe output on transient start
- OUTPUT STATE ON = Strobe output on relay close
- SOURCE ON = Strobe output on any program parameter change

### 7.12.10 Remote Control



The remote control input is used to control operation of the output relay.

Available settings are:

- DISABLED No remote output control
- REMOTE INHIBIT Contact closure needed to close output relay
- REMOTE ENABLE Contact closure or front panel can control output relay

See Section 6.8.5.6.



## 8 Remote Control Programming

### 8.1 Overview

If your unit is fitted with a computer interface option then RS232, USB or LAN connector will be present on the rear panel based on the order configuration. The interface allows the power source settings to be configured remotely and measurement data to be retrieved for analysis and test report generation.

The front panel LOCAL key allows the user to restore LOCAL CONTROL unless the Bus controller has sent a LOCAL LOCKOUT (LLO) message. The Bus Controller may restore LOCAL CONTROL by sending a GOTO LOCAL (GTL) message.

#### 8.1.1 Programming Conventions and Notations

The following conventions and notations are used in this section of the manual:

1. **COMMANDS** are shown in the left hand column in **BOLD** with **NO** underline.
2. Command **DESCRIPTIONS** appear in the right hand column.
3. SCPI is "Standard Commands for Programmable Instruments -1992". Refer to the SCPI 1992 standard for more information. The full standard publication is available from the IVI Foundation at <http://www.ivifoundation.org/>
4. Some SCPI keywords are optional, and are ignored by the device. Optional keywords are enclosed in [ ] brackets.
5. Lowercase letters of commands shown are also optional.
6. The SCPI standard requires uppercase text in all SCPI commands (start with : ), however, the command parser is not case sensitive and will accept commands sent in lower case. It is recommended that programming formats follow the SCPI standard.
7. Some SCPI commands have query command counterparts as noted. A query command consists of the command with a question mark ( ? ) appended at the end. Parameters cannot be sent with a query. IEEE-488.2 commands do not have query counterparts unless explicitly shown with a question mark appended.
8. IEEE488.2 common commands start with an asterisk ( \* ) and are not case sensitive.
9. All required Functional Elements for devices are implemented.
10. All numerical values are ASCII encoded decimal strings consisting of 1 or more ASCII digits. 8 and 16 bit register values are binary weighted values represented by an ASCII string of 1 or more decimal digits. One exception, the Serial Poll byte, is an 8 bit hexadecimal byte.
11. Multiple Commands and Queries may be sent in one Program Message but each must be separated by a semicolon ( ; ). The term 'Program Message' refers to one or more

commands and/or queries sent to the controller as one continuous string and is not to be confused with Stored Programs (1-99) within the controller.

12. Multiple data parameter names and values must be separated by commas.
13. Voltage and Waveform parameter names without a channel number suffix (1,2,3) may be used to set all 3 channels (phases) simultaneously, as an alternative to setting each separately to the same value.
14. Multiple keyword messages may be sent without duplicating the first level SCPI keyword i.e., SOURce).  
e.g., :SOURce:VOLTage1,120; FREQuency,60  
A keyword is a single word beginning with a colon (:).
15. Program Messages MUST be terminated with a LINE FEED (0Ahex, 10dec) or END (EOI) signal. This is referred to as an end-of-string <eos>. A Carriage Return character (0Dhex, 13dec) is converted to a LINE FEED by the power source. Further SCPI commands shall begin with a first level keyword (i.e.,:SOURce:).
16. All values shown in angle brackets <> are examples of real values used with commands but labels are sometimes used to indicate a variable which is not known until actual time of use. e.g., <AMPS meter range> might actually be <50>. Units such as AAC, Hz. or % shown after the angle bracketed value are not to be included inside the value, but are shown as a reference to the units. The angle brackets are not part of the value.
17. The controller data input buffer is 8k bytes, as is its data output buffer. No program message may exceed this length.
18. All :SOURce: commands also support queries. An alternate method of writing or reading the presently active :SOURce:FORM, COUPLing, VOLTage, FREQuency, and CURRent:LIMit values is to use PROGram 0 (see examples). PROGram 0 contains the MANUAL MODE parameters.

**NOTE:** Sending any :SOURce: command invokes MANUAL MODE and REMOTE CONTROL.

19. Command strings may contain spaces.
20. The controller interface accepts IEEE-488.2 <nr1>, <nr2> and <nr3> numeric formats. Most query responses are <nr1> or <nr2> types. i.e., <nr1>=120, <nr2>=120.0, <nr3>=1.2E+02.
21. Follow any command (in the same Program Message) with \*OPC to detect completion of the command or termination of a Transient event. An SRQ occurs when the command or Transient is complete (if ESB bit is set in SRE and OPC bit is set in ESE). \*OPC? may be used in the same manner.

### 8.1.2 Command Terminators

Allowable terminator characters are:

Character	ASCII	Dec value	Hex value
Carriage Return	<CR>	13	0x0d
Line Feed	<LF>	10	0x0a

## 8.2 Remote Control Command Descriptions by Subsystem

This section covers detailed description of the available commands by category. The following command categories are defined.

Command Subsystem	Description
<b>CALIBRATE</b>	These commands perform calibration functions
<b>MEASURE</b>	These commands are used to measure voltage, current, power and any other measurement parameters from the instrument.
<b>OUTPUT</b>	These command control the power source output
<b>PROGRAM</b>	These commands control programmed settings and transient segments
<b>SENSE</b>	These commands control the voltage sense modes
<b>SOURCE</b>	These commands are used to set instrument settings
<b>STATUS</b>	These commands are used to control or query status and error messages.
<b>SYSTEM</b>	These commands are used to control system level setting such as interfaces, special operating modes or other special instrument specific functions.

Table 8-1: Available SCPI Command Subsystems

## 8.3 Calibration Commands

Calibration commands allow for fully automated calibration of the power source.

**Note:** It is not recommended for the end user to use these command unless calibration must be automated. Any errors in using these commands could invalidate user calibration data. Pacific Power Source recommends the use of a competent and authorized calibration lab to perform routine calibration.

The following calibration commands are supported. Commands marked “UPC” are provided for backward compatibility with UPC controller based PPS power sources.

### 8.3.1 LSX Calibration Commands

Command Syntax	<b>CALibrate:COEFFicients:OFFSET:VOLTage</b>
Description	Calibrates output DC voltage offset to lowest possible level.
Parameters	None
Parameter Format	n/a
Example	CAL:OFFSET:VOLT

Command Syntax	<b>CALibrate:COEFFicients:OFFSET:CURRent</b>
Description	Calibrates output DC current offset to lowest possible level
Parameters	None
Parameter Format	n/a
Example	CAL:OFFSET:CURR

Command Syntax	<b>CALibrate:COEFFicients:NOISE:VOLTage</b>
Description	Calibrates output voltage noise to lowest possible level.
Parameters	None
Parameter Format	n/a
Example	n/a

Command Syntax	<b>CALibrate:COEFFicients:NOISE:CURRent</b>
Description	Calibrates output current noise to lowest possible level.
Parameters	None
Parameter Format	n/a
Example	n/a

<p>Command Syntax Description</p>	<p><b>CALibrate:COEFFicients:GAIN:VOLTage[:AC] &lt;cr&gt;</b> Loads values measured with an external DVM for calibration of AC voltage output and metering. The first 3 values are Voltages measured at the output relay of the power source for each phase. The second set of 3 values are Voltages measured at the external voltage sense points (at the load) for each phase.</p>
<p>Parameters Parameter Format Example</p>	<p>External reference voltage readings for each phase n/a n/a</p>
<p>Command Syntax Description</p>	<p><b>CALibrate:COEFFicients:GAIN:CURREnt[:AC] &lt;cr&gt;</b> Loads values measured with an external shunt and DVM for calibration of AC current metering. The first 3 values are currents measured at the output of the power source for each phase.</p>
<p>Parameters Parameter Format Example Query Format Returned Data Format Query Example</p>	<p>External reference current reading n/a n/a No n/a n/a</p>
<p>Command Syntax Description</p>	<p><b>CALibrate:RESET</b> Clears all calibration coefficients. Sending this command resets all calibration factors to defaults. After sending this command, programming and metering remains functional and will still meet spec.</p>
<p>Parameters Parameter Format Example</p>	<p>None n/a CAL:RESET</p>
<p>Query Format Description Returned Data Format Query Example</p>	<p><b>CALibrate:COEFFicients:ALL?</b> Returns all eighteen calibration factors as a comma delimited list. &lt;nr1&gt;,...,&lt;nr1&gt; CAL:FACT:ALL? 0,0,0,0,0,0,0,0,0,0,0,0,0,0,0,0,0</p>
<p>Command Syntax Description</p>	<p><b>CALibrate:UPDATE</b> Transfers cal factors from XML Calibration file to NVM. Required only if calibration.xml has been modified. Alternatively, the unit can be power cycled.</p>
<p>Parameters Parameter Format Example</p>	<p>None n/a n/a</p>

### 8.3.2 UPC Specific commands.

Following commands are included for UPC compatibility mode only and don't perform any function other than providing query responses for use with legacy software programs.

Query Format	<b>CALibrate:VALue:XFMRRatio?</b>
Query Format	<b>CALibrate:VALue:AMPLIFIERS?</b>
Command Syntax	<b>CALibrate:KFACTORS</b> <k_int_Va, k_int_Vb, k_int_Vc, k_ext_Va, k_ext_Vb, k_ext_Vc, k_la, k_lb, k_lc, k_osca, k_oscb, k_oscC>
Query Format	<b>CALibrate:KFACTors:ALL?</b>

### 8.3.3 AUX I/O Interface Calibration Commands

For a list of AUX I/O calibration commands, see Section 8.10.4, on page 381.

## 8.4 Measurement Commands

Measurement commands are typically queries only and return power source measurement data values. This section is broken down into the commands for each measurement parameter.

The following measurement commands are supported.

### 8.4.1 Voltage Measurement Commands

Query Format	<b>MEASure:VOLTage[:ACDC]#?</b>
Description	Returns the measured RMS voltage for the selected phase #. If no phase number is specified, returns the reading for the last selected phase.
Returned Data Format	<nr2>
Query Example	MEAS:VOLT:ACDC2? 230.0000
Query Format	<b>MEASure:VOLTage:AC#?</b>
Description	Returns the measured RMS voltage for the selected phase #. If no phase number is specified, returns the reading for the last selected phase. This command is equivalent to “MEASure:VOLTage[:ACDC]#?” and is provided for backward compatibility with the UPC controllers.
Returned Data Format	<nr2>
Query Example	MEAS:VOLT:AC3? 230.0000
Query Format	<b>MEASure:VLL#?</b>
Description	Returns the measured RMS Line-to-Line voltage <sup>1</sup> for the selected phase #. If no phase number is specified, returns the reading for the last selected phase. Phase reference applies as follows: # = 1 V <sub>AB</sub> , # = 2 V <sub>AC</sub> , # = 3 V <sub>BC</sub>
Returned Data Format	
Query Example	MEAS:VLL2? 398.3780

**Note 1:** Line to Line voltage measurements are calculated based on VLN and phase angles and are valid only for sinusoidal voltage waveforms with low levels of distortion and under balanced three phase load conditions.

### 8.4.2 Frequency Measurement Commands

Query Format	<b>MEASure:FREQuency#?</b>
Description	Returns the fundamental frequency for the selected phase #. If no phase number is specified, returns the reading for the last selected phase. For frequency measurements, the phase reference is irrelevant as all phase are at the same frequency.
Returned Data Format	<nr2>
Query Example	MEAS:FREQ? 50.0000

### 8.4.3 Current Measurement Commands

Query Format	<b>MEASure:CURRent[:ACDC]#?</b>
Description	Returns the measured RMS current for the selected phase #. If no phase number is specified, returns the reading for all phases.
Returned Data Format	<nr2>
Query Example	MEAS:CURR:ACDC1? 21.1587

Query Format	<b>MEASure:CURRent:PEAK#[:ABSolute]?</b>
Description	Returns the measured peak current value for the selected phase #. If no phase number is specified, returns the reading for all phases.
Returned Data Format	<nr2>
Query Example	MEAS:CURR:PEAK? 45.5845, 47.3213, 48,2234

Query Format	<b>MEASure:CURRent:PEAK#[:ABSolute]:HOLD?</b>
Description	Returns the measured peak hold current value for the selected phase #. If no phase number is specified, returns the reading for all phases. This reading accumulates the highest recorded absolute peak current until reset using the MEASure:CURRent:PEAK#:RESet command.
Returned Data Format	<nr2>
Query Example	MEAS:CURR:PEAK:HOLD? 58.5845, 57.3213, 58,2234

Query Format	<b>MEASure:CURRent:PEAK#:MINimum?</b>
Description	Returns the lowest measured peak current value for the selected phase #. If no phase number is specified, returns the reading for all phases.
Returned Data Format	<nr2>
Query Example	MEAS:CURR:PEAK:MIN? 1.0001, 0.8451, 0.4871



<p>Query Format Description</p>	<p><b>MEASure:CURRent:PEAK#:MINimum:HOLD?</b> Returns the lowest measured peak hold current value for the selected phase #. If no phase number is specified, returns the reading for all phases. This reading accumulates the lowest recorded absolute peak hold current until reset using the MEASure:CURRent:PEAK#:RESet command.</p>
<p>Returned Data Format Query Example</p>	<p>&lt;nr2&gt; MEAS:CURR:PEAK:MIN:HOLD? 1.0001, 0.8451, 0.4871</p>
<p>Query Format Description</p>	<p><b>MEASure:CURRent:PEAK#:MAXimum?</b> Returns the highest measured peak current value for the selected phase #. If no phase number is specified, returns the reading for all phases.</p>
<p>Returned Data Format Query Example</p>	<p>&lt;nr2&gt; MEAS:CURR:PEAK:MAX? 45.5845, 47.3213, 48,2234</p>
<p>Query Format Description</p>	<p><b>MEASure:CURRent:PEAK#:MAXimum:HOLD?</b> Returns the highest measured peak hold current value for the selected phase #. If no phase number is specified, returns the reading for all phases. This reading accumulates the highest recorded absolute peak hold current until reset using the MEASure:CURRent:PEAK#:RESet command.</p>
<p>Returned Data Format Query Example</p>	<p>&lt;nr2&gt; MEAS:CURR:PEAK:MAX:HOLD? 58.5845, 57.3213, 58,2234</p>
<p>Command Syntax Description</p>	<p><b>MEASure:CURRent:PEAK#:RESet</b> This command resets all peak hold current readings for the selected phase # to zero. If no phase number is specified, returns the reading for all phases.to zero.</p>
<p>Parameters Parameter Format Example</p>	<p>None n/a MEAS:CURR:PEAK1:RES</p>
<p>Query Format Description</p>	<p><b>MEASure:CURRent:CREST#?</b> Returns the measured current crest factor for the selected phase #. If no phase number is specified, returns the reading for all phases.</p>
<p>Returned Data Format Query Example</p>	<p>&lt;nr2&gt; MEAS:CURR:CREST1? 2.1544</p>

Query Format	<b>MEASure:CURRENT:AC#?"</b>
Description	Returns the measured RMS current for the selected phase #. If no phase number is specified, returns the reading for all phases. This command is equivalent to "MEASure:CURRENT[:ACDC]#?" and is provided for backward compatibility with the UPC controllers.
Returned Data Format	<nr2>
Query Example	MEAS:CURR:AC1? 21.1587

#### 8.4.4 Power Measurement Commands

Query Format	<b>MEASure:POWER#?</b>
Description	Returns the true power for the selected phase # in kW. If no phase number is specified, returns the reading for the last selected phase.
Returned Data Format	<nr2>
Query Example	MEAS:POWER1? 4.4203

Query Format	<b>MEASure:KVA#?</b>
Description	Returns the true apparent for the selected phase # in kVA. If no phase number is specified, returns the reading for the last selected phase.
Returned Data Format	<nr2>
Query Example	MEAS:KVA1? 4.8665

Query Format	<b>MEASure:PF#?</b>
Description	Returns the true apparent for the selected phase # in kVA. If no phase number is specified, returns the reading for the last selected phase.
Returned Data Format	<nr2>
Query Example	MEAS:PF1? 0.9083

#### 8.4.5 KWh Measurement Commands

Query Format	<b>MEASure:KWHour#?</b>
Description	Returns the accumulated energy measurement for the selected phase # in kWh. If no phase number is specified, returns the total summed kWh for all phases.
Returned Data Format	<nr2>
Query Example	MEASure:KWHour? 12.4203

Command Syntax	<b>MEASure:KWHour:RESET</b>
Description	This command resets all energy measurements to zero and resets the time counter.
Parameters	None
Parameter Format	n/a
Example	MEAS:KWH:RESET
Query Format	<b>MEASure:KWHour:ETIME?</b>
Description	This command returns the accumulated energy measurement time in seconds.
Returned Data Format	<nr2>
Query Example	MEAS:KWH:ETIM? 120.5
Command Syntax	<b>MEASure:KWHour[:STATe] &lt;b&gt;</b>
Description	This command enables or disables the KWh measurements. When enabled, the energy time counter starts till reset with the MEASure:KWHour:RESET command.
Parameters	< 1   ON   0   OFF >
Parameter Format	<b>
Example	MEAS:KWH ON
Query Format	<b>MEASure:KWHour[:STATe]?</b>
Description	The query format of this command returns the setting of the KWh measurement as either 1 (ON) or 0 (OFF).
Returned Data Format	<nr1>
Query Example	MEAS:KWH? 1

### 8.4.6 Other Measurement Commands

Query Format **MEASure:TEMPerature:AMBient?**  
 Description Returns the ambient temperature of the power source in degrees celcius.  
 Returned Data Format <nr1>  
 Query Example MEAS:TEMP:AMB?  
 24

Query Format **MEASure:ALL#?**  
 Description Returns 14 parametric measurements for the selected phase # as a comma delimited string. The # is used to specify phase A, B or C using 1, 2 or 3 respectively. If phase reference is omitted, measurement data for all three phases is returned. Value order for each phase is:

All Firmware Revisions	
1. Frequency (repeats for each phase)	2. VLL AC+DC
3. VLL AC RMS	4. VLL DC
5. VLN AC+DC	6. VLN AC
7. VLN DC	8. I AC
9. I DC	10. POWER
11. APP POWER	12. I PEAK
13. PF	14. CF
FW Rev 3.3.12 or higher	
15. PEAK CURRENT	16. VOLTAGE THD
17. CURRENAT THD	18. PF Angle
19.DISPLACEMENT FACTOR	20. DISTORTION FACTOR
21. kWH	22. Elapsed Time for KWH

Thus, each phase data set consists of 14 values. For all phases, a total of 42 comma separated values are returned.

Returned Data Format <nr2>,<nr2>,...,<nr2>,<nr2>  
 Query Example MEAS:ALL1?  
 1200.0000,519.5981,519.5981,0.0028,299.9990,299.9989,-0.0007,0.1711,-0.0016,0.0000,0.0513,0.4849,0.0000,0.0000

Query Format **MEASure:ALL:CATALOG?**  
 Description Returns a comma-separated human-readable list of available measurements in the same order as the command returns it. See MEASure:ALL#? Command for parameter list as a function of Firmware revision. (FW Revisions 3.3.13 or higher)

Query Format **MEASure:ALL#? <OPTIONAL: List of measurements to return>**  
 Description Same as MEASure:ALL#? Command with optional user specified parameters list. Query command returns measurement parameters as included in list in the order they are specified by the list. (FW Revisions 3.3.13 or higher)

### 8.4.7 Measurement Data Logging Commands

Command Syntax	<b>MEASure:LOGger:START</b>
Description	Starts the logging of measurements process. The process consists of taking measurements and saving them in a file. The log file can be found in the “datalogger” folder and is a comma separated value format (.csv) file. Measurements will be taken while the output is enabled only.
Parameters	None
Parameter Format	n/a
Example	MEAS:LOG:START
Query Format	None
Command Syntax	<b>MEASure:LOGger:STOP</b>
Description	Stops the logging process that was started with MEASure:LOGger:START.
Parameters	None
Parameter Format	n/a
Example	MEAS:LOG:STOP
Query Format	None
Query Format	<b>MEASure:LOGger:STATe?</b>
Description	Returns the state of the measurement data logging process as a number as follows: 0 – Stopped 1 – Running 2 – Paused
Returned Data Format	<nr1>
Query Example	MEAS:LOG:STAT? 1

<p>Command Syntax Description</p>	<p><b>MEASure:LOGger:LIMit &lt;cr&gt;</b> Sets the number of samples to get. Once the logging process reach this limit it will stop.If the limit is set as OFF or 0 it will not stop unless MEAS:LOG:STOP is executed. The limit can be specified as a number of samples or in seconds if a character "S" is added to the number. If the limit is passed as seconds, the command will compute the number of samples based on the logging rate. The formula is: number of samples = seconds / rate. The rate can be set with: MEASure:LOGger:RATE &lt;nr1&gt; or queried with: MEASure:LOGger:RATE?. &lt; OFF   0 &gt; XS where X is a time limit in seconds X where X is the limit in number of samples</p>
<p>Parameters</p>	
<p>Parameter Format Examples</p>	<p>&lt;cr&gt; MEAS:LOG:LIM OFF MEAS:LOG:LIM 20S MEAS:LOG:LIM 100</p>
<p>Query Format Returned Data Format Query Example</p>	<p><b>MEASure:LOGger:LIMit?</b> 0 MEAS:LOG:LIM? 10000</p>
<p>Command Syntax Description</p>	<p><b>MEASure:LOGger:FILELimit &lt;nr1&gt;</b> Sets the limit of samples to save in the file. If the limit is reached and the logging process continues, a new file will be created.</p>
<p>Parameters</p>	<p>Limit in number of samples.</p>
<p>Parameter Format Example</p>	<p>&lt;nr1&gt; MEAS:LOG:FILEL 100</p>
<p>Query Format Returned Data Format Query Example</p>	<p><b>MEASure:LOGger:FILELimit?</b> &lt;nr1&gt; MEAS:LOG:FILEL? 10000</p>
<p>Command Syntax Description</p>	<p><b>MEASure:LOGger:FILENAME &lt;cr&gt;</b> Sets the data logging file name</p>
<p>Parameters</p>	<p>Filename between double quotes</p>
<p>Parameter Format Example</p>	<p>&lt;cr&gt; MEAS:LOG:FILEN "Measurement-AC"</p>
<p>Query Format Returned Data Format Query Example</p>	<p><b>MEASure:LOGger:FILENAME?</b> &lt;cr&gt; MEAS:LOG:FILEN? Measurement-AC</p>

<p>Command Syntax Description</p>	<p><b>MEASure:LOGger:MEMory &lt;cr&gt;</b> Select the memory where the logging files will be saved. By default it is RAM unless a memory stick or USB drive was inserted and selected with this command: MEAS:LOG:MEM:CAT? can be used to get the available memories. Memory name between double quotes.</p>
<p>Parameters Parameter Format Example Query Format Returned Data Format Query Example</p>	<p>&lt;cr&gt; MEAS:LOG:MEM "USBA" <b>MEASure:LOGger:MEMory?</b> &lt;cr&gt; MEAS:LOG:MEM? USBA</p>
<p>Query Format Description Returned Data Format Query Example</p>	<p><b>MEASure:LOGger:MEMory:CATalog?</b> Returns the catalog of available memory names. &lt;cr&gt; MEAS:LOG:MEM:CAT? RAM, USBA</p>
<p>Command Syntax Description</p>	<p><b>MEASure:LOGger:RATE</b> Sets the frequency at which the logging process will take measurements.</p>
<p>Parameters Parameter Format Example Query Format Returned Data Format Query Example</p>	<p>Frequency in Hz. Range is 1 Hz through 10 Hz. &lt;nr1&gt; MEAS:LOG:RATE 5 <b>MEASure:LOGger:RATE?</b> &lt;nr1&gt; MEAS:LOG:RATE? 5</p>
<p>Command Syntax Description</p>	<p><b>MEASure:LOGger:TIMEstamp &lt;cr&gt;</b> Sets the time stamp format that will be attached to every measurement record in the measurement log file.</p>
<p>Parameters Parameter Format Example Query Format Returned Data Format Query Example</p>	<p>&lt; DATE   0   TIME   1   ALL   2 &gt; &lt;cr&gt; MEAS:LOG:TIME ALL <b>MEASure:LOGger:TIMEstamp?</b> &lt;nr1&gt; MEAS:LOG:TIME? 2</p>

### 8.4.8 Waveform Capture Commands

Waveform capture commands may be used to retrieve time domain voltage and current waveform captures similar to those of a digital oscilloscope.

Query Format	<b>FETCH:WAVEform:VOLTage#?</b>
Description	Returns time domain data for voltage on selected phase #. # = 1, 2 or 3. Returns a string of <nr2> type numbers, comma delimited. Only a single waveform may be queried in a command. Note: In UPC Compatibility mode, a total of 512 data points are returned. In LSX mode, 1024 data points are returned.
Returned Data Format	<nr2>, <nr2>, <nr2>,....., <nr2>
Query Example	FETCH:WAVE:VOLT1? 0.000, 0.0001, 0.0003....., 0.000
Query Format	<b>FETCH[:WAVEform]:VLL#?</b>
Description	Returns time domain data for voltage on selected Line to Line voltage #. # = 1, 2 or 3. Returns a string of <nr2> type numbers, comma delimited. Only a single waveform may be queried in a command. Note: In UPC Compatibility mode, a total of 512 data points are returned. In LSX mode, 1024 data points are returned.
Returned Data Format	<nr2>, <nr2>, <nr2>,....., <nr2>
Query Example	FETCH:WAVE:VLL1? 0.000, 0.0001, 0.0003....., 0.000
Query Format	<b>FETCH:WAVEform:CURREnt#?</b>
Description	Returns time domain data for current on selected phase #. # = 1, 2 or 3. Returns a string of <nr2> type numbers, comma delimited. Only a single waveform may be queried in a command. Note: In UPC Compatibility mode, a total of 512 data points are returned. In LSX mode, 1024 data points are returned.
Returned Data Format	<nr2>, <nr2>, <nr2>,....., <nr2>
Query Example	FETCH:WAVE:CURREnt? 0.000, 0.0001, 0.0003....., 0.000
Query Format	<b>FETCH:WAVEform:INFO?</b>
Description	Returns the output measurement frequency, date and time of capture for the last waveform data fetched.
Returned Data Format	<nr2>, <dd/mm/yyyy>, <hh:mm:ss>
Query Example	FETCH:WAVE:INFO? 400.000, "05/21/2018", "14:34:20"



---

Query Format	<b>FETCH:WAVEform:PERIOD?</b>
Description	Returns the number of periods captured. Minimum period is 1, max no. of periods is 4.
Returned Data Format	<nr2>, <dd/mm/yyyy>, <hh:mm:ss>
Query Example	FETCH:WAVE:PERIOD? 400.000, "05/21/2018", "14:34:20"

### 8.4.9 Harmonic Measurements Commands

Harmonic Measurements commands may be used to retrieve harmonic analysis data for voltage and current. These measurements are returned using the SPECTrum commands.

Query Format	<b>MEASure:SPECTrum:VOLTage#[:MAGnitude]?</b>
Description	Returns harmonics spectrum for voltage on selected phase #. # = 1, 2 or 3. Returns a data set of 51, <nr2> type numbers, comma delimited. The 1 <sup>st</sup> element is the magnitude of the fundamental, for reference. The 2 <sup>nd</sup> element is the 2 <sup>nd</sup> harmonic, etc. Values represent % of fundamental (relative). Only a single spectrum may be queried in a command.
Returned Data Format	<nr2>, <nr2>, <nr2>,....., <nr2>
Query Example	MEAS:SPECT:VOLT1? 100.000, 0.001, 0.3....., 0.000
Query Format	<b>MEASure:SPECTrum:VLL#[:MAGnitude]?</b>
Description	Returns harmonics spectrum for three phase Line to Line voltage on selected phase #. # = 1, 2 or 3 (1 = Vab, 2 = Vbc, 3 = Vac). Returns a VLL data set of 51, <nr2> type numbers, comma delimited. The 1 <sup>st</sup> element is the magnitude of the fundamental, for reference. The 2 <sup>nd</sup> element is the 2 <sup>nd</sup> harmonic, etc. Values represent % of fundamental (relative). Only a single spectrum may be queried in a command.
Returned Data Format	<nr2>, <nr2>, <nr2>,....., <nr2>
Query Example	MEAS:SPECT:VLL1? 207.000, 0.001, 0.3....., 0.000
Query Format	<b>MEASure:SPECTrum:VLL#:ABSolute?</b>
Description	Returns absolute harmonics spectrum for three phase Line to Line voltage on selected phase #. # = 1, 2 or 3 (1 = Vab, 2 = Vbc, 3 = Vac). Returns a VLL data set of 51, <nr2> type numbers, comma delimited. The 1 <sup>st</sup> element is the magnitude of the fundamental, for reference. The 2 <sup>nd</sup> element is the 2 <sup>nd</sup> harmonic, etc. Values represent % of fundamental (relative). Only a single spectrum may be queried in a command.
Returned Data Format	<nr2>, <nr2>, <nr2>,....., <nr2>
Query Example	MEAS:SPECT:VLL1:ABS? 207.000, 0.001, 0.3....., 0.000

Query Format Description	<p><b>MEASure:SPECTrum:CURRent#[:MAGnitude]?</b></p> <p>Returns harmonics spectrum for current on selected phase #. # = 1, 2 or 3. Returns a data set of 51, &lt;nr2&gt; type numbers, comma delimited. The 1<sup>st</sup> element is the magnitude of the fundamental, for reference. The 2<sup>nd</sup> element is the 2<sup>nd</sup> harmonic, etc. Values represent % of fundamental (relative).</p> <p>Only a single spectrum may be queried in a command.</p>
Returned Data Format Query Example	<p>&lt;nr2&gt;, &lt;nr2&gt;, &lt;nr2&gt;,....., &lt;nr2&gt;</p> <p>MEAS:SPECT:CURR1?</p> <p>4.6300, 0.001, 0.23....., 0.000</p>
Command Syntax Description	<p><b>MEASure:SPECTrum:PHASe:REFerence</b></p> <p>This command sets the phase reference for the harmonic analysis measurement function.</p>
Parameters	<p>Available settings are:</p> <ul style="list-style-type: none"> <li>0 None.</li> <li>1 (DEFAULT) All phases measurements are referenced to phase A voltage.</li> <li>2 Voltage and current phases measurements are referenced to the voltage of the same phase (A, B or C)</li> <li>3 Voltage phase measurements are referenced to the voltage of the same phase (A, B or C). Current phase measurements are referenced to the current of the same phase (A, B or C)</li> </ul>
Parameter Format Example	<nr1>
Query Format	MEAS:SPECT:PHAS:REF 2
Returned Data Format	<b>MEASure:SPECTrum:PHASe:REFerence?</b>
Query Example	<p>&lt;nr1&gt;</p> <p>MEAS:SPECT:PHAS:REF?</p> <p>2</p>
Query Format Description	<p><b>MEASure:SPECTrum:PHASe?</b></p> <p>Returns phase angles in degrees for the most recent voltage or current spectrum query. Returns a data set of 51, &lt;nr2&gt; type numbers, comma delimited. The 1<sup>st</sup> element is the phase angle of the fundamental, for reference. The 2<sup>nd</sup> element is the phase angle of the 2<sup>nd</sup> harmonic, etc.</p>
Returned Data Format Query Example	<p>&lt;nr2&gt;, &lt;nr2&gt;, &lt;nr2&gt;,....., &lt;nr2&gt;</p> <p>MEAS:SPECT:PHAS?</p> <p>0.000, 20.000, 30.000....., 0.000</p>

<p>Query Format Description</p>	<p><b>MEASure:SPECTrum:VOLTage#:PHASe?</b> Same as “MEASure:SPECTrum:PHASe?” but selects voltage and phase #. Returns phase angles in degrees for the most recent voltage spectrum query. Returns a data set of 51, &lt;nr2&gt; type numbers, comma delimited. The 1<sup>st</sup> element is the phase angle of the fundamental, for reference. The 2<sup>nd</sup> element is the phase angle of the 2<sup>nd</sup> harmonic, etc.</p>
<p>Returned Data Format Query Example</p>	<p>&lt;nr2&gt;, &lt;nr2&gt;, &lt;nr2&gt;,....., &lt;nr2&gt; MEAS:SPECT:VOLT1:PHAS? 0.000, 20.000, 30.000....., 0.000</p>
<p>Query Format Description</p>	<p><b>MEASure:SPECTrum:VLL#:PHASe?</b> Same as “MEASure:SPECTrum:PHASe?” but selects Line to Line voltage and phase #. Returns phase angles in degrees for the most recent voltage spectrum query. Returns a data set of 51, &lt;nr2&gt; type numbers, comma delimited. The 1<sup>st</sup> element is the phase angle of the fundamental, for reference. The 2<sup>nd</sup> element is the phase angle of the 2<sup>nd</sup> harmonic, etc.</p>
<p>Returned Data Format Query Example</p>	<p>&lt;nr2&gt;, &lt;nr2&gt;, &lt;nr2&gt;,....., &lt;nr2&gt; MEAS:SPECT:VLL1:PHAS? 0.000, 20.000, 30.000....., 0.000</p>
<p>Query Format Description</p>	<p><b>MEASure:SPECTrum:CURREnt#:PHASe?</b> Same as “MEASure:SPECTrum:PHASe?” but selects current and phase #. Returns phase angles in degrees for the most recent current spectrum query. Returns a data set of 51, &lt;nr2&gt; type numbers, comma delimited. The 1<sup>st</sup> element is the phase angle of the fundamental, for reference. The 2<sup>nd</sup> element is the phase angle of the 2<sup>nd</sup> harmonic, etc.</p>
<p>Returned Data Format Query Example</p>	<p>&lt;nr2&gt;, &lt;nr2&gt;, &lt;nr2&gt;,....., &lt;nr2&gt; MEAS:SPECT:CURR:PHAS? 0.000, 20.000, 30.000....., 0.000</p>
<p>Query Format Description</p>	<p><b>MEASure:SPECTrum:THD?</b> Returns Total Harmonic Distortion of the most recent <b>:MEASure:SPECTrum:parameter</b> command</p>
<p>Returned Data Format Query Example</p>	<p>&lt;nr2&gt; MEAS:SPECT:THD? 2.5600</p>
<p>Query Format Description</p>	<p><b>MEASure:SPECTrum:VOLTage#:THD?</b> Same as “MEASure:SPECTrum:THD?” but selects voltage and phase #.Returns Total Harmonic Distortion of the selected phase voltage.</p>
<p>Returned Data Format Query Example</p>	<p>&lt;nr2&gt; MEAS:SPECT:VOLT1:THD? 2.5600</p>

Query Format	<b>MEASure:SPECTrum:VLL#:THD?</b>
Description	Same as “MEASure:SPECTrum:THD?” but selects Line to Line voltage #.Returns Total Harmonic Distortion of the selected Line to Line voltage.
Returned Data Format	<nr2>
Query Example	MEAS:SPECT:VLL1:THD? 2.5600
Query Format	<b>MEASure:SPECTrum:CURREnt#:THD?</b>
Description	Same as “MEAS:SPECTrum:THD?” but selects current and phase #.Returns Total Harmonic Distortion of the selected phase currebt.
Returned Data Format	<nr2>
Query Example	MEAS:SPECT:CURR1:THD? 2.5600
Query Format	<b>MEASure:SPECTrum:EHD?</b>
Description	Returns Even Harmonic Distortion of the most recent <b>:MEASure:SPECTrum:parameter</b> command
Returned Data Format	<nr2>
Query Example	MEAS:SPECT:EHD? 3.5690
Query Format	<b>MEASure:SPECTrum:VOLTage#:EHD?</b>
Description	Same as “MEAS:SPECTrum:EHD?” but selects voltage and phase #.Returns Even Harmonic Distortion of the selected phase voltage.
Returned Data Format	<nr2>
Query Example	MEAS:SPECT:VOLT1:EHD? 10.5891
Query Format	<b>MEASure:SPECTrum:VLL#:EHD?</b>
Description	Same as “MEAS:SPECTrum:EHD?” but selects Line to Line voltage #.Returns Even Harmonic Distortion of the selected Line to Line voltage.
Returned Data Format	<nr2>
Query Example	MEAS:SPECT:VLL1:EHD? 10.5891
Query Format	<b>MEASure:SPECTrum:CURREnt#:EHD?</b>
Description	Same as “MEAS:SPECTrum:EHD?” but selects current and phase #.Returns Even Harmonic Distortion of the selected phase currebt.
Returned Data Format	<nr2>
Query Example	MEAS:SPECT:CURR1:EHD? 22.5948

Query Format	<b>MEASure:SPECTrum:OHD?</b>
Description	Returns Odd Harmonic Distortion of the most recent <b>:MEASure:SPECTrum:parameter</b> command
Returned Data Format	<nr2>
Query Example	MEAS:SPECT:OHD? 3.5690
Query Format	<b>MEASure:SPECTrum:VOLTage#:OHD?</b>
Description	Same as “MEAS:SPECTrum:OHD?” but selects voltage and phase #.Returns Odd Harmonic Distortion of the selected phase voltage.
Returned Data Format	<nr2>
Query Example	MEAS:SPECT:VOLT1:OHD? 10.5891
Query Format	<b>MEASure:SPECTrum:VLL#:OHD?</b>
Description	Same as “MEAS:SPECTrum:OHD?” but selects Line to Line voltage #.Returns Odd Harmonic Distortion of the selected Line to Line voltage.
Returned Data Format	<nr2>
Query Example	MEAS:SPECT:VOLT1:OHD? 10.5891
Query Format	<b>MEASure:SPECTrum:CURREnt#:OHD?</b>
Description	Same as “MEAS:SPECTrum:OHD?” but selects current and phase #.Returns Odd Harmonic Distortion of the selected phase currebt.
Returned Data Format	<nr2>
Query Example	MEAS:SPECT:CURR1:OHD? 22.5948

#### 8.4.10 Measurement Resolution Setting Commands

All SCPI measurement commands return measurement data in a format with a specific resolution, i.e. a certain number of digits after the decimal point. The default resolution (number of positions after the decimal point) for each parameter is chosen based on the dimension (VA or KVA) and measurement accuracy of that specific parameter.

The user can increase or decrease the number of digits for each measurement parameter if so desired by using the RESolution commands listed in this section<sup>15</sup>.

**Note:** Increasing the resolution of a measurement for any parameter does NOT improve the specified measurement's accuracy specification. As such, digits added for to any measurement may not represent meaningful information.

The generic format for this command is:

**MEASure:MMMnnn:RESolution <RESOLUTION>**

**MEASure:MMMnnn:RESolution?**

Where MMMnnn is the measurement command syntax of the measurement for which the resolution is to be set. The Query command can be used to query a command's active resolution setting.

<RESOLUTION> is a formatted number that specifies the number of digits to include in the query response. For example:

0.1	Only one digit behind the decimal point
0.0001	4 digits behind the decimal point
0.00001	6 digits behind the decimal point

**Example:**

MEASure:POWer:RESolution 0.00001

This changes the number of digits for True Power measurements from the default 4 to 5. Since Power measurements are reported in KW, this is equivalent to changing the measurement resolution from 0.1 W /10mW to 0.01W / 10mW. All these settings are independent of each other so only the specified measurement command's resolution will be changed. To change multiple commands, send this command for each one.

**Note:** Changing the resolution for any measurement command does NOT affect the displayed resolution of measurements in any of the power sources' front panel display screen. This command only affects remote control bus measurement queries.

**Note:** Once a command's resolution has been changed using the MEASure:MMMnnn:RESolution <RESOLUTION> command, the new resolution format is persistent, i.e. it remains in effect between power on/off cycles. To change it back, a new RESolution command must be sent.

---

<sup>15</sup> Requires Firmware Revision 3.2.11 or higher

The following table shows the available RESolution commands.

Measurement Resolution Command	Query Format
MEASure:VOLTage:RESolution <RESOLUTION>	MEASure:VOLTage:RESolution?
MEASure:VLL:RESolution <RESOLUTION>	MEASure:VLL:RESolution?
MEASure:FREQuency:RESolution <RESOLUTION>	MEASure:FREQuency:RESolution?
MEASure:CURRent:RESolution <RESOLUTION>	MEASure:CURRent:RESolution?
MEASure:CURRent:CREST:RESolution <RESOLUTION>	MEASure:CURRent:CREST:RESolution?
MEASure:POWer:RESolution <RESOLUTION>	MEASure:POWer:RESolution?
MEASure:KVA:RESolution <RESOLUTION>	MEASure:KVA:RESolution?
MEASure:PF:RESolution <RESOLUTION>	MEASure:PF:RESolution?
MEASure:TEMPerature:RESolution <RESOLUTION>	MEASure:TEMPerature:RESolution?
MEASure:SPECTrum:VOLTage:RESolution <RESOLUTION>	MEASure:SPECTrum:VOLTage:RESolution?
MEASure:SPECTrum:VLL:RESolution <RESOLUTION>	MEASure:SPECTrum:VLL:RESolution?
MEASure:SPECTrum:CURRent:RESolution <RESOLUTION>	MEASure:SPECTrum:CURRent:RESolution?
MEASure:SPECTrum:PHASe:RESolution <RESOLUTION>	MEASure:SPECTrum:PHASe:RESolution?
MEASure:SPECTrum:THD:RESolution <RESOLUTION>	MEASure:SPECTrum:THD:RESolution?
MEASure:SPECTrum:OHD:RESolution <RESOLUTION>	MEASure:SPECTrum:OHD:RESolution?
MEASure:SPECTrum:EHD:RESolution <RESOLUTION>	MEASure:SPECTrum:EHD:RESolution?
MEASure:KWHour:RESolution <RESOLUTION>	MEASure:KWHour:RESolution?
FETCH[:WAVEform]:VOLTage:RESolution <RESOLUTION>	FETCH[:WAVEform]:VOLTage:RESolution?
FETCH[:WAVEform]:VLL:RESolution <RESOLUTION>	FETCH[:WAVEform]:VLL:RESolution?
FETCH[:WAVEform]:CURRent:RESolution <RESOLUTION>	FETCH[:WAVEform]:CURRent:RESolution?



## 8.5 Output Control Commands

The output command subsystem is used to control the output state of the power source.

Command Syntax Description	<b>OUTPut[:STATE]</b> Enables or Disables power output. When enabled, all output relays are closed. When disabled, all output relays are open. The time it takes for the output to turn on is determined by the status of the OUTP:FAST setting. If the power source is in sleep mode (all power stages are off), it will take about 2.2 seconds before the output relays are closed. This is required to let all stages settle. If the power source is in standby mode, it will only take 200 msec to close the output relay as only the second (inverter) stage needs to settle. Note: Sending the OUTP OFF command will only cause the second stage to be turned off. The primary stages remain on and thus the AC source will be in standby mode. If OUTP:FAST = 0, the primary stages will turn off after 5 minutes of non-use and the AC source will enter sleep mode. Refer to section <b>Error! Reference source not found.</b> , “ <b>Error! Reference source not found.</b> ” for more details.
Parameters Parameter Format Example Query Format Returned Data Format Query Example	< 0   OFF   1   ON > <b> OUTP ON <b>OUTPut[:STATe]?</b> <b> OUTP? 1
Command Syntax Description	<b>OUTPut[:STATe]:ALL</b> This command enables or disables the output and is similar to the OUTPut[:STATe] command but always turns off all power stages, regardless of the energy savings mode set with the OUTP:FAST command. Thus, the OUTP:ALL OFF command will turn off all power stages and put the AC source in sleep mode. <b>Note:</b> The OUTP:ALL ON command has the same effect as the OUTP ON command.
Parameters Parameter Format Example	< 0   OFF   1   ON > <b> OUTP:ALL OFF

Command Syntax Description  OUTPut:AUTO = ON  OUTPut:AUTO = OFF  Parameters Parameter Format Example Query Format Returned Data Format Query Example	<b>OUTPut[:STATe]:AUTO</b> This commands determines the state of the OUTPUT when the power source is turned on (powered on). The output will be enabled at power on IF it was ON at the time the front panel circuit breaker of the unit was switched off. Thus, the output state will revert to the last state before power-off. This command in combination with the “[SOURce:]INITial” command allows the unattended resumption of a test station after a power failure. <b>Note:</b> This condition is potentially hazardous and should be used with caution. The output will always come up in the OFF state. < 0   OFF   1   ON > <b> OUTP:AUTO ON <b>OUTPut[:STATe]:AUTO?</b> <b> OUTP:AUTO? 1
Command Syntax Description  Parameters Parameter Format Example  Query Format Returned Data Format Query Example	<b>OUTPut:DISABLEPHase</b> This command sets the disable phase angle. This is the phase angle on phase A at which the power source output will be disabled. Available range is 0 ~ 360. Also allows a negative number that indicates a RANDOM phase angle/ <b>Note:</b> Available in units with Firmware revision 1.6.6 or higher. Refer also to the OUTPut:ZEROprogram command. 0.0 ~ 360.0 or negative number <nr2> OUTPDISABLEPH 90.0 OUTPDISABLEPH -1 <b>OUTPut:DISABLEPHase?</b> <nr2> OUTP:DISABLEPH? 90.000

Query Syntax	<b>OUTPut:DISABLEPHase:MINimum</b> <b>OUTPut:DISABLEPHase:MAXimum</b> <b>OUTPut:DISABLEPHase:DEFault</b>
Description	These query commands return minimum, maximum and default Output Disable Phase values respectively. Available range is -0.01 (Random) through 360.0. <b>Note:</b> Available in units with Firmware revision 1.6.6 or higher.
Returned Data Format	<nr2>
Query Example	OUTP:DISABLEPH:MIN? -0.010 OUTP:DISABLEPH:MAX? 360.000 OUTP:DISABLEPH:DEF? 0.000
Command Syntax	<b>OUTPut:IDLEondisable</b>
Description	This command simulates the behavior of the legacy ASX/AMX UPC controller output relay front panel toggle switch. When set to 0 (or OFF), it allows voltage measurements of the output converters to be made while the output relay is <b>open</b> (output off state). When set to 1 (or ON, default setting), the source will measure zero output unless the output is enabled (Output on state).
Parameters	< 0   OFF   1   ON >
Parameter Format	<b>
Example	OUTPut:IDLEondisable 0
Query Format	<b>OUTPut:IDLEondisable?</b>
Returned Data Format	<nr1>
Query Example	OUTPut:IDLEondisable? 0
Command Syntax	<b>OUTPut:ZEROprogram:RAMP &lt;nr1&gt;</b>
Description	This command sets the voltage ramp down to zero time before opening the output relay when the OUTP OFF   0 command is sent. See Figure for reference. Default value is 0 msec. <a href="#">This command is intended for uses with XFMR units but configurable for both couplings. XFMR and direct parameters are independent. For direct coupling delay is 100ms and ramp 0ms by default but can be changed to any value. The ramp allows the voltage to reduce slowly, useful for reducing the magnetization of the transformer so at the next turn on, there is no excessive peak current due to remaining magnetization.</a>
Parameters	Time in msec.
Parameter Format	<nr1>
Example	OUTP:ZERO:RAMP? 50
Query Format	<b>OUTPut:ZEROprogram:RAMP?</b>
Returned Data Format	<nr1>
Query Example	OUTP:ZERO:RAMP? 50

Command Syntax	<b>OUTPut:ZEROprogram:DWELL &lt;nr1&gt;</b>
Description	This command sets the voltage dwell time before opening the output relay when the OUTP OFF   0 command is sent. See Figure for reference. Default value is 100 msec. <b>Note:</b> Available in units with Firmware revision 2.2.12 or higher.
Parameters	Time in msec.
Parameter Format	<nr1>
Example	OUTP:ZERO:DWELL? 20
Query Format	<b>OUTPut:ZEROprogram:DWELL?</b>
Returned Data Format	<nr1>
Query Example	OUTP:ZERO:DWELL? 20

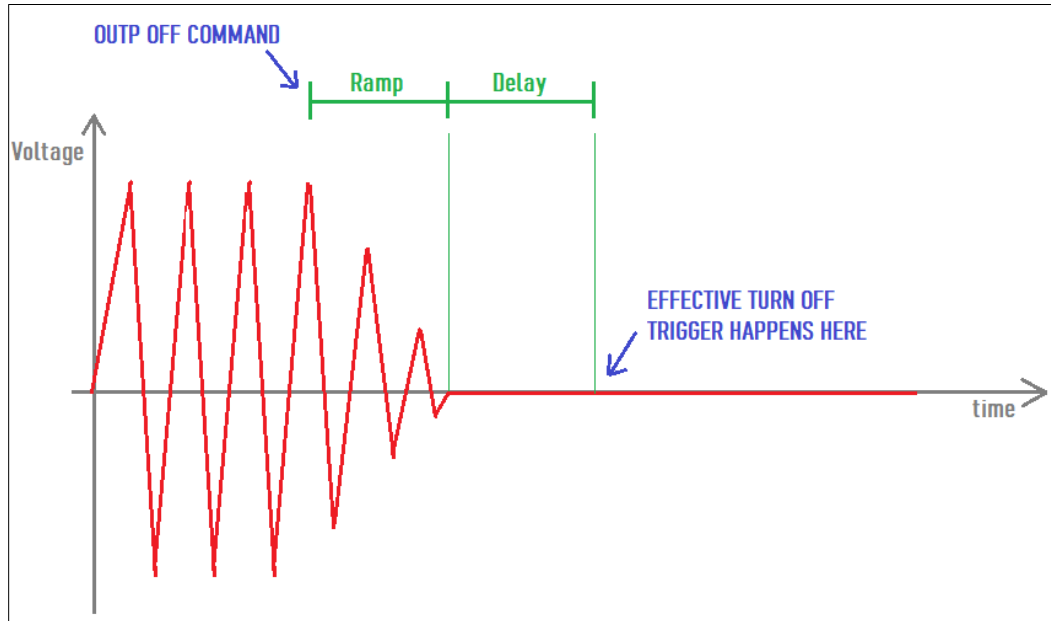


Figure 8-1: OUTP:ZERO Command Ramp and Dwell settings

## 8.6 Program Commands

Program commands allow management and programming of stored program segments for steady state. These commands are grouped by the following subsystems.

- Program Control Commands
- Execution Commands
- Transient Segment Commands
- Memory Management Commands

The Program commands are similar to those found on the Pacific Power UPC controllers used for other PPS AC power source models.

### 8.6.1 Program Control Commands

The following commands allow recall of stored programs and transient segments. Programs are selected and recalled using their memory location reference ranging from 1 through 99. Program location zero (0) is reserved for the Manual Mode setup. Optionally, a memory source may be specified. If none is provided, INTERNAL memory is used as a default.

Command Syntax	<b>PROG</b> ram:NAME [<nr1>,<cr>] [<cr>,<cr>] <cr>
Description	This command selects program <nr1> for execution deletion or copying.
Parameters	Option: PROGRAM, NUMBER [,<cr>} or [,<nr1>] - 0 through 99 Option: MEMORY [,<cr>} – Available are: INTERNAL   RAM   USB Parameter list define string <cr>,<cr>,<cr>,<cr>,<cr>
Parameter Format	<nr1> [,<cr>]
Example	PROG:NAME 4, USB
Query Format	<b>PROG</b> ram:NAME?
Description	The query format of this command returns the value of last program selected. Returned value range is 0 through 99.
Returned Data Format	<nr1>
Query Example	PROG:NAME? 4

Command Syntax Description	<p><b>PROG</b>[:SELEcted]:DEFine [&lt;nr1&gt;] [&lt;cr&gt;] &lt;cr&gt;</p> <p>This command programs all values stored in the selected program number. Both steady-state and transient segment parameter names and values may be sent. Program parameters are defined in the following sections.</p> <p><b>NOTE:</b> Only commas may separate the values, NO Carriage Returns or Line Feeds may separate the values within a single command message.</p>
Parameters	<p>Option: PROGRAM, NUMBER [,&lt;cr&gt;} or [,&lt;nr1&gt;]</p> <p>Option: MEMORY [,&lt;cr&gt;] – Available are: INTERNAL   RAM   USB</p> <p>Parameter list define string &lt;cr&gt;,&lt;cr&gt;,&lt;cr&gt;,&lt;cr&gt;</p> <p><b>Note 1:</b> All the tags must be <b>uppercase</b>.</p> <p><b>Note 2:</b>The order on the transient/step tags must be sequential.</p>
Steady State list Tags	<p>FORM,&lt;n&gt;, COUPLing,&lt;s&gt;, XFMRRATIO,&lt;n.nn&gt;, FREQUency,&lt;n&gt;, VOLTage,&lt;n&gt;, VOLTage1,&lt;n&gt;, VOLTage2,&lt;n&gt;, VOLTage3,&lt;n&gt;, CURRent:LIMit,&lt;n&gt;, CURRent:PROTect:LEVel,&lt;n&gt; CURRent:PROTect:TOUT,&lt;n&gt; PHASe2,&lt;n&gt;, PHASe3,&lt;n&gt;, WAVEFORM,&lt;n&gt;, WAVEFORM1,&lt;n&gt;, WAVEFORM2,&lt;n&gt;, WAVEFORM3,&lt;n&gt;, EVENTS,&lt;n&gt;, AUTORMS,&lt;n&gt; NSEGS, &lt;n&gt;</p> <p>see Convention #13.</p> <p>see Convention #13.</p>
<b>Optional Transient SEGment list Tags</b>	<p>SEGment,&lt;n&gt;, FSEG,&lt;n&gt;, VSEG,&lt;n&gt;, VSEG1,&lt;n&gt;, VSEG2,&lt;n&gt;, VSEG3,&lt;n&gt;, PSEG1, &lt;n&gt; PSEG2, &lt;n&gt; PSEG3, &lt;n&gt; WFSEG,&lt;n&gt; WFSEG1,&lt;n&gt;, WFSEG2,&lt;n&gt;, WFSEG3,&lt;n&gt;, TSEG,&lt;n&gt;, LAST</p> <p>Multiple segments per Program Message may be sent, see Convention 17.</p> <p>AC Voltage, see Convention #13.</p> <p>Cmd available for FW 3.6.x or higher only</p> <p>see Convention #13.</p> <p>Sent only if this is the LAST segment.</p>



**Segment Example Program Strings:**

**TRANSIENT EXECUTION**

RUN STOP STEP RESTART

STATE: STOPPED

PROGRESS: 0%

REPEAT TIMES COUNTER: 0

CONFIGURATION: SETTINGS

RUN FROM SEGMENT #: 1

RUN TO SEGMENT #: 2

REPEAT TIMES: Infinite

APPLY CANCEL

**TRANSIENT TABLE**

MODE: STEP SEGMENT EDIT MODE: CYCLE BASED TIME BASED

#	TIME [ms]	FREQ [Hz]	V <sub>AC</sub> [VRMS] A/B/C	V <sub>DC</sub> [V] A/B/C	Waveform [#] A/B/C	Phase [Deg] A/B/C
1	100.0	60.00	0.00	0.00	1	0.00/120.00/240.00
2	100.0	60.00	0.00	0.00	1	0.00/120.00/240.00

APPLY CANCEL + ADD ROW - DELETE ROW CLEAR

PROGram:DEFine

```
FORM,3,COUPL,DIRECT,VOLT:MODE,2,CONFIG,0,RANG,0,FREQ,60.000,VOLT1,0.000,VOLT2,0.000,VOLT3,0.000,VOLT:ALC:STAT,1,CURR:OV,0,CURR:LIM1,130.000,CURR:LIM2,130.000,CURR:LIM3,130.000,IPROT:STAT,0,CURR:PROT:LEV,130.000,IPEAK:LIM,360.000,PHAS1,0.000,PHAS2,120.000,PHAS3,240.000,WAVEFORM1,1,WAVEFORM2,1,WAVEFORM3,1,POW:LIM1,17.2500,POW:LIM2,17.2500,POW:LIM3,17.2500,KVA:LIM1,17.2500,KVA:LIM2,17.2500,KVA:LIM3,17.2500,PPROT:STAT,0,POW:PROT:LEV,17.2500,KVA:PROT:LEV,17.2500,PROT:TDELAY,5,FREQ:SLEW,5.000,VOLT:SLEW,10.000,UPDATEPH,0.000,RAMP,0.0002,VPEAK:MARG,100.000,EVENTS,0,AUTORMS,1,SEG,1,FSEG,60.00,VSEG1,0.00,VSEG2,0.00,VSEG3,0.00,VDCSEG1,0.00,VDCSEG2,0.00,VDCSEG3,0.00,PSEG2,120.00,PSEG3,240.00,WFSEG1,1,WFSEG2,1,WFSEG3,1,TSEG,0.1000,SEG,2,FSEG,60.00,VSEG1,0.00,VSEG2,0.00,VSEG3,0.00,PSEG2,120.00,PSEG3,240.00,WFSEG1,1,WFSEG2,1,WFSEG3,1,TSEG,0.1000,LAST
(Note I removed NSEGS,2 PSEG1,0.00)
```

PROGram:DEFine:ALL?

```
FORM,3,COUPL,DIRECT,VOLT:MODE,2,CONFIG,0,RANG,0,FREQ,60.000,VOLT1,0.000,VOLT2,0.000,VOLT3,0.000,VOLT:ALC:STAT,1,CURR:OV,0,CURR:LIM1,130.000,CURR:LIM2,130.000,CURR:LIM3,130.000,IPROT:STAT,0,CURR:PROT:LEV,130.000,IPEAK:LIM,360.000,PHAS1,0.000,PHAS2,120.000,PHAS3,240.000,WAVEFORM1,1,WAVEFORM2,1,WAVEFORM3,1,POW:LIM1,17.2500,POW:LIM2,17.2500,POW:LIM3,17.2500,KVA:LIM1,17.2500,KVA:LIM2,17.2500,KVA:LIM3,17.2500,PPROT:STAT,0,POW:PROT:LEV,17.2500,KVA:PROT:LEV,17.2500,PROT:TDELAY,5,FREQ:SLEW,5.000,VOLT:SLEW,10.000,UPDATEPH,0.000,RAMP,0.0002,VPEAK:MARG,100.000,EVENTS,0,AUTORMS,1,NSEGS,2,SEG,1,FSEG,60.00,VSEG1,0.00,VSEG2,0.00,VSEG3,0.00,PSEG1,0.00,PSEG2,120.00,PSEG3,240.00,WFSEG1,1,WFSEG2,1,WFSEG3,1,TSEG,0.1000,SEG,2,FSEG,60.00,VSEG1,0.00,VSEG2,0.00,VSEG3,0.00,PSEG1,0.00,PSEG2,120.00,PSEG3,240.00,WFSEG1,1,WFSEG2,1,WFSEG3,1,TSEG,0.1000,LAST
```



**Step** Example Program Strings:

The screenshot displays the 'TRANSIENT EXECUTION' and 'TRANSIENT TABLE' sections of the remote control programming interface.

**TRANSIENT EXECUTION**

- Buttons: RUN, STOP, STEP, RESTART
- STATE: STOPPED
- PROGRESS: 0%
- REPEAT TIMES COUNTER: 0
- CONFIGURATION: SETTINGS
- PARAMETERS:
  - RUN FROM STEP #: 1
  - RUN TO STEP #: 1
  - REPEAT TIMES: Infinite
- Buttons: APPLY, CANCEL

**TRANSIENT TABLE**

- MODE: STEP, SEGMENT
- EDIT MODE: CYCLE BASED, TIME BASED
- Table with columns: #, RAMP [ms], DWELL [ms], FREQ [Hz], V<sub>AC</sub> [V<sub>RMS</sub>] A/B/C, V<sub>DC</sub> [V] A/B/C, Waveform [#] A/B/C, Phase [Deg] A/B/C
- Table Row 1: > 1, 100.0, 100.0, 60.00, 0.00, 0.00, 1, 0.00/120.00/240.00
- Buttons: APPLY, CANCEL, ADD ROW, DELETE ROW, CLEAR

PROGram:DEFine

```
FORM,3,COUPL,DIRECT,VOLT:MODE,2,CONFIG,0,RANG,0,FREQ,60.000,VOLT1,0.000,VOLT2,0.000,VOLT3,0.000,VOLT:ALC:STAT,1,CURR:OV,0,CURR:LIM1,130.000,CURR:LIM2,130.000,CURR:LIM3,130.000,IIPROT:STAT,0,CURR:PROT:LEV,130.000,IPEAK:LIM,360.000,PHAS1,0.000,PHAS2,120.000,PHAS3,240.000,WAVEFORM1,1,WAVEFORM2,1,WAVEFORM3,1,VOLT:DC1,0.000,VOLT:DC2,0.000,VOLT:DC3,0.000,POW:LIM1,17.2500,POW:LIM2,17.2500,POW:LIM3,17.2500,KVA:LIM1,17.2500,KVA:LIM2,17.2500,KVA:LIM3,17.2500,PPROT:STAT,0,POW:PROT:LEV,17.2500,KVA:PROT:LEV,17.2500,PROT:TDELAY,5,FREQ:SLEW,5.000,VOLT:SLEW,10.000,VOLT:DC:SLEW,10.000,UPDATEPH,0.000,RAMP,0.0002,VPEAK:MARG,100.000,EVENTS,0,AUTORMS,1,STEP,1,FSTEP,60.00,VSTEP1,0.00,VSTEP2,0.00,VSTEP3,0.00,PSTEP2,120.00,PSTEP3,240.00,WFSTEP1,1,WFSTEP2,1,WFSTEP3,1,RTSTEP,0.1000,DTSTEP,0.1000,LAST
```

Note: NSTEPS,1, PSTEP1,0.00 not included in program command.

PROGram:DEFine:ALL?

```
FORM,3,COUPL,DIRECT,VOLT:MODE,2,CONFIG,0,RANG,0,FREQ,60.000,VOLT1,0.000,VOLT2,0.000,VOLT3,0.000,VOLT:ALC:STAT,1,CURR:OV,0,CURR:LIM1,130.000,CURR:LIM2,130.000,CURR:LIM3,130.000,IIPROT:STAT,0,CURR:PROT:LEV,130.000,IPEAK:LIM,360.000,PHAS1,0.000,PHAS2,120.000,PHAS3,240.000,WAVEFORM1,1,WAVEFORM2,1,WAVEFORM3,1,VOLT:DC1,0.000,VOLT:DC2,0.000,VOLT:DC3,0.000,POW:LIM1,17.2500,POW:LIM2,17.2500,POW:LIM3,17.2500,KVA:LIM1,17.2500,KVA:LIM2,17.2500,KVA:LIM3,17.2500,PPROT:STAT,0,POW:PROT:LEV,17.2500,KVA:PROT:LEV,17.2500,PROT:TDELAY,5,FREQ:SLEW,5.000,VOLT:SLEW,10.000,VOLT:DC:SLEW,10.000,UPDATEPH,0.000,RAMP,0.0002,VPEAK:MARG,100.000,EVENTS,0,AUTORMS,1,NSTEPS,1,STEP,1,FSTEP,60.00,VSTEP1,0.00,VSTEP2,0.00,VSTEP3,0.00,PSTEP1,0.00,PSTEP2,120.00,PSTEP3,240.00,WFSTEP1,1,WFSTEP2,1,WFSTEP3,1,RTSTEP,0.1000,DTSTEP,0.1000,LAST
```

### 8.6.1.1 Steady State Output Parameter List Table

The following table details the available parameters for the steady state program definitions.

Parameter	Description
<b>FORM,&lt;n&gt;</b>	sets Output Power Form of selected program n = <1>Single $\Phi$ , <2>Split $\Phi$ , or <3>Three $\Phi$
<b>COUPLing,&lt;s&gt;</b>	sets Output coupling of selected program s = <DIRECT> <0> or <XFMR> <1>
<b>XFMRRATIO,&lt;n.nn&gt;</b>	sets Output XFMR ratio (n.nn:1) of selected program n.nn = <0.0100> to <5.1111>
<b>FREQuency,&lt;n&gt;</b>	sets Output Frequency of selected program n = <:SOUR:FREQ:LIM:MIN> to <:SOUR:FREQ:LIM:MAX> Hz
<b>VOLTage,&lt;n&gt;</b>	sets Output VOLTAGE $\Phi$ A,B,C of selected program n = <0> to <300 x XFMRRATIO> Volts
<b>VOLTage1,&lt;n&gt;</b>	sets Output VOLTAGE $\Phi$ A of selected program n = <0> to <300 x XFMRRATIO> Volts
<b>VOLTage2,&lt;n&gt;</b>	sets Output VOLTAGE $\Phi$ B of selected program n = <0> to <300 x XFMRRATIO> Volts
<b>VOLTage3,&lt;n&gt;</b>	sets Output VOLTAGE $\Phi$ C of selected program n = <0> to <300 x XFMRRATIO> Volts
<b>CURRent:LIMit,&lt;n&gt;</b>	sets Output Current Limit of selected program n = <0> to <AMPS meter range> Amps
<b>CURRent:PROTect:LEVel,&lt;n&gt;</b>	sets Output Current level that triggers Current Protect mode n = <0> to <AMPS meter range> Amps
<b>CURRent:PROTect:TOUT,&lt;n&gt;</b>	sets time that the Output Current must exceed the Current Protect level before Current Protect disables the power source output. n = <1> to <65535>, 1 = 100mSec.
<b>PHASe2,120</b>	sets Output Phase Angle B of selected program n = 120 degrees
<b>PHASe3,240</b>	sets Output Phase Angle C of selected program n = 240 degrees
<b>WAVEFORM,1</b>	sets Output Waveform $\Phi$ A, $\Phi$ B, $\Phi$ C of selected program n = 1
<b>WAVEFORM1,1</b>	sets Output Waveform $\Phi$ A of selected program n = 1
<b>WAVEFORM2,1</b>	sets Output Waveform $\Phi$ B of selected program n = 1
<b>WAVEFORM3,1</b>	sets Output Waveform $\Phi$ C of selected program n = 1
<b>AUTORMS,&lt;n&gt;</b>	program Transient Waveform Auto RMS mode (4.5.2) n = 0, use program steady-state waveform RMS factor n = 1, calculate RMS factor based on transient waveform

<p>Command Syntax Description</p>	<p><b>PROG:EXECuted:DEFine &lt;cr&gt;</b> This command programs all values stored in the selected program number. Both steady-state and transient segment parameter names and values may be sent. Program parameters are defined in the following sections. <b>NOTE:</b> Only commas may separate the values, NO Carriage Returns or Line Feeds may separate the values within a single command message.</p>
<p>Parameters Parameter Format Example Query Format Returned Data Format Query Example</p>	<p>Refer to PROG:SElected:DEFine command &lt;cr&gt;,&lt;cr&gt;,&lt;cr&gt;,&lt;cr&gt;,&lt;cr&gt; <b>PROG:EXECuted:DEFine?</b> &lt;cr&gt;,&lt;cr&gt;,&lt;cr&gt;,&lt;cr&gt;,&lt;cr&gt; PROG:EXEC:DEF? -&gt; parameter list</p>
<p>Query Format Description Parameters Query Example</p>	<p><b>PROG[:SElected]:DEFine:ALL?</b> This query returns the parameter list for the selected program number or name. Option: PROGRAM, NUMBER [,&lt;cr&gt;} or [,&lt;nr1&gt;] Option: MEMORY [,&lt;cr&gt;}– Available are: INTERNAL   RAM   USB Parameter list define string &lt;cr&gt;,&lt;cr&gt;,&lt;cr&gt;,&lt;cr&gt; PROG:DEF:ALL? -&gt; parameter list</p>
<p>Query Format Description Parameters Query Example</p>	<p><b>PROG:EXECuted:DEFine:ALL?</b> This query returns the parameter list for the executing program number or name. Option: PROGRAM, NUMBER [,&lt;cr&gt;} or [,&lt;nr1&gt;] Option: MEMORY [,&lt;cr&gt;] Parameter list define string &lt;cr&gt;,&lt;cr&gt;,&lt;cr&gt;,&lt;cr&gt; PROG:EXEC:DEF:ALL? 3 -&gt; parameter list</p>
<p>Command Syntax Description Parameters Parameter Format Example Query Format Returned Data Format Query Example</p>	<p><b>PROG[:SElected]:INfOrmation &lt;cr&gt; [,&lt;nr1&gt;] [,&lt;cr&gt;]</b> This command assigns program information data to the selected program. Information string &lt;cr&gt; Option: PROGRAM NUMBER [,&lt;nr1&gt;] Option: MEMORY [,&lt;cr&gt;}– Available are: INTERNAL   RAM   USB &lt;cr&gt; [,&lt;nr1&gt;] [,&lt;cr&gt;] PROG:INfO 3, INTERNAL, SAMPLE TEST <b>PROG[:SElected]:INfOrmation? [&lt;nr1&gt;] [,&lt;cr&gt;]</b> &lt;cr&gt; PROG:INfO? 2, USB -&gt; Program info string</p>

**Command Syntax** **PROGRAM:EXECuted:INfOrMation <cr> [,<nr1>] [,<cr>]**  
**Description** This command assigns program information data to the executing program.  
**Parameters** Information string <cr>  
Option: PROGRAM NUMBER [,<nr1>]  
Option: MEMORY [,<cr>]– Available are: INTERNAL | RAM | USB  
**Parameter Format** <cr> [,<nr1>] [,<cr>]  
**Example** PROG:EXEC:INFO 3, INTERNAL, SAMPLE TEST  
**Query Format** **PROGRAM:EXECuted:INfOrMation? [,<nr1>] [,<cr>]**  
**Returned Data Format** <cr>  
**Query Example** PROG:EXEC:INFO? 2, USB  
-> Program info string

**Command Syntax** **PROGRAM[:SElected]:ALIAS <cr> [,<nr1>] [,<cr>]**  
**Description** This command assigns a user provided alias string name to the selected program. Program number and memory type are optional parameters.  
**Parameters** Alias String <cr>  
Option: PROGRAM NUMBER [,<nr1>]  
Option: MEMORY [,<cr>]– Available are: INTERNAL | RAM | USB  
**Parameter Format** <cr> [,<nr1>] [,<cr>]  
**Example** PROG:ALIAS TEST1  
**Query Format** **PROGRAM[:SElected]:ALIAS? [,<nr1>] [,<cr>]**  
**Returned Data Format** <cr>  
**Query Example** PROG:ALIAS?  
TEST1

**Command Syntax** **PROGRAM:EXECuted:ALIAS <cr> [,<nr1>] [,<cr>]**  
**Description** This command assigns a user provided alias string name to the executing program. Program number and memory type are optional parameters.  
**Parameters** Alias String <cr>  
Option: PROGRAM NUMBER [,<nr1>]  
Option: MEMORY [,<cr>]– Available are: INTERNAL | RAM | USB  
**Parameter Format** <cr> [,<nr1>] [,<cr>]  
**Example** PROG:EXEC:ALIAS TEST2  
**Query Format** **PROGRAM:EXECuted:ALIAS? [,<nr1>] [,<cr>]**  
**Returned Data Format** <cr>  
**Query Example** PROG:EXEC:ALIAS?  
TEST2

<p>Query Format Description</p>	<p><b>PROGram[:SElected]:SST? [,&lt;nr1&gt;] [,&lt;cr&gt;]</b> This command returns the <b>Steady State Table</b> settings of the selected program only. The transient table data is not returned.</p>
<p>Parameters</p>	<p>Option: PROGRAM NUMBER [,&lt;nr1&gt;] Option: MEMORY [,&lt;cr&gt;]– Available are: INTERNAL   RAM   USB</p>
<p>Returned Data Format Query Example</p>	<p>&lt;cr&gt; PROG:SST? 2, USB -&gt; steady state table program data</p>
<p>Query Format Description</p>	<p><b>PROGram:EXECuted:SST? [,&lt;nr1&gt;] [,&lt;cr&gt;]</b> This command returns the <b>Steady State Table</b> settings of the executing program only. The transient table data is not returned.</p>
<p>Parameters</p>	<p>Option: PROGRAM NUMBER [,&lt;nr1&gt;] Option: MEMORY [,&lt;cr&gt;]– Available are: INTERNAL   RAM   USB</p>
<p>Returned Data Format Query Example</p>	<p>&lt;cr&gt; PROG:EXEC:SST? -&gt; steady state table program data</p>
<p>Query Format Description</p>	<p><b>PROGram[:SElected]:TT? [,&lt;nr1&gt;] [,&lt;cr&gt;]</b> This command returns the <b>Transient Table</b> settings of the selected program only. The steady state table data is not returned.</p>
<p>Parameters</p>	<p>Option: STYLE [,&lt;nr1&gt;] 0 = Human readable Style A (default if omitted) 1 = Human readable Style B 2 = Binary Data Format. Can be more useful to search for differences between programs. See <b>PROGram:TT?</b> Command for formats</p>
<p>Returned Data Format Query Example</p>	<p>Option: PROGRAM NUMBER [,&lt;nr1&gt;] Option: MEMORY [,&lt;cr&gt;]– Available are: INTERNAL   RAM   USB &lt;cr&gt; PROG:TT? 1 -&gt; transient table program data</p>

Query Format Description	<p><b>PROGram[:SElected]:CHECK? [,&lt;nr1&gt;] [,&lt;cr&gt;]</b></p> <p>This command performs a check on the selected program steady state tables looking for the following conditions:</p> <ul style="list-style-type: none"> <li>• Hardware Limit violations</li> <li>• User Limit violations</li> <li>• Saturation limits.</li> </ul> <p>If no violations are present, this command returns OK and the program can be executed without generating any errors. If the selected program cannot be run due to one or more issues with its content, one or more errors detailing the issues will be returned. For example, if the upper voltage user limit is set to 100V and the program contains a setting of 300V, a “Cannot load program, Run PROGRAM:CHECK?” error will be generated when attempting to execute this program. When sending the PROGRAM:CHECK? Query, the response will be “VOLT1 AC voltage set point cannot change due to user limit”.</p>
Parameters	Option: PROGRAM NUMBER [,<nr1>]
Returned Data Format	Option: MEMORY [,<cr>]– Available are: INTERNAL   RAM   USB
Query Example	<cr> PROG:CHECK? VOLT1 AC voltage set point cannot change due to user limit
Query Format Description	<p><b>PROGram:EXECuted:CHECK? [,&lt;nr1&gt;] [,&lt;cr&gt;]</b></p> <p>This command serves the same purpose as the PROG:CHECK? Command but applies to a program that is executing.</p>
Parameters	Option: PROGRAM NUMBER [,<nr1>]
Returned Data Format	Option: MEMORY [,<cr>]– Available are: INTERNAL   RAM   USB
Query Example	<cr> PROG:EXEC:CHECK? VOLT1 AC voltage set point cannot change due to user limit
Command Syntax Description	<p><b>PROGram[:SElected]:DElete</b></p> <p>This command deletes the selected program. Attempting to DElete an EXECuting Program will result in an Error.</p>
Parameters	Program number
Parameter Format	<nr1>
Example	PROG:DEL 9

Query Format	<b>PROGram[:SElected]:CHANges? &lt;nr1&gt;, &lt;cr&gt;</b>
Description	This command compares the program that is executing with another program stored in the memory type and location passed as parameters. The results of the comparison is returned as a decimal number ranging from 0 to 15 representing a four bit binary value. This result can be decoded as shown below.
Parameters	Option: PROGRAM NUMBER [,<nr1>] Option: MEMORY [,<cr>]– Available are: INTERNAL   RAM   USB
Returned Data Format	<nr>1
Decoding	Bit 0: If set to 1, there are differences in the steady state table (SST) Bit 1: If set to 1, there are differences in the transient table (TT) Bit 2: If set to 1, there are differences in the ALIAS of the program Bit 3: If set to 1, there are differences in INFOrmation of the program
Query Example	PROG:CHAN? 16
Example	If the query returns zero (0), the program executing is identical to the stored program referenced. If the command returns three (3), the program executing has differences with the referenced program in both the steady state table and the transient table.
Command Syntax	<b>PROGram[:SElected]:COPY &lt;nr1&gt; [,&lt;cr&gt;]</b>
Description	This command copies the selected program as previously specified by the PROG:NAME <nr1> command to destination program number. <b>NOTE:</b> The destination Program specified cannot be currently executing.
Parameters	DESTINATION PROGRAM NUMBER           <nr1> Option: MEMORY [,<cr>]– Available are: INTERNAL   RAM   USB
Parameter Format	<nr1>, [,<cr.>]
Example	PROG:COPY 2, USB
Command Syntax	<b>PROGram:EXECuted:COPY &lt;nr1&gt; [,&lt;cr&gt;]</b>
Description	This command copies the executed program to destination program number.
Parameters	DESTINATION PROGRAM NUMBER           <nr1> Option: MEMORY [,<cr>]– Available are: INTERNAL   RAM   USB
Parameter Format	<nr1>, [,<cr.>]
Example	PROG:EXEC:COPY 2, USB

## 8.6.2 Execution Commands

The following commands may be used to control stored program executions.

Command Syntax	<b>PROG</b> ram[:SElected]:EXECute [<nr1> [,<cr>]
Description	This command executes the selected program (default) or the program number passed as the first parameter.
Parameters	Option: PROGRAM NUMBER [,<nr1>] Option: MEMORY [,<cr>]– Available are: INTERNAL   RAM   USB
Parameter Format	[<nr1> [,<cr>]
Example	PROG:EXEC 2
Query Format	<b>PROG</b> ram[:SElected]:EXECute ?
Description	The query format returns the number of the program that is in effect.
Parameter Format	<nr1>
Example	PROG:EXEC? 23
Command Syntax	<b>PROG</b> ram:EXECute:TRANS [<nr1> [,<cr>]
Description	This command executes the selected program's (default) transient table or the program number passed as the first parameter.
Parameters	Option: PROGRAM NUMBER [,<nr1>] Option: MEMORY [,<cr>]– Available are: INTERNAL   RAM   USB
Parameter Format	[<nr1> [,<cr>]
Example	PROG:EXEC:TRANS 2
Command Syntax	<b>PROG</b> ram:EXECute:TRANS:RESET
Description	This command serves the same purpose as the "PROG:TRANSient STOP" command. See next. This command resets the active transient execution. This command is included to support UPC compatibility mode although it is not documented in the UPC manual. Not recommended for new programs.
Parameters	None
Parameter Format	n/a
Example	PROG:EXEC:TRANS:RESET



### 8.6.3 Transient Segments Commands

The following commands may be used to control stored transient program executions.

Command Syntax	<b>PROG:TRANSient</b>
Description	This command controls transient execution
Parameters	RUN   STOP   PAUSE   STEP   REStart
Parameter Format	<cr>
Example	PROG:TRAN RUN
Query Format	<b>PROG:TRANSient?</b>
Description	Query format returns the transient execution state as either RUN, STOP, PAUS, STEP or REST
Returned Data Format	<cr>
Query Example	PROG:TRAN? RUN
Command Syntax	<b>PROG:TRANSient:AUTORMS &lt;BOOLEAN&gt;</b>
Description	If enabled, the value of any waveform used in a transient segment is normalized in order to match the RMS set point. If disabled, the waveform is reproduced without any normalization. This function is useful for waveform substitution at the steady state level. <b>Note:</b> This function is related to the AUTORMS function in the steady state segment.
Parameters	[ 0   OFF   1   ON ]
Parameter Format	<b>
Example	PROG:TRAN:AUTORMS 1
Query Format	<b>PROG:TRANSient:AUTORMS?</b>
Returned Data Format	<b>
Query Example	PROG:TRAN:AUTORMS? 1
Command Syntax	<b>PROG:TRANSient:CR &lt;BOOLEAN&gt;</b>
Description	This command enables or disables the Cycle Reset mode during transient execution. When on, Cycle Reset will resync each transient run in repeat mode to the start phase angle.
Parameters	[ 0   OFF   1   ON ]
Parameter Format	<b>
Example	PROG:TRAN:CR 1
Query Format	<b>PROG:TRANSient:CR?</b>
Returned Data Format	<nr1>
Query Example	PROG:TRAN:CR? 0

<p>Command Syntax Description</p>	<p><b>PROG:TRANSient:HOLD &lt;ON OFF&gt;</b> This commands turns the Transient HOLD mode on or off. If ON, the power source holds the last segment values at steady state after the transient ends. If OFF, the output of the power source returns to the steady state settings in effect before the transient segment ran.</p>
<p>Parameters Parameter Format Example Query Format Returned Data Format Query Example</p>	<p>[ 0   OFF   1   ON] &lt;cr&gt;   &lt;b&gt; PROG:TRAN:HOLD ON <b>PROG:TRANSient:HOLD?</b> &lt;b&gt; PROG:TRAN:MODE? 1</p>
<p>Command Syntax Description</p>	<p><b>PROG:TRANSient:MODE</b> This commands selected between legacy UPC controller mode SEGMENT transient mode or STEP mode. Segment mode is backward compatible with PPS UPC controllers and use a steady state table and a transient table for each segment. A total of 99 segments can be programmed. STEP mode uses the conventional SCPI LIST system of a list of transient steps executed sequentially.</p>
<p>Parameters Parameter Format Example Query Format Returned Data Format Query Example</p>	<p>[ 0   SEGMENT   1   STEP] &lt;cr&gt; PROG:TRAN:MODE STEP <b>PROG:TRANSient:MODE?</b> &lt;nr1&gt; PROG:TRAN:MODE? 1</p>
<p>Query Format Description</p>	<p><b>PROG:TRANSient:PROGress?</b> This command returns the progress status of a running transient. The response data content depends on the selected transient mode, SEGMENT or STEP. (Refer to the “PROG:TRANSient:MODE” command) The following information is returned in the order shown below. Values are separated by a “/” character:</p>
<p>Return Data Format</p>	<p>A. Progress as a percent of the total between 0 to 100. B. Current element progress. A percent between 0 and 100 of the element executing. C. Active step or segment in execution. D. Active step or segment time. In multiples of 0.2 ms. E. Total time. In multiples of 0.2 ms. F. Total number of steps or segments.</p>
<p>Returned Data Format Query Example</p>	<p>&lt;nr1&gt; / &lt;nr1&gt; / &lt;nr1&gt; / &lt;nr1&gt; / &lt;nr1&gt; / &lt;nr1&gt; PROG:TRAN:PROG? 57/31/3/1554/20000/4</p>
<p><i>Continues next page</i></p>	

Query Format

**PROG:TRANSient:PROGress?**

TRANSIENT TABLE

TRANSIENT MODE

STEP

SEGMENT

#	TIME [ms]	FREQ [Hz]	V <sub>AC</sub> [V <sub>RMS</sub> ] A/B/C	V <sub>DC</sub> [V] A/B/C	Phase [deg] B/C
> 1	1000.0	60.00	0.00	0.00	120.00/240.0
> 2	1000.0	60.00	0.00	0.00	120.00/240.0
> 3	1000.0	60.00	0.00	0.00	120.00/240.0
> 4	1000.0	60.00	0.00	0.00	120.00/240.0

Example Return data for transient table shown above in STEP mode would be 57/31/3/1554/20000/4

- A. Progress = 57% of total time or  $0.57 * 4000 \text{ ms} = 2280 \text{ ms}$
- B. Current element progress = 31% or  $0.31 * 1000 \text{ ms} = 310 \text{ ms}$
- C. Active step = 3
- D. Active step time =  $1554 * 0.2 \text{ ms} = 310.8 \text{ ms}$
- E. Total time =  $20000 * 0.2 \text{ ms} = 4000 \text{ ms}$
- F. Total number of steps = 4.

Relationship between data fields

$$A = (((\text{Summing of the element times between 1 and C-1}) / 0.2 + D) / E) * 100$$

For the example  $A = ((1000+1000)/0.2+1554)/20000 = 57\%$

$$B = (D / (\text{Time of the element C} / 0.2)) * 100$$

For the example  $B = (1554/(1000/0.2))*100 = 31\%$

Query Format

**PROG:TRANSient:EIE?**

Description

This query command returns the active Element In Execution. An element is either a STEP when in transient STEP mode or a SEGMENT when in transient SEGMENT mode.

Note: the data returned on this query is the same as the “C” data returned by the “PROG:TRANSient:PROGress?” command.

Returned Data Format

<nr1>

Query Example

PROG:TRAN:EIE?

3

Query Format

**PROG:TRANSient:ETE?**

Description

This query command returns the active Element To Execute. An element is either a STEP when in transient STEP mode or a SEGMENT when in transient SEGMENT mode.

The ETE query is useful when a transient execution has been PAUSED by the “PROG:TRANSient PAUSE” command. For example, if the execution is paused in the middle of an element (step or segment) execution for element “n”, the ETE value will be “n”. If it is paused at the end of element “n”, the ETE value will be “n+1”.

Returned Data Format

<nr1>

Query Example

PROG:TRAN:ETE?

4

<p>Command Syntax Description</p>	<p><b>PROG:TRANsient:MODE</b></p> <p>This commands selected between legacy UPC controller mode SEGMENT transient mode or STEP mode. Segment mode is backward compatible with PPS UPC controllers and use a steady state table and a transient table for each segment. A total of 99 segments can be programmed. STEP mode uses the conventional SCPI LIST system of a list of transient steps executed sequentially.</p>
<p>Parameters Parameter Format Example Query Format Returned Data Format Query Example</p>	<p>&lt; 0   SEGMENT   1   STEP &gt;</p> <p>&lt;cr&gt;</p> <p>PROG:TRAN:MODE STEP</p> <p><b>PROG:TRANsient:MODE?</b></p> <p>&lt;cr&gt;</p> <p>PROG:TRAN:MODE?</p> <p>1</p>
<p>Command Syntax Description</p>	<p><b>PROG:TRANsient:CSC</b></p> <p>This command turns the CSC Mode during transient execution on (1) or off (0). This allows load regulation adjustment during transient execution. However, keep in mind that CSC adjustments are based on RMS voltage measurement, which take several cycles to run so turning on CSC on fast changing voltage transients is not recommended as the CSC may interfere with the programmed transient voltages.</p> <p><b>Note 1:</b> In UPC compatibility mode, the CSC is always off during transient execution regardless of this setting to match the UPC controller operation.</p> <p><b>Note 2:</b> This command is available on units with firmware revision 1.3.0 or higher.</p>
<p>Parameters Parameter Format Example Query Format Returned Data Format Query Example</p>	<p>&lt; 0   OFF   1   ON &gt;</p> <p>&lt;cr&gt;</p> <p>PROG:TRAN:CSC ON</p> <p><b>PROG:TRANsient:CSC?</b></p> <p>&lt;cr&gt;</p> <p>PROG:TRAN:CSC?</p> <p>1</p>

Command Syntax	<b>PROG:TRAN:FROM</b>
Description	This command sets the first transient step number at which step mode execution is to begin. The step specified must exist or an error message will be generated.
Parameters	STEP number from 1 ~ 99
Parameter Format	<nr1>
Example	PROG:TRAN:FROM 5
Query Format	<b>PROG:TRAN:FROM?</b>
Returned Data Format	<nr1>
Query Example	PROG:TRAN:FROM? 5
Command Syntax	<b>PROG:TRAN:TO</b>
Description	This command sets the transient step number at which step mode execution is to end. The step specified must exist or an error message will be generated.
Parameters	STEP number from 1 ~ 99
Parameter Format	<nr1>
Example	PROG:TRAN:TO 25
Query Format	<b>PROG:TRAN:TO?</b>
Returned Data Format	<nr1>
Query Example	PROG:TRAN:TO? 25
Command Syntax	<b>PROG:TRAN:EVENTs &lt;nr1&gt;</b>
Description	This command sets the number of repetitions for executing the selected transient. A zero value is equivalent to infinite execution until aborted by "PROG:TRAN STOP" command.
Parameters	Repetition, range is 0 ~ 99999
Parameter Format	<nr1>
Example	PROG:TRAN:EVEN 5
Query Format	<b>PROG:TRAN:EVENTs?</b>
Returned Data Format	<nr1>
Query Example	PROG:TRAN:EVEN? 5
Command Syntax	<b>PROG:TRAN:GOTO &lt;nr1&gt;</b>
Description	This command forces transient execution to move to the element argument passed (STEP in STEP mode or SEGMENT in segment mode).
Parameters	ELEMENT
Parameter Format	<nr1>
Example	PROG:TRAN:GOTO 3

### 8.6.4 Memory Management Commands

The Program memory subsystem commands allow management of Program memory contents.

Command Syntax	<b>PROG:MEMory &lt;cr&gt;</b>
Description	This command selects the specific program memory type for storing and retrieving programs. Default is INTERNAL memory. Alternatives are RAM and USB devices. The memory type can also be specified as an optional parameter with several PROG:MEM commands where indicated in this manual.
Parameters	Memory types: INTERNAL   RAM   USB. For a complete list of available memory types, use the "PROG:MEMory:CATalog?" Command.
Parameter Format	<cr>
Example	PROG:MEM USB
Query Format	<b>PROG:MEMory?</b>
Returned Data Format	<cr>
Query Example	PROG:MEM? USB
Query Format	<b>PROG:MEMory:CATalog?</b>
Description	This query command returns a comma separated list of available memory types that can be selected for storage of steady state and transient table information.
Returned Data Format	INTERNAL, RAM, SD1, SD2, SD3, USB
Memory Types	INTERNAL = Internal Flash Memory. (Default selection) RAM = Internal RAM. Content will be lost when power source is turned off. USB[X][Y] = USB memory stick devices. X = port number, Y = partition number SD[Y] = SC Card, Y = partition number X = symbolizes different memory sticks connected to various available USB ports. Y = symbolizes different logical partitions on a USB memory stick or SD card. INTERNAL and RAM are always available. INTERNAL is default selection. Use the "PROG:MEMory <cr>" command to select active memory selection.
Query Example	PROG:MEM:CAT? INTERNAL,RAM,USBA1

<p>Query Format Description</p>	<p><b>PROG:EXECuted:MEMory?</b></p> <p>This command selects the specific program memory type for storing and retrieving programs. Default is INTERNAL memory. Alternatives are RAM and USB devices. The memory type can also be specified as an optional parameter with several PROG:EXEC commands where indicated in this manual.</p>
<p>Parameters Parameter Format Example Query Format Returned Data Format Query Example</p>	<p>Memory types: INTERNAL   RAM   USB</p> <p>&lt;cr&gt;</p> <p>PROG:EXEC:MEM USB</p> <p><b>PROG:EXECuted:MEMory?</b></p> <p>&lt;cr&gt;</p> <p>PROG:EXEC:MEM?</p> <p>USB</p>
<p>Command Syntax Description</p>	<p><b>PROG:POWOn &lt;nr1&gt;</b></p> <p>Returns the number of the stored program that will be recalled at power on.</p>
<p>Parameters Parameter Format Example Query Format Returned Data Format Query Example</p>	<p>Program number</p> <p>&lt;nr1&gt;</p> <p>PROG:POWO 1</p> <p><b>PROG:POWOn?</b></p> <p>&lt;nr1&gt;</p> <p>PROG:POWO?</p> <p>1</p>
<p>Command Syntax Description</p>	<p><b>PROG:DELeTe:ALL &lt;cr&gt;</b></p> <p>This command deletes all programs, waveforms and setup values, performs device RESET, loads Program #1 with *RST default values, executes MANUAL MODE with *RST values. Waveforms (1-16) are re-loaded from internal Flash memory. Attempting to DELeTe an EXECuting Program will result in an error message.</p>
<p>Parameters Parameter Format Example</p>	<p>Optional: Memory type: INTERNAL   RAM   USB</p> <p>&lt;cr&gt;</p> <p>PROG:DEL:ALL USB</p>
<p>Query Format Description</p>	<p><b>PROG:CATalog? &lt;cr&gt;</b></p> <p>This query returns a comma separated list of &lt;nr1&gt; values representing stored programs (e.g. 1,2,7...). If the MANUAL MODE program setup exists, the list will include 0. If no programs are stored at all, this query returns a 1</p>
<p>Parameters Parameter Format Returned Data Format Query Example</p>	<p>Optional: Memory type: INTERNAL   RAM   USB</p> <p>&lt;cr&gt;</p> <p>&lt;nr1&gt;,&lt;nr1&gt;,...,&lt;nr1&gt;,&lt;nr1&gt;</p> <p>PROG:CAT?</p> <p>0,1,2,9,12</p> <p>PROG:CAT? INTERNAL</p> <p>0</p>

---

Query Format	<b>PROG:CRc? &lt;cr&gt;</b>
Description	This query command calculates and returns the checksum value of the selected program. This CRC may be used to verify the program data integrity is intact. This command is provided for UPC compatibility mode and not recommended for new programs.
Parameters	Optional: Memory type: INTERNAL   RAM   USB
Parameter Format	<cr>
Returned Data Format	<nr1>
Query Example	PROG:CRc? RAM 08ad55
Query Format	<b>PROG:BRoWse?</b>
Description	This command returns the list of available programs stored in the memory selected or passed as a parameter.
Parameters	Optional: Memory type: INTERNAL   RAM   USB
Parameter Format	<cr>
Returned Data Format	<nr1>, <nr1>,.....,<nr1>
Query Example	PROG:BRoW? 1,8,9,23



## 8.7 Source Commands

Source commands control the settings of the power source. This includes all operating modes, voltages, frequency, current and power limits and phase angles as well as transient operation. Since the SOURCE subsystem is the primary system, the SOURce portion of these commands is optional. The following status commands are supported broken down by SOURCE sub groups.

### 8.7.1 Source Configuration Programming Commands

Command Syntax	<b>[SOURce:]CONFIG &lt;b&gt;</b>
Description	Selects alternative loop compensation mode for improved transient response. The effect of this command depends on the selected output mode as follows:
Parameters	AC Mode:           Changes the AC loop compensation.
Parameter Format	< 0   1 >           ( 0 = Normal loop, 1 = Faster Loop )
Example	<b>
Query Format	SOUR:CONFIG 1
Returned Data Format	<b>[SOURce:]CONFIG?</b>
Query Example	<b>
	CONFIG?
	0
Command Syntax	<b>[SOURce:]CONFIG:AC &lt;b&gt;</b>
Description	Selects alternative AC loop compensation mode for improved AC transient response.
	The effect of this command depends on the selected output mode as follows:
Parameters	AC Mode:           Changes the AC loop compensation
Parameter Format	< 0   1 >           ( 0 = Normal loop, 1 = Faster Loop )
Example	<b>
Query Format	SOUR:CONFIG:AC 1
Returned Data Format	<b>[SOURce:]CONFIG:AC?</b>
Query Example	<b>
	CONFIG:AC?
	0

---

Command Syntax	<b>[SOURCE:]CONFIG:HFreq &lt;b&gt;</b>
Description	This command enables high-frequency output current protection extension mode. In this mode, the protection for high frequency content at the output of the power source is held off for up to 2 seconds to allow short time events to ride through without tripping the normal protection mode. <b>Note:</b> Available in units with Firmware revision 1.6.6 or higher.
Parameters	< 0   OFF   1   ON > ( 0 = Off, 1 = On)
Parameter Format	<b>
Example	SOUR:CONFIG:HF 1
Query Format	<b>[SOURCE:]CONFIG:HFreq?</b>
Returned Data Format	<b>
Query Example	CONFIG:HF? 1

Command Syntax	<b>[SOURce:]INITial &lt;n&gt;</b>
Description	<p>Sets source output settings initialization mode. This command in combination with the "OUTPut[:STATE]:AUTO" command allows the unattended resumption of a test station after a power failure.</p> <p><b>Note:</b> This condition is potentially hazardous and should be used with caution.</p>
[SOURce:]INITial? = ON	<p>Set points of the unit at power on will be the last set after power off. The set points affected by this command are:</p> <ul style="list-style-type: none"> <li>- Frequency</li> <li>- Voltage AC1</li> <li>- Voltage AC2</li> <li>- Voltage AC3</li> <li>- 0</li> <li>- 0</li> <li>- 0</li> <li>- Form (THREE , SPLIT or SINGLE)</li> <li>- Range (High or Low)</li> <li>- Compatibility Mode (UPC or NORMAL)</li> </ul>
[SOURce:]INITial? = OFF	<p>Set points of the unit at power on will have a default value of:</p> <ul style="list-style-type: none"> <li>- Frequency = 60Hz</li> <li>- Voltage AC1 = 0V</li> <li>- Voltage AC2 = 0V</li> <li>- Voltage AC3 = 0V</li> <li>- 0</li> <li>- 0</li> <li>- 0</li> <li>- Form = THREE</li> <li>- Range = HIGH</li> <li>- Compatibility = NORMAL</li> </ul>
Parameters	< 0   OFF   1   ON >
Parameter Format	<b>
Example	:INIT ON
Query Format	<b>[SOURce:]INITial?</b>
Returned Data Format	<b>
Query Example	INIT? 0

<p>Command Syntax Description</p>	<p><b>[SOURce:]RANGe</b> Selects high or low voltage range. Although the LSX Series® has only a single voltage range, this commands allows simulation of a dual range AC voltage source which is more familiar to some users. Despite this virtual low range capability, no actual physical range change takes places so the output is never interrupted. Note: When switching from HIGH to LOW range, the output voltage may be reduced to the highest available voltage on the low range.</p>
<p>Parameters Parameter Format Example Query Format Returned Data Format Query Example</p>	<p>&lt; 0   LOW   1   HIGH &gt; &lt;b&gt; RANG HIGH <b>[SOURce:]RANGe?</b> &lt;b&gt; RANG? 1</p>
<p>Command Syntax Description</p>	<p><b>[SOURce:]RAMP#</b> Sets voltage slew rate for selected phase number or for all phases if no phase number is specified.</p>
<p>Parameters Parameter Format Example Query Format Description Returned Data Format Query Example</p>	<p>Slew rate &lt;nr2&gt; SOUR:RAMP3 10.5 <b>[SOURce:]RAMP#?</b> Returns voltage slew rate setting for specified phase (1, 2 or 3) or for phase 1 (A) if no phase number is specified.  SOUR:RAMP3? 10.5000</p>
<p>Command Syntax Description</p>	<p><b>[SOURce:]UPDATEPHase</b> Set the phase angle at which programmed voltage changes on phase A will take place. This applies to output on and off phase angle placement as well. Available range is from 0° through 360.0° inclusive. Values higher than 360.0° will be truncated to 360.0000° automatically.</p>
<p>Parameters Parameter Format Example Query Format Returned Data Format Query Example</p>	<p>&lt; 0.0000 - 360.0000 &gt; &lt;nr2&gt; UPDATEPH 90.00 <b>[SOURce:]UPDATEPHase?</b> &lt;nr2&gt; SOURce:UPDATEPH? 90.0000</p>

### 8.7.2 Voltage Programming Commands

Note that most of the voltage programming commands are phase specific so in three or split phase mode, each phase voltage can be individually programmed. This is done by appending 1, 2 or 3 for the “#” symbol shown in the syntax below. If the “#” value is omitted, all available phase (1, 2 or 3 in single, split or three phase mode respectively) will be set to the same amplitude. This allows the same program code to be used for any phase mode as long as the phase amplitudes need to be balanced.

The following command sets each phase to a different amplitude when in three phase mode.

```
SOUR:VOLT:AC1 15;;SOUR:VOLT:AC2 30;;SOURCE:VOLT:AC3 45
```

This command sets all phases to the same amplitude, regardless of phase mode:

```
SOUR:VOLT:AC 100
```

The query format for these phase specific commands will return the value for the phase number appended to the command. If the phase number reference is omitted, the setting for phase 1 (A) is returned.

Command Syntax	<b>[SOURCE:]VOLTage:CSC[:STATE#]</b> <b>[SOURCE:]CSC:STATE#</b>
Description	Turns the Continuous Source Calibration (CSC) mode on or off.
Parameters	<0   OFF   1   ON>
Parameter Format	<b>
Example	VOLT:CSC ON
Query Format	<b>[SOURCE:]VOLTage:CSC[:STATE]?</b>
Returned Data Format	<nr1>
Query Example	VOLT:CSC? 1
Command Syntax	<b>[SOURCE:]VOLTage[:AC]#</b>
Description	Sets AC voltage for phase #. If # is omitted, sets all available phases to value specified.
Parameters	Range 0.0000 - 300.0000
Parameter Format	<nr2>
Example	VOLT:AC1 100.00
Query Format	<b>[SOURCE:]VOLTage[:AC]#?</b>
Description	Returns voltage setting for specified phase. If phase is omitted, returns voltage setting for phase A.
Returned Data Format	<nr2>
Query Example	VOLT:AC1? 100.0000

Command Syntax	<b>[SOURce:]VOLTage[:AC]#:SLEW</b>
Description	Sets AC voltage slew rate for phase # in Volts per msec. If # is omitted, sets phase A slew rate to value specified.
Parameters	Range 0.01 – 300.0
Parameter Format	<nr2> and <nr3>
Example	VOLT:AC1:SLEW 300.00
Query Format	<b>[SOURce:]VOLTage[:AC]#:SLEW?</b>
Description	Returns voltage slew rate setting for specified phase. If phase is omitted, returns voltage setting for phase A.
Returned Data Format	<nr2>
Query Example	VOLT:AC1:SLEW? 300.0000
Command Syntax	<b>[SOURce:]VOLTage[:AC]:LIMit:MINimum</b>
Description	Sets low user limit for AC voltage programming. User limits must fall within actual hardware limits of the power source. Also, MIN limit must be less than MAX limit.
Parameters	0.000 – 300.000
Parameter Format	<nr2>
Example	VOLT:LIM:MIN 20.0
Query Format	<b>[SOURce:]VOLTage[:AC]#:LIMit:MINimum?</b>
Returned Data Format	<nr2>
Query Example	VOLT:LIM:MIN? 20.0000
Command Syntax	<b>[SOURce:]VOLTage[:AC]:LIMit:MAXimum</b>
Description	Sets high user limit for AC voltage programming. User limits must fall within actual hardware limits of the power source. Also, MAX limit must be greater than MIN limit.
Parameters	0.000 – 300.000
Parameter Format	<nr2>
Example	VOLT:LIM:MAX 240.0
Query Format	<b>[SOURce:]VOLTage[:AC]#:LIMit:MAXimum?</b>
Returned Data Format	<nr2>
Query Example	VOLT:LIM:MAX? 240.0000
Query Format	<b>[SOURce:]VOLTage[:AC]#:LIMit:RANGe?</b>
Description	Returns available AC voltage range low and high limits.
Returned Data Format	<nr2>,<nr2>
Query Example	VOLT:AC1:LIM:RANG? 0.0000,300.0000

Query Format Description	<p><b>[SOURCE:]VOLTage[:AC]#:LIMIT:SATuration:RANGe?</b></p> <p>Returns the upper and lower limit sine wave RMS voltage at which saturation of the output inverter will occur. Saturation limits are determined in the maximum peak voltage capability of the AC components at the output of the power source. For the LSX Series®, these limits are -425Vp and +425Vp. The VOLT:AC1:LIM:SAT:RANG? returns the min and max. RMS of a sine wave that may be programmed.</p> <p>Maximum allowable values are:  Maximum positive peak voltage:  <math>V\_peak\_max = V\_AC\_peak\_max</math>  Minimum negative peak voltage:  <math>V\_peak\_min = V\_AC\_peak\_min</math>  For a sinusoidal AC waveform, these limits are:  <math>V_{rms\_sat} = (425 - V_{dc}) / 1.4142</math>  <math>V_{rms\_sat} = (-425 + V_{dc}) / 1.4142</math>  <math>425 = 1.41 * 300</math> (<math>V\_AC\_rms\_sat = 300</math>)</p>
Examples	
Returned Data Format Query Example	<p>&lt;nr2&gt;  VOLT:AC3:LIM:SAT:RANG?  300.5204</p>
Query Format Description	<p><b>[SOURCE:]VOLTage[:AC]#:LIMIT:SATuration:MAXimum?</b></p> <p>Returns maximum sine wave RMS voltage at which saturation of the output inverter will occur.  See [SOURCE:]VOLTage[:AC]#:LIMIT:SATuration:RANGe? for details.</p>
Returned Data Format Query Example	<p>&lt;nr2&gt;  VOLT:AC3:LIM:SAT:MAX?  301.154</p>
Query Format Description	<p><b>[SOURCE:]VOLTage[:AC]#:LIMIT:SATuration:MINimum?</b></p> <p>Returns minimum sine wave RMS voltage at which saturation of the output inverter will occur.  See [SOURCE:]VOLTage[:AC]#:LIMIT:SATuration:RANGe? for details.</p>
Returned Data Format Query Example	<p>&lt;nr2&gt;  VOLT:AC3:LIM:SAT:MIN?  0.000</p>

Command Syntax	<b>[SOURce:]VOLTage[:AC]:INITial</b>
Description	This command is equivalent to the “[SOURce:]INITial <n>” command but applies only to the AC1, AC2 and AC3 parameters.
VOLT:INIT? = ON	Set points of the unit at power on will be the last set after power off. The set points affected by this command are: - Voltage AC1 - Voltage AC2 - Voltage AC3
VOLT:INIT? = OFF	Set points of the unit at power on will have a default value of: - Voltage AC1 = 0V - Voltage AC2 = 0V - Voltage AC3 = 0V
Parameters	< 0   OFF   1   ON >
Parameter Format	<b>
Example	VOLT:AC:INIT OFF
Query Format	<b>[SOURce:]VOLTage[:AC]:INITial?</b>
Returned Data Format	<b>
Query Example	VOLT:AC:INIT? 0
Command Syntax	<b>[SOURce:]VPEAK:MARGin</b>
Description	This command sets the over voltage protection trip level as an absolute value. Thus, if the output voltage exceeds the programmed voltage + the Vpeak Margin, the OVP protection will trip off the output and generate an OVP fault. For example., if 230Vrms is programmed in AC mode and the Vpeak margin is set to 20, the OVP will trip at $230 * \sqrt{2} + 20 = 345V_{peak}$ .
Parameters	0.0 – 500.0
Parameter Format	<nr2>
Example	VPEAK:MARG 20.0
Query Format	<b>[SOURce:]VPEAK:MARGin?</b>
Returned Data Format	<nr2>
Query Example	VPEAK:MARG? 20.0000



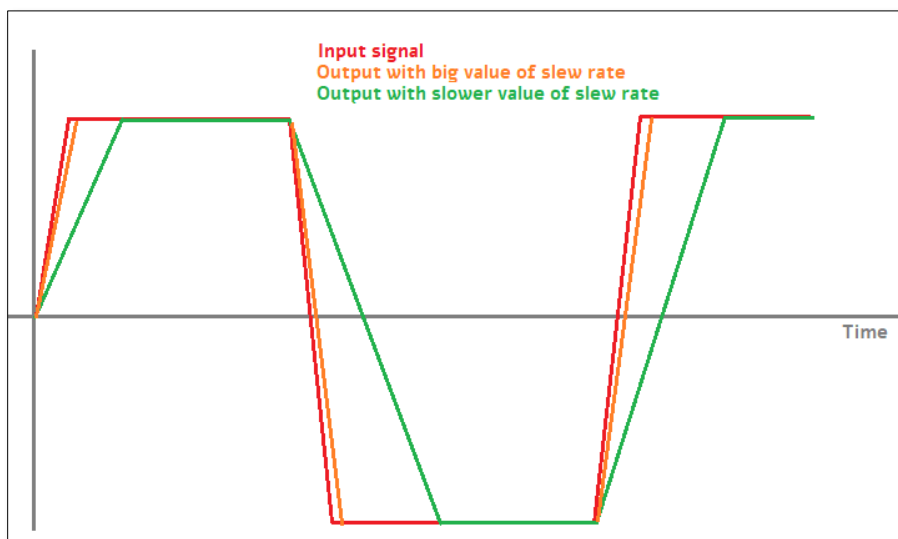
---

Command Syntax	<b>[SOURce:]VOLTage:EXTend</b>
Description	Available only on LSX models with Option V. This command grants access to a higher voltage range extension mode. When enabled, AC voltage settings up to 333V L-N are supported.
Parameters	[ 0   OFF   1   2 ] 0 = Off, 312Vac max. 1 = 320Vac max 2 = 333Vac max
Parameter Format	<bool>
Example	VOLT:EXT 1
Query Format	<b>[SOURce:]VOLTage:EXTend?</b>
Returned Data Format	<nr1>
Query Example	VOLT:EXT? 1

### 8.7.3 Real Time Voltage Slew Rate Programming Commands

The voltage slew rate settings are intended for use with analog input AC or DC voltage programming when in Source mode of operation. In analog programming mode, the output is the amplified input with the rise time limited by this programmable slew rate setting or by the power stage response time. (100us approx.). Do not confuse these commands with the programmable voltage slew rates for voltage settings, see **[SOURCE:]VOLTage[:AC]#:SLEW** in section 8.7.2.

By default this setting is at the maximum, so the output voltage would be the most similar to the input plus the response of the output stage. See the picture below where this slew rate is used to limit the rise time of the output regardless of input.



Command Syntax	<b>[SOURCE:]SLEW:VOLTage &lt;nr2&gt;</b>
Description	Sets the maximum real-time voltage slew rate value associated with analog programming mode.
Parameters	Voltage slew rate
Parameter Format	<nr2>
Example	CURR:AC:SLEW 10.00
Query Format	<b>[SOURCE:]SLEW:VOLTage?</b>
Description	Returns voltage slew rate setting for all phases.
Returned Data Format	<nr2>
Query Example	SLEW:VOLT? 10.0000

---

Query Syntax	<b>[SOURce:]SLEW:VOLTage:MINimum?</b>
Description	Returns the minimum real-time voltage slew rate setting associated with analog programming mode.
Returned Data Format	<nr2>
Query Example	SLEW:VOLT:MIN? 0.010
Query Syntax	<b>[SOURce:]SLEW:VOLTage:MAXimum?</b>
Description	Returns the maximum real-time voltage slew rate setting associated with analog programming mode.
Returned Data Format	<nr2>
Query Example	SLEW:VOLT:MAX? 0.010
Query Syntax	<b>[SOURce:]SLEW:VOLTage:DEFault?</b>
Description	Returns the default real-time voltage slew rate setting associated with analog programming mode.
Returned Data Format	<nr2>
Query Example	SLEW:VOLT:DEF? 0.010

### 8.7.4 Frequency Programming Commands

Command Syntax	<b>[SOURCE:]FREQUENCY</b>
Description	Sets output frequency for all phases.
Parameters	15.00 – 1200.0 <i>Range is adjust on models with T Option</i>
Parameter Format	<nr2>
Example	FREQ 400.0
Query Format	<b>[SOURCE:]FREQUENCY?</b>
Returned Data Format	<nr2>
Query Example	FREQ? 400.0000
Command Syntax	<b>[SOURCE:]FREQUENCY:LIMIT:MINIMUM</b>
Description	Sets the lower user limit for frequency programming. Note that the lower limit set value must be less than the upper limit set value or an error will be generated and no change to the set value will take place. The lower limit set value must fall within the source specified frequency range capability.
Parameters	15.00 – 1200.0 <i>Range is adjust on models with T Option</i>
Parameter Format	<nr2>
Example	FREQ:LIM:MIN 47.0
Query Format	<b>[SOURCE:]FREQUENCY:LIMIT:MINIMUM?</b>
Returned Data Format	<nr2>
Query Example	FREQ:LIM:MIN? 47.0000
Command Syntax	<b>[SOURCE:]FREQUENCY:LIMIT:MAXIMUM</b>
Description	Sets the upper user limit for frequency programming. Note that the upper limit set value must be greater than the lower limit set value or an error will be generated and no change to the set value will take place. The upper limit set value must fall within the source specified frequency range capability.
Parameters	15.00 – 1200.0 <i>Range is adjust on models with T Option</i>
Parameter Format	<nr2>
Example	FREQ:LIM:MAX 63.0
Query Format	<b>[SOURCE:]FREQUENCY:LIMIT:MAXIMUM?</b>
Returned Data Format	<nr2>
Query Example	FREQ:LIM:MAX? 63.0000

Query Format **[SOURCE:]FREQUENCY:LIMIT:RANGE?**  
 Description This command returns the lower and upper frequency user limit set values  
 Returned Data Format <nr2>, <nr2>  
 Query Example **FREQ:LIM:RANG?**  
 53.0000,63.0000

Command Syntax **[SOURCE:]FREQUENCY:SLEW**  
 Description Sets the frequency slew rate in Hz/msec.  
 Parameters 0.01 – 1200.00  
 Parameter Format <nr2>  
 Example **FREQ:SLEW 100.0**  
 Query Format **[SOURCE:]FREQUENCY:SLEW?**  
 Returned Data Format <nr2>  
 Query Example **FREQ:SLEW?**  
 100.0000

Query Format **[SOURCE:]FREQUENCY:SPAN?**  
 Description This command is provided to support backward compatibility with Pacific Power UPC controllers. Refer also to the “**SYSTEM:COMPATIBLE**” command. For LSX Series®, this query always returns 1200.0000  
 Returned Data Format <nr2>  
 Query Example **FREQ:SPAN?**  
 1200.0000

### 8.7.5 Current Programming Commands

Command Syntax **[SOURCE:]CURRENT:LIMIT#**  
 Description This command sets the programmable current level for the selected phase #. If # is omitted, sets all phases to current level specified. The value set cannot exceed the maximum current capability of the power source as returned by the “**[SOURCE:]CURRENT:LIMIT#:MAX?**” command.  
 If the load current exceeds the current limit set point, the source will go into constant current mode to maintain the load current at the set limit level.  
 Parameters 0.00 – MAX  
 Parameter Format <nr2>  
 Example **CURR:LIM 20.5**  
 Query Format **[SOURCE:]CURRENT:LIMIT#?**  
 Returned Data Format <nr2>  
 Query Example **CURR:LIM?**  
 41.667,41.667,41.667

Query Format	<b>[SOURce:]CURRent:LIMit#:MAXimum?</b>
Description	This command returns the maximum available programmable current limit setting. Note that the returned value is a function of the “ <b>SYSTem:COMPAtible</b> ” setting
	UPC If UPC mode is enabled, this command always returns 2000.0000 to emulate the UPC controllers
	DISABLED With UPC mode disabled, this command returns the max. available current output per phase. This value is a function of the LSX model and the number of units that are connected in parallel.
Returned Data Format	<nr2>
Query Example	CURR:LIM:MAX? 41.6667
Query Format	<b>[SOURce:]CURRent:LIMit#:DEFault?</b>
Description	This command returns the default current limit setting at power up for the referenced phase.
Returned Data Format	<nr2>
Query Example	CURR:LIM1:DEF? 41.67
Query Format	<b>[SOURce:]CURRent:LIMit#:MINimum?</b>
Description	This command returns the minimum current limit setting available for the referenced phase.
Returned Data Format	<nr2>
Query Example	CURR:LIM:MIN1? 0.000
Command Syntax	<b>[SOURce:]CURRent:PROTect:TOUT</b>
Description	This command sets the programmable delay to hold off when the current trip protection level is exceeded. If the load current remains at or above this current level during this time period, the output will turn off at the end of the time delay. Note: This command serves the same purpose as the “[SOURce:]PROTect”TDELAY” command and is provided for backward compatibility with PPS UPC controllers.
Parameters	0 – 65535
Parameter Format	<nr1>
Example	CURR:PROT:TOUT 2
Query Format	<b>[SOURce:]CURRent:PROTect:TOUT?</b>
Returned Data Format	<nr1>
Query Example	CURR:PROT:TOUT? 2

<p>Command Syntax Description</p>	<p><b>[SOURCE:]CURRENT:PROTECT:LEVEL</b></p> <p>This command sets the programmable current trip level for all phases. The value set cannot exceed the maximum current capability of the power source as returned by the “<b>[SOURCE:]CURRENT:LIMIT#:MAX?</b>” command.</p> <p>If the load current exceeds the current trip set point, the source will turn off its output after the “<b>CURRENT:PROTECT:TOUT</b>” delay time outs and generate a fault message.</p>
<p>Parameters Parameter Format Example Query Format Returned Data Format Query Example</p>	<p>0.00 – MAX &lt;nr2&gt; CURR:PROT:LEV 24.0000 <b>[SOURCE:]CURRENT:PROTECT:LEVEL?</b> &lt;nr2&gt; CURR:PROT:LEV? 24.0000</p>
<p>Command Syntax Description Parameters Parameter Format Example Query Format Returned Data Format Query Example</p>	<p><b>[SOURCE:]CURRENT:OVERLOAD</b></p> <p>This command turns the overload current mode on or off</p> <p>[ 0   OFF   1   ON ] &lt;b&gt; SOUR:CURR:OV ON <b>[SOURCE:]CURRENT:OVERLOAD?</b> &lt;b&gt; CURR:OV? 1</p>
<p>Command Syntax Description Parameters Parameter Format Example Query Format Returned Data Format Query Example</p>	<p><b>[SOURCE:]IPROTECT:STATE</b></p> <p>This command turns the current protection mode on or off</p> <p>[ 0   OFF   1   ON ] &lt;b&gt; IPROT:STAT ON <b>[SOURCE:]IPROTECT:STATE?</b> &lt;b&gt; IPROT:STAT? 1</p>
<p>Query Format Description Returned Data Format Query Example</p>	<p><b>[SOURCE:]IPROTECT:TRIPPED?</b></p> <p>This command returns the current protection state. If the peak current protection has been tripped, a 1 is returned.</p> <p>&lt;b&gt; IPROT:TRIP? 0</p>

Command Syntax	<b>[SOURCE:]IPEAK:PROTECT:STATE</b>
Description	This command enables or disables the user programmable current protection mode.
Parameters	[ 0   OFF   1   ON ]
Parameter Format	<b>
Example	IPEAK:PROT:STAT 1
Query Format	<b>[SOURCE:]IPEAK:PROTECT:STATE?</b>
Returned Data Format	<nr1>
Query Example	IPEAK:PROT:STAT? 1

Command Syntax	<b>[SOURCE:]IPEAK:PROTECT:LEVEL</b>
Description	This command sets user programmable the peak current protection mode level.
Parameters	0.0000 – 100000.0000
Parameter Format	<nr2>
Example	IPEAK:LIM 50.0
Query Format	<b>[SOURCE:]IPEAK:PROTECT:LEVEL?</b>
Returned Data Format	<nr2>
Query Example	IPEAK:PROT:LEV? 50.000

### 8.7.6 Phase Programming Commands

Command Syntax	<b>[SOURCE:]PHASE#</b>
Description	This command programs the phase angle for the selected phase. A phase reference (#) must be specified. <b>Note</b> that unless external sync mode is used, the A phase (# = 1) cannot be programmed is fixed at 0 degrees.
Parameters	0.0 – 359.9
Parameter Format	<nr2>
Example	PHAS2 122.5
Query Format	<b>[SOURCE:]PHASE#?</b>
Returned Data Format	<nr2>
Query Example	PHAS2? 122.5

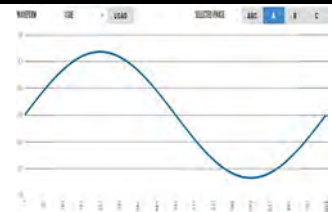
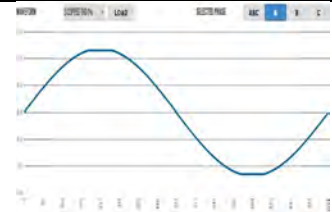
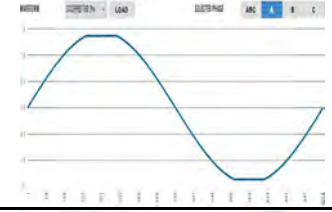
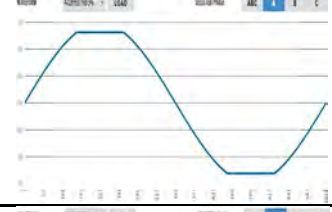
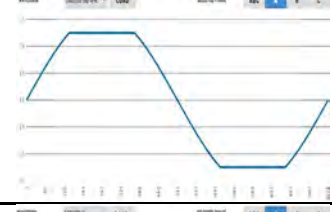



<p>Command Syntax Description</p>	<p><b>[SOURCE:]PHASe#:SLEW</b></p> <p>This command sets slew rate for the phase angle for the selected phase. A phase reference (#) must be specified.  <b>Note</b> that unless external sync mode is used, the A phase (# = 1) slew rate cannot be programmed is fixed at 0 degrees.</p>
<p>Parameters</p>	0.01 – 359.91
<p>Parameter Format</p>	<nr2>
<p>Example</p>	PHAS3:SLEW 10.25
<p>Query Format</p>	<b>[SOURCE:]PHASe#:SLEW?</b>
<p>Returned Data Format</p>	<nr2>
<p>Query Example</p>	PHAS3:SLEW? 10.2500
<p>Command Syntax Description</p>	<p><b>[SOURCE:]PHASe:ROTation &lt;b&gt;</b></p> <p>This command sets default phase rotation at power on. Available settings are POSITIVE (1) or NEGATIVE (0). This setting effectively swaps phases B and C and may be used to set the required phase rotation for AC motors.</p>
<p>Parameters</p>	[ 0   NEGative   1   POSitive] 0 = NEGATIVE 1 = POSITIVE
<p>Parameter Format</p>	<b>
<p>Example</p>	PHAS:ROT POS
<p>Query Format</p>	<b>[SOURCE:]PHASe:ROTation?</b>
<p>Returned Data Format</p>	<b>
<p>Query Example</p>	PHAS:ROT? 1
<p>Command Syntax Description</p>	<p><b>[SOURCE:]PHASe:SPLIT &lt;b&gt;</b></p> <p>This command sets the split phase mirroring mode. This mode allows non-symmetrical AC arbitrary waveforms to be used when in split phase mode. Default state is on.</p>
<p>Parameters</p>	[ 0   OFF   1   ON] 0 = OFF 1 = ON
<p>Parameter Format</p>	<b>
<p>Example</p>	PHAS:SPLIT ON
<p>Query Format</p>	<b>[SOURCE:]PHASe:SPLIT?</b>
<p>Returned Data Format</p>	<b>
<p>Query Example</p>	PHAS:SPLIT? 1

### 8.7.7 Waveform Programming Commands

#### Waveform Storage

The LSX Series® offers full arbitrary waveform programming capability in addition to the standard waveforms that are provided. A total of 16 waveform registers are available. The default content of these registers is shown in the table below. Also shown are the waveform number names and the waveform description each waveform.

Name	Description	Image	Notes
1	SINE		Standard sine wave. No harmonic content. This is also the default selected waveform at power on unless a power-on setup is recalled.
2	CLIPPED THD 1%		Clipped sine with 1% total harmonic voltage distortion due to flat topping of sinewave peaks.
3	CLIPPED THD 2%		Clipped sine with 2% total harmonic voltage distortion due to flat topping of sinewave peaks.
4	CLIPPED THD 5%		Clipped sine with 5% total harmonic voltage distortion due to flat topping of sinewave peaks.
5	CLIPPED THD 10%		Clipped sine with 10% total harmonic voltage distortion due to flat topping of sinewave peaks.
6	SQUARE LF		Square wave. Consists of fundamental and all odd harmonics. The LF (low frequency) version is recommended for use below 100Hz.


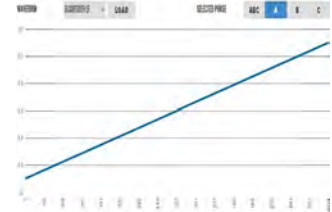
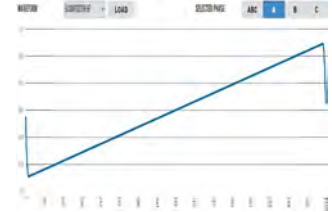
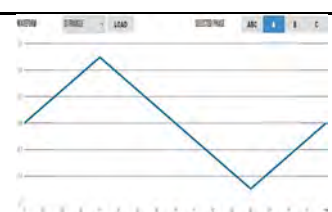
Name	Description	Image	Notes
7	SQUARE HF		Square wave. Consists of fundamental and all odd harmonics. The HF (high frequency) version is recommended for use above 100Hz.
8	SAWTOOTH LF		Saw tooth. Consist of fundamental and both odd and even harmonics. Note: Not recommended for conventional power applications. LF use < 100Hz.
9	SAWTOOTH HF		Saw tooth. Consist of fundamental and both odd and even harmonics. Note: <b>Non-linear!</b> Not recommended for conventional power applications. HF use > 100Hz.
10	TRIANGLE		Triangle. Similar to saw tooth but at same fundamental as a sine wave. Contains fundamental and odd harmonics with amplitudes that roll off as the inverse square of the harmonic number. (1/3, 1/9, 1/25 etc).
11~200	USER DEFINED	Number, ALIAS	User defined waveforms

Table 8-2: Available Included LSX Series® Waveforms

## Commands

<p>Command Syntax Description</p>	<p><b>[SOURCE:]WAVEFORM:AUTORMS &lt;BOOLEAN&gt;</b> If enabled, the value of the waveform is normalized in order to match the RMS set point. If disabled, the waveform is reproduced without any normalization. This function is useful for waveform substitution at the steady state level. <b>Note:</b> This function is related to the AUTORMS function in the transient segment but it is <b>not</b> the same. <b>Note:</b> UPC has AUTORMS always enabled for steady state. It is not an option in UPC Mode.</p>
<p>Parameters Parameter Format Example Query Format Returned Data Format Query Example</p>	<p>0   1   ON   OFF &lt;b&gt; WAVEFORM:AUTORMS OFF <b>[SOURCE:]WAVEFORM:AUTORMS?</b> &lt;b&gt; SOURCE:WAVEFORM:AUTORMS? 0</p>
<p>Query Format Description</p>	<p><b>[SOURCE:]WAVEFORM:CATalog?</b> This command returns the list of available waveforms by name. Names can only be numbers. For more descriptive names, see the <b>.”[SOURCE:]WAVEFORM:CATalog:ALIAS?”</b> command instead.</p>
<p>Returned Data Format Query Example</p>	<p>&lt;cr&gt; WAVEFORM:CAT? 1,2,3,4,5,6,7,8,9,10,11,12,13,14,15,16</p>
<p>Query Format Description</p>	<p><b>[SOURCE:]WAVEFORM:CATalog:ALIAS?</b> This command returns the list of available waveforms by description. For each waveform, both the name (number) and description are returned in a comma separated list.</p>
<p>Returned Data Format Query Example</p>	<p>&lt;cr&gt; WAVEFORM:CAT:ALIAS? Sine,Clipped THD 1%,Clipped THD 2%,Clipped THD 5%,Clipped THD 10%,Square Fast,Square Slow,Sawtooth Fast,Sawtooth Slow,Triangle,Clip 5% THD,Clip 6% THD,Clip 7% THD,Clip 8% THD,Clip 9% THD,Clip 10% THD</p>
<p>Command Syntax Description</p>	<p><b>[SOURCE:]WAVEFORM:COPY</b> This command copies the waveform file specified as a PATH parameter to the waveform number specified. The path name is a delimited string.</p>
<p>Parameters Parameter Format Example</p>	<p>&lt;PATH&gt;,&lt;NUMBER&gt; &lt;cr&gt;,&lt;nr1&gt; WAVEFORM:COPY “internal/waveforms/1.csv”,25</p>

<p>Command Syntax Description</p>	<p><b>[SOURCE:]WAVEFORM:DEFine</b> This command sends a string of 1024 data points that constitute a single period of an arbitrary waveform. The data is sent as a comma separated list of &lt;nr2&gt; values. The waveform name to which to apply the new data values is the first parameter in the list and can be from 1 through 16. <b>Note:</b> Data values are scaled based on an RMS value of 1 so for a sine wave, the max data value is 1.414 and the min data value is -1.414</p>
<p>Parameters Parameter Format Example</p>	<p>1024 data values separated by commas &lt;nr1&gt;,&lt;nr2&gt;, &lt;nr2&gt;,.....,&lt;nr2&gt; WAVEFORM:DEF 16,0.0000,0.0068,0.0135,0.0203,....,-0.0203,-0.0135,-0.0068</p>
<p>Query Format Returned Data Format Query Example</p>	<p><b>[SOURCE:]WAVEFORM:DEFine? &lt;nr1&gt;</b> &lt;nr2&gt;, &lt;nr2&gt;,.....,&lt;nr2&gt; SOURCE:WAVEFORM:DEF? 16 0.0000,0.0068,0.0135,0.0203, .... ,-0.0203,-0.0135,-0.0068</p>
<p>Query Format Description</p>	<p><b>[SOURCE:]WAVEFORM:DEFine:BYALIAS?</b> This command is similar to the WAVEFORM:DEF? query but instead of specifying the waveform name as 1 – 16, the waveform alias name is used to select the waveform. Waveform aliases are passed as a quoted string. E.g. "Sine".</p>
<p>Returned Data Format Query Example</p>	<p>&lt;nr2&gt;, &lt;nr2&gt;,.....,&lt;nr2&gt; WAVEFORM:DEFine:BYALIAS? "Sine" 0.0000,0.0087,0.0174,0.0260,0.0347,....,-0.0260,-0.0174,-0.0087</p>
<p>Command Syntax Description</p>	<p><b>[SOURCE:]WAVEFORM:DELete &lt;nr1&gt;</b> This command deletes a user defined waveform from any location higher than 1.</p>
<p>Parameters Parameter Format Example</p>	<p>Waveform number &lt;nr1&gt; WAVEFORM:DEL 16</p>
<p>Query Format Description</p>	<p><b>[SOURCE:]WAVEFORM:EXIST? &lt;nr1&gt;</b> This command returns a 1 if the waveform location referenced contains waveform data or a 0 is the waveform location is empty (No waveform exists).</p>
<p>Returned Data Format Query Example</p>	<p>&lt;nr1&gt; WAVEFORM:EXIST? 34 0</p>

<p>Command Syntax Description</p>	<p><b>[SOURCE:]WAVEFORM#:LOAD</b> This command loads the currently selected waveform to the actual output register of the controller causing it output the waveform on the selected phase #.</p>
<p>Parameters</p>	<p>1, 2, 3</p>
<p>Parameter Format</p>	<p>&lt;nr1&gt;</p>
<p>Example</p>	<p>WAVEFORM1:LOAD</p>
<p>Query Format</p>	<p><b>[SOURCE:]WAVEFORM#:LOAD? &lt;nr1&gt;</b></p>
<p>Returned Data Format</p>	<p>&lt;nr1&gt;, &lt;cr&gt;</p>
<p>Query Example</p>	<p>SOURce:WAVEFORM1:LOAD? 1 1, Sine</p>
<p>Command Syntax Description</p>	<p><b>[SOURCE:]WAVEFORM:RESTORE</b> This command restores the first 16 waveforms registers by replacing waveform 1 to 16 with the factory defaults. See section 0. <b>Note:</b> This command is useful if waveforms 2 through 15 were overwritten with user-defined waveforms.</p>
<p>Parameters</p>	<p>None</p>
<p>Parameter Format</p>	<p>n/a</p>
<p>Example</p>	<p>WAVEFORM:RESTORE</p>
<p>Query Format</p>	<p><b>None</b></p>
<p>Command Syntax Description</p>	<p><b>[SOURCE:]WAVEFORM#:SElect</b> This command selects a waveform by alias (name) or number. When using the WAVEFORM:x commands, the ALIAS NUMBER is not passed as it uses the selected one. This is to avoid passing the waveform number to every command</p>
<p>Parameters</p>	<p>&lt;ALIAS NUMBER, OPT: ALIAS NUMBER , OPT: ALIAS NUMBER &gt; The first parameter is required. Additional optional waveforms or numbers may be added when operating the source in 2 or 3 phase mode. The waveform selection sequence by phase is A, B, C.</p>
<p>Parameter Format</p>	<p>&lt;cr&gt; or &lt;nr1&gt;</p>
<p>Example</p>	<p>WAVEFORM:SEL SINE WAVEFORM:SEL 1,2,3 WAVEFORM:SEL 5</p>
<p>Query Format</p>	<p><b>[SOURCE:]WAVEFORM#:SElect?</b></p>
<p>Returned Data Format</p>	<p>&lt;cr&gt; or &lt;nr1&gt;</p>
<p>Query Example</p>	<p>WAVEFORM:SEL? 1,1,1 (FORM 3) WAVEFORM:SEL? 1,1 (FORM 2) WAVEFORM:SEL? 1 (FORM 1)</p>

<p>Command Syntax Description</p>	<p><b>[SOURCE:]WAVEFORM:SINEwave</b></p> <p>This command modifies the #1 Sinewave harmonic content to reduce voltage distortion at lower frequencies (&lt; 100Hz). It does so by disabling the 3<sup>rd</sup> Harmonic component that is normally included to improve voltage distortion at high frequencies. Turning this OFF (0) is recommended for Harmonics and Flicker system applications at 50 and 60 Hz. For Avionics and Defense applications at 400Hz or higher, this mode should re-enabled (1). Not that this setting is saved in non-volatile memory and is retained between power on/off cycles of the power source.</p>
<p>Parameters Parameter Format Example Query Format Query Example</p>	<p>&lt;b&gt; n/a SOUR:WAVEFORM:SINE 0 <b>SOURCE:WAVEFORM:SINEwave?</b> SOUR:WAVEFORM:SINE? 0</p>
<p>Command Syntax Description</p>	<p><b>[SOURCE:]WAVEFORM:SMOOTHen &lt;NUMBER&gt;</b></p> <p>This command Sets the smoothing filter size that is applied to the waveform, in sample counts. A value of 1 makes the filter have no effect (Disabled) and the maximum value is 101. Only odd numbers are considered. The type of filter used is a moving-average-filter, or MAF.</p> <p>The smoothing filter is used to reduce slew rates of waveform edges. This is useful in certain applications to make the waveform reproduction more consistent and reduce potential distortion due to the sampling rate of the controller, especially when reproducing waveforms at high frequency.</p>
<p>Parameters Parameter Format Example Query Format Returned Data Format Query Example</p>	<p>NUMBER &lt;nr1&gt; WAVEFORM:SMOOTH 33 <b>[SOURCE:]WAVEFORM:SMOOTHen?</b> &lt;nr1&gt; WAVEFORM:SMOOTH? 33</p>

<p>Command Syntax Description</p>	<p><b>[SOURCE:]WAVEFORM#:NAME</b> Set waveform for selected phase to the waveform name passed as a parameter. If no waveform name parameter is specified, the query format returns the name of the selected waveform. See WAVEFORM#[[:NAME]] command.</p>
<p>Parameters Parameter Format Example Query Format Returned Data Format Query Example</p>	<p>1 – 16 &lt;nr1&gt; WAVEFORM1 4 <b>[SOURCE:]WAVEFORM#:NAME?</b> &lt;nr1&gt; SOUR:WAVEFORM1? 4</p>
<p>Command Syntax Description</p>	<p><b>[SOURCE:]WAVEFORM#:ALIAS</b> Analogous to the WAVEFORM#[[:NAME]] command but in place of the waveform name, the waveform description is passed as a quoted string.</p>
<p>Parameters Parameter Format Example Query Format Description Returned Data Format Query Example</p>	<p>Waveform description as quoted string. &lt;cr&gt; WAVEFORM1:NAME:BYALIAS "Triangle" <b>[SOURCE:]WAVEFORM#:ALIAS?</b> Analogous to the WAVEFORM#[[:NAME]]? query command but in place of the waveform name, the alias is returned as a string. &lt;cr&gt; WAVEFORM1:ALIAS? Triangle</p>
<p>Command Syntax Description</p>	<p><b>[SOURCE:]WAVEFORM#:LOAD</b> Sets the waveform name (1 – 16) to be loaded for the selected phase # for the next SWITCH command. If # is omitted, sets all available phases to waveform name specified. Note: The waveform LOAD command loads the selected phase's waveform registers with the waveform data for the specified waveform name but does not cause it to appear at the output until the WAVEFORM:SWITCH command is received.</p>
<p>Parameters Parameter Format Example Query Format Returned Data Format Query Example</p>	<p>1 – 16 &lt;nr1&gt; WAVEFORM2:LOAD 12 <b>[SOURCE:]WAVEFORM#:LOAD?</b> &lt;nr1&gt; or &lt;nr1&gt;,&lt;nr1&gt;,nr1&gt; WAVEFORM:LOAD? 1,12,1</p>



---

Command Syntax	<b>[SOURCE:]WAVEFORM#:SWITCH</b>
Description	When sent for the selected phase, the output waveform is switched over to the new waveform name that was last set with the WAVEFORM#:LOAD command. . If # is omitted, sets all available phases' waveforms are switched.
Parameters	None other than phase selected in command string
Parameter Format	n/a
Example	WAVEFORM1:SWITCH

### 8.7.8 Voltage Protection Programming Commands

Note: For all protect Note: For all protection commands, # = Phase 1, 2 or 3 select or omit for all phases.

Command Syntax	<b>[SOURCE:]PROTECT:PEAK:VOLTage#:STATe</b>
Description	This command enables or disables the peak voltage protection.
Parameters	< 0   OFF   1 } ON >
Parameter Format	<b>
Example	PROT:PEAK:VOLT1:STAT 1
Query Format	<b>[SOURCE:]PROTECT:PEAK:VOLTage#:STATe?</b>
Returned Data Format	<nr1>
Query Example	PROT:PEAK:VOLT1:STAT? 1
Command Syntax	<b>[SOURCE:]PROTECT:PEAK:VOLTage:MODE &lt;MARGIn   LEVel   BOTH&gt;</b>
Description	This command sets the maximum voltage peak margin. If the output voltage peak exceeds the programmed peak level by more than this amount, an error is tripped.
Parameters	<MARGIn   0   LEVel   1   BOTH   2 >
	Encoding:
	MARGIn            0            Relative level
	LEVel             1            Absolute level
	BOTH              2            Both
Parameter Format	<cr>   <nr1>
Example	PROT:PEAK:VOLT:MODE BOTH
Query Format	<b>[SOURCE:]PROTECT:PEAK:VOLTage:MODE?</b>
Returned Data Format	<nr2>
Query Example	PROT:PEAK:VOLT:MODE? 2
Command Syntax	<b>[SOURCE:]PROTECT:PEAK:VOLTage:MARGIn &lt;VOLTAGE MARGIn&gt;</b>
Description	This command sets the maximum voltage peak margin. If the output voltage peak exceeds the programmed peak margin by more than this amount, an error is tripped.
Parameters	<VOLTAGE MARGIn>
Parameter Format	<nr2>
Example	PROT:PEAK:VOLT:MARG 120.0
Query Format	<b>[SOURCE:]PROTECT:PEAK:VOLTage:MARGIn?</b>
Returned Data Format	<nr2>
Query Example	PROT:PEAK:VOLT:MARG? 120.000
Query Syntax	<b>[SOURCE:]PROTECT:PEAK:VOLTage:MARGIn:MINimum?</b>
Description	This command returns the minimum voltage peak margin setting.
Query Example	PROT:PEAK:VOLT:MARG:MIN? 0.000

Query Syntax	<b>[SOURCE:]PROTECT:PEAK:VOLTage:MARGin:MAXimum?</b>
Description	This command returns the maximum voltage peak margin setting
Query Example	PROT:PEAK:VOLT:MARG:MAX? 500.000
Query Syntax	<b>[SOURCE:]PROTECT:PEAK:VOLTage:MARGin:DEFault?</b>
Description	This command returns the default voltage peak margin setting
Query Example	PROT:PEAK:VOLT:MARG:DEF? 100.000
Command Syntax	<b>[SOURCE:]PROTECT:PEAK:VOLTage:LEVel &lt;VOLTAGE LEVEL&gt;</b>
Description	This command sets the maximum voltage peak level. If the output voltage peak exceeds the programmed peak level by more than this amount, an error is tripped.
Parameters	<VOLTAGE LEVEL>
Parameter Format	<nr2>
Example	PROT:PEAK:VOLT:LEV 120.0
Query Format	<b>[SOURCE:]PROTECT:PEAK:VOLTage:LEVel?</b>
Returned Data Format	<nr2>
Query Example	PROT:PEAK:VOLT:LEV? 500.000
Query Syntax	<b>[SOURCE:]PROTECT:PEAK:VOLTage:LEVel:MINimum?</b>
Description	This command returns the minimum voltage peak level setting.
Query Example	PROT:PEAK:VOLT:LEV:MIN? 0.000
Query Syntax	<b>[SOURCE:]PROTECT:PEAK:VOLTage:LEVel:MAXimum?</b>
Description	This command returns the maximum voltage peak level setting
Query Example	PROT:PEAK:VOLT:LEV:MAX? 500.000
Query Syntax	<b>[SOURCE:]PROTECT:PEAK:VOLTage:LEVel:DEFault?</b>
Description	This command returns the default voltage peak level setting
Query Example	PROT:PEAK:VOLT:LEV:DEF? 500.000
Query Syntax	<b>[SOURCE:]PROTECT:PEAK:VOLTage:TRIPped?</b>
Description	This command returns 1 if the voltage peak protection has been tripped or 0 if no trip occurred.
Query Example	PROT:PEAK:VOLT:TRIP? 0.000
Command Syntax	<b>[SOURCE:]PROTECT:PEAK:VOLTage:TRIPped:CLEar</b>

---

Description	This command clears the peak voltage protection trip status. Once cleared, the power source output can be re-enabled.
Parameters	<VOLTAGE LEVEL>
Parameter Format	<nr2>
Example	PROT:PEAK:VOLT:TRIP:CLE

Query Syntax  
Description  
Query Example

**[SOURce:]PROTect:ALL?**

This command returns protection setting values for all phases.

PROT:PEAK:ALL

```
0,10.00,24.00,0.00,0,10.00,24.00,0.00,0,10.00,24.00,0.00,0,10.00,24.00,0.00,0
,3.0000,3.0000,0.0000,3.0000,3.0000,0.0000,0,3.0000,3.0000,0.0000,3.0000,3
.0000,0.0000,0,3.0000,3.0000,0.0000,3.0000,3.0000,0.0000,0,3.0000,3.0000,0
.0000,3.0000,3.0000,0.0000,0,1000.000,1000.000,0.000,0,1000.000,1000.000,
0.000,0,1000.000,1000.000,0.000,0,1000.000,1000.000,0.000,0,0.000,1000.00
0,0.000,0,0.000,1000.000,0.000,0,0.000,1000.000,0.000,0,0.000,1000.000,0.0
00,0,1200.000,1200.000,0.000,0,1200.000,1200.000,0.000,0,1200.000,1200.0
00,0.000,0,1200.000,1200.000,0.000,0,0.000,1200.000,0.000,0,0.000,1200.00
0,0.000,0,0.000,1200.000,0.000,0,0.000,1200.000,0.000,5,1,5,1,5,1,0,0,10
00000,0,0,0.000,100000.000,-
100000.000,0,0,10000000,0,0,0.000,100000.000,-
100000.000,0,0,10000000,0,0,0.000,100000.000,-
100000.000,0,0,10000000,0,0,0.000,100000.000,-
100000.000,0,0,10000000,0,0,0.000,100000.000,-
100000.000,0,0,10000000,0,0,0.000,100000.000,-
100000.000,0,0,10000000,0,0,0.000,100000.000,-
100000.000,0,0,10000000,0,0,0.000,100000.000,-
100000.000,0,0,10000000,0,0,0.000,100000.000,-
100000.000,0,0,10000000,0,0,0.000,100000.000,-
100000.000,0,0,10000000,0,0,0.000,100000.000,-
100000.000,0,0,10000000,0,0,0.000,100000.000,-
100000.000,0,0,10000000,0,0,0.000,100000.000,-
100000.000,0,0,10000000,0,0,0.000,100000.000,-
100000.000,0,0,10000000,0,0,0.000,100000.000,-
100000.000,0,0,10000000,0,0,0.000,100000.000,-
100000.000,0,0,10000000,0,0,0.000,100000.000,-
100000.000,0,0,10000000,0,0,0.000,100000.000,-
100000.000,1,0,0,7,100.000,500.000,0.000,500.000,500.000,0.000,1,0,0,7,100
.000,500.000,0.000,500.000,500.000,0.000,1,0,0,7,100.000,500.000,0.000,500
.000,500.000,0.000,1,0,0,7,100.000,500.000,0.000,500.000,500.000,0.000,0,1,
2,40.000,40.000,1.000,36.000,40.000,1.000,0,1,2,40.000,40.000,1.000,36.000,
40.000,1.000,0,1,2,40.000,40.000,1.000,36.000,40.000,1.000,0,1,2,40.000,40.
000,1.000,36.000,40.000,1.000,0,6.000,6.000,0.000,0,6.000,6.000,0.000,0,6.0
00,6.000,0.000,0,6.000,6.000,0.000
```

<p>Command Syntax Description</p>	<p><b>[SOURce:]PROTeCt:RMS:VOLTage:LEVel &lt;VOLTAGE LEVEL&gt;</b> This command sets the RMS voltage protection level. RMS protections require several cycles so respond slower than Voltage peak protections. Protection delay can be set by the user in 100 msec increments, i.e.a delay of 5 means 500 msec (5x 100ms). See SENSe:FAULT command section below for more info.</p>
<p>Parameters Parameter Format Example Query Format Returned Data Format Query Example</p>	<p>&lt;VOLTAGE LEVEL&gt; &lt;nr2&gt; PROT:RMS:VOLT:LEV 120.0 <b>[SOURce:]PROTeCt:RMS:VOLTage:LEVel?</b> &lt;nr2&gt; PROT:RMS:VOLT:LEV? 500.000</p>
<p>Command Syntax Description</p>	<p><b>[SOURce:]PROTeCt:RMS:xx:STATe</b> This command. Selections for “xx” are”: A, A1, A2, A3, CURRent, CURRent1, CURRent2, CURRent3, kVA, KVA1, KVA2, KVA3, POWer, POWer1, POWer2, POWer3, SHUTDOWN, SHUTDOWN1, SHUTDOWN2, SHUTDOWN3, CONDItion:CATalog?, CONDItion:LEV MIN   MAX   DEF?</p>
<p>Parameters Parameter Format Example Query Format Returned Data Format Query Example</p>	<p>&lt;VOLTAGE LEVEL&gt; &lt;nr1&gt; PROT:RMS:VOLT:LEV 120.0 <b>[SOURce:]PROTeCt:RMS:xx:STATe?</b> &lt;nr1&gt; PROT:RMS:PROT:RMS:A:STAT? 0,0,0</p>
<p>Query Syntax Description</p>	<p><b>[SOURce:]PROTeCt:RMS:xx:INFO?</b> This command. Selections for “xx” are”: A, A1, A2, A3, B, B1, B2, B3, SHUTDOWN, SHUTDOWN1, SHUTDOWN2, SHUTDOWN3</p>
<p>Query Example</p>	<p>PROT:PEAK:VOLT:TRIP? 0.000</p>

Command Syntax	<b>[SOURCE:]PROTECT:TDELAY &lt;nr1&gt;</b>
Description	This command sets the protection trip delay time in 100 millisecond units, so 1 means 100ms, 2 means 200ms, and so on. It can be queried with <b>PROT:TDELAY?</b> .
Parameters	Delay in 100 msec increments
Parameter Format	<nr1>
Example	PROT:TDEL 5
Query Format	<b>[SOURCE:]PROTECT:TDELAY?</b>
Returned Data Format	<nr1>
Query Example	PROT:TDEL? 5

### 8.7.9 Voltage Sense Protection Commands

#### Introduction

The **SENSE:FAULT** is a fault based on the difference between the RMS voltage measurement and the RMS voltage setpoint programmed.

If the **ABS(VOLTAGE\_SETPOINT\_RMS – VOLTAGE\_MEASUREMENT\_RMS) > MAX(SENSE:FAULT:LEVEL:PERCENTAGE \* VOLTAGE\_SETPOINT\_RMS, SENSE:FAULT:LEVEL:MIN)** the fault trips and turns the output of the unit off.

The trip time is programmed with **PROT:TDELAY X** where X is in 100 milliseconds unit, so 1 means 100ms, 2 means 200ms, and so on. It can be queried with **PROT:TDELAY?**

As this is a RMS protection it will take at least 100ms to trip, it is not faster than that.

- **SENSE:FAULT:LEVEL:MIN** establishes the minimum difference it will compare in RMS voltage terms.
- **SENSE:FAULT:LEVEL:PERCENTAGE** establishes the difference in terms of a percentage of the programmed RMS setpoint.

The maximum is used to compare, this gives the possibility to program in percentage terms absolute terms, or both.

For example, at 108Vrms programmed, the **ABS(VOLTAGE\_SETPOINT\_RMS – VOLTAGE\_MEASUREMENT\_RMS)** should exceed 108Vrms to trip.

For faster voltage protection use **peak voltage protection** which is based on instantaneous values instead of RMS.

<p>Command Syntax Description</p>	<p><b>SENSe:FAULT:LEVel:MIN &lt;nr2&gt;</b></p> <p>This command sets the minimum sense voltage at which a voltage sense fault will trip the output. The protection trips if the following condition is fulfilled during a time equal to the protection trip time:  <math>ABS(VOLTAGE\_SETPOINT\_RMS - VOLTAGE\_MEASUREMENT\_RMS) &gt; MAX(SENSe:FAULT:LEVel:PERcentage * VOLTAGE\_SETPOINT\_RMS, SENSe:FAULT:LEVel:MIN)</math></p> <p>By default SENSe:FAULT:LEVel:PERcentage is 10% and SENSe:FAULT:LEVel:MIN is 25 volts.</p>
<p>Parameters Parameter Format Example Query Format Returned Data Format Query Example</p>	<p>&lt;VOLTAGE LEVEL&gt;</p> <p>&lt;nr2&gt;</p> <p>SENS:FAULT: LEV:MIN 120.0</p> <p><b>SENSe:FAULT:LEVel:MIN?</b></p> <p>&lt;nr2&gt;</p> <p>SENS:FAULT:LEV:MIN? 25.000</p>
<p>Command Syntax Description</p>	<p><b>SENSe:FAULT:LEVel:PERcentage &lt;nr2&gt;</b></p> <p>This command sets the sense voltage delta between programmed and actual senses voltage in percent of voltage range at which a voltage sense fault will trip the output. The protection trips if the following condition is fulfilled during a time equal to the protection trip time:  <math>ABS(VOLTAGE\_SETPOINT\_RMS - VOLTAGE\_MEASUREMENT\_RMS) &gt; MAX(SENSe:FAULT:LEVel:PERcentage * VOLTAGE\_SETPOINT\_RMS, SENSe:FAULT:LEVel:MIN)</math></p> <p>By default SENSe:FAULT:LEVel:PERcentage is 10% and SENSe:FAULT:LEVel:MIN is 25 volts.</p>
<p>Parameters Parameter Format Example Query Format Returned Data Format Query Example</p>	<p>&lt;VOLTAGE LEVEL&gt;</p> <p>&lt;nr2&gt;</p> <p>SENS:FAULT: LEV:PERC 10.0</p> <p><b>SENSe:FAULT:LEVel:PERC?</b></p> <p>&lt;nr2&gt;</p> <p>SENS:FAULT:LEV:PERC? 10.000</p>
<p>Command Syntax Description</p>	<p><b>SENSe:PATH &lt;b&gt;</b></p> <p>This command selects the source for metering and CSC mode as either internal (0) or external (1).</p>
<p>Parameters Parameter Format Example Query Format Returned Data Format Query Example</p>	<p>&lt; 0   1 &gt;</p> <p>&lt;b&gt;</p> <p>SENS:PATH 1</p> <p><b>SENSe:PATH?</b></p> <p>&lt;b&gt;</p> <p>SENS:PATH? 1</p>

### 8.7.10 Current Protection Programming Commands

Note: For all protection commands, # = Phase 1, 2 or 3 select or omit for all phases.



Command Syntax	<b>[SOURCE:]PROTECT[:RMS]:CURRENT[#:STATE] &lt;ON   OFF&gt;</b>
Description	This command enables or disables the rms current protection. If the protection is tripped the power source output is disabled.
Parameters	< ON   1   OFF   0 >
Parameter Format	<nr1>   <cr>
Example	PROTECT:CURRENT1 ON
Query Format	<b>[SOURCE:]PROTECT[:RMS]:CURRENT#[:STATE]?</b>
Returned Data Format	<nr2>
Query Example	PROTECT:CURRENT? 1
Command Syntax	<b>[SOURCE:]PROTECT[:RMS]:CURRENT#:LEVEL &lt;LEVEL&gt;</b>
Description	This command sets the rms current protection level.
Parameters	< LEVEL >
Parameter Format	<nr2>
Example	PROT:CURRE1:LEVEL 40.0
Query Format	<b>[SOURCE:]PROTECT[:RMS]:CURRENT#:LEVEL?</b>
Returned Data Format	<nr2>
Query Example	PROT:CURRE:LEV? 40.000
Query Syntax	<b>[SOURCE:]PROTECT[:RMS]:CURRENT:LEVEL:MINIMUM?</b>
Description	This command returns the minimum rms current protection level setting.
Query Example	PROT:CURRE:LEV:MIN? 0.000
Query Syntax	<b>[SOURCE:]PROTECT[:RMS]:CURRENT:LEVEL:MAXIMUM?</b>
Description	This command returns the maximum rms current protection level setting.
Query Example	PROT:CURRE:LEV:MAX? 41.667
Query Syntax	<b>[SOURCE:]PROTECT[:RMS]:CURRENT:LEVEL:DEFAULT?</b>
Description	This command returns the default rms current protection level setting. This value will be a function of the power source model.
Query Example	PROT:CURRE:LEV:DEF? 41.667

Command Syntax	<b>[SOURCE:]PROTECT[:RMS]:CURRENT#:TDELAY &lt;DELAY&gt;</b>
Description	This command sets the rms current protection trip delay in 100 msec increments, i.e. as setting of 5 means 500 msec.
Parameters	< DELAY >
Parameter Format	<nr1>
Example	PROTECT:CURRE:TDELAY 5
Query Format	<b>[SOURCE:]PROTECT[:RMS]:CURRENT#:TDELAY?</b>
Returned Data Format	<nr1>
Query Example	PROT:CURRE:LEV? 5
Query Syntax	<b>[SOURCE:]PROTECT[:RMS]:CURRENT:TDELAY:MINIMUM?</b>
Description	This command returns the minimum rms current protection trip delay setting.
Query Example	PROT:CURRE:TDELAY:MIN? 0
Query Syntax	<b>[SOURCE:]PROTECT[:RMS]:CURRENT:TDELAY:MAXIMUM?</b>
Description	This command returns the maximum rms current protection trip delay setting.
Query Example	PROT:CURRE:TDELAY:MAX? 3000
Query Syntax	<b>[SOURCE:]PROTECT[:RMS]:CURRENT:TDELAY:DEFAULT?</b>
Description	This command returns the default rms current protection trip delay setting.
Query Example	[SOURCE:]PROTECT[:RMS]:CURRENT:TDELAY:DEFAULT? 41.667
Query Syntax	<b>[SOURCE:]PROTECT[:RMS]:CURRENT:TRIPPED?</b>
Description	This command returns rms current protection trip status. Returns 1 if tripped or 0 if not.
Query Example	PROT:CURRE:TRIP? 41.667
Command Syntax	<b>[SOURCE:]PROTECT[:RMS]:CURRENT:TRIPPED:CLEAR</b>
Description	This command clears the rms current protection trip status. Once cleared, the power source output can be enabled.
Parameters	None
Parameter Format	n/a
Example	PROT:CURRE:TRIP:CLE

Command Syntax	<b>[SOURce:]PEAK:CURRent:LIMit &lt;nr2&gt;</b>
Description	This command set the user programmable peak current protection limit. (Not available in models with -413 Option).
Parameters	Peak current
Parameter Format	<nr2>
Example	PEAK:CURR:LIM 80.0
Query Format	<b>[SOURce:]PEAK:CURRent:LIMit?</b>
Returned Data Format	<nr2>
Query Example	PEAK:CURR? 80.0000
Query Syntax	<b>[SOURce:]PEAK:CURRent:LIMit:MAXIMUM?</b>
Description	This query command returns the maximum allowable setting for the user programmable peak current protection limit. (Not available in models with -413 Option).
Returned Data Format	<nr2>
Query Example	PEAK:CURR:LIM:MAX? 104.0000
Query Syntax	<b>[SOURce:]PEAK:CURRent:LIMit:MINIMUM?</b>
Description	This query command returns the minimum allowable setting for the user programmable peak current protection limit. (Not available in models with -413 Option).
Returned Data Format	<nr2>
Query Example	PEAK:CURR:LIM:MIN? 0.0000
Query Syntax	<b>[SOURce:]PEAK:CURRent:LIMit:DEFault?</b>
Description	This query command returns the default setting for the user programmable peak current protection limit. (Not available in models with -413 Option).
Returned Data Format	<nr2>
Query Example	PEAK:CURR:LIM:DEF? 104.0000
Command Syntax	<b>[SOURce:]PROTEct:PEAK:CURRent#[[:STATe]] &lt;ON   OFF&gt;</b>
Description	This command enables or disables the peak current protection function.
Parameters	< ON   1   OFF   0 >
Parameter Format	<cr>   <b>
Example	PROT:PEAK:CURR1 ON
Query Format	<b>[SOURce:]PROTEct:PEAK:CURRent#[[:STATe]]?</b>
Returned Data Format	<b>
Query Example	PROT:PEAK:CURR1? 1

Command Syntax	<b>[SOURCE:]PROTECT:PEAK:CURRENT#:LEVEL &lt;LEVEL&gt;</b>
Description	This command sets the peak current protection level.
Parameters	< LEVEL >
Parameter Format	<nr2>
Example	PROT:PEAK:CURR1:LEV 95.0
Query Format	<b>[SOURCE:]PROTECT:PEAK:CURRENT#:LEVEL?</b>
Returned Data Format	<b>
Query Example	PROT:PEAK:CURR1:LEV? 95.0000
Query Syntax	<b>[SOURCE:]PROTECT:PEAK:CURRENT:LEVEL:MAXIMUM?</b>
Description	This query command returns the maximum allowable setting for the peak current protection level.
Returned Data Format	<nr2>
Query Example	PROT:PEAK:CURR:LEV:MAX? 104.0000
Query Syntax	<b>[SOURCE:]PROTECT:PEAK:CURRENT:LEVEL:MINIMUM?</b>
Description	This query command returns the minimum allowable setting for the peak current protection level.
Returned Data Format	<nr2>
Query Example	PROT:PEAK:CURR:LEV:MIN? 104.0000
Query Syntax	<b>[SOURCE:]PROTECT:PEAK:CURRENT:LEVEL:DEFAULT?</b>
Description	This query command returns the default setting for the peak current protection level.
Returned Data Format	<nr2>
Query Example	PROT:PEAK:CURR:LEV:DEF? 104.0000
Query Syntax	<b>[SOURCE:]PROTECT:PEAK:CURRENT:TRIPPED?</b>
Description	This query command returns tripped state of the peak current protection level function. Return 1 if tripped, 0 if not.
Returned Data Format	<b>
Query Example	PROT:PEAK:CURR:TRIP? 1
Command Syntax	<b>[SOURCE:]PROTECT:PEAK:CURRENT:TRIPPED:CLEAR</b>
Description	This command clears the peak current protection tripped status.
Parameters	None
Parameter Format	n/a
Example	PROT:PEAK:CURR:TRIP:CLE

### 8.7.11 Power Protection Programming Commands

Command Syntax	<b>[SOURCE:]POWER:LIMit#</b>
Description	This command sets the programmable true power limit level in kW for phase #. If # is omitted, all available phases are set to the value specified. The max available power for a phase can be obtained using the [SOURCE:]POWER:LIMit#:MAX? query command.
Parameters	Limit value in kW
Parameter Format	<nr2>
Example	POW:LIM 2.5
Query Format	<b>[SOURCE:]POWER:LIMit#?</b>
Returned Data Format	<nr2>
Query Example	POW:LIM1? 2.5000
Query Format	<b>[SOURCE:]POWER:LIMit#:MAX?</b>
Description	Returns maximum available true power capability for the specified phase # in kW. If # is omitted, returns maximum available power level for all phases. Typically, this value will be the same for all phases.
Returned Data Format	<nr2>
Query Example	POW:LIM1:MAX? 5.0000
Command Syntax	<b>[SOURCE:]KVA:LIMit#</b>
Description	This command sets the programmable apparent power limit level in kVA for phase #. If # is omitted, all available phases are set to the value specified. The max available apparent power for a phase can be obtained using the [SOURCE:]KVA:LIMit#:MAX? query command.
Parameters	Limit value in kVA
Parameter Format	<nr2>
Example	KVA:LIM 2.5
Query Format	<b>[SOURCE:]KVA:LIMit#?</b>
Returned Data Format	<nr2>
Query Example	POW:LIM1? 2.5000
Query Format	<b>[SOURCE:]KVA:LIMit#:MAX?</b>
Description	Returns maximum available apparent power capability for the specified phase # in kVA. If # is omitted, returns maximum available apparent power levels for all phases. Typically, this value will be the same for all phases.
Returned Data Format	<nr2>
Query Example	KVA:LIM1:MAX? 5.0000

Query Format Description	<p><b>[SOURce:]MODE#?</b> Returns protection mode for the selected phase # (# = 1, 2, or 3). If # is omitted, returns protection mode for all phases in comma separated format. Note: When the phase suffix is 1, 2 or 3 the possible return categories are from 0 to 4. With suffix is omitted, this command will return MIXED(5) if modes for each phase are not the same. For example, if in split phase mode phase A (suffix 1) is in VOLTAGE mode but phase B (suffix 2) is in CURRENT mode, the query SOUR:MODE? you will return MIXED: SOUR:MODE1? = VOLTAGE and SOUR:MODE2? = CURRENT -&gt; SOUR:MODE? = MIXED If both or phases are set to the same mode, the actual mode will be returned: SOUR:MODE1? = VOLTAGE and SOUR:MODE2? = VOLTAGE -&gt; SOUR:MODE? = VOLTAGE</p>
Returned Data Format	<p>&lt;cr&gt; Available protection modes: 0 = NONE 1 = VOLTAGE 2 = CURRENT 3 = POWER 4 = KVA 5 = MIXED</p>
Query Example	<p>SOUR:MODE? VOLTAGE, VOLTAGE, VOLTAGE</p>
Command Syntax Description Parameters Parameter Format Example Query Format Returned Data Format Query Example	<p><b>[SOURce:]PROTeCt[:RMS]:POWeR#[:STATe] &lt;ON OFF&gt;</b> This command turns the true power protection on or off. &lt; 0   OFF   1   ON &gt; &lt;b&gt;   &lt;cr&gt; PROT:POW ON <b>[SOURce:]PROTeCt[:RMS]:POWeR#[:STATe]?</b> &lt;b&gt; PROT:POW? 1</p>
Command Syntax Description Parameters Parameter Format Example Query Format Returned Data Format Query Example	<p><b>[SOURce:]PROTeCt[:RMS]:POWeR#:LEVeL &lt;LEVEL&gt;</b> This command sets the true power protection trip level. Setting is in KW. &lt; LEVEL &gt; &lt;nr2&gt; PROT:POW:LEV 5 <b>[SOURce:]PROTeCt[:RMS]:POWeR#:LEVeL?</b> &lt;b&gt; PROT:POW:LEV? 5.000</p>

Query Syntax	<b>[SOURCE:]PROTECT[:RMS]:POWER:LEVEL:MINimum?</b>
Description	This command returns the minimum true power protection level setting.
Query Example	PROT:POW:LEV:MIN? 0.000
Query Syntax	<b>[SOURCE:]PROTECT[:RMS]:POWER:LEVEL:MAXimum?</b>
Description	This command returns the maximum true power protection level setting.
Query Example	PROT:POW:LEV:MAX? 41.667
Query Syntax	<b>[SOURCE:]PROTECT[:RMS]:POWER:LEVEL:DEFAULT?</b>
Description	This command returns the default true power protection level setting. This value will be a function of the power source model.
Query Example	PROT:POW:LEV:DEF? 41.667
Command Syntax	<b>[SOURCE:]PROTECT[:RMS]:POWER#:TDELAY &lt;DELAY&gt;</b>
Description	This command sets the true power protection trip delay time. Setting is in multiples of 100 msec so 5 equals 500 msec.
Parameters	< LEVEL >
Parameter Format	<nr2>
Example	PROT:POW:LEV 5
Query Format	<b>[SOURCE:]PROTECT[:RMS]:POWER#:TDELAY?</b>
Returned Data Format	<b>
Query Example	PROT:POW:TDELAY? 5.000
Query Syntax	<b>[SOURCE:]PROTECT[:RMS]:POWER:TDELAY:MINimum?</b>
Description	This command returns the minimum true power protection trip delay time setting.
Query Example	PROT:POW: TDELAY:MIN? 0
Query Syntax	<b>[SOURCE:]PROTECT[:RMS]:POWER:TDELAY:MAXimum?</b>
Description	This command returns the maximum true power protection trip delay time setting.
Query Example	PROT:POW: TDELAY:MAX? 3000

Query Syntax	<b>[SOURCE:]PROTECT[:RMS]:POWER:TDELAY:DEFAULT?</b>
Description	This command returns the default true power protection trip delay time setting.
Query Example	PROT:POW:TDELAY:DEF? 5
Query Syntax	<b>[SOURCE:]PROTECT[:RMS]:POWER#:TRIPPED?</b>
Description	This command returns the true power protection trip status. Returns 1 if tripped or 0 if not.
Query Example	PROT:POW:TRIP? 41.667
Command Syntax	<b>[SOURCE:]PROTECT[:RMS]:POWER#:TRIPPED:CLEAR</b>
Description	This command clears the true power protection trip status. Once cleared, the power source output can be enabled.
Parameters	None
Parameter Format	n/a
Example	PROT:POW:TRIP:CLEAR
Command Syntax	<b>[SOURCE:]PROTECT[:RMS]:KVA#[:STATE] &lt;ON OFF&gt;</b>
Description	This command turns the apparent power protection on or off.
Parameters	< 0   OFF   1   ON >
Parameter Format	<b>   <cr>
Example	PROT:POW ON
Query Format	<b>[SOURCE:]PROTECT[:RMS]:KVA#[:STATE]?</b>
Returned Data Format	<b>
Query Example	PROT:KVA? 1
Command Syntax	<b>[SOURCE:]PROTECT[:RMS]:KVA#:LEVEL &lt;LEVEL&gt;</b>
Description	This command sets the apparent power protection trip level. Setting is in KW.
Parameters	< LEVEL >
Parameter Format	<nr2>
Example	PROT:POW:LEV 5
Query Format	<b>[SOURCE:]PROTECT[:RMS]:KVA#:LEVEL?</b>
Returned Data Format	<b>
Query Example	PROT:KVA:LEV? 5.000
Query Syntax	<b>[SOURCE:]PROTECT[:RMS]:KVA:LEVEL:MINIMUM?</b>
Description	This command returns the minimum apparent power protection level setting.
Query Example	PROT:KVA:LEV:MIN? 0.000



<p>Query Syntax Description</p> <p>Query Example</p>	<p><b>[SOURCE:]PROTECT[:RMS]:KVA:LEVEL:MAXIMUM?</b>          This command returns the maximum apparent power protection level setting.</p> <p>PROT:KVA:LEV:MAX?          41.667</p>
<p>Query Syntax Description</p> <p>Query Example</p>	<p><b>[SOURCE:]PROTECT[:RMS]:KVA:LEVEL:DEFAULT?</b>          This command returns the default apparent power protection level setting. This value will be a function of the power source model.</p> <p>PROT:KVA:LEV:DEF?          41.667</p>
<p>Command Syntax Description</p> <p>Parameters</p> <p>Parameter Format</p> <p>Example</p> <p>Query Format</p> <p>Returned Data Format</p> <p>Query Example</p>	<p><b>[SOURCE:]PROTECT[:RMS]:KVA#:TDELAY &lt;DELAY&gt;</b>          This command sets the apparent power protection trip delay time. Setting is in multiples of 100 msec so 5 equals 500 msec.</p> <p>&lt; LEVEL &gt;          &lt;nr2&gt;          PROT:KVA:LEV 5</p> <p><b>[SOURCE:]PROTECT[:RMS]:KVA#:TDELAY?</b>          &lt;b&gt;          PROT:KVA:TDELAY?          5.000</p>
<p>Query Syntax Description</p> <p>Query Example</p>	<p><b>[SOURCE:]PROTECT[:RMS]:KVA:TDELAY:MINIMUM?</b>          This command returns the minimum apparent power protection trip delay time setting.</p> <p>PROT:KVA: TDELAY:MIN?          0</p>
<p>Query Syntax Description</p> <p>Query Example</p>	<p><b>[SOURCE:]PROTECT[:RMS]:KVA:TDELAY:MAXIMUM?</b>          This command returns the maximum apparent power protection trip delay time setting.</p> <p>PROT:KVA: TDELAY:MAX?          3000</p>
<p>Query Syntax Description</p> <p>Query Example</p>	<p><b>[SOURCE:]PROTECT[:RMS]:KVA:TDELAY:DEFAULT?</b>          This command returns the default apparent power protection trip delay time setting.</p> <p>PROT:KVA:TDELAY:DEF?          5</p>
<p>Query Syntax Description</p> <p>Query Example</p>	<p><b>[SOURCE:]PROTECT[:RMS]:KVA#:TRIPPED?</b>          This command returns the apparent power protection trip status. Returns 1 if tripped or 0 if not.</p> <p>PROT:KVA:TRIP?          41.667</p>

Command Syntax	<b>[SOURCE:]PROTECT[:RMS]:KVA#:TRIPped:CLEar</b>
Description	This command clears the apparent power protection trip status. Once cleared, the power source output can be enabled.
Parameters	None
Parameter Format	n/a
Example	PROT:KVA:TRIP:CLE

### 8.7.1 Frequency Protection Programming Commands

Command Syntax	<b>[SOURCE:]PROTECT:RMS:UF#:LEVel &lt;FREQ LEVEL&gt;</b>
Description	This command sets the under-frequency level. If the output frequency drops below the programmed level, an error is tripped.
Parameters	<VOLTAGE LEVEL>
Parameter Format	<nr2>
Example	PROT:RMS:UF1:LEV 45.0
Query Format	<b>[SOURCE:]PROTECT:RMS:UF#:LEVel?</b>
Returned Data Format	<nr2>
Query Example	PROT:RMSUV:LEV? 45.000

Command Syntax	<b>[SOURCE:]PROTECT:RMS:UF#:STATE</b>
Description	This command sets the under frequency level. If the output frequency drops below the programmed level, an error is tripped.
Parameters	< 0   1 >
Parameter Format	<b>
Example	PROT:RMS:UV1:STAT 1
Query Format	<b>[SOURCE:]PROTECT:RMS:UF#:STATE?</b>
Returned Data Format	<nr1>
Query Example	PROT:RMS:UV1:STAT? 1

### 8.7.2 Impedance Programming Commands

These commands control the output impedance of the power source. The programmable output impedance is defined by a resistive component ( R ) and an inductive component ( L ).

**Note:** To enable the programmable impedance function, the output of the power source must be turned **OFF** first. Trying to enable this function while the output is ON will result in an error message.

Command Syntax	<b>[SOURCE:]IMPEdance[:R]</b>
Description	This command sets the R value for the output impedance. Available programming range depends on the mode (Real-time or RMS).
Parameters	<R>
Parameter Format	<nr2>
Example	IMPED 0.2
Query Format	<b>[SOURCE:]IMPEdance[:R]?</b>
Returned Data Format	<nr2>
Query Example	IMPED:R? 0.200
Query Syntax	<b>[SOURCE:]IMPEdance[:R][:LIMit]:MAXimum?</b>
Description	This command return the maximum allowable setting value for the R component of the output impedance.
Parameters	None
Parameter Format	N/A
Query Example	IMPED:R:MAX? 1.000
Query Syntax	<b>[SOURCE:]IMPEdance[:R][:LIMit]:MINimum?</b>
Description	This command return the minimum allowable setting value for the R component of the output impedance.
Parameters	None
Parameter Format	N/A
Query Example	IMPED:R:MIN? -1.000
Command Syntax	<b>[SOURCE:]IMPEdance:L</b>
Description	This command sets the L value for the output impedance. Available programming range is -0.00000000 ~ 0.00005000 (Henry).
Parameters	<L>
Parameter Format	<nr2>
Example	IMPED:L 0.00002
Query Format	<b>[SOURCE:]IMPEdance:L?</b>
Returned Data Format	<nr2>
Query Example	IMPED:L? 0.00002

Query Syntax Description	<b>[SOURCE:]IMPEdance:L[:LIMit]:MAXimum?</b> This command return the maximum allowable setting value for the L component of the output impedance.
Parameters Parameter Format Query Example	None N/A IMPED:L:MAX? 0.00005000
Query Syntax Description	<b>[SOURCE:]IMPEdance:L[:LIMit]:MINimum?</b> This command return the minimum allowable setting value for the L component of the output impedance.
Parameters Parameter Format Query Example	None N/A IMPED:L:MIN? 0.00000000
Command Syntax Description	<b>[SOURCE:]IMPEdance:MODE</b> This command sets the programmable impedance mode to either Real-Time mode (0) or RMS Mode (1). See page 155 for a description of both impedance modes. <ul style="list-style-type: none"> <li>0 Real mode.</li> <li>1 RMS mode.</li> </ul> <b>Note:</b> To change programmable impedance modes, the output of the power source must be turned <b>OFF</b> first. Trying to change modes while the output is ON will result in an error message.
Parameters Parameter Format Example Query Format Returned Data Format Query Example	< 0   1 > <b> IMPED:MODE 1 <b>[SOURCE:]IMPEdance:MODE?</b> <b> IMPED:MODE? 1

---

Command Syntax	<b>[SOURCE:]IMPEdance:STATe</b>
Description	This command sets the programmable impedance state to either Off (0) or On (1). <b>Note:</b> To enable the programmable impedance function, the output of the power source must be turned <b>OFF</b> first. Trying to enable this function while the output is ON will result in an error message.
Parameters	< 0   1 >
Parameter Format	<b>
Example	IMPED:STAT 1
Query Format	<b>[SOURCE:]IMPEdance:STATe?</b>
Returned Data Format	<b>
Query Example	IMPED:STAT? 1

### 8.7.3 STEP Transient Commands

The command in this section control STEP transients. Some of these commands have the option to specify NORmal or SATurate.

- SATurate mode:** If a dwell time setting is out of limits, the dwell time will saturate to the limit min/max and it will not trip an error.
- NORmal mode:** If a dwell time setting is out of limits, an error will be generated and the dwell time setting will not be modified.

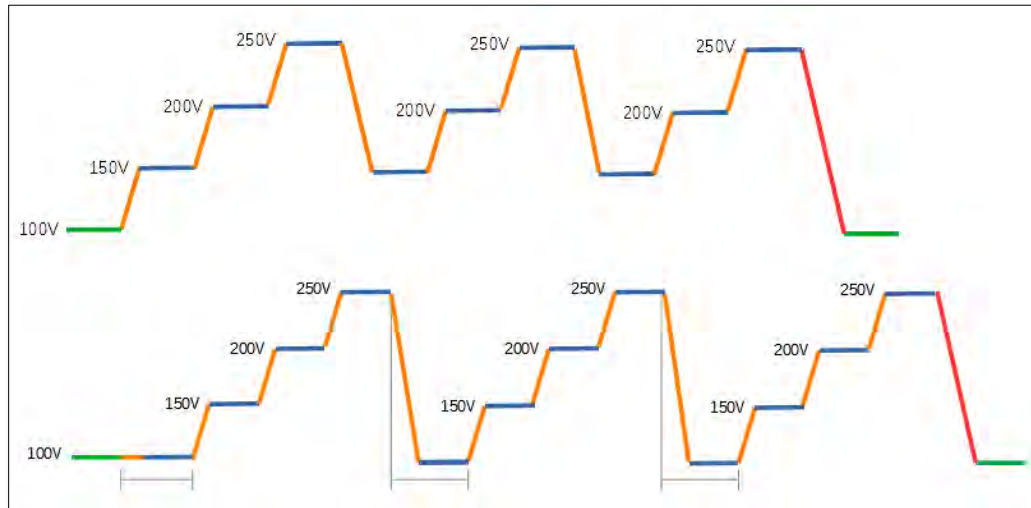
Command Syntax	<b>[SOURce:]STEP:MODE &lt; INIDEL   0   FINDEL   1   INIFIN   2 &gt;</b>
Description	This command sets the programming mode for a STEP Transient. 0   INIDEL Allows programming the step by initial and delta values 1   FINDEL Allows programming the step by final and delta values 2   INIFIN Allows programming the step by initial and final values
Parameters	< INIDEL   0   FINDEL   1   INIFIN   2 >
Parameter Format	<cr> or <nr1>
Example	STEP:MODE 1
Query Format	<b>[SOURce:]STEP:MODE?</b>
Returned Data Format	<nr1>
Query Example	STEP:MODE? 1

Query Syntax	<b>[SOURce:]STEP:MODE:CATalog?</b>
Description	This command returns the available mode settings for a STEP Transient. 0   INIDEL Allows programming the step by initial and delta values 1   FINDEL Allows programming the step by final and delta values 2   INIFIN Allows programming the step by initial and final values
Returned Data Format	<nr1>
Query Example	STEP:MODE:CAT? 0,Initial and delta,1,Final and delta,2,Initial and final

Command Syntax	<b>[SOURce:]STEP:INITialvalue &lt;OFF 0 ON 1&gt;</b>
Description	This command determines if an initial value step is inserted at the beginning of each repeat of a step transient. 0   ON Allows programming the step by initial and delta values 1   OFF Allows programming the step by final and delta values
Parameters	< OFF   0   ON   1 >
Parameter Format	<cr> or <nr1>
Example	STEP:INIT ON
Query Format	<b>[SOURce:]STEP:INITialvalue?</b>
Returned Data Format	<b>
Query Example	STEP:INIT? 1

The impact of inserting the initial value (ON) or not (OFF) is illustrated in the figure below.

- The top sequence shows a STEP transient repeated 3 times with STEP:INIT set to OFF. The output will not return to the initial output setting between repetitions.
- The bottom sequence is the same STEP transient with STEP:INIT set to ON. Each repeat will start from the initial set value so each repetition produces the same output levels.



Command Syntax  
Description

**[SOURCE:]STEP:DWELL <time>, <opt>**

This command sets the dwell time of the step in seconds  
Minimum time set value allowed is 0.0001 sec. (0.1 msec)  
Time in seconds, Option: < NORMAL | SATurate >  
Default is NORMAL if optional second parameter is omitted.

Parameters

Parameter Format

<nr2>, <cr>

Example

STEP:MODE:DWELL 10, SAT

Query Format

**[SOURCE:]STEP:MODE?**

Returned Data Format

<nr2>

Query Example

STEP:MODE:DWELL?  
10.0000, SAT

Query Syntax  
Description

**[SOURCE:]STEP:DWELL:MINimum?**

This command returns lowest permissible set value for the STEP dwell time setting.

Returned Data Format

<nr2>

Query Example

STEP:DWELL:MIN?

Query return values for MINimum, MAXimum and DEFault are dependent on MODE and interdependent parameter value settings

<p>Query Syntax Description</p> <p>Returned Data Format Query Example</p>	<p><b>[SOURCE:]STEP:DWELL:MAXimum?</b> This command returns highest permissible set value for the STEP dwell time setting.</p> <p>&lt;nr2&gt; STEP:DWELL:MAX? Query return values for MINimum, MAXimum and DEFault are dependent on MODE and interdependent parameter value settings</p>
<p>Query Syntax Description</p> <p>Returned Data Format Query Example</p>	<p><b>[SOURCE:]STEP:DWELL:DEFault?</b> This command returns default set value for the STEP dwell time setting.</p> <p>&lt;nr2&gt; STEP:DWELL:DEF? 0.0998</p>
<p>Command Syntax Description</p> <p>Parameters</p> <p>Parameter Format Example Query Format Returned Data Format Query Example</p>	<p><b>[SOURCE:]STEP:RAMP &lt;time&gt;, &lt;opt&gt;</b> This command sets the ramp time of the step in seconds Minimum time set value allowed is 0.0001 sec. (0.1 msec) Time in seconds, Option: &lt; NORmal   SATurate &gt; Default is NORmal if optional second parameter is omitted.</p> <p>&lt;nr2&gt;, &lt;cr&gt; STEP:MODE:RAMP 5, SAT <b>[SOURCE:]STEP:RAMP?</b> &lt;nr2&gt; STEP:RAMP? 5.0000, SAT</p>
<p>Query Syntax Description</p> <p>Returned Data Format Query Example</p>	<p><b>[SOURCE:]STEP:RAMP:MINimum?</b> This command returns lowest permissible set value for the STEP ramp time setting.</p> <p>&lt;nr2&gt; STEP:RAMP:MIN? Query return values for MINimum, MAXimum and DEFault are dependent on MODE and interdependent parameter value settings</p>
<p>Query Syntax Description</p> <p>Returned Data Format Query Example</p>	<p><b>[SOURCE:]STEP:RAMP:MAXimum?</b> This command returns highest permissible set value for the STEP ramp time setting.</p> <p>&lt;nr2&gt; STEP:RAMP:MAX? Query return values for MINimum, MAXimum and DEFault are dependent on MODE and interdependent parameter value settings</p>



<p>Query Syntax Description</p> <p>Returned Data Format Query Example</p>	<p><b>[SOURCE:]STEP:RAMP:DEFAULT?</b> This command returns default set value for the STEP ramp time setting.</p> <p>&lt;nr2&gt; STEP:RAMP:DEF? Query return values for MINimum, MAXimum and DEFault are dependent on MODE and interdependent parameter value settings</p>
<p>Command Syntax Description</p> <p>Parameters</p> <p>Parameter Format Example Query Format Returned Data Format Query Example</p>	<p><b>[SOURCE:]STEP:LENGTH &lt;time&gt;, &lt;opt&gt;</b> This command sets the ramp time of the step in seconds Minimum time set value allowed is 0.0001 sec. (0.1 msec) Time in seconds, Option: &lt; NORMAL   SATurate &gt; Default is NORMAL if optional second parameter is omitted.</p> <p>&lt;nr2&gt;, &lt;cr&gt; STEP:MODE:LENG 5, SAT <b>[SOURCE:]STEP:LENGTH?</b> &lt;nr2&gt; STEP:LENG? 5.0000, SAT</p>
<p>Query Syntax Description</p> <p>Returned Data Format Query Example</p>	<p><b>[SOURCE:]STEP:LENGTH:MINIMUM?</b> This command returns lowest permissible set value for the STEP length time setting.</p> <p>&lt;nr2&gt; STEP:LENG:MIN? Query return values for MINimum, MAXimum and DEFault are dependent on MODE and interdependent parameter value settings</p>
<p>Query Syntax Description</p> <p>Returned Data Format Query Example</p>	<p><b>[SOURCE:]STEP:LENGTH:MAXIMUM?</b> This command returns highest permissible set value for the STEP length time setting.</p> <p>&lt;nr2&gt; STEP:LENG:MAX? Query return values for MINimum, MAXimum and DEFault are dependent on MODE and interdependent parameter value settings</p>
<p>Query Syntax Description</p> <p>Returned Data Format Query Example</p>	<p><b>[SOURCE:]STEP:LENGTH:DEFAULT?</b> This command returns default set value for the STEP length time setting.</p> <p>&lt;nr2&gt; STEP:LENG:DEF? Query return values for MINimum, MAXimum and DEFault are dependent on MODE and interdependent parameter value settings</p>

Command Syntax	<b>[SOURCE:]STEP:REPeat &lt;no, opt&gt;</b>
Description	This command sets the number of repeat times for the ramp of the step
Parameters	No of repeats, Option: < NORmal   SATurate > Default is NORmal if optional second parameter is omitted.
Parameter Format	<nr1>, <cr>
Example	STEP:MODE:REP 100
Query Format	<b>[SOURCE:]STEP:REP?</b>
Returned Data Format	<nr2>
Query Example	STEP:REP? 100, NOR
Query Syntax	<b>[SOURCE:]STEP:REPeat:MINimum?</b>
Description	This command returns lowest permissible set value for the STEP length time setting.
Returned Data Format	<nr1>
Query Example	STEP:REP:MIN? 0
Query Syntax	<b>[SOURCE:]STEP:REPeat:MAXimum?</b>
Description	This command returns highest permissible set value for the STEP length time setting.
Returned Data Format	<nr1>
Query Example	STEP:REP:MAX? 65535
Query Syntax	<b>[SOURCE:]STEP:REPeat:DEFault?</b>
Description	This command returns default set value for the STEP length time setting.
Returned Data Format	<nr2>
Query Example	STEP:REP:DEF? 1
Command Syntax	<b>[SOURCE:]STEP:COUNT &lt;no, opt&gt;</b>
Description	This command sets the number of steps count.
Parameters	No of step count, Option: < NORmal   SATurate > Default is NORmal if optional second parameter is omitted.
Parameter Format	<nr1>, <cr>
Example	STEP:MODE:REP 12
Query Format	<b>[SOURCE:]STEP:COUNT?</b>
Returned Data Format	<nr2>
Query Example	STEP:REP? 12, NOR

Query Syntax	<b>[SOURCE:]STEP:COUNT:MINimum?</b>
Description	This command returns lowest permissible set value for the STEP count setting.
Returned Data Format	<nr1>
Query Example	STEP:COUNT:MIN? 1
Query Syntax	<b>[SOURCE:]STEP:COUNT:MAXimum?</b>
Description	This command returns highest permissible set value for the STEP count setting.
Returned Data Format	<nr1>
Query Example	STEP:COUNT:MAX? 200
Query Syntax	<b>[SOURCE:]STEP:COUNT:DEFault?</b>
Description	This command returns default set value for the STEP count setting.
Returned Data Format	<nr2>
Query Example	STEP:COUNT:DEF? 10
Command Syntax	<b>[SOURCE:]STEP:HOLD &lt; 0   OFF 1   ON &gt;</b>
Description	This command determines what happens to the source output after the step transient finishes. If ON, the last step value will be set as the steady state output when the step execution ends. If OFF, the output will revert to the original steady state setting in effect before the step transient execution.
Parameters	< 0   OFF   1   ON >
Parameter Format	<cr>
Example	STEP:HOLD ON
Query Format	<b>[SOURCE:]STEP:HOLD?</b>
Returned Data Format	<b>
Query Example	STEP:HOLD? 1

Command Syntax	<b>[SOURCE:]STEP:VOLTage[:AC][:INITial]# &lt; nr2 &gt;, &lt;cr&gt; [SOURCE:]STEP:VOLTage[:AC][:INITial]#</b>
Description	<b>Voltage phase A, OPT: Voltage phase B, OPT: Voltage phase C, OPT</b> This command sets the initial STEP voltage for selected phase # or for all phases if phase reference is omitted. Note: If you get the following error, check the STEP:MODE setting as the parameter you are trying to program is the depending one. <b>Execution error: Not allowed command with the current configuration.</b> Either set one of the othe STEP parameters or change the MODE. Note: If you get this error, check the min or max range for this parameter. <b>Parameter above maximum unit scope.</b>
Parameters	Voltage , < NORMal   SATurate > Default is NORMal if optional second parameter is omitted.
Parameter Format	<nr2>, <cr>
Example	STEP:VOLT1 230.00, SAT
Query Format	<b>[SOURCE:]STEP:VOLTage[:AC][:INITial]#?</b>
Returned Data Format	<nr2>   <nr2>,<nr2>,<nr2>
Query Example	STEP:VOLT1? 230.0000
Query Syntax	<b>[SOURCE:]STEP:VOLTage[:AC][:INITial]#:MINimum?</b>
Description	This command returns the minimum permissible set value for the initial STEP voltage for selected phase # or for all phases if phase reference is omitted
Returned Data Format	<nr2>
Query Example	STEP:VOLT1:MIN? Query return values for MINimum, MAXimum and DEFault are dependent on MODE and interdependent parameter value settings
Query Syntax	<b>[SOURCE:]STEP:VOLTage[:AC][:INITial]#:MAXimum?</b>
Description	This command returns the maximum permissible set value for the initial STEP voltage for selected phase # or for all phases if phase reference is omitted
Returned Data Format	<nr2>
Query Example	STEP:VOLT1:MAX? Query return values for MINimum, MAXimum and DEFault are dependent on MODE and interdependent parameter value settings
Query Syntax	<b>[SOURCE:]STEP:VOLTage[:AC][:INITial]#:DEFault?</b>
Description	This command returns the default set value for the initial STEP voltage for selected phase # or for all phases if phase reference is omitted
Returned Data Format	<nr2>
Query Example	STEP:VOLT1:DEF? Query return values for MINimum, MAXimum and DEFault are dependent on MODE and interdependent parameter value settings

Command Syntax	<b>[SOURCE:]STEP:VOLTage[:AC]:FINal# &lt; nr2 &gt;, &lt;cr&gt;</b> <b>[SOURCE:]STEP:VOLTage[:AC]:FINal#</b>
Description	<b>Voltage phase A, OPT: Voltage phase B, OPT: Voltage phase C, OPT</b> This command sets the final STEP voltage for selected phase # or for all phases if phase reference is omitted.
Parameters	Voltage , < NORmal   SATurate > Default is NORmal if optional second parameter is omitted.
Parameter Format	<nr2>, <cr>
Example	STEP:VOLT:FIN 180.00, SAT
Query Format	<b>[SOURCE:]STEP:VOLTage[:AC]:FINal#?</b>
Returned Data Format	<nr2>   <nr2>,<nr2>,<nr2>
Query Example	STEP:VOLT:FIN? 180.000,180.000,180.000
Query Syntax	<b>[SOURCE:]STEP:VOLTage[:AC]:FINal#:MINimum?</b>
Description	This command returns the minimum permissible set value for the final STEP voltage for selected phase # or for all phases if phase reference is omitted
Returned Data Format	<nr2>
Query Example	STEP:VOLT:FIN1:MIN? Query return values for MINimum, MAXimum and DEFault are dependent on MODE and interdependent parameter value settings
Query Syntax	<b>[SOURCE:]STEP:VOLTage[:AC]:FINal#:MAXimum?</b>
Description	This command returns the maximum permissible set value for the final STEP voltage for selected phase # or for all phases if phase reference is omitted
Returned Data Format	<nr2>
Query Example	STEP:VOLT:FIN1:MAX? Query return values for MINimum, MAXimum and DEFault are dependent on MODE and interdependent parameter value settings
Query Syntax	<b>[SOURCE:]STEP:VOLTage[:AC]:FINal#:DEFault?</b>
Description	This command returns the default set value for the final STEP voltage for selected phase # or for all phases if phase reference is omitted
Returned Data Format	<nr2>
Query Example	STEP:VOLT:FIN1:DEF? Query return values for MINimum, MAXimum and DEFault are dependent on MODE and interdependent parameter value settings

Command Syntax	<b>[SOURCE:]STEP:VOLTage[:AC]:DELTA# &lt; nr2 &gt;, &lt;cr&gt;</b> <b>[SOURCE:]STEP:VOLTage[:AC]:DELTA#</b>
Description	<b>Voltage phase A, OPT: Voltage phase B, OPT: Voltage phase C, OPT</b> This command sets the delta STEP voltage for selected phase # or for all phases if phase reference is omitted.
Parameters	Voltage , < NORmal   SATurate > Default is NORmal if optional second parameter is omitted.
Parameter Format	<nr2>, <cr>
Example	STEP:VOLT:DELT1 10.00, SAT
Query Format	<b>[SOURCE:]STEP:VOLTage[:AC]:DELTA#?</b>
Returned Data Format	<nr2>   <nr2>,<nr2>,<nr2>
Query Example	STEP:VOLT:DELT? 10.000,10.000,10.000
Query Syntax	<b>[SOURCE:]STEP:VOLTage[:AC]:DELTA#:MINimum?</b>
Description	This command returns the minimum permissible set value for the delta STEP voltage for selected phase # or for all phases if phase reference is omitted
Returned Data Format	<nr2>
Query Example	STEP:VOLT:DELT1:MIN? Query return values for MINimum, MAXimum and DEFault are dependent on MODE and interdependent parameter value settings
Query Syntax	<b>[SOURCE:]STEP:VOLTage[:AC]:DELTA#:MAXimum?</b>
Description	This command returns the maximum permissible set value for the delta STEP voltage for selected phase # or for all phases if phase reference is omitted
Returned Data Format	<nr2>
Query Example	STEP:VOLT:DELT1:MAX? Query return values for MINimum, MAXimum and DEFault are dependent on MODE and interdependent parameter value settings
Query Syntax	<b>[SOURCE:]STEP:VOLTage[:AC]:DELTA#:DEFault?</b>
Description	This command returns the default set value for the delta STEP voltage for selected phase # or for all phases if phase reference is omitted
Returned Data Format	<nr2>
Query Example	STEP:VOLT:DELT1:DEF? Query return values for MINimum, MAXimum and DEFault are dependent on MODE and interdependent parameter value settings

Command Syntax	<b>[SOURCE:]STEP:FREQUENCY[:INITIAL] &lt;nr2 &gt;, &lt;cr&gt;</b>
Description	This command sets the initial STEP frequency.
Parameters	Frequency, < NORMAL   SATurate > Default is NORMAL if optional second parameter is omitted.
Parameter Format	<nr2>, <cr>
Example	STEP:FREQ 50.0, SAT
Query Format	<b>[SOURCE:]STEP:FREQUENCY[:INITIAL]?</b>
Returned Data Format	<nr2>
Query Example	STEP:FREQ? 50.0000
Query Syntax	<b>[SOURCE:]STEP:FREQUENCY[:INITIAL]:MINIMUM?</b>
Description	This command returns the minimum permissible set value for the initial STEP frequency.
Returned Data Format	<nr2>
Query Example	STEP:FREQ:MIN? Query return values for MINimum, MAXimum and DEFault are dependent on MODE and interdependent parameter value settings
Query Syntax	<b>[SOURCE:]STEP:FREQUENCY[:INITIAL]:MAXIMUM?</b>
Description	This command returns the maximum permissible set value for the initial STEP frequency.
Returned Data Format	<nr2>
Query Example	STEP:FREQ:MAX? Query return values for MINimum, MAXimum and DEFault are dependent on MODE and interdependent parameter value settings
Query Syntax	<b>[SOURCE:]STEP:FREQUENCY[:INITIAL]:DEFAULT?</b>
Description	This command returns the default set value for the initial STEP frequency.
Returned Data Format	<nr2>
Query Example	STEP:FREQ:DEF? Query return values for MINimum, MAXimum and DEFault are dependent on MODE and interdependent parameter value settings
Command Syntax	<b>[SOURCE:]STEP:FREQUENCY:FINAL &lt;nr2 &gt;, &lt;cr&gt;</b>
Description	This command sets the final STEP frequency.
Parameters	Frequency, < NORMAL   SATurate > Default is NORMAL if optional second parameter is omitted.
Parameter Format	<nr2>, <cr>
Example	STEP:FREQ:FIN 55.0, SAT
Query Format	<b>[SOURCE:]STEP:FREQUENCY:FINAL?</b>
Returned Data Format	<nr2>
Query Example	STEP:FREQ:FIN? 55.0000

Query Syntax	<b>[SOURCE:]STEP:FREQUENCY:FINAL:MINIMUM?</b>
Description	This command returns the minimum permissible set value for the final STEP frequency.
Returned Data Format	<nr2>
Query Example	STEP:FREQ:FIN:MIN? 15.0000
Query Syntax	<b>[SOURCE:]STEP:FREQUENCY:FINAL:MAXIMUM?</b>
Description	This command returns the maximum permissible set value for the final STEP frequency.
Returned Data Format	<nr2>
Query Example	STEP:FREQ:FIN:MAX? 1200.0000
Query Syntax	<b>[SOURCE:]STEP:FREQUENCY:FINAL:DEFAULT?</b>
Description	This command returns the default set value for the final STEP frequency.
Returned Data Format	<nr2>
Query Example	STEP:FREQ:FIN:DEF? 60.0000
Command Syntax	<b>[SOURCE:]STEP:FREQUENCY:DELTA &lt;nr2 &gt;, &lt;cr&gt;</b>
Description	This command sets the delta frequency.
Parameters	Frequency, < NORMAL   SATURATE > Default is NORMAL if optional second parameter is omitted.
Parameter Format	<nr2>, <cr>
Example	STEP:FREQ:DELT 5.0, SAT
Query Format	<b>[SOURCE:]STEP:FREQUENCY:DELTA?</b>
Returned Data Format	<nr2>
Query Example	STEP:FREQ:DELT? 5.0000
Query Syntax	<b>[SOURCE:]STEP:FREQUENCY:DELTA:MINIMUM?</b>
Description	This command returns the minimum permissible set value for the delta STEP frequency.
Returned Data Format	<nr2>
Query Example	STEP:FREQ:DELT:MIN? Query return values for MINimum, MAXimum and DEFault are dependent on MODE and interdependent parameter value settings



<p>Query Syntax Description</p> <p>Returned Data Format Query Example</p>	<p><b>[SOURCE:]STEP:FREQuency:DELTA:MAXimum?</b> This command returns the maximum permissible set value for the delta STEP frequency.</p> <p>&lt;nr2&gt; STEP:FREQ:DELT:MAX? Query return values for MINimum, MAXimum and DEFault are dependent on MODE and interdependent parameter value settings</p>
<p>Query Syntax Description</p> <p>Returned Data Format Query Example</p>	<p><b>[SOURCE:]STEP:FREQuency:DELTA:DEFault?</b> This command returns the default set value for the delta STEP frequency.</p> <p>&lt;nr2&gt; STEP:FREQ:DELT:DEF? Query return values for MINimum, MAXimum and DEFault are dependent on MODE and interdependent parameter value settings</p>
<p>Command Syntax Description</p> <p>Parameters Parameter Format Example Query Format Returned Data Format Query Example</p>	<p><b>[SOURCE:]STEP:WAVEFORM# &lt;nr1 &gt;</b> This command sets the selected waveform using the waveform number.</p> <p>Waveform number &lt;nr1&gt;, &lt;cr&gt; STEP:WAVEFORM 1</p> <p><b>[SOURCE:]STEP:WAVEFORM#?</b> &lt;nr1&gt; STEP:WAVEFORM#? 1.0000</p>
<p>Query Syntax Description</p> <p>Returned Data Format Query Example</p>	<p><b>[SOURCE:]STEP:WAVEFORM#:MINimum?</b> This command returns the minimum permissible set value for the STEP waveform.</p> <p>&lt;nr1&gt; STEP:WAVEFORM#:MIN? 1</p>
<p>Query Syntax Description</p> <p>Returned Data Format Query Example</p>	<p><b>[SOURCE:]STEP:WAVEFORM#:MAXimum?</b> This command returns the maximum permissible set value for the STEP waveform.</p> <p>&lt;nr1&gt; STEP:WAVEFORM#:MAX? 200</p>
<p>Query Syntax Description Returned Data Format Query Example</p>	<p><b>[SOURCE:]STEP:WAVEFORM:DEFault?</b> This command returns the default set value for the STEP waveform.</p> <p>&lt;nr1&gt; STEP:WAVEFORM:DEF? 1</p>

<p>Command Syntax Description</p> <p>Parameters</p> <p>Parameter Format Example</p> <p>Query Format</p> <p>Returned Data Format</p> <p>Query Example</p>	<p><b>[SOURCE:]STEP:PHASE[:INITIAL]# &lt; nr2 &gt;, &lt;cr&gt;</b> This command sets the initial STEP phase angle for selected phase # number. Only phase 1 (B) and 2 (C) are allowed.</p> <p>Phase No., &lt; NORmal   SATurate &gt; Default is NORmal if optional second parameter is omitted.</p> <p>&lt;nr1&gt;, &lt;cr&gt; STEP:PHAS1 245.0</p> <p><b>[SOURCE:]STEP:PHASE[:INITIAL]#?</b> &lt;nr1&gt;, &lt;cr&gt; STEP:PHAS1? 245.0000</p>
<p>Query Syntax Description</p> <p>Returned Data Format Query Example</p>	<p><b>[SOURCE:]STEP:PHASE[:INITIAL]#:MINimum?</b> This command returns the minimum permissible set value of the initial STEP phase angle for selected phase #</p> <p>&lt;nr1&gt; STEP:PHAS1:MIN? Query return values for MINimum, MAXimum and DEFault are dependent on MODE and interdependent parameter value settings</p>
<p>Query Syntax Description</p> <p>Returned Data Format Query Example</p>	<p><b>[SOURCE:]STEP:PHASE[:INITIAL]#:MAXimum?</b> This command returns the maximum permissible set value of the initial STEP phase angle for selected phase #</p> <p>&lt;nr1&gt; STEP:PHAS1:MAX? Query return values for MINimum, MAXimum and DEFault are dependent on MODE and interdependent parameter value settings</p>
<p>Query Syntax Description</p> <p>Returned Data Format Query Example</p>	<p><b>[SOURCE:]STEP:PHASE[:INITIAL]#:DEF?</b> This command returns the default set value of the initial STEP phase angle for selected phase #</p> <p>&lt;nr1&gt; Query return values for MINimum, MAXimum and DEFault are dependent on MODE and interdependent parameter value settings</p>
<p>Command Syntax Description</p> <p>Parameters</p> <p>Parameter Format Example</p> <p>Query Format</p> <p>Returned Data Format Query Example</p>	<p><b>[SOURCE:]STEP:PHASE:FINAL# &lt; nr2 &gt;, &lt;cr&gt;</b> This command sets the final STEP phase angle for selected phase # number. Only phase 1 (B) and 2 (C) are allowed.</p> <p>Phase No., &lt; NORmal   SATurate &gt; Default is NORmal if optional second parameter is omitted.</p> <p>&lt;nr2&gt;, &lt;cr&gt; STEP:PHAS:FIN1 240.0</p> <p><b>[SOURCE:]STEP:PHASE:FINAL#?</b> &lt;nr2&gt; STEP:PHAS:FIN1? 240.0000</p>

Query Syntax	<b>[SOURCE:]STEP:PHASE:FINal#:MINimum?</b>
Description	This command returns the minimum permissible set value of the final STEP phase angle for selected phase #
Returned Data Format	<nr1>
Query Example	STEP:PHAS:FIN1:MIN? Query return values for MINimum, MAXimum and DEFault are dependent on MODE and interdependent parameter value settings
Query Syntax	<b>[SOURCE:]STEP:PHASE:FINal#:MAXimum?</b>
Description	This command returns the maximum permissible set value of the final STEP phase angle for selected phase #
Returned Data Format	<nr1>
Query Example	STEP:PHAS:FIN1:MAX? Query return values for MINimum, MAXimum and DEFault are dependent on MODE and interdependent parameter value settings
Query Syntax	<b>[SOURCE:]STEP:PHASE:FINal#:DEF?</b>
Description	This command returns the default set value of the final STEP phase angle for selected phase #
Returned Data Format	<nr1>
Query Example	STEP:PHAS:FIN1:DEF? Query return values for MINimum, MAXimum and DEFault are dependent on MODE and interdependent parameter value settings
Command Syntax	<b>[SOURCE:]STEP:PHASE:DELTA# &lt; nr2 &gt;, &lt;cr&gt;</b>
Description	This command sets the delta STEP phase angle for selected phase # number. Only phase 1 (B) and 2 (C) are allowed.
Parameters	Phase No., < NORmal   SATurate > Default is NORmal if optional second parameter is omitted.
Parameter Format	<nr1>, <cr>
Example	STEP:PHAS:DELT1 240.0
Query Format	<b>[SOURCE:]STEP:PHASE:DELTA#?</b>
Returned Data Format	<nr1>
Query Example	STEP:PHAS:DELT1? 240.0000
Query Syntax	<b>[SOURCE:]STEP:PHASE:DELTA#:MINimum?</b>
Description	This command returns the minimum permissible set value of the delta STEP phase angle for selected phase #
Returned Data Format	<nr1>
Query Example	STEP:PHAS:DELT1:MIN? Query return values for MINimum, MAXimum and DEFault are dependent on MODE and interdependent parameter value settings

Query Syntax	<b>[SOURCE:]STEP:PHASE:DELTA#:MAXimum?</b>
Description	This command returns the maximum permissible set value of the delta STEP phase angle for selected phase #
Returned Data Format	<nr1>
Query Example	STEP:PHAS:DELTA1:MAX? Query return values for MINimum, MAXimum and DEFault are dependent on MODE and interdependent parameter value settings
Query Syntax	<b>[SOURCE:]STEP:PHASE:DELTA#:DEF?</b>
Description	This command returns the default set value of the delta STEP phase angle for selected phase #
Returned Data Format	<nr1>
Query Example	Query return values for MINimum, MAXimum and DEFault are dependent on MODE and interdependent parameter value settings
Command Syntax	<b>[SOURCE:]STEP &lt;cr&gt;</b> >>> <i>Alias for PROGRAM:TRANSient command.</i> <<<
Description	This command controls step transient execution
Parameters	< RUN   STOP   PAUSE   STEP   RESTart >
Parameter Format	<cr>
Example	STEP RUN
Query Format	<b>[SOURCE:]STEP?</b>
Description	Query format returns the step transient execution state as either RUN, STOP, PAUS, STEP or REST
Returned Data Format	<nr1> Return values represent running state as follows:
	0 Stopped
	1 Running
	2 Paused
	3 Stepping
	4 Waiting for trigger
Query Example	STEP? 1

Command Syntax	<b>[SOURCE:]STEP:LOAD</b>
Description	This command converts the step transient definition to the power source's regular transient segment format and loads it in the controller real-time memory for execution.
Parameters	None
Parameter Format	n/a
Example	STEP RUN
Query Format	<b>[SOURCE:]STEP:LOAD?</b>
Description	Query format returns a 1 if the step transient load operation was successful, otherwise returns 0.
Returned Data Format	<nr1> Return values represent: 0 Load Failed 1 Load completed
Query Example	STEP? 1
Query Syntax	<b>[SOURCE:]STEP:PROGRESS?</b>
Description	>>> <i>Alias for PROGRAM:TRANSIENT:PROGRESS command.</i> <<< This query command returns the status of the step being executed.
Parameters	None
Parameter Format	n/a
Description	Query returns the step transient execution state as either RUN, STOP, PAUS, STEP or REST
Returned Data Format	<cr> The response is a comma-separated value string representing: PROGRESS, CURRENT SEGMENT PROGRESS, CURRENT SEGMENT, CURRENT SEGMENT TIME, TOTAL TIME, TOTAL SEGMENTS, REPEAT TIME COUNTER
Query Example	STEP:PROG? 1, 45, 2, 1.2300, 2.0000, 4, 5
Query Syntax	<b>[SOURCE:]STEP:CHECK?</b>
Description	This query command returns the result of a check on the programmed step parameters to determine if they are ok to run.
Parameters	None
Parameter Format	n/a
Description	Query returns result of STEP parameters integrity check
Returned Data Format	<cr> The response is either OK or if not, a string containing the error.
Query Example	STEP:PROG? OK

Query Syntax	<b>[SOURce:]STEP:ALL?</b>
Description	This query command returns a comma-separated values string of the entire step parameters, settings, and limits. Each set value is preceded by a tag identifying the parameter. This same data structure is used for front panel display and by the web server. The advantage is that this commands returns all step related information using just one query command.
Parameters	None
Parameter Format	n/a
Description	Returns complete STEP setup as a comma separated value string.
Returned Data Format	<cr>
Query Example	STEP:ALL?
	form,3,loaded,0,status,0,progress,0,current element progress,0,current element,0,current element time,0,total time,0,total elements,0,repeat times,0,hold,1,init,1,mode,0,mode max,2,mode min,0,dwell,0,dwell max,10000,dwell min,0,ramp,0,ramp max,10000,ramp min,0,length,0,length max,10000,length min,0,repeat,1,repeat max,65535,repeat min,0,count,10,count max,200,count min,1,count min reason,0,count max reason,0,waveform all,1,waveform all exist,1,waveform a,1,waveform a exist,1,waveform b,1,waveform b exist,1,waveform c,1,waveform c exist,1,waveform max,200,waveform min,1,initial frequency,0.0000,initial frequency min,0.0000,initial frequency max,0.0000,initial frequency min reason,4,initial frequency max reason,4,initial voltage ac all,0.0000,initial voltage ac all max,0.0000,initial voltage ac all min,0.0000,initial voltage ac all max reason,4,initial voltage ac all min reason,4,initial voltage ac a,0.0000,initial voltage ac a max,0.0000,initial voltage ac a min,0.0000,initial voltage ac a max reason,4,initial voltage ac a min reason,4,initial voltage ac b,0.0000,initial voltage ac b max,0.0000,initial voltage ac b min,0.0000,initial voltage ac b max reason,4,initial voltage ac b min reason,4,initial voltage ac c,0.0000,initial voltage ac c max,0.0000,initial voltage ac c min,0.0000,initial voltage ac c max reason,4,initial voltage ac c min reason,4,initial voltage dc all,0.0000,initial voltage dc all max,425.0000,initial voltage dc all min,-425.0000,initial voltage dc all max reason,0,initial voltage dc all min reason,0,initial voltage dc a,0.0000,initial voltage dc a max,425.0000,initial voltage dc a min,-425.0000,initial voltage dc a max reason,0,initial voltage dc a min reason,0,initial voltage dc b,0.0000,initial voltage dc b max,425.0000,initial voltage dc b min,-425.0000,initial voltage dc b max reason,0,initial voltage dc b min reason,0,initial voltage dc c,0.0000,initial voltage dc c max,425.0000,initial voltage dc c min,-425.0000,initial voltage dc c max reason,0,initial voltage dc c min reason,0,initial phase b,120.0000,initial phase c,240.0000,initial phase max,99999.0000,initial phase min,-99999.0000,final frequency,0.0000,final frequency min,0.0000,final frequency max,0.0000,final frequency min reason,4,final frequency max reason,4,final voltage ac all,0.0000,final voltage ac all max,0.0000,final voltage ac all min,0.0000,final voltage ac all max reason,4,final voltage ac all min reason,4,final voltage ac a,0.0000,final voltage ac a max,0.0000,final voltage ac a min,0.0000,final voltage ac a max reason,4,final voltage ac a min reason,4,final voltage ac b,0.0000,final voltage ac b max,0.0000,final voltage ac b min,0.0000,final voltage ac b max reason,4,final voltage ac b min reason,4,final voltage ac c,0.0000,final voltage ac c max,0.0000,final voltage ac c min,0.0000,final voltage ac c max reason,4,final voltage ac c min reason,4,final voltage dc all,0.0000,final voltage dc all max,425.0000,final voltage dc all min,-425.0000,final voltage dc all max reason,0,final voltage dc all min reason,0,final voltage dc a,0.0000,final voltage dc a max,425.0000,final voltage dc a min,-425.0000,final voltage dc a max reason,0,final voltage dc a min reason,0,final voltage dc b,0.0000,final voltage dc b max,425.0000,final voltage dc b min,-425.0000,final voltage dc b max reason,0,final voltage dc b min reason,0,final voltage dc c,0.0000,final voltage dc c max,425.0000,final voltage dc c min,-425.0000,final voltage dc c max reason,0,final phase b,120.0000,final phase c,240.0000,final phase max,99999.0000,final phase min,-99999.0000,delta frequency,0.0000,delta frequency min,0.0000,delta frequency max,0.0000,delta frequency min reason,4,delta frequency max reason,4,delta voltage ac all,0.0000,delta voltage ac all max,0.0000,delta voltage ac all min,0.0000,delta voltage ac all max reason,4,delta voltage ac all min reason,4,delta voltage ac a,0.0000,delta voltage ac a max,0.0000,delta voltage ac a min,0.0000,delta voltage ac a max reason,4,delta voltage ac a min reason,4,delta voltage ac b,0.0000,delta voltage ac b max,0.0000,delta voltage ac b min,0.0000,delta voltage ac b max reason,4,delta voltage ac b min reason,4,delta voltage ac c,0.0000,delta voltage ac c max,0.0000,delta voltage ac c min,0.0000,delta voltage ac c max reason,4,delta voltage ac c min reason,4,delta voltage dc all,0.0000,delta voltage dc all max,42.5000,delta voltage dc all min,-42.5000,delta voltage dc all max reason,0,delta voltage dc all min reason,0,delta voltage dc a,0.0000,delta voltage dc a max,42.5000,delta voltage dc a min,-42.5000,delta voltage dc a max reason,0,delta voltage dc a min reason,0,delta voltage dc b,0.0000,delta voltage dc b max,42.5000,delta voltage dc b min,-42.5000,delta voltage dc b max reason,0,delta voltage dc b min reason,0,delta voltage dc c,0.0000,delta voltage dc c max,42.5000,delta voltage dc c min,-42.5000,delta voltage dc c max reason,0,delta voltage dc c min reason,0,delta phase b,0.0000,delta phase c,0.0000,delta phase max,99999.0000,delta phase min,-99999.0000

### 8.7.4 PULSE Transient Commands

The command in this section control PULSE transients. Some of these commands have the option to specify NORmal or SATurate.

**SATurate mode:** If a dwell time setting is out of limits, the dwell time will saturate to the limit min/max and it will not trip an error.

**NORmal mode:** If a dwell time setting is out of limits, an error will be generated and the dwell time setting will not be modified.

Command Syntax	<b>[SOURCE:]PULSE:COUNT &lt;nr1&gt;, &lt;opt&gt;</b>
Description	This command sets the pulse count or the number of pulses to execute. Minimum time set value allowed is 1.
Parameters	Count, Option: < NORmal   SATurate > Default is NORmal if optional second parameter is omitted.
Parameter Format	<nr1>, <cr>
Example	PULS:COUNT 5
Query Format	<b>[SOURCE:]PULSE:COUNT?</b>
Returned Data Format	<nr1>
Query Example	PULS:COUNT? 5.0000
Query Syntax	<b>[SOURCE:]PULSE:COUNT:MINimum?</b>
Description	This command returns the minimum permissible set value for the PULSE count.
Returned Data Format	<nr1>
Query Example	PULS:COUNT:MIN? 0
Query Syntax	<b>[SOURCE:]PULSE:COUNT:MAXimum?</b>
Description	This command returns the maximum permissible set value for the PULSE count.
Returned Data Format	<nr1>
Query Example	PULS:COUNT:MAX? 65535
Query Syntax	<b>[SOURCE:]PULSE:COUNT:DEFault?</b>
Description	This command returns the default set value for the PULSE count.
Returned Data Format	<nr1>
Query Example	PULS:COUNT:DEF? 1

Command Syntax	<b>[SOURCE:]PULSE:DCYCLE &lt;nr1&gt;, &lt;opt&gt;</b>
Description	This command sets the pulse duty cycle in percent. Minimum set value allowed is 1, max is 99.
Parameters	Duty Cycle %, Option: < NORmal   SATurate > Default is NORmal if optional second parameter is omitted.
Parameter Format	<nr1>, <cr>
Example	PULS:DCYC 50
Query Format	<b>[SOURCE:]PULSE:DCYCLE?</b>
Returned Data Format	<nr1>
Query Example	PULS:DCYC? 50.0000
Query Syntax	<b>[SOURCE:]PULSE:DCYCLE:MINimum?</b>
Description	This command returns the minimum permissible set value for the PULSE duty cycle.
Returned Data Format	<nr2>
Query Example	PULS:DCYC:MIN? 0.0000
Query Syntax	<b>[SOURCE:]PULSE:DCYCLE:MAXimum?</b>
Description	This command returns the maximum permissible set value for the PULSE duty cycle.
Returned Data Format	<nr2>
Query Example	PULS:DCYC:MAX? 100.0000
Query Syntax	<b>[SOURCE:]PULSE:DCYCLE:DEFault?</b>
Description	This command returns the default set value for the PULSE duty cycle.
Returned Data Format	<nr2>
Query Example	PULS:DCYC:DEF? 50.0000
Command Syntax	<b>[SOURCE:]PULSE:PERiod &lt;nr2&gt;, &lt;opt&gt;</b>
Description	This command sets the pulse period in seconds.
Parameters	Period, Option: < NORmal   SATurate > Default is NORmal if optional second parameter is omitted.
Parameter Format	<nr2>, <cr>
Example	PULS:PER 12.8
Query Format	<b>[SOURCE:]PULSE:PERiod?</b>
Returned Data Format	<nr2>
Query Example	PULS:PER? 12.8000



Query Syntax	<b>[SOURCE:]PULSE:PERIOD:MINIMUM?</b>
Description	This command returns the minimum permissible set value for the PULSE period setting.
Returned Data Format	<nr2>
Query Example	PULS:PER:MIN? Query return values for MINimum, MAXimum and DEFault are dependent on MODE and interdependent parameter value settings
Query Syntax	<b>[SOURCE:]PULSE:PERIOD:MAXIMUM?</b>
Description	This command returns the maximum permissible set value for the PULSE period.
Returned Data Format	<nr2>
Query Example	PULS:PER:MAX? Query return values for MINimum, MAXimum and DEFault are dependent on MODE and interdependent parameter value settings
Query Syntax	<b>[SOURCE:]PULSE:PERIOD:DEFAULT?</b>
Description	This command returns the default set value for the PULSE period.
Returned Data Format	<nr2>
Query Example	PULS:PER:DEF? Query return values for MINimum, MAXimum and DEFault are dependent on MODE and interdependent parameter value settings
Command Syntax	<b>[SOURCE:]PULSE:WIDTH &lt;nr2&gt;, &lt;opt&gt;</b>
Description	This command sets the pulse width in seconds.
Parameters	Width, Option: < NORMAL   SATurate > Default is NORMAL if optional second parameter is omitted.
Parameter Format	<nr2>, <cr>
Example	PULS:WIDT 25.6
Query Format	<b>[SOURCE:]PULSE:WIDTH?</b>
Returned Data Format	<nr2>
Query Example	PULS:WIDT? 25.6000
Query Syntax	<b>[SOURCE:]PULSE:WIDTH:MINIMUM?</b>
Description	This command returns the minimum permissible set value for the PULSE width.
Returned Data Format	<nr2>
Query Example	PULS:WIDT:MIN? Query return values for MINimum, MAXimum and DEFault are dependent on MODE and interdependent parameter value settings

Query Syntax	<b>[SOURCE:]PULSE:WIDTH:MAXimum?</b>
Description	This command the returns maximum permissible set value for the PULSE width.
Returned Data Format	<nr2>
Query Example	PULS:WIDT:MAX? Query return values for MINimum, MAXimum and DEFault are dependent on MODE and interdependent parameter value settings
Query Syntax	<b>[SOURCE:]PULSE:WIDTH:DEFault?</b>
Description	This command returns the default set value for the PULSE width.
Returned Data Format	<nr2>
Query Example	PULS:WIDT:DEF? Query return values for MINimum, MAXimum and DEFault are dependent on MODE and interdependent parameter value settings
Command Syntax	<b>[SOURCE:]PULSE:MODE &lt;nr2&gt;, &lt;opt&gt;</b>
Description	This command sets the pulse width in seconds.
Parameters	< 0   PW   1   PD   2   WD > Encoding: 0   PW program pulse by period and width 1   PD program pulse by period and duty cycle 2   WD program pulse by width and duty cycle
Parameter Format	<nr1> or <cr>
Example	PULS:MODE WD
Query Format	<b>[SOURCE:]PULSE:MODE?</b>
Returned Data Format	<nr1>
Query Example	PULS:MODE? 2
Query Syntax	<b>[SOURCE:]PULSE:MODE:CATalog?</b>
Description	This command returns the available programming modes: "0,Period and width,1,Period and duty cycle,2,Width and duty cycle".
Parameters	None
Returned Data Format	<cr>
Query Example	PULS:MODE:CAT? 0,Period and width,1,Period and duty cycle,2,Width and duty cycle
Command Syntax	<b>[SOURCE:]PULSE:RAMP &lt;nr2&gt;, &lt;opt&gt;</b>
Description	This command sets the pulse ramp time in seconds.
Parameters	Ramp time, Option: < NORmal   SATurate > Default is NORmal if optional second parameter is omitted.
Parameter Format	<nr2>, <cr>
Example	PULS:RAMP 0.2
Query Format	<b>[SOURCE:]PULSE:RAMP?</b>
Returned Data Format	<nr2>
Query Example	PULS:RAMP? 0.2

Query Syntax	<b>[SOURCE:]PULSE:RAMP:MINimum?</b>
Description	This command returns the minimum permissible set value for the PULSE ramp time.
Returned Data Format	<nr2>
Query Example	PULS:RAMP:MIN? Query return values for MINimum, MAXimum and DEFault are dependent on MODE and interdependent parameter value settings
Query Syntax	<b>[SOURCE:]PULSE:RAMP:MAXimum?</b>
Description	This command returns the maximum permissible set value for the PULSE ramp time.
Returned Data Format	<nr2>
Query Example	PULS:RAMP:MAX? Query return values for MINimum, MAXimum and DEFault are dependent on MODE and interdependent parameter value settings
Query Syntax	<b>[SOURCE:]PULSE:RAMP:DEFault?</b>
Description	This command returns the default setting for the PULSE ramp time.
Returned Data Format	<nr2>
Query Example	PULS:RAMP:DEF? Query return values for MINimum, MAXimum and DEFault are dependent on MODE and interdependent parameter value settings
Command Syntax	<b>[SOURCE:]PULSE:VOLTage[:AC]# &lt; nr2 &gt;, &lt;cr&gt;</b> <b>[SOURCE:]PULSE:VOLTage[:AC] #</b> <b>Voltage phase A, OPT: Voltage phase B, OPT: Voltage phase C, OPT</b>
Description	This command sets the PULSE voltage for selected phase # or for all phases if phase reference is omitted.
Parameters	Voltage , < NORmal   SATurate > Default is NORmal if optional second parameter is omitted.
Parameter Format	<nr2>, <cr>
Example	PULS:VOLT1 230.00, SAT
Query Format	<b>[SOURCE:]PULSE:VOLTage[:AC]#?</b>
Returned Data Format	<nr2>
Query Example	PULS:VOLT1? 230.0000
Query Syntax	<b>[SOURCE:]PULSE:VOLTage[:AC]#:MINimum?</b>
Description	This command returns the minimum permissible set value for the PULSE voltage for selected phase # or for all phases if phase reference is omitted
Returned Data Format	<nr2>
Query Example	PULS:VOLT1:MIN? 0.0000

<p>Query Syntax Description</p>	<p><b>[SOURce:]PULSe:VOLTage[:AC]#:MAXimum?</b> This command returns the maximum permissible set value for the PULSE voltage for selected phase # or for all phases if phase reference is omitted</p>
<p>Returned Data Format Query Example</p>	<p>&lt;nr2&gt; PULS:VOLT:MAX? 300.0000</p>
<p>Query Syntax Description</p>	<p><b>[SOURce:]PULSe:VOLTage[:AC]#:DEFault?</b> This command returns the default set value for the PULSE voltage for selected phase # or for all phases if phase reference is omitted</p>
<p>Returned Data Format Query Example</p>	<p>&lt;nr2&gt; PULS:VOLT:DEF? 0.000,0.000,0.000 PULS:VOLT1:DEF? 0.000</p>
<p>Command Syntax Description Parameters</p>	<p><b>[SOURce:]PULSe:FREQuency &lt; nr2 &gt;, &lt;cr&gt;</b> This command sets the PULSE frequency. Voltage , &lt; NORMal   SATurate &gt; Default is NORMal if optional second parameter is omitted.</p>
<p>Parameter Format Example Query Format Returned Data Format Query Example</p>	<p>&lt;nr2&gt;, &lt;cr&gt; PULS:FREQ 50.00 <b>[SOURce:]PULSe:FREQuency?</b> &lt;nr2&gt; PULS:FREQ? 60.0000</p>
<p>Query Syntax Description</p>	<p><b>[SOURce:]PULSe:FREQuency:MINimum?</b> This command returns the minimum permissible set value for the PULSE frequency.</p>
<p>Returned Data Format Query Example</p>	<p>&lt;nr2&gt; PULS:FREQ:MIN? 15.0000</p>
<p>Query Syntax Description</p>	<p><b>[SOURce:]PULSe:FREQuency:MAXimum?</b> This command returns the maximum permissible set value for the PULSE frequency.</p>
<p>Returned Data Format Query Example</p>	<p>&lt;nr2&gt; PULS:FREQ:MIN? 1200.0000</p>

Query Syntax	<b>[SOURCE:]PULSE:FREQUENCY:DEFAULT?</b>
Description	This command returns the default set value for the initial PULSE frequency.
Returned Data Format	<nr2>
Query Example	PULS:FREQ:DEF? 60.0000
Command Syntax	<b>[SOURCE:]PULSE:WAVEFORM# &lt;nr1 &gt;</b>
Description	This command sets the selected waveform using the waveform number.
Parameters	Waveform number
Parameter Format	<nr1>, <cr>
Example	PULS:WAVEFORM 1
Query Format	<b>[SOURCE:]PULSE:WAVEFORM#?</b>
Returned Data Format	<nr1>
Query Example	PULS:WAVEFORM#? 1.0000
Query Syntax	<b>[SOURCE:]PULSE:WAVEFORM#:MINIMUM?</b>
Description	This command returns the minimum permissible set value for the PULSE waveform.
Returned Data Format	<nr1>
Query Example	PULS:WAVEFORM#:MIN? 1
Query Syntax	<b>[SOURCE:]PULSE:WAVEFORM#:MAXIMUM?</b>
Description	This command returns the maximum permissible set value for the PULSE waveform.
Returned Data Format	<nr1>
Query Example	PULS:WAVEFORM#:MAX? 200
Query Syntax	<b>[SOURCE:]PULSE:WAVEFORM:DEFAULT?</b>
Description	This command returns the default set value for the PULSE waveform.
Returned Data Format	<nr1>
Query Example	PULS:WAVEFORM:DEF? 1

<p>Command Syntax Description</p> <p>Parameters</p> <p>Parameter Format Example</p> <p>Query Format Returned Data Format Query Example</p>	<p><b>[SOURCE:]PULSE:PHASE# &lt; nr2 &gt;, &lt;cr&gt;</b>          This command sets the initial PULSE phase angle for selected phase # number. Only phase 2 (B) and 3 (C) are allowed.</p> <p>Phase No., &lt; NORmal   SATurate &gt;          Default is NORmal if optional second parameter is omitted.</p> <p>&lt;nr1&gt;, &lt;cr&gt;          PULS:PHAS1 245.0</p> <p><b>[SOURCE:]PULSE:PHASE#?</b>          &lt;nr1&gt;, &lt;cr&gt;          PULS:PHAS1?          245.0000</p>
<p>Query Syntax Description</p> <p>Returned Data Format Query Example</p>	<p><b>[SOURCE:]PULSE:PHASE#:MINimum?</b>          This command returns the minimum permissible set value of the initial PULSE phase angle for selected phase #</p> <p>&lt;nr1&gt;          PULS:PHAS1:MIN?          0.0000</p>
<p>Query Syntax Description</p> <p>Returned Data Format Query Example</p>	<p><b>[SOURCE:]PULSE:PHASE#:MAXimum?</b>          This command returns the maximum permissible set value of the initial PULSE phase angle for selected phase #</p> <p>&lt;nr1&gt;          PULS:PHAS1:MAX?          360.000</p>
<p>Query Syntax Description</p> <p>Returned Data Format Query Example</p>	<p><b>[SOURCE:]PULSE:PHASE#:DEF?</b>          This command returns the default set value of the initial PULSE phase angle for selected phase #</p> <p>&lt;nr1&gt;          PULS:PHAS2:DEF?          120.0000          PULS:PHAS3:DEF?          240.0000</p>

Command Syntax	<b>[SOURce:]PULSe &lt;cr&gt;</b>
Description	>>> <i>Alias for PROGram:TRANSient command.</i> <<<
Parameters	< RUN   STOP   PAUSe   STEP   REStart >
Parameter Format	<cr>
Example	PULS RUN
Query Format	<b>[SOURce:]PULSe?</b>
Description	Query format returns the pulse transient execution state as either RUN, STOP, PAUS, STEP or REST
Returned Data Format	<nr1> Return values respresent running state as follows: 0 Stopped 1 Running 2 Paused 3 Stepping 4 Waiting for trigger
Query Example	PULS? 1
Command Syntax	<b>[SOURce:]PULSe:LOAD</b>
Description	This command converts the pulse transient definition to the power source's regular transient segment format and loads it in the controller real-time memory for execution.
Parameters	None
Parameter Format	n/a
Example	STEP RUN
Query Format	<b>[SOURce:]PULSe:LOAD?</b>
Description	Query format returns a 1 if the pulse transient load operation was successful, otherwise returns 0.
Returned Data Format	<nr1> Return values respresent: 0 Load Failed 1 Load completed
Query Example	STEP? 1

Query Syntax	<b>[SOURCE:]PULSE:PROGRESS?</b>
Description	>>> <i>Alias for PROGRAM:TRANSient:PROGRESS command.</i> <<<
Parameters	None
Parameter Format	n/a
Description	Query returns the step transient execution state as either RUN, STOP, PAUS, STEP or REST
Returned Data Format	<cr> The response is a comma-separated value string representing: PROGRESS, CURRENT SEGMENT PROGRESS, CURRENT SEGMENT, CURRENT SEGMENT TIME, TOTAL TIME, TOTAL SEGMENTS, REPEAT TIME COUNTER
Query Example	PULS:PROG? 1, 45, 2, 1.2300, 2.0000, 4, 5
Query Syntax	<b>[SOURCE:]PULSE:CHECK?</b>
Description	This query command returns the result of a check on the programmed pulse parameters to determine if they are ok to run.
Parameters	None
Parameter Format	n/a
Description	Query returns result of PULSE parameters integrity check
Returned Data Format	<cr> The response is either OK or if not, a string containing the error.
Query Example	PULS:PROG? OK
Query Syntax	<b>[SOURCE:]PULSE:ALL?</b>
Description	This query command returns a comma-separated values string of the entire pulse parameters, settings, and limits. Each set value is preceded by a tag identifying the parameter. This same data structure is used for front panel display and by the web server. The advantage is that this commands returns all pulse related information using just one query command.
Parameters	None
Parameter Format	n/a
Description	Returns complete PULSE setup as a comma separated value string.
Returned Data Format	<cr>
Query Example	PULS:ALL? form,3,loaded,0,status,0,progress,0,current element progress,0,current element,0,current element time,0,total time,0,total elements,0,repeat times,0,count,1,count max,65535,count min,0,dcycle,50.0000,dcycle max,100.0000,dcycle max,0.0000,period,0,period max,50000,period min,0,width,0,width max,50000,width min,0,ramp,0,ramp max,0,ramp min,0,mode,0,mode max,2,mode min,0,frequency,60.000,frequency min,15.000,frequency max,1200.000,frequency min reason,1,frequency max reason,2,waveform all,1,waveform all exist,1,waveform a,1,waveform a exist,1,waveform b,1,waveform b exist,1,waveform c,1,waveform c exist,1,waveform max,200,waveform min,1,voltage ac all,0.000,voltage ac all max,300.000,voltage ac all min,0.000,voltage ac all max reason,2,voltage ac all min reason,0,voltage ac a,0.000,voltage ac a max,300.000,voltage ac a



min,0.000,voltage ac a max reason,2,voltage ac a min reason,0,voltage ac b,0.000,voltage ac b max,300.000,voltage ac b min,0.000,voltage ac b max reason,2,voltage ac b min reason,0,voltage ac c,0.000,voltage ac c max,300.000,voltage ac c min,0.000,voltage ac c max reason,2,voltage ac c min reason,0,voltage dc all,0.000,voltage dc all max,425.000,voltage dc all min,-425.000,voltage dc all max reason,0,voltage dc all min reason,0,voltage dc a,0.000,voltage dc a max,425.000,voltage dc a min,-425.000,voltage dc a max reason,0,voltage dc a min reason,0,voltage dc b,0.000,voltage dc b max,425.000,voltage dc b min,-425.000,voltage dc b max reason,0,voltage dc b min reason,0,voltage dc c,0.000,voltage dc c max,425.000,voltage dc c min,-425.000,voltage dc c max reason,0,voltage dc c min reason,0,phase b,120.000,phase c,240.000,phase max,360.000,phase min,0.000

### 8.7.5 Interharmonics Commands (IEC61000-4-13 Option C)

The following SCPI commands are used to generate interharmonics on the output of the power source. These commands require the IEC413 option “C” to be configured on the unit. If configured, the \*IDN? model number response will have a “C” appended. You can also check the unit’s configuration using the SYSTem:FEATures? Command and look for the Interhamonics feature.

Command Syntax	<b>[SOURce:]INTHarmonic:FREQuency</b>
Description	Sets the frequency of the interharmonic voltage component for all phases. The query format returns the active setting
Parameters	Frequency
Parameter Format	<nr2>
Example	INTH:FREQ 470
Query Format	<b>[SOURce:]INTHarmonic:FREQuency?</b>
Description	Query format returns the interharmonic frequency setting.
Returned Data Format	<nr2>
Query Example	INTH:FREQ? 470.0000

Command Syntax	<b>[SOURce:]INTHarmonic:FREQuency:DEFault</b>
Description	Sets the default frequency of the inter harmonic voltage component for all phases. The factory default setting is 1800 Hz.
Parameters	Frequency
Parameter Format	<nr2>
Example	INTH:FREQ:DEF 90
Query Format	<b>[SOURce:]INTHarmonic:FREQuency:DEFault?</b>
Description	Query format returns the interharmonic frequency setting.
Returned Data Format	<nr2>
Query Example	INTH:FREQ:DEF? 90.0000

Query Format	<b>[SOURce:]INTHarmonic:FREQuency:MAXimum?</b>
Description	Returns the maximum value for the interharmonic frequency setting which is 10,000 Hz..
Returned Data Format	<nr2>
Query Example	INTH:FREQ:MAX? 10000.0000

Query Format	<b>[SOURce:]INTHarmonic:FREQuency:MINimum?</b>
Description	Returns the minimum value for the interharmonic frequency setting which is 15 Hz..
Returned Data Format	<nr2>
Query Example	INTH:FREQ:MIN? 15.0000

Command Syntax	<b>[SOURCE:]INTHarmonic:VOLTage[:AC#]</b>
Description	Sets the inter harmonic voltage amplitude for the selected phase (1 = A, 2 = B, 3 = C) or for all three phases if the phase selection is omitted in Vac RMS
Parameters	Voltage
Parameter Format	<nr2>
Example	INTH:VOLT:AC1 12.00
Query Format	<b>[SOURCE:]INTHarmonic:VOLTage[:AC#]?</b>
Description	Query format returns the interharmonic amplitude setting.
Returned Data Format	<nr2>
Query Example	INTH:VOLT? 12.0000, 0.0000, 0.0000
Command Syntax	<b>[SOURCE:]INTHarmonic:VOLTage:AC#:DEFault</b>
Description	Sets the default amplitude of the interharmonic voltage component for all phases. The factory default setting is 0.000 Vrms.
Parameters	Frequency
Parameter Format	<nr2>
Example	INTH:VOLT:AC:DEF 5
Query Format	<b>[SOURCE:]INTHarmonic:VOLTage:AC#:DEFault?</b>
Description	Query format returns the interharmonic default amplitude setting.
Returned Data Format	<nr2>
Query Example	INTH:VOLT:AC:DEF? 5.0000, 5.0000, 5.0000
Query Format	<b>[SOURCE:]INTHarmonic:VOLTage:AC#:MAXimum?</b>
Description	Returns the maximum value for the interharmonic amplitude setting which is 300.0000 Vac RMS.
Returned Data Format	<nr2>
Query Example	INTH:VOLT:AC:MAX? 300.0000
Query Format	<b>[SOURCE:]INTHarmonic:VOLTage:AC#:MINimum?</b>
Description	Returns the minimum value for the interharmonic amplitude setting which is 0.0000 Vac RMS.
Returned Data Format	<nr2>
Query Example	INTH:VOLT:AC:MIN? 0.0000

Command Syntax	<b>[SOURCE:]INTHarmonic:PHASe#</b>
Description	This command sets the interharmonic voltage phase angle with respect to the phase A interharmonic fundamental for the selected phase (2 = B, 3 = C) or for both phases if the phase selection is omitted in degrees.
Parameters	Phase
Parameter Format	<nr2>
Example	INTH:PHAS2 45.00
Query Format	<b>[SOURCE:]INTHarmonic:PHASe?</b>
Description	Query format returns the interharmonic voltage phase angle with respect to the phase A setting.
Returned Data Format	<nr2>
Query Example	INTH:PHAS2? 45.0000
Command Syntax	<b>[SOURCE:]INTHarmonic:PHASe#:DEFault</b>
Description	The default interharmonic voltage phase angle for each phase or all phases can be selected using the following command: Factory default is 0.000° for phase A, 120.000° for phase B and 240.000° for phase C.
Parameters	Frequency
Parameter Format	<nr2>
Example	INTH:PHAS2:DEF 90
Query Format	<b>[SOURCE:]INTHarmonic:PHASe#:DEFault?</b>
Description	Query format returns the interharmonic default voltage phase angle setting.
Returned Data Format	<nr2>
Query Example	INTH:PHAS:DEF? 0.0000, 90.0000, 240.0000
Query Format	<b>[SOURCE:]INTHarmonic:PHASe#:MAXimum?</b>
Description	Returns the upper interharmonic voltage phase angle setting range for each phase or all phases. The Maximum set values in 360.000°.
Returned Data Format	<nr2>
Query Example	INTH:PHAS:MAX? 360.0000
Query Format	<b>[SOURCE:]INTHarmonic:PHASe#:MINimum?</b>
Description	Returns the lower interharmonic voltage phase angle setting range for each phase or all phases. Minimum set value is 0.000°.
Returned Data Format	<nr2>
Query Example	INTH:PHAS:MIN? 0.0000

---

Command Syntax	<b>[SOURCE:]INTHarmonic:STATe &lt;b&gt;</b>
Description	This command enables (1) or disables Inter Harmonics mode. When off, no interharmonics are generated. This command can only be sent while the OUTPUT is OFF. If the OUTPUT is ON, an error is generated and no change of state occurs. (“Unable to execute this action with output enabled”).
Parameters	< 0   OFF   1   ON >
Parameter Format	<b>
Example	INTH:STAT ON
Query Format	<b>[SOURCE:]INTHarmonic:STATe?</b>
Description	Query format returns the interharmonic state setting.
Returned Data Format	<b>
Query Example	INTH:STAT? 1

## 8.8 Status Commands

Status commands control status and event registers. These commands are aliases for some of the IEEE488.2 common commands and may be used interchangeably. Refer to section 8.12, “Status and Events Registers” for details on status and event register configurations.

The following status commands are supported.

Command	Description
STATus:OPERation[:EVENT]?	Queries the Operation Status Event Register
STATus:OPERation:CONDition?	Queries the Operation Status Condition Register
STATus:OPERation:ENABLE <nr1>	Sets the Operation Status Enable Register
STATus:OPERation:ENABLE?	Queries the Operation Status Enable Register
STATus:QUESTionable[:EVENT]?	Queries the Questionable Status Event Register
STATus:QUESTionable:CONDition?	Queries the Questionable Status Condition Register
STATus:QUESTionable:ENABLE <nr1>	Sets the Questionable Status Enable Register
STATus:QUESTionable:ENABLE?	Queries the Questionable Status Enable Register
STATus:PRESet	Presets the Status Registers

Query Format                   **STATus:OPERation[:EVENT]?**  
 Description                   Queries the Operation Status Event Register.  
 Returned Data Format       <nr1>  
 Query Example               STAT:OPER?  
                                   0

Query Format                   **STATus:OPERation:CONDition?**  
 Description                   Queries the Operation Status Condition Register.  
 Returned Data Format       <nr1>  
 Query Example               STAT:OPER:COND?  
                                   0

Command Syntax              **STATus:OPERation:ENABLE <nr1>**  
 Description                   Sets the content Operation Status Enable Register.  
 Parameters                   0-32767  
 Parameter Format             <nr1>  
 Example                       STAT:OPER:ENAB 255  
 Query Format                   **STATus:OPERation:ENABLE?**  
 Returned Data Format       <nr1>  
 Query Example               STAT:OPER:ENAB?  
                                   6144

Query Format                   **STATus:QUESTionable[:EVENT]?**  
 Description                   Queries the Questionable Status Event Register.  
 Returned Data Format       <nr1>  
 Query Example               STAT:QUES?  
                                   0

Query Format	<b>STATus:QUEStionable:CONDition?</b>
Description	Queries the Questionable Status Condition Register.
Returned Data Format	<nr1>
Query Example	STAT:QUES:COND? 0
Command Syntax	<b>STATus:QUEStionable:ENABle</b>
Description	Sets the content of the Questionable Status Enable Register.
Parameters	0-32767
Parameter Format	<nr1>
Example	STAT:QUES:ENAB 255
Query Format	<b>STATus:QUEStionable:ENABle?</b>
Returned Data Format	<nr1>
Query Example	STAT:QUES:ENAB? 255
Command Syntax	<b>STATus:PRESet</b>
Description	The Status Preset command presets the Status Registers. The Operational Status Enable Register is set to 0 and the Questionable Status Enable Register is set to 0.
Parameters	None
Parameter Format	n/a
Example	STAT:PRES

## 8.9 System Commands

Systems commands control system level functions or return model and revision information on the connected unit. The following system commands are supported.

### 8.9.1 System Error Commands

**Query Format**                    **SYSTem:ERRor[:NEXT]?**  
**Description**                    This command returns next available error message from the error queue. If no more error messages are available, returns 0, "NO ERROR" result. Available error messages are:

Returned Data Format	<b>ERROR</b>	<b>Description</b>
	-0, "No error"	No error detected
	-100, "Command error"	indicates invalid command or query received
	-102, "Command error: Syntax error."	Incorrect command syntax
	-200, "Execution error"	indicates can't execute command with parameters received
	-222, "Command error: Data out of range."	Data exceeds available parameter range
	-300, "Device-specific error"	indicates UPC not properly configured
	-400, "Query error"	indicates query aborted

**Query Example**                    SYST:ERR?  
-102, "Command error: Syntax error."

**Query Format**                    **SYSTem:ERRor:ALL?**  
**Description**                    Returns all available error messages as a of error numbers and clears the error message queue.

**Returned Data Format**            TOTAL\_ERRORS ,ERRORS,CODE(INDEX),DESCRIPTION(INDEX),  
CODE(INDEX+1), DESCRIPTION(INDEX+1),..., CODE(INDEX+N),  
DESCRIPTION(INDEX+N),...

**Query Example**                    SYST:ERR:ALL?  
0,0  
SYST:ERR:ALL?  
2,2,-102, "Command error: Syntax error. Webpage  
interface.;2022/10/12 18:23:37",-102, "Command error: Syntax error.  
Webpage interface.+2022/10/12 18:23:50"

**Command Syntax**                    **SYSTem:ERRor:ALL:CLEAR**  
**Description**                    This command clears the error message queue.  
**Parameters**                    None  
**Parameter Format**                n/a  
**Example**                            SYST:ERR:ALL:CLEAR



Command Syntax	<b>SYSTem:ERROr:ALL:NOCLEAR? &lt; Optional: Index&gt;</b>
Description	Returns all available error messages as a single unterminated string but does not clear <b>the error message queue</b> .
Returned Data Format	<p>&lt;nr1&gt;,&lt;nr1&gt;,...&lt;nr1&gt;</p> <p>Format of response:          YYYY/MM/DD,HH:MM::SS,S.NS,TOTAL_ERRORS,INDEX,ERRORS,CODE (INDEX),DESCRIPTION(INDEX),CODE(INDEX+1),DESCRIPTION(INDEX+1),...,CODE(INDEX+N),DESCRIPTION(INDEX+N),...</p> <p>Response Legend:  <b>YYYY/MM/DD,HH:MM::SS,S.NS</b> is the timestamp of the latest error pushed to the queue.  <b>S</b> is absolute seconds and <b>NS</b> absolute nanoseconds.  <b>TOTAL_ERRORS</b> are the total errors in the queue.  <b>INDEX</b> is 1 by default if not passed as optional argument.  <b>ERRORS</b> is the total errors returned in the response.          As there may be too many errors the response may return a few of them starting from the <b>INDEX</b>.          The <b>INDEX</b> is useful to navigate the queue.  <b>CODE</b> is the error code and <b>DESCRIPTION</b> the description.</p>
Query Example	<pre>SYST:ERR:ALL:NOCLEAR? 2018/05/29,14:29:53,1207438.903668873,0,1,0</pre> <p><u>For no errors:</u></p> <pre>&gt;SYSTem:ERROr:ALL:NOCLEAR? 2022/10/12,18:17:01,122450.794695832,0,1,0</pre> <p><u>Two errors in the queue:</u></p> <pre>&gt;SYSTem:ERROr:ALL:NOCLEAR? 2022/10/12,18:17:19,122467.903705666,2,1,2,-102,"Command error: Syntax error. Webpage interface.;"2022/10/12 18:17:18",-102,"Command error: Syntax error. Webpage interface.;"2022/10/12 18:17:19" &gt;SYSTem:ERROr:ALL:NOCLEAR? 2 2022/10/12,18:17:19,122467.903705666,2,2,1,-102,"Command error: Syntax error. Webpage interface.;"2022/10/12 18:17:19"</pre>

Command Syntax	<b>SYSTem:ERRor:POE</b>
Description	This command sets the Power on Error reporting mode. Returns status of Power on Error setting as 1 (enabled) or 0 (disabled).
Parameters	< 0   OFF   1   ON >
Parameter Format	<b>
Example	SYST:ERR:POE ON
Query Format	<b>SYSTem:ERRor:POE?</b>
Returned Data Format	<b>
Query Example	SYST:ERR:POE? 1

### 8.9.2 System Information Commands

Command Syntax	<b>SYSTem:BEEP</b>
Description	This command generates an audible beep at the front panel of the power source.
Parameters	None
Parameter Format	n/a
Example	SYST:BEEP

Query Format	<b>SYSTem:FW:FRONTPANEL:VERsion?</b>
Description	Returns the firmware revision for the front panel processor.
Returned Data Format	<cr>
Query Example	SYST:FW:FRONTPANEL:VER? 2.0.0

Query Format	<b>SYSTem:FW:FRONTPANEL:APPS:VERsion?</b>
Description	Returns the firmware revision for the front panel application program.
Returned Data Format	<cr>
Query Example	SYST:FW:FRONTPANEL:APPS:VER? 2.0.0

Query Format	<b>SYSTem:FW:IO:VERsion?</b>
Description	Returns the firmware revision for the Auxiliary I/O board processor on LSX-xA version power sources.
Returned Data Format	<cr>
Query Example	SYST:FW:IO? 1.0.4

Query Format	<b>SYSTem:FW:POWER:VERsion?</b>
Description	Returns the revision number of the power source's power stages.
Returned Data Format	<nr2>-<nr2>
Query Example	SYST:FW:POWER:VER? 81.0.0-77.1.0

Query Format	<b>SYSTem:LANGuage:CATalog?</b>
Description	Returns list of available languages that can be selected for front panel operation.
Returned Data Format	<cr>
Query Example	SYST:LANG? english, chinese
Query Format	<b>SYSTem:LXI:FEATures?</b>
Description	R eturns string listing supported LXI features.
Returned Data Format	<cr>
Query Example	SYST:LXI:FEAT? None
Query Format	<b>SYSTem:LXI:VERSion?</b>
Description	Returns LXI revision compliance version number.
Returned Data Format	<cr>
Query Example	SYST:LXI:VERSION? LXI Core 2011
Query Format	<b>SYSTem:MODE?</b>
Description	Returns LOCAL (0) or REMOTE (1) front panel status. Use IEEE 488.2 command commands *LLO to lock front panel and *GTL to release front panel operation.
Returned Data Format	<b>
Query Example	SYST:MODE? 1
Query Format	<b>SYSTem:SERIALNUM?</b>
Description	Returns the serial number of the power source. Same information can be queried with the *IDN? command
Returned Data Format	<nr1>
Query Example	SYST:HWREV? 0
Query Format	<b>SYSTem:TIME?</b>
Description	Returns real time clock date and time. <b>Note:</b> Since both date and time are returned, there is no SYSTem:DATE?
Returned Data Format	<mm/dd/yy hh:mm:ss:mm
Query Example	SYSTem:TIME? 29/05/2018 14:40:57

Query Format	<b>SYSTem:TIME:SOURce?</b>
Description	Queries source of date and time information.
Returned Data Format	<cr>
Query Example	SYST:TIME:SOUR? NTP <b>Note:</b> NTP stands for “Network Time Protocol”. A protocol built on top of TCP/IP that assures accurate local timekeeping with reference to radio, atomic or other clocks located on the Internet. This protocol is capable of synchronizing distributed clocks within milliseconds over long time periods. It is defined in STD 12, RFC 1119 (RFC = Request for comment. RFCs are used by the Internet Engineering Task Force (IETF) and other standards bodies.
Query Format	<b>SYSTem:TIME:UTC?</b>
Description	Returns the UTC time, independent of the zone.
Returned Data Format	DD/MM/YYYY HH:MM:SS
Query Example	SYST:TIME:UTC? 29/05/2019 14:40:57
Command Syntax	<b>SYSTem:TIME:ZONE &lt;ZONE&gt;</b>
Description	Set the zone, allowed values are GMT+/-X.
Example	SYST:TIME:ZONE GMT-7
Query Format	<b>SYSTem:TIME:ZONE?</b>
Description	Returns the current time zone setting, normally GMT+/-X
Returned Data Format	<cr>
Query Example	SYST:TIME:ZONE? GMT-7
Query Format	<b>SYSTem:TIME:ZONE:CATalog?</b>
Description	Returns the available zones.
Returned Data	GMT-12,GMT-11,GMT-10,GMT-9,GMT-8,GMT-7,GMT-6,GMT-5,GMT-4, GMT-3, GMT-2,GMT-1,GMT+0,GMT+1,GMT+2,GMT+3,GMT+4,GMT+5, GMT+6,GMT+7,GMT+8,GMT+9,GMT+10,GMT+11,GMT+12,GMT+13, GMT+14
Command Syntax	<b>SYSTem:TIME:ZONE:LEAP &lt;0 OFF 1 ON&gt;</b>
Description	Enables or Disables Leap Second mode.
Parameters	1 or ON to consider leap seconds, otherwise 0 or OFF
Example	SYST:TIME:LEAP ON
Query Format	<b>SYSTem:TIME:ZONE:LEAP?</b>
Description	Returns 1 if it considers leap seconds, otherwise 0.
Returned Data	1 = Leap seconds considered, 0 = Leap seconds ignored

<p>Command Syntax Description</p>	<p><b>SYSTem:TIME:SOURce</b> &lt; RTC   NTP &gt; Set the time source, RTC is the local real time clock of the front panel. NTP is internet time protocol. NTP requires internet connection. If NTP is used with internet connection then the RTC is updated every time the NTP synchronizes.</p>
<p>Parameters Example</p>	<p>&lt; RTC   NTP &gt; SYST:TIME:SOUR NTP</p>
<p>Query Format Description Returned Data</p>	<p><b>SYSTem:TIME:SOURce:CATalog?</b> Returns the available time source options, NTP or RTC. NTP, RTC</p>
<p>Query Format Description Returned Data</p>	<p><b>SYSTem:TIME:SOURce:NTP:SERVer?</b> Returns “pool.ntp.org” This is the server that uses the unit NTP service. pool.ntp.org</p>
<p>Command Syntax Description Parameters Example</p>	<p><b>SYSTem:TIME:SOURce:NTP:SYNC</b> &lt;OPTIONAL: SERVER&gt; Forces an NTP sync. If the argument is not passed then it uses “pool.ntp.org”. Any IP/domain that runs a NTP server can be used. Alternative commons servers are “time.windows.com” or “time.nist.gov”. &lt; time server domain &gt; SYST:TIME:SOUR:NTP:SYNC</p>
<p>Command Syntax Description Parameters Example</p>	<p><b>SYSTem:TIME:SOURce:NTP:REStart</b> Restarts the NTP service none SYST:TIME:SOUR:NTP:REST</p>
<p>Query Format Description Returned Data Format Query Example</p>	<p><b>SYSTem:VERSion?</b> Returns SCPI standard revision version. &lt;nr2&gt; SYST:VERS? 1992.0</p>
<p>Query Format Description Returned Data Format Query Example</p>	<p><b>SYSTem:XFMRRATIO?</b> Returns the transformer option (T Option) voltage ratio. If no transformer option is installed and configured, this query will return a value of 0.000. See also the [SOURce:]COUPLing command. &lt;nr2&gt; SYSTem:XFMRRATIO? 1.3333</p>

### 8.9.3 System Interface Soft Key Preset Commands

These commands allow programming of the output programming preset soft key values for the front panel user interface of the power source. The same can be accomplished by the user from the front panel. Using a program to set these values can ensure they are always set to a known value if this is important for operator use of the power source in a specific test situation.

#### 8.9.3.1 Preset Syntax

The syntax for all these commands is very similar. Prefix is always “SYSTem:INTERFace:PRESET:” followed by the parameter. Available soft key preset parameters are:

- VOLTage[:AC]
- FREQuency
- PHASe
- CURRent:LIMit
- POWER:LIMit
- KVA:LIMit

To program or query a specific soft key number (1 ~ 5), append “SK#” to the command where # is a value from 1 through 5 for soft key 1 through 5. (Top soft key = 1, bottom soft key = 5).

#### 8.9.3.2 Command parameters

Available softkey parameters are:

- MIN MIN is the preset value for the min allowable setting based on the power source model
- MAX MAX is the the preset value for the max allowable setting based on the power source model
- DEF DEF sets the preset value to factory default
- Value A <nr1> value between MIN and MAX may be specified instead.

Up to five sets of parameters can be appended to these commands to program more than one soft key for the same parameter setting with a single command string.

Example:

```
SYST:INTERF:PRESET:VOLT MAX, MIN, 108, 140
```

Programs the voltage AC soft keys as follows:

```
SK1 = MAX or 300, SK2 = MIN or 0, SK3 = 108, SK4 = 140.
```

### 8.9.3.3 Preset Commands Listing

The following lists shows all available soft key preset programming commands.

#### Voltage AC

SYSTem:INTERFace:PRESET:VOLTage[:AC] <REQ: MIN|MAX|DEF|Value, OPT: MIN|MAX|DEF|Value, OPT: MIN|MAX|DEF|Value, OPT: MIN|MAX|DEF|Value, OPT: MIN|MAX|DEF|Value>

SYSTem:INTERFace:PRESET:VOLTage[:AC]? <OPT: ALL|DEF> <OPT: ALL|DEF>

SYSTem:INTERFace:PRESET:VOLTage[:AC]:SK# <REQ: MIN|MAX|DEF|Value>

SYSTem:INTERFace:PRESET:VOLTage[:AC]:SK#?

#### Frequency

SYSTem:INTERFace:PRESET:FREQuency <REQ: MIN|MAX|DEF|Value, OPT: MIN|MAX|DEF|Value, OPT: MIN|MAX|DEF|Value, OPT: MIN|MAX|DEF|Value, OPT: MIN|MAX|DEF|Value>

SYSTem:INTERFace:PRESET:FREQuency? <OPT: ALL|DEF> <OPT: ALL|DEF>

SYSTem:INTERFace:PRESET:FREQuency:SK# <REQ: MIN|MAX|DEF|Value>

SYSTem:INTERFace:PRESET:FREQuency:SK#?

#### Current Limit

SYSTem:INTERFace:PRESET:CURRent:LIMit <REQ: MIN|MAX|DEF|Value, OPT: MIN|MAX|DEF|Value, OPT: MIN|MAX|DEF|Value, OPT: MIN|MAX|DEF|Value, OPT: MIN|MAX|DEF|Value>

SYSTem:INTERFace:PRESET:CURRent:LIMit? <OPT: ALL|DEF> <OPT: ALL|DEF>

SYSTem:INTERFace:PRESET:CURRent:LIMit:SK# <REQ: MIN|MAX|DEF|Value>

SYSTem:INTERFace:PRESET:CURRent:LIMit:SK#?

#### Power Limit

SYSTem:INTERFace:PRESET:POWer:LIMit <REQ: MIN|MAX|DEF|Value, OPT: MIN|MAX|DEF|Value, OPT: MIN|MAX|DEF|Value, OPT: MIN|MAX|DEF|Value, OPT: MIN|MAX|DEF|Value>

SYSTem:INTERFace:PRESET:POWer:LIMit? <OPT: ALL|DEF> <OPT: ALL|DEF>

SYSTem:INTERFace:PRESET:POWer:LIMit:SK# <REQ: MIN|MAX|DEF|Value>

SYSTem:INTERFace:PRESET:POWer:LIMit:SK#?

#### Apparent Power Limit

SYSTem:INTERFace:PRESET:KVA:LIMit <REQ: MIN|MAX|DEF|Value, OPT: MIN|MAX|DEF|Value, OPT: MIN|MAX|DEF|Value, OPT: MIN|MAX|DEF|Value, OPT: MIN|MAX|DEF|Value>

SYSTem:INTERFace:PRESET:KVA:LIMit? <OPT: ALL|DEF> <OPT: ALL|DEF>

SYSTem:INTERFace:PRESET:KVA:LIMit:SK# <REQ: MIN|MAX|DEF|Value>

SYSTem:INTERFace:PRESET:KVA:LIMit:SK#?

Examples of programming User Preset Soft keys:

SYST:INTERF:PRESET:VOLT:AC 115.000,230.000,300.000,MAX

SYST:INTERF:PRESET:FREQ 50.000,60.000,400.000,800.000,1200.000

SYST:INTERF:PRESET:CURR:LIM MAX,15.000,5.000

SYST:INTERF:PRESET:POW:LIM MAX,4.000,2.000,1.000

SYST:INTERF:PRESET:KVA:LIM MAX,4.000,2.000,1.000

Examples of programming a specific User Preset Soft key:

SYST:INTERF:PRESET:VOLT:AC:SK1 115

Examples of querying programming User Preset Soft key settings:

SYSTEM:INTERF:PRESET:VOLT:AC? -> 115.000,230.000,300.000,MAX

SYSTEM:INTERF:PRESET:FREQ? -> 50.000,60.000,400.000,800.000,1200.000

SYSTEM:INTERF:PRESET:CURR:LIM? -> MAX,15.000,5.000

SYSTEM:INTERF:PRESET:POW:LIM? -> MAX,4.000,2.000,1.000

SYSTEM:INTERF:PRESET:KVA:LIM? -> MAX,4.000,2.000,1.000

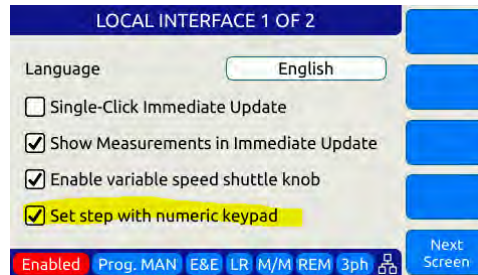
Example of querying programming User Preset for a specific soft key number:

SYST:INTERF:PRESET:VOLT:AC:SK1? -> 115.000



### 8.9.3.4 Other Front Panel Function Commands

These commands are equivalent to some of the functions available in the LOCAL INTERFACE settings.



#### Beeper Volume - Range is 0 through 10:

SYSTem:INTERFace:VOLume <VOLUME>

SYSTem:INTERFace:VOLume?

#### LCD Brightness - Range is 0 through 10:

SYSTem:INTERFace:LCD[:BRIGHTness] <BRIGHTNESS>

SYSTem:INTERFace:LCD[:BRIGHTness]?

#### Keypad Backlit Brightness - Range is 0 through 10:

SYSTem:INTERFace:KEYS:BRIGHTness <BRIGHTNESS>

SYSTem:INTERFace:KEYS:BRIGHTness?

#### Key Press Sounds:

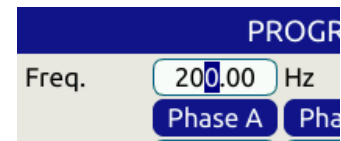
SYSTem:INTERFace:KEYS:SOUNDS <ON|OFF>

SYSTem:INTERFace:KEYS:SOUNDS?

#### Set Resolution Step Size with the numeric keypad

SYSTem:INTERFace:KEYS:STEPset <ON|OFF>

SYSTem:INTERFace:KEYS:STEPset?



#### Single Click Update Mode:

SYSTem:INTERFace:IMMEDIATEupdate:SINGLEclick <ON|OFF>

SYSTem:INTERFace:IMMEDIATEupdate:SINGLEclick?

#### Show Measurements in Immediate Update:

SYSTem:INTERFace:IMMEDIATEupdate:SHOWMEASurements <ON|OFF>

SYSTem:INTERFace:IMMEDIATEupdate:SHOWMEASurements?

#### Variable Shuttle Knob Speed - Range is 0 through 10:

SYSTem:INTERFace:KNOB:SPEED <SPEED>

SYSTem:INTERFace:KNOB:SPEED?

### 8.9.4 System Configuration Commands

Query Format	<b>SYSTem:FEATures?</b>
Description	Returns the available features and functions that are configured on the unit. Note that some features may require options and may not be present on your unit.
Returned Data Format	<cr>
Query Example	SYST:FEAT? Trigger output,Trigger input,Strobe source,Strobe output,I/O Board,GPIB,Enhanced controller,Single phase,Split phase,Three phase,Programmable phase,Transient,Harmonic analysis and waveform scope,Programmable impedance,Arbitrary waveforms,Extended frequency,True line to line measurement,Watt-hour meter,Peak current register,AC voltage
Query Format	<b>SYSTem:MAXKVA?</b>
Description	Returns maximum available kVA output capability of the power source. Example for 360LSX model = 2000
Returned Data Format	<nr2>
Query Example	SYST:MAXKVA? 15.000
Query Format	<b>SYSTem:MAXCURRent?</b>
Description	Returns maximum available RMS output current capability of the power source. Example for 360LSX model = 16.00
Returned Data Format	<nr2>
Query Example	SYST:MAXCURR? 41.6667
Query Format	<b>SYSTem:MAXVOLTage?</b>
Description	Returns maximum available RMS voltage output capability of the power source. Example for 360LSX model = 135
Returned Data Format	<nr1>
Query Example	SYST:MAXVOLT? 300
Command Syntax	<b>SYSTem:COMPAtible</b>
Description	Sets Pacific Power Source UPC controller compatibility mode. This mode allows use of the power source with legacy software.
Parameters	< 0   DISABLE   1   UPC >
Parameter Format	
Example	SYST:COMP UPC
Query Format	<b>SYSTem:COMPAtible?</b>
Returned Data Format	<b>
Query Example	SYST:COMP? 1

---

Query Format	<b>SYSTem:HWREVision?</b>
Description	Returns the hardware revision letter of the power source
Returned Data Format	<cr>
Query Example	SYST:HWREV? A
Command Syntax	<b>SYSTem:LANGuage</b>
Description	Sets Pacific Power Source UPC controller compatibility mode. This mode allows use of the power source with legacy software.
Parameters	< english   Chinese > <b>Note:</b> Refer to SYSTem:LANGuage:CATalog? query command for list of supported languages.
Parameter Format	<cr>
Example	SYST:LANG chinese
Query Format	<b>SYSTem:LANGuage?</b>
Returned Data Format	<b>
Query Example	SYST:LANG? chinese

### 8.9.5 Parallel System Commands

Command Syntax	<b>SYSTem:DISCOVERY</b>
Description	Initiates discovery of the number of paralleled power sources
Parameters	None
Parameter Format	n/a
Example	SYST:DISCOVERY
Query Format	<b>SYSTem:PARALLELUNITS?</b>
Description	Returns the number of power sources found.
Returned Data Format	<nr1>
Query Example	SYST:PARALLELUNITS? 1
Command Syntax	<b>SYSTem:PARALLELUNITS:EXPEcted</b>
Description	Sets the number of power sources that should be connected to the system interface bus.
Parameters	1 – 200
Parameter Format	<nr1>
Example	SYST:PARALLELUNITS:EXPE 4
Query Format	<b>SYSTem:PARALLELUNITS:EXPEcted?</b>
Returned Data Format	<nr1>
Query Example	SYST:PARALLELUNITS:EXPE? 4

### 8.9.6 System Sanitization Commands

Query Format	<b>SYSTem:SANITIZE:CODE?</b>
Description	Returns sanitization password string.
Returned Data Format	<nr1>
Query Example	SYSTem:SANITIZE:CODE? 0659
Command Syntax	<b>SYSTem:SANITIZE &lt;code&gt;</b>
Description	Erases all user data stored in non-volatile memory settings including settings and custom waveforms if required. The code is obtained by the query command above.
Parameters	None
Parameter Format	n/a
Example	SYST:SANITIZE 0659

### 8.9.7 Communication LAN Commands

Command Syntax	<b>SYSTem:COMMunicate:LAN[:ENABLE]</b>
Description	This command turns remote control via LAN on or off. To control the power source through its LAN interface, this state has to on (1).
Parameters	< 0   OFF   1 ON >
Parameter Format	<b>
Example	SYST:COMM:LAN ON
Query Format	<b>SYSTem:COMMunicate:LAN[:ENABLE]?</b>
Returned Data Format	
Query Example	SYST:COMM:LAN? 1
Query Format	<b>SYSTem:COMMunicate:LAN:STATus?</b>
Description	This command returns all LAN settings in a single comma delimited string of values.
Returned Data Format	<cr>, <cr>,.....,<cr>,<cr>
Query Example	SYSTem:COMMunicate:LAN:STATus? 192.168.14.22,255.255.254.0,192.168.15.254,192.168.15.208,LSX-106378937,LSX-106378889,0,1,0

<p>Command Syntax Description</p>	<p><b>SYSTem:COMMunicate:LAN:DHCP[:ENABLE]</b> This command turns DHCP mode for the LAN interface on or off. DHCP = Dynamic Host Configuration Protocol". This protocol automatically provides an IP address and other related information such as the subnet mask and default gateway. When turned off, a static IP address must be assigned by the user instead.</p>
<p>Parameters Parameter Format Example Query Format Returned Data Format Query Example</p>	<p>&lt; 0   OFF   1   ON &gt; &lt;b&gt; SYST:COMM:LAN:DHCP ON <b>SYSTem:COMMunicate:LAN:DHCP[:ENABLE]?</b> &lt;b&gt; SYST:COMM:LAN:DHCP? 1</p>
<p>Command Syntax Description</p>	<p><b>SYSTem:COMMunicate:LAN:DHCP:RENEW</b> This command renews the lease of an IP address assigned through the DHCP protocol. This may be necessary if the power source has not been used in a while and its IP address lease has expired. If not renewed, a different IP address may be assigned.</p>
<p>Parameters Parameter Format Example</p>	<p>None n/a SYST:COMM:LAN:DHCP:RENEW</p>
<p>Command Syntax Description</p>	<p><b>SYSTem:COMMunicate:LAN:ADDress</b> This command is used to assign a fixed IP address to the power source for LAN communication.</p>
<p>Parameters Parameter Format Example Query Format Returned Data Format Query Example</p>	<p>ddd.ddd.ddd.ddd (four octets ranging in value from 0 to 255 representing one 16 bit unsigned integer value each. &lt;cr&gt; SYST:COMM:LAN:ADD 132.18.21.105 <b>SYSTem:COMMunicate:LAN:ADDress?</b> &lt;cr&gt; SYST:COMM:LAN:ADD? 132.18.21.105</p>
<p>Query Format Description</p>	<p><b>SYSTem:COMMunicate:LAN:MACaddress?</b> This query returns the MAC address of the connected power source. The Media Access Control address or MAC address is also referred to as physical address as it is fix and unique to any device on the network. The MAC address for the power source is also printed on the rear panel near the LAN interface connector. It consists of 8 sets of hexadecimal 16 bit unsigned integer values.</p>
<p>Returned Data Format Query Example</p>	<p>&lt;cr&gt; SYST:COMM:LAN:MAC? 3A.3F.00.4C.DE.AA.39.8F</p>

Query Format	<b>SYSTem:COMMunicate:LAN:VISA?</b>
Description	Queries the VISA resource name / address string
Returned Data Format	<cr>
Query Example	TCPIP::LSX-1003::INSTR
Command Syntax	<b>SYSTem:COMMunicate:LAN:APPLY</b>
Description	Applies all changes send using the COMM:LAN commands.
Parameters	None
Parameter Format	n/a
Example	SYST:COMM:LAN:APP
Command Syntax	<b>SYSTem:COMMunicate:LAN:MASK</b>
Description	This command sets the IP mark value for the power source LAN interface. It is normally obtained through DHCP. If a static IP must be used, the mask has to set as well.
Parameters	ddd.ddd.ddd.ddd (four octets ranging in value from 0 to 255 representing one 16 bit unsigned integer value each.
Parameter Format	<cr>
Example	SYST:COMM:LAN:MASK 255.255.254.0
Query Format	<b>SYSTem:COMMunicate:LAN:MASK?</b>
Returned Data Format	<cr>
Query Example	SYST:COMM:LAN:MASK? 255.255.254.0
Command Syntax	<b>SYSTem:COMMunicate:LAN:DNSaddress</b>
Description	Sets the IP address for the DNS server
Parameters	ddd.ddd.ddd.ddd (four octets ranging in value from 0 to 255 representing one 16 bit unsigned integer value each.
Parameter Format	<cr>
Example	SYST:COMM:LAN:DNS 132.18.21.208
Query Format	<b>SYSTem:COMMunicate:LAN:DNSaddress?</b>
Returned Data Format	<cr>
Query Example	SYST:COMM:LAN:DNS? 132.18.21.208
Command Syntax	<b>SYSTem:COMMunicate:LAN:GWAddress</b>
Parameters	Sets the IP address for the Network Gateway. A default gateway is the node on the computer network that the network software uses when an IP address does not match any other routes in the routing table
Parameter Format	<cr>
Example	SYST:COMM:LAN:GWAD 132.18.21.254
Query Format	<b>SYSTem:COMMunicate:LAN:GWAddress?</b>
Returned Data Format	<cr>
Query Example	SYST:COMM:LAN:GWAD? 132.18.21.254

<p>Command Syntax Description</p>	<p><b>SYSTem:COMMunicate:LAN:HOST:CONFigured</b> Sets the network host address. The host address is the portion of the address used to identify hosts (any device requiring a Network Interface Card, such as a PC or networked printer) on the network. The network ID, by contrast, is the portion of the address that refers to the network itself.</p>
<p>Parameters</p>	<p>ddd.ddd.ddd.ddd (four octets ranging in value from 0 to 255 representing one 16 bit unsigned integer value each.</p>
<p>Parameter Format</p>	<p>&lt;cr&gt;</p>
<p>Example</p>	<p>SYST:COMM:LAN:HOST 132.18.21.0</p>
<p>Query Format</p>	<p><b>SYSTem:COMMunicate:LAN:HOST:CONFigured?</b></p>
<p>Returned Data Format</p>	<p>&lt;cr&gt;</p>
<p>Query Example</p>	<p>SYST:COMM:LAN:HOST:CONF? 132.18.21.0</p>
<p>Command Syntax Description</p>	<p><b>SYSTem:COMMunicate:LAN:PASSword</b> Assign a password to enable or disable LAN communications. This feature allows the owner/operator to disable or enable remote LAN access or limit functionality over LAN. <b>Note:</b> There is no query format for this command so the password code cannot be queried back.</p>
<p>Parameters</p>	<p>Four digit passcode</p>
<p>Parameter Format</p>	<p>&lt;nr1?&gt;</p>
<p>Example</p>	<p>SYST:COMM:LAN:PASS 1234</p>
<p>Command Syntax Description</p>	<p><b>SYSTem:COMMunicate:LAN:PORT</b> Sets LAN interface port address. For SCPI message communications, the standard port number is 5025.</p>
<p>Parameters</p>	<p>1024–49151, default = 5025</p>
<p>Parameter Format</p>	<p>&lt;nr1&gt;</p>
<p>Example</p>	<p>SYST:COMM:LAN:PORT 5025</p>
<p>Query Format</p>	<p><b>SYSTem:COMMunicate:LAN:PORT?</b></p>
<p>Returned Data Format</p>	<p>&lt;nr1&gt;</p>
<p>Query Example</p>	<p>SYST:COMM:LAN:PORT? 5025</p>
<p>Command Syntax Description</p>	<p><b>SYSTem:COMMunicate:LAN:PORT:TELNET</b> Sets the port address for TELNET protocol</p>
<p>Parameters</p>	<p>1024–49151, default = 5024</p>
<p>Parameter Format</p>	<p>&lt;nr1&gt;</p>
<p>Example</p>	<p>SYST:COMM:LAN:PORT:TELNET 5024</p>
<p>Query Format</p>	<p><b>SYSTem:COMMunicate:LAN:PORT:TELNET?</b></p>
<p>Returned Data Format</p>	<p>&lt;nr1&gt;</p>
<p>Query Example</p>	<p>SYST:COMM:LAN:PORT:TELNET? 5024</p>



### 8.9.8 Communication Serial Port Commands

Command Syntax	<b>SYSTem:COMMunicate:SERial[:ENABLE]</b>
Description	This command is used to turn the RS232 serial interface on or off. To use this interface for remote control of the power source, it must be set to ON.
Parameters	< 0   OFF   1   ON >
Parameter Format	<b>
Example	SYST:COMM:SER ON
Query Format	<b>SYSTem:COMMunicate:SERial[:ENABLE]?</b>
Returned Data Format	<b>
Query Example	SYST:COMM:SER? 1
Query Format	<b>SYSTem:COMMunicate:SERial:STATus?</b>
Description	This command returns all serial port settings
Returned Data Format	Baud rate, status,data bits, stop bits, parity, flow control
Query Example	SYST:COMM:SER:STAT? 921600,0,8,1,0,0
Command Syntax	<b>SYSTem:COMMunicate:SERial:BAUD</b>
Description	This command sets the baud rate for the serial port.
Parameters	< 1200   1800   2400   4800   9600   14400   19200   38400   57600   62500   115200   230400   460800   500000   576000   921600 >
Parameter Format	<nr1>
Example	SYST:COMM:SER:BAUD 115200
Query Format	<b>SYSTem:COMMunicate:SERial:BAUD?</b>
Returned Data Format	<cr1>
Query Example	SYST:COMM:SER:BAUD? 115200
Command Syntax	<b>SYSTem:COMMunicate:SERial:PARity</b>
Description	This command sets the parity for the serial port.
Parameters	< 0   NONE   1   OFF   2   EVEN >
Parameter Format	<nr1>
Example	SYST:COMM:SERial:PAR NONE
Query Format	<b>SYSTem:COMMunicate:SERial:PARity?</b>
Returned Data Format	<nr1>
Query Example	SYST:COMM:SER:PAR? 0

Command Syntax	<b>SYSTem:COMMunicate:SERial:BITS</b>
Description	This command sets the number of data bits used for serial communications. Available settings are 7 or 8
Parameters	< 7   8 >
Parameter Format	<nr1>
Example	SYST:COMM:SER:BITS 8
Query Format	<b>SYSTem:COMMunicate:SERial:BITS?</b>
Returned Data Format	<nr1>
Query Example	SYST:COMM:SER:BITS? 8
Command Syntax	<b>SYSTem:COMMunicate:SERial:SBITs</b>
Description	This command sets the number of stop bits used for serial communications. Available settings are 1 or 2.
Parameters	< 1   2 >
Parameter Format	<nr1>
Example	SYST:COMM:SER:SBIT 2
Query Format	<b>SYSTem:COMMunicate:SERial:SBITs?</b>
Returned Data Format	<nr1>
Query Example	SYST:COMM:SER:SBIT? 2
Command Syntax	<b>SYSTem:COMMunicate:SERial:FLOWcontrol</b>
Description	This command sets the method of handshaking used for serial communications. Available settings are Xon/Xoff or Hardware handshake.
Parameters	< 0   OFF   1   ON >
Parameter Format	<b>
Example	SYST:COMM:SER:FLOW ON
Query Format	<b>SYSTem:COMMunicate:SERial:FLOWcontrol?</b>
Returned Data Format	<nr1>
Query Example	SYST:COMM:SER:FLOW? 1

### 8.9.9 Communication USB Commands

Command Syntax	<b>SYSTem:COMMunicate:USB:VIRTualport[:ENABLE]</b>
Description	This command enables USB device control using virtual comm driver.
Parameters	< 0   OFF   1   ON >
Parameter Format	<b>
Example	SYST:COMM:USB:VIRT ON
Query Format	<b>SYSTem:COMMunicate:USB:VIRTualport[:ENABLE]?</b>
Returned Data Format	<b>
Query Example	SYST:COMM:USB:VIRT? 1

Command Syntax	<b>SYSTem:COMMunicate:USB:LAN[:ENABLE]</b>
Description	Enables access to embedded webserver using virtual IP Address through USB interface.
Parameters	< 0   OFF   1   ON >
Parameter Format	<b>
Example	SYST:COMM:USB:ETH ON
Query Format	<b>SYSTem:COMMunicate:USB:LAN[:ENABLE]?</b>
Returned Data Format	<b>
Query Example	SYST:COMM:USB:LAN? 1
Command Syntax	<b>SYSTem:COMMunicate:USB:LAN:ADDRESS</b>
Description	Sets the embedded webserver virtual IP Address for USB interface.
Parameters	< 0   OFF   1   ON >
Parameter Format	<b>
Example	SYST:COMM:USB:LAN ON
Query Format	<b>SYSTem:COMMunicate:USB:LAN:ADD?</b>
Returned Data Format	<b>
Query Example	SYST:COMM:USB:LAN:ADD? 192.168.123.1
Command Syntax	<b>SYSTem:COMMunicate:USB:LAN:APPLY</b>
Description	Applies IP settings for Virtual USB Lan interface.
Parameters	None
Parameter Format	N/A
Example	SYST:COMM:USB:LAN:APP
Command Syntax	<b>SYSTem:COMMunicate:USB:LAN:MASK</b>
Description	Sets the embedded webserver virtual IP Mask Address for USB interface.
Parameters	IP Mask
Parameter Format	<cr>
Example	SYST:COMM:USB:LAN ON
Query Format	<b>SYSTem:COMMunicate:USB:LAN:MASK?</b>
Returned Data Format	<cr>
Query Example	SYST:COMM:USB:LAN:MASK? 255.255.255.0

### 8.9.10 Communication GPIB Commands

Command Syntax	<b>SYSTem:COMMunicate:GPIB:ADDRESS &lt;nr1&gt;</b>
Description	This command sets the GPIB address.
Parameters	< 1..30 >
Parameter Format	<nr1>
Example	SYST:COMM:GPIB:ADD 5
Query Format	<b>SYSTem:COMMunicate:GPIB:ADDRESS?</b>
Returned Data Format	<nr1>
Query Example	SYST:COMM:GPIB:ADD? 5

Command Syntax	<b>SYSTem:COMMunicate:GPIB:ENABLE</b>
Description	Enables access to embedded webserver using virtual IP Address through USB interface.
Parameters	< 0   OFF   1   ON >
Parameter Format	<b>
Example	SYST:COMM:GPIB:EANB 1
Query Format	<b>SYSTem:COMMunicate:GPIB:ENABLE?</b>
Returned Data Format	<b>
Query Example	SYST:COMM:GPIB:ENAB? 1

Command Syntax	<b>SYSTem:COMMunicate:GPIB:BAUDrate</b>
Description	Sets the internal serial link speed between the GPIB interface and the front panel processor. This setting is set to 921600 bps as a default and should only be changed to a lower setting if there is a problem with the GPIB interface not working reliably.
Parameters	< 1200   1800   2400   4800   9600   14400   19200   38400   57600   62500   115200   230400   460800   500000   576000   921600 >
Parameter Format	<nr1>
Example	SYST:COMM:GPIB:BAUD 921600
Query Format	<b>SYSTem:COMMunicate:GPIB:BAUDrate?</b>
Returned Data Format	<nr1>
Query Example	SYST:COMM:GPIB:BAUD? 921600

### 8.9.11 System Firmware Commands

Query Format	<b>SYSTem:FW:POWER[:VERsion]?</b>
Description	This command returns the firmware revision of the power converter DSP's. This information is for reference only.
Returned Data Format	<cr><cr>
Query Example	SYST:FW:POWER:VER? 81.0.0.RC8-77.1.0
Query Format	<b>SYSTem:FW:FRONTPANEL:VERsion?</b>
Description	This command returns the firmware revision of front panel controller processor. This information is for reference only.
Returned Data Format	<cr>
Query Example	SYST:FW:FRONTPANEL:VER? 2.0.0
Query Format	<b>SYSTem:FW:FRONTPANEL:APPS:VERsion?</b>
Description	This command returns the firmware revision of front panel controller user interface application. This information is for reference only. Note: This revision number is also returned as part of the *IDN? query response.
Returned Data Format	<cr>
Query Example	SYST:FW:FRONTPANEL:APPS:VER? 2.0.0
Query Format	<b>SYSTem:HWREVision?</b>
Description	This command returns the hardware revision (build) of the power source.
Returned Data Format	<nr2>
Query Example	SYST:HWREV? 0

### 8.9.12 System Remote Access Commands

Command Syntax	<b>SYSTem:REMOte:ACCESS</b>
Description	Sets remote access permission.
Parameters	<0   DISABLED   1   ENABLED>
Parameter Format	<b>
Example	SYST:REM:ACCESS 1
Query Format	<b>SYSTem:REMOte:ACCESS?</b>
Returned Data Format	<cr>
Query Example	SYST:REM:ACCESS? 1
Command Syntax	<b>SYSTem:REMOte:ACCESS:REQuest</b>
Description	This commands results in a pop up dialog on the front panel display requesting the local user to ACCEPT. Confirms presence of a person at the location of the instrument.
Parameters	Alias name. (This argument is optional)
Parameter Format	<cr>
Example	SYSTem:REMOte:ACCESS:REQuest
Query Format	None
Command Syntax	<b>SYSTem:REMOte:ACCESS:LOGIN</b>
Description	This command uses a password as an argument to request access to the instrument. The password can be set on the front panel or using the <b>SYSTem:REMOte:PASSword</b> command
Parameters	Password
Parameter Format	<nr1>
Example	SYSTem:REMOte:ACCESS:LOGIN 1234
Query Format	None
Command Syntax	<b>SYSTem:REMOte:ACCESS:MESSAge &lt;cr&gt;</b>
Description	Allows a user specific message to be displayed at the bottom of the Access Control Browser dialog informing anyone requesting access whom to contact.
Parameters	User Message
Parameter Format	<cr>
Example	SYSTem:REMOte:ACCESS:MESS "Unit is used by John. Please contact 123456789."
Query Format	<b>SYSTem:REMOte:ACCESS:MESSAge?</b>
Returned Data Format	<cr>
Query Example	SYST:REM:ACCESS:MESS? "Unit is used by John. Please contact 123456789."

Command Syntax	<b>SYSTem:REMote:ACCESS:MONItor &lt;b&gt;</b>
Description	Enables or disables remote access monitor mode only. ON by default for backward compatibility.
Parameters	< 0   OFF   1   ON >
Parameter Format	<b> or <cr>
Example	SYSTem:REMote:ACCESS:MONI ON
Query Format	<b>SYSTem:REMote:ACCESS:MONItor?</b>
Returned Data Format	<b>
Query Example	SYST:REM:ACCESS:MONI? 1
Command Syntax	<b>SYSTem:REMote:FTP:ENAbLe</b>
Description	Enable/disable the FTP service.
Parameters	<0   OFF   1   ON>
Parameter Format	<b>
Example	SYST:REM:FTP:ENA 1
Query Format	<b>SYSTem:REMote:FTP:ENAbLe?</b>
Returned Data Format	<b>
Query Example	SYST:REM:FTP:ENA? 1
Command Syntax	<b>SYSTem:REMote:FTP:PASSword</b>
Description	Sets remote FTP access permission password.
Parameters	password
Parameter Format	<cr>
Example	SYST:REM:FTP:PASS temporal
Query Format	<b>SYSTem:REMote:FTP:PASSword?</b>
Returned Data Format	<cr>
Query Example	SYST:REM:FTP:PASS? temporal
Command Syntax	<b>SYSTem:REMote:SMB:ENAbLe</b>
Description	Enable/disable the samba service.
Parameters	<0   OFF   1   ON>
Parameter Format	<b>
Example	SYST:REM:FTP:ENA 1
Query Format	<b>SYSTem:REMote:SMB:ENAbLe?</b>
Returned Data Format	<b>
Query Example	SYST:REM:SMB:ENA? temporal

Command Syntax	<b>SYSTem:REMote:SMB:PASSword</b>
Description	Sets remote Samba services access permission password
Parameters	password
Parameter Format	<cr>
Example	SYST:REM:SMB:PASS temporal
Query Format	<b>SYSTem:REMote:SMB:PASSword?</b>
Returned Data Format	<cr>
Query Example	SYST:REM:SMB:PASS? temporal

### 8.9.13 System Regional Setting Commands

These commands are used to set regional setting for Dates, Times and Decimal separators. They are relevant when exporting or importing CSV files for use in applications like MS Excel or MS Word.

Command: **SYSTem:REGion:DATEFormat <FORMAT>**

Sets the date display format as either **DD/MM/YYYY** (Asia) EU or **MM/DD/YYYY** (USA)

Example: SYST:REG:DATE DD/MM/YYYY

Query: **SYSTem:REGion:DATEFormat?**

Example: SYST:REG:DATE?  
DD/MM/YYYY

Command: **SYSTem:REGion:DATEFormat:CATalog?**

Returns: MM/DD/YYYY,DD/MM/YYYY

Command: **SYSTem:REGion:DECImsymbol <SEPARATOR>**

Sets the decimal separator to either a comma (Asia, EU) or a period (USA). Parameters are "." Or ",".

Example: SYST:REG:DECI ","

Query: **SYSTem:REGion:DECImsymbol?**

Returns decimal separator setting.

Examples SYST:REG:DATE?  
,

### 8.9.14 Miscellaneous System Commands

Command Syntax	<b>SYSTem:BEEP</b>
Description	This command generates a beep from the front panel speaker. May be used in ATE programs to get operator's attention. Make sure the beep volume is not set to 0. See <b>SYSTem:INTERFace:VOLume</b> cmd.
Returned Data Format	<cr>,...,<cr>
Query Format	None



Query Format	<b>SYSTem:MEMory:CATalog?</b>
Description	This command returns the available memory types catalog.
Returned Data Format	<cr>, ..., <cr>
Query Example	SYST:MEM:CAT? INTERNAL, RAM
Command Syntax	<b>SYSTem:MEMory:REMove</b>
Description	This command unmounts system memory.
Returned Data Format	<cr>, ..., <cr>
Query Format	None
Command Syntax	<b>SYSTem:DELeTe &lt;PATH&gt;</b>
Description	This command deletes a file or folder. The path or filename can be between double quotation marks or not.
Parameters	PATH or FILE
Parameter Format	<cr>
Example	SYST:DEL internal/program/program_1.xml SYST:DEL "internal/program/program_1.xml" SYST:DEL temporal/program/program_1.xml SYST:DEL "temporal/program/program_1.xml"
Query Format	none
Query Format	<b>SYSTem:FILE:TYPE? &lt;MEM&gt;</b>
Description	This command returns the file type in numeric available memory types catalog.
Returned Data Format	<nr1>
Query Example	SYST:FILE:TYPE? RAM 0 SYST:FILE:TYPE? INTERNAL 0
Command Syntax	<b>SYSTem:SCREENshot</b>
Description	This command takes a screen shot of the LCD display. The LCD image is saved as a ".png" format image file to folder "internal/screenshots"
Parameters	None
Parameter Format	N/A
Example	SYST:SCREEN
Query Format	none

### 8.9.15 System Import / Export Commands

These commands allow complete system configurations to be exported or imported.

Command Syntax	<b>SYSTem:EXPort &lt;OPT: CONFIGURATION, OPT: WAVEFORMS, OPT: PROGRAMS, OPT: SETPOINTS, OPT: [NAME, NAMEFILE]&gt;</b>
Description	Exports complete record of system configuration of the power source to a compressed file. If argument name is omitted it is stored in temporal/DATE—TIME.7z otherwise in temporal/NAMEFILE.7z. The others arguments indicate what is going to be exported, if none of them are passed all is going to be exported.
Parameters	<b>&lt;OPT: CONFIGURATION, OPT: WAVEFORMS, OPT: PROGRAMS, OPT: SETPOINTS, OPT: [NAME, NAMEFILE]&gt;</b>
Parameter Format	<cr>
Example	SYST:EXPORT SYST:EXPORT NAME,TEST SYST:EXPORT SETPOINTS,NAME,TEST2 SYST:EXPORT SETPOINTS, WAVEFORMS,NAME,TEST3

Command Syntax	<b>SYSTem:IMPOrt &lt;OPT: CONFIGURATION, OPT: WAVEFORMS, OPT: PROGRAMS, OPT: SETPOINTS, [NAME, NAMEFILE]&gt;</b>
Description	Imports complete system configuration records of the power source. The compressed file has to be in /temporal/NAMEFILE.7z. The other others arguments indicate what will be imported, if none of them are passed all is going to be imported.
Parameters	<b>&lt;OPT: CONFIGURATION, OPT: WAVEFORMS, OPT: PROGRAMS, OPT: SETPOINTS, [NAME, NAMEFILE]&gt;</b>
Parameter Format	<cr>
Example	SYST:IMPORT NAME,TEST

### 8.9.16 Miscellaneous Remote Restart Commands

Command Syntax	<b>SYSTem:COMMunicate:LXI:REStArt</b>
Description	Restarts the LXI interface.
Parameters	None
Parameter Format	n/a
Example	SYST:COMM:LXI:REST

Command Syntax	<b>SYSTem:REMOte:FTP:REStArt</b>
Description	Restarts the FTP Server.
Parameters	None
Parameter Format	n/a
Example	SYST:REM:FTP:REST

Command Syntax	<b>SYSTem:REMOte:SMB:REStart</b>
Description	Restarts the Samba Server.
Parameters	None
Parameter Format	n/a
Example	SYST:REM:SMB:REST
Command Syntax	<b>SYSTem:RESTART</b>
Description	Restarts the SPCI Processor.
Parameters	None
Parameter Format	n/a
Example	SYST:RESTART
Command Syntax	<b>SYSTem:INTERFace:REStart</b>
Description	Restarts the Display Processor.
Parameters	None
Parameter Format	n/a
Example	SYST:INTERF:REST

## 8.10 Auxiliary I/O System Commands

Commands specific to the auxiliary I/O functions are listed in this section.

### 8.10.1 Analog & Digital IO Programming Commands

SYSTem:AIO

```

:INput[1 | 2 | 3 |.4][?]
:CATalog?
:GAIN[?]
:DEFault?
:MAXimum?
:MINimum?
:OFFSEt[?]
:DEFault?
:MAXimum?
:MINimum?
:RANGe[?]
:DEFault?
:MAXimum?
:MINimum?
:UNITs?
:VOLTage?
:OUTput[1 | 2 | 3 |.4][?]
:CATalog?
:GAIN[?]
:DEFault?
:MAXimum?
:MINimum?
:OFFSEt[?]
:DEFault?
:MAXimum?
:MINimum?

```

```

:RANGe[?]
:DEFault?
:MAXimum?
:MINimum?
:UNITs?
:VOLTage?

SYSTem:DIO
:INput[1 | 2 | 3 |.4][?]
:FALLing[?]
:FILTersize[?]
:DEFault?
:MAXimum?
:MINimum?
:RISing[?]
:OUTput[1 | 2 | 3 |.4][?]
:CATalog?
:INVert[?]
:STATe?
:REMote
:ENable[?]
:INHibit[?]
:STROBE
:OUTPutstate[?]
:SOURce[?]
:TRANsient[?]

```

#### 8.10.1.1 SYSTem:AIO:Input

Command Syntax	<b>SYSTem:AIO:INput[n] &lt;cr&gt;</b>
Description	Sets the LSX parameter to be controlled by the analog input.
Parameters	[ CURR:LIM   CURR:LIM1   CURR:LIM2   CURR:LIM3   FREQ   KVA:LIM   KVA:LIM1   KVA:LIM2   KVA:LIM3   OFF   PHAS2   PHAS3   POW:LIM   POW:LIM1   POW:LIM2   POW:LIM3   VOLT:AC   VOLT:AC1   VOLT:AC2   VOLT:AC3   VOLT:DC   VOLT:DC1   VOLT:DC2   VOLT:DC3 ] See the “SYSTem:AIO:INput:CATalog?” command response for a list of supported parameters.
Parameter Format	<cr>
Example	SYST:AIO:IN1 VOLTAGE
Query Format	<b>SYSTem:AIO:INput[n]?</b>
Returned Data Format	<cr>
Query Example	SYST:AIO:IN1? VOLTAGE

Query Format	<b>SYSTem:AIO:INput:CATalog?</b>
Description	Returns list of available analog inputs
Returned Data Format	<cr>
Query Example	SYST:AIO:IN:CAT? CURR:LIM,CURR:LIM1,CURR:LIM2,CURR:LIM3,FREQ,KVA:LIM,KVA:LIM1,KVA:LIM2,KVA:LIM3,OFF,PHAS2,PHAS3,POW:LIM,POW:LIM1,POW:LIM2,POW:LIM3,VOLT:AC,VOLT:AC1,VOLT:AC2,VOLT:AC3,VOLT:DC,VOLT:DC1,VOLT:DC2,VOLT:DC3
Command Syntax	<b>SYSTem:AIO:INput[n]:GAIN &lt;nr2&gt;</b>
Description	Sets the full-scale gain of the LSX parameter controlled by the analog input.
Parameters	Full scale value
Parameter Format	<nr2>
Example	SYST:AIO:IN1:GAIN 230.0
Query Format	<b>SYSTem:AIO:INput[n]:GAIN?</b>
Returned Data Format	<nr2>
Query Example	SYST:AIO:IN1:GAIN? 230.00
Query Format	<b>SYSTem:AIO:INput[n]:GAIN:DEFAult?</b>
Description	Returns the default full-scale gain for the specified analog input.
Parameters	None
Returned Data Format	<nr2>
Query Example	SYST:AIO:IN1:GAIN:DEF? 300.0
Query Format	<b>SYSTem:AIO:INput[n]:GAIN:MAXimum?</b>
Description	Returns the maximum full-scale gain for the specified analog input.
Parameters	None
Returned Data Format	n/a
Query Example	SYST:AIO:IN1:GAIN:MAX? 100000.000000
Query Format	<b>SYSTem:AIO:INput[n]:GAIN:MINimum?</b>
Description	Returns the minimum full-scale gain for the specified analog input.
Parameters	None
Returned Data Format	n/a
Query Example	SYST:AIO:IN1:GAIN:MIN? -100000.000000

Command Syntax	<b>SYSTem:AIO:INput[n]:OFFSET &lt;nr2&gt;</b>
Description	Sets the offset of the LSX parameter controlled by the analog input.
Parameters	Offset
Parameter Format	<nr2>
Example	SYST:AIO:IN1:OFFSET 50.0
Query Format	<b>SYSTem:AIO:INput[n]:OFFSET?</b>
Returned Data Format	<nr2>
Query Example	SYST:AIO:IN1:OFFSET? 15.00
Query Format	<b>SYSTem:AIO:INput[n]:OFFSET:DEFault?</b>
Description	Returns the default offset for the specified analog input.
Parameters	None
Returned Data Format	n/a
Query Example	SYST:AIO:IN1:OFFSET:DEF? 15.0
Query Format	<b>SYSTem:AIO:INput[n]:OFFSET:MAXimum?</b>
Description	Returns the maximum offset for the specified analog input.
Parameters	None
Returned Data Format	n/a
Query Example	SYST:AIO:IN1:OFFSET:MAX? 100000.000000
Query Format	<b>SYSTem:AIO:INput[n]:OFFSET:MINimum?</b>
Description	Returns the minimum offset for the specified analog input.
Parameters	None
Returned Data Format	n/a
Query Example	SYST:AIO:IN1:OFFSET:MIN? -100000.000000
Command Syntax	<b>SYSTem:AIO:INput[n]:RANGe &lt;nr2&gt;</b>
Description	Sets the range of the specified analog input. Available range is 0.0 ~ 10.
Parameters	Offset
Parameter Format	<nr2>
Example	SYST:AIO:IN1:RANG 50.0
Query Format	<b>SYSTem:AIO:INput[n]:RANGe?</b>
Returned Data Format	<nr2>
Query Example	SYST:AIO:IN1:RANG? 10.00

Query Format	<b>SYSTem:AIO:INput[n]:RANGe:DEFault?</b>
Description	Returns the default range for the specified analog input.
Parameters	None
Returned Data Format	n/a
Query Example	SYST:AIO:IN1:RANG:DEF? 0.0
Query Format	<b>SYSTem:AIO:INput[n]:RANGe:MAXimum?</b>
Description	Returns the maximum range for the specified analog input.
Parameters	None
Returned Data Format	n/a
Query Example	SYST:AIO:IN1:RANG:MAX? 10.0
Query Format	<b>SYSTem:AIO:INput[n]:RANGe:MINimum?</b>
Description	Returns the minimum range for the specified analog input.
Parameters	None
Returned Data Format	n/a
Query Example	SYST:AIO:IN1:RANG:MIN? 0.0
Query Format	<b>SYSTem:AIO:INput[n]:UNITs?</b>
Description	Returns the assigned unit for the specified analog input port.
Parameters	None
Returned Data Format	<cr>
Query Example	SYST:AIO:IN2:UNIT? Vrms
Query Format	<b>SYSTem:AIO:INput[n]:VOLTage?</b>
Description	Returns the voltage value at the specified analog input port.
Parameters	None
Returned Data Format	<nr2>
Query Example	SYST:AIO:IN2:VOLT? 4.895

### 8.10.1.2 SYSTem:AIO:OUTput

Command Syntax	<b>SYSTem:AIO:OUTput[n] &lt;cr&gt;</b>
Description	Sets the LSX measurement that is mapped to each analog output port.
Parameters	[ MEAS:CURR1?   MEAS:CURR2?   MEAS:CURR3?   MEAS:CURR:CREST1?   MEAS:CURR:CREST2?   MEAS:CURR:CREST3?   MEAS:CURR:CREST?   MEAS:CURR:DC1?   MEAS:CURR:DC2?   MEAS:CURR:DC3?   MEAS:CURR:DC?   MEAS:CURR:PEAK1?   MEAS:CURR:PEAK2?   MEAS:CURR:PEAK3?   MEAS:CURR:PEAK?   MEAS:CURR?   MEAS:FREQ?   MEAS:KVA1?   MEAS:KVA2?   MEAS:KVA3?   MEAS:KVA?   MEAS:PF1?   MEAS:PF2?   MEAS:PF3?   MEAS:PF?   MEAS:POW1?   MEAS:POW2?   MEAS:POW3?   MEAS:POW?   MEAS:VLL:AC1?   MEAS:VLL:AC2?   MEAS:VLL:AC3?   MEAS:VLL:AC?   MEAS:VLL:ACDC1?   MEAS:VLL:ACDC2?   MEAS:VLL:ACDC3?   MEAS:VLL:ACDC?   MEAS:VLL:DC1?   MEAS:VLL:DC2?   MEAS:VLL:DC3?   MEAS:VLL:DC?   MEAS:VOLT:AC1?   MEAS:VOLT:AC2?   MEAS:VOLT:AC3?   MEAS:VOLT:AC?   MEAS:VOLT:ACDC1?   MEAS:VOLT:ACDC2?   MEAS:VOLT:ACDC3?   MEAS:VOLT:ACDC?   MEAS:VOLT:DC1?   MEAS:VOLT:DC2?   MEAS:VOLT:DC3?   MEAS:VOLT:DC? ] See the “SYSTem:AIO:OUTput:CATalog?” command for a list of available parameters.
Parameter Format	<cr>
Example	SYST:AIO:OUT1 VRMS
Query Format	<b>SYSTem:AIO:OUTput[n]?</b>
Returned Data Format	<cr>
Query Example	SYST:AIO:OUTP? VRMS
Query Format	<b>SYSTem:AIO:OUTput:CATalog?</b>
Description	Returns list of available analog outputs
Returned Data Format	<cr>
Query Example	SYST:AIO:OUT:CAT? MEAS:CURR1?,MEAS:CURR2?,MEAS:CURR3?,MEAS:CURR:CREST1?,MEAS:CURR:CREST2?,MEAS:CURR:CREST3?,MEAS:CURR:CREST?,MEAS:CURR:DC1?,MEAS:CURR:DC2?,MEAS:CURR:DC3?,MEAS:CURR:DC?,MEAS:CURR:PEAK1?,MEAS:CURR:PEAK2?,MEAS:CURR:PEAK3?,MEAS:CURR:PEAK?,MEAS:CURR?,MEAS:FREQ?,MEAS:KVA1?,MEAS:KVA2?,MEAS:KVA3?,MEAS:KVA?,MEAS:PF1?,MEAS:PF2?,MEAS:PF3?,MEAS:PF?,MEAS:POW1?,MEAS:POW2?,MEAS:POW3?,MEAS:POW?,MEAS:VLL:AC1?,MEAS:VLL:AC2?,MEAS:VLL:AC3?,MEAS:VLL:AC?,MEAS:VLL:ACDC1?,MEAS:VLL:ACDC2?,MEAS:VLL:ACDC3?,MEAS:VLL:ACDC?,MEAS:VLL:DC1?,MEAS:VLL:DC2?,MEAS:VLL:DC3?,MEAS:VLL:DC?,MEAS:VOLT:AC1?,MEAS:VOLT:AC2?,MEAS:VOLT:AC3?,MEAS:VOLT:AC?,MEAS:VOLT:ACDC1?,MEAS:VOLT:ACDC2?,MEAS:VOLT:ACDC3?,MEAS:VOLT:ACDC?,MEAS:VOLT:DC1?,MEAS:VOLT:DC2?,MEAS:VOLT:DC3?,MEAS:VOLT:DC?



Command Syntax	<b>SYSTem:AIO:OUTput[n]:GAIN &lt;nr2&gt;</b>
Description	Sets the full-scale gain of the LSX measurement mapped to the analog input.
Parameters	Full scale value
Parameter Format	<nr2>
Example	SYST:AIO:OUT1:GAIN 230.0
Query Format	<b>SYSTem:AIO:OUTput[n]:GAIN?</b>
Returned Data Format	<nr2>
Query Example	SYST:AIO:OUT1:GAIN? 425.0000
Query Format	<b>SYSTem:AIO:OUTput[n]:GAIN:DEFault?</b>
Description	Returns the default full-scale gain for the specified analog output port.
Parameters	None
Returned Data Format	n/a
Query Example	SYST:AIO:OUT1:GAIN:DEF? 425.0000
Query Format	<b>SYSTem:AIO:OUTput[n]:GAIN:MAXimum?</b>
Description	Returns the maximum gain for the specified analog output port.
Parameters	None
Returned Data Format	n/a
Query Example	SYST:AIO:OUT1:GAIN:MAX? 100000.00000
Query Format	<b>SYSTem:AIO:OUTput[n]:GAIN:MINimum?</b>
Description	Returns the minimum gain for the specified analog output port.
Parameters	None
Returned Data Format	n/a
Query Example	SYST:AIO:OUT1:GAIN:MIN? -100000.00000
Command Syntax	<b>SYSTem:AIO:OUTput[n]:OFFSET &lt;nr2&gt;</b>
Description	Sets the offset of the specified analog output port.
Parameters	Offset
Parameter Format	<nr2>
Example	SYST:AIO:OUT1:OFFSET 50.0
Query Format	<b>SYSTem:AIO:OUTput[n]:OFFSET?</b>
Returned Data Format	<nr2>
Query Example	SYST:AIO:OUT1:OFFSET? 50.00

Query Format	<b>SYSTem:AIO:OUTput[n]:OFFSET:DEFault?</b>
Description	Returns the default offset for the specified analog output port.
Parameters	None
Returned Data Format	n/a
Query Example	SYST:AIO:OUT1:OFFSET:DEF? 0.00000
Query Format	<b>SYSTem:AIO:OUTput[n]:OFFSET:MAXimum?</b>
Description	Returns the maximum gain for the specified analog output port.
Parameters	None
Returned Data Format	n/a
Query Example	SYST:AIO:OUT1:GAIN:MAX? 100000.00000
Query Format	<b>SYSTem:AIO:OUTput[n]:OFFSET:MINimum?</b>
Description	Returns the minimum gain for the specified analog output port.
Parameters	None
Returned Data Format	n/a
Query Example	SYST:AIO:OUT1:GAIN:MIN? -100000.00000
Command Syntax	<b>SYSTem:AI:OUTput[n]:GAIN &lt;nr2&gt;</b>
Description	Sets the full-scale gain of the specified analog output port.
Parameters	Full scale value
Parameter Format	<nr2>
Example	SYST:AIO:OUT1:GAIN 230.0
Query Format	<b>SYSTem:AIO:OUTput[n]:GAIN?</b>
Returned Data Format	<nr2>
Query Example	SYST:AIO:OUT1:GAIN? 230.00
Query Format	<b>SYSTem:AIO:OUTput[n]:GAIN:DEFault?</b>
Description	Returns the default full-scale gain for the specified analog output.
Parameters	None
Returned Data Format	<nr2>
Query Example	SYST:AIO:OUT1:GAIN:DEF? 425.00000
Query Format	<b>SYSTem:AIO:OUTput[n]:GAIN:MAXimum?</b>
Description	Returns the maximum full-scale gain for the specified analog output.
Parameters	None
Returned Data Format	n/a
Query Example	SYST:AIO:OUT1:GAIN:MAX? 100000.00000

Query Format	<b>SYSTem:AIO:OUTput[n]:GAIN:MINimum?</b>
Description	Returns the minimum full-scale gain for the specified analog output.
Parameters	None
Returned Data Format	n/a
Query Example	SYST:AIO:OUT1:GAIN:MIN? -100000.00000

Query Format	<b>SYSTem:AIO:OUTput[n]:UNITs?</b>
Description	Returns the assigned unit for the specified analog output port.
Parameters	None
Returned Data Format	<cr>
Query Example	SYST:AIO:OUT2:UNIT? Vrms

Query Format	<b>SYSTem:AIO:OUTput[n]:VOLTage?</b>
Description	Returns the voltage at the analog output port.
Parameters	None
Returned Data Format	<nr2>
Query Example	SYST:AIO:OUT2:VOLT? 7.2590

#### 8.10.1.3 SYSTem:DIO:Input

Query Format	<b>SYSTem:DIO:INput[n]?</b>
Description	Queries status of Digital Input 1, 2 or 3. If I/O number is omitted, all three input values are returned. n = 1, 2 or 3.
Parameters	none
Returned Data Format	<cr>
Parameter Format	<nr1>
Query Example	SYST:DIO:IN2? 0

Command Syntax	<b>SYSTem:DIO:INput[n]:FALLing &lt;cr&gt;</b>
	<b>SYSTem:DIO:INput[n]:RISing &lt;cr&gt;</b>
Description	Sets the SCPI command to be executed at the rising or falling event of that digital input [n]. n = 1, 2 or 3.
Parameters	SCPI command string
Parameter Format	<cr>
Example	SYST:DIO:IN1:FALL "OUTP 0" SYST:DIO:IN1:RIS "OUTP 1" These settings will enable the output at the rising edge of the pulse and disable it at the falling edge.
Query Format	<b>SYSTem:DIO:INput[n]:FALLing?</b> <b>SYSTem:DIO:INput[n]:RISing?</b>
Returned Data Format	<cr>
Query Example	SYST:DIO:IN1:RIS? OUTP 1 SYST:DIO:IN1:FALL? -
Command Syntax	<b>SYSTem:DIO:INput[n]:FILtersize &lt;nr1&gt;</b>
Description	Defines the time in ms (milliseconds) that the digital input has to keep the state after a transition in order to generate the event. If filtersize is zero, then the event is immediately generated, otherwise the specified time will prevent short pulses from generating events. This is useful in noisy environments and also if the digital signal is controlled by a switch or a mechanical actuator.
Parameters	0 – 1000
Parameter Format	<nr1>
Example	SYST:DIO:IN1:FIL 8
Query Format	<b>SYSTem:DIO:INput[n]:FILtersize?</b>
Returned Data Format	<nr1>
Query Example	SYST:DIO:IN1:FIL? 8
Query Format	<b>SYSTem:DIO:INput[n]:FILtersize:DEFault?</b>
Description	Returns the default filter size value.
Returned Data Format	<nr1>
Query Example	SYST:DIO:IN1:FIL:DEF? 0
Query Format	<b>SYSTem:DIO:INput[n]:FILtersize:MAXimum?</b>
Description	Returns the maximum allowed filter size value.
Returned Data Format	<nr1>
Query Example	SYST:DIO:IN1:FIL:MAX? 1000

Query Format	<b>SYSTem:DIO:INput[n]:FILtersize:MINimum?</b>
Description	Returns the minimum allowed filter size value.
Returned Data Format	<nr1>
Query Example	SYST:DIO:IN1:FIL:MIN? 1

#### 8.10.1.4 SYSTem:DIO:OUTput

Command Syntax	<b>SYSTem:DIO:OUTput[n] &lt;MODE&gt;</b>
Description	Sets output value of digital output n. n = 1 or 2.
Parameter 1	MODE The mode determines when an output is generated. Available MODE settings are: <ul style="list-style-type: none"> <li>• 1, ON, 0, OFF it is used as general purpose output. [ 0   LOW   1   HIGH ]</li> <li>• OUTPUT_STATE indicates output enabled(1) or disabled(0).</li> <li>• FORM indicates single(1) or split/three(0).</li> <li>• FAULT indicates fault(1) or no fault(0).</li> <li>• TRANSIENT indicates when a transient is running/paused/stepping(1) or stopped(0).</li> <li>• PROGRAM indicates when a program is in execution at steady state level(1) or manual mode(0).</li> <li>• REMOTE indicates remote(1) or local(0) state</li> </ul> Defaults are: OUTPUT1:        OUTPUT_STATE OUTPUT2:        FORM
Parameter Format	<cr>
Example	SYST:DIO:OUT1 FAULT
Query Format	<b>SYSTem:DIO:OUTput[n]?</b>
Description	Returns settings for selected pin number n
Returned Data Format	<nr1>
Query Example	SYST:DIO:OUT1? OUTPUT STATE,NON-INVERTING
Query Format	<b>SYSTem:DIO:OUTput:CATalog?</b>
Description	Returns list of available digital outputs
Returned Data Format	<cr>
Query Example	SYST:DIO:OUT:CAT? COUPLING,FAULT,FORM,HIGH,LOW,OUTPUT STATE,PROGRAM,REMOTE,TRANSIENT

Command Syntax	<b>SYSTem:DIO:OUTput[n]:INVert</b>
Description	Inverts the logic polarity of the selected digital output.
Parameters	[ 0   NORMAL   1   INVERT ]
Example	SYST:DIO:OUT1 1
Query Format	<b>SYSTem:DIO:OUTput[n]:INVert?</b>
Description	Returns logic inversion setting
Returned Data Format	<nr1>
Query Example	SYST:DIO:OUT1:INV? 1

Query Format	<b>SYSTem:DIO:OUTput[n]:STATe?</b>
Description	Returns logic level of selected output pin.
Returned Data Format	<b>
Query Example	SYST:DIO:OUT1:STAT? 1

#### 8.10.1.5 SYSTem:DIO:REMOte

Command Syntax	<b>SYSTem:DIO:REMOte:ENABle &lt;b&gt;</b>
Description	Turns the remote enable state on or off
Parameters	< 0   OFF   1   ON >
Parameter Format	<b>
Example	SYST:DIO:REMOte:ENABle 1
Query Format	<b>SYSTem:DIO:REMOte:ENABle?</b>
Returned Data Format	<b>
Query Example	SYST:DIO:REM:ENA? 1

Command Syntax	<b>SYSTem:DIO:REMOte:INHibit &lt;b&gt;</b>
Description	Turns the remote inhibit state on or off
Parameters	< 0   OFF   1   ON >
Parameter Format	<b>
Example	SYST:DIO:REMOte:INHibit 1
Query Format	<b>SYSTem:DIO:REMOte:INHibit?</b>
Returned Data Format	<b>
Query Example	SYST:DIO:REM:INH? 1

### 8.10.1.6 SYSTem:DIO:STROBE

Command Syntax	<b>SYSTem:DIO:STROBE:OUTPustate &lt;b&gt;</b>
Description	Sets the function strobe mode active when the output relay changes state
Parameters	< 0   OFF   1   ON >
Parameter Format	<b>
Example	SYST:DIO:STROBE:OUTP 1
Query Format	<b>SYSTem:DIO:STROBE:OUTPustate?</b>
Returned Data Format	<b>
Query Example	SYST:DIO:STROBE:OUTP? 1
Command Syntax	<b>SYSTem:DIO:STROBE:SOURce &lt;b&gt;</b>
Description	Sets the function strobe mode to program changes.
Parameters	< 0   OFF   1   ON >
Parameter Format	<b>
Example	SYST:DIO:STROBE:SOUR 1
Query Format	<b>SYSTem:DIO:STROBE:SOURce?</b>
Returned Data Format	<b>
Query Example	SYST:DIO:STROBE:SOUR? 1
Command Syntax	<b>SYSTem:DIO:STROBE:TRANsient&lt;b&gt;</b>
Description	Sets the function strobe mode to generate an output at the start of a transient execution.
Parameters	< 0   OFF   1   ON >
Parameter Format	<b>
Example	SYST:DIO:STROBE:TRAN 1
Query Format	<b>SYSTem:DIO:STROBE:TRANsient?</b>
Returned Data Format	<b>
Query Example	SYST:DIO:STROBE:TRAN? 1

## 8.10.2 SOURce:SYNChronize Commands

```
SOURce:SYNChronize
    [:INput][?]
        :PHASEshift[?]
        :RANGE[?]
        :SOURCE[?]
        :SPeed[?]
        :STATe?
```

```
SOURce:SYNChronize
    :OUTPut[?]
```

### 8.10.2.1 SOURce:SYNChronize[:INput]

Command Syntax	<b>SOURce:SYNChronize[:INput]</b>
Description	This command enables or disables the external sync input mode.
Parameters	[ 0   OFF   1   ON ]
Parameter Format	<b>
Example	SOUR:SYNC 1
Query Format	<b>SOURce:SYNChronize[:INput]?</b>
Returned Data Format	<b>
Query Example	SOUR:SYNC? 1

Command Syntax	<b>SOURce:SYNChronize[:Input]:PHASEshift &lt;nr2&gt;</b>
Description	Defines a fixed phase shift between phase A waveform generation and the external sync source. Used to calibrate any phase difference between the sync signal and the power source output on phase A.
Parameters	Phase shift
Parameter Format	<nr>
Example	SOUR:SYNC:PHASE 2.8
Query Format	<b>SOURce:SYNChronize[:Input]:PHASEshift?</b>
Returned Data Format	<nr2>
Query Example	SOUR:SYNC:PHASE? 0.5



<p>Command Syntax Description</p>	<p><b>SOURce:SYNChronize[:Input]:RANGe &lt;nr2&gt;</b> Allows configuration of how much the synchronization engine is able to deviate from the LSX programmed frequency. This helps to keep the waveform frequency under control, even if the external source is not present all the time. The synchronization engine is limited to frequencies of FSETPOINT +/- FRANGE.</p>
<p>Parameters Parameter Format Example Query Format Returned Data Format Query Example</p>	<p>Range in Hz &lt;nr2&gt; SOUR:SYNC:RANG 5.0 <b>SOURce:SYNChronize[:Input]:RANGe?</b> &lt;nr2&gt; SOUR:SYNC:RANGe? 10.000</p>
<p>Command Syntax Description</p>	<p><b>SOURce:SYNChronize[:Input]:SOURce &lt;cr&gt;</b> This command selects either the external sync TTL (1) or the internal AC line sync (0) mode (not available on LSX models). A phase adjustment for Phase A output will be needed using the SOURce:SYNChronize[:Input]:PHASEshift command.</p>
<p>Parameters Parameter Format Example Query Format Returned Data Format Query Example</p>	<p>[ 0   AC   1   TTL ] &lt;cr&gt; SOUR:SYNC:SOUR TTL <b>SOURce:SYNChronize[:Input]:SOURce?</b> &lt;cr&gt; SOUR:SYNC:SOUR? 1</p>
<p>Command Syntax Description</p>	<p><b>SOURce:SYNChronize[:Input]:SPeed &lt;nr2&gt;</b> Allows accelerating the speed of the internal synchronization engine (PLL) in case the external sync source is not constant and presents periodic or continuous changes. A slower speed improves the stability of the waveform frequency, so it is recommended to keep use the smallest possible speed values.</p>
<p>Parameters Parameter Format Example Query Format Returned Data Format Query Example</p>	<p>Speed (multiplier value) &lt;nr1&gt; Range is 1.000 ~ 10.000 SOUR:SYNC:SP 0.50 <b>SOURce:SYNChronize[:Input]:SPeed?</b> &lt;nr2&gt; SOUR:SYNC:SP? 2.500</p>

---

Query Command	<b>SOURce:SYNChronize[:Input]:STATe?</b>
Description	This query only command returns the status of the Phase Lock Loop (PLL). A "0" response indicates the PLL has not locked on to the sync input yet. A 1 response indicates the PLL is locked.
Returned Data Format	<b>
Returned Data	0 = PLL is not locked 1 = PLL is locked
Query Example	SOUR:SYNC:STAT? 1

#### 8.10.2.2 SOURce:SYNChronize[:OUTput]

Command Syntax	<b>SOURce:SYNChronize:OUTput</b>
Description	This command enables the SYNC output
Query Format	<b>SOURce:SYNChronize:OUTput?</b>
Returned Data Format	<b>
Returned Data	0 = SYNC output off 1 = SYNCoutput on
Query Example	SOUR:SYNC:OUT? 1

### 8.10.3 PROGram:TRANSient Triggers Commands

```
PROGram:TRANSient:TRIGger
    :Input[?]
        :IMMEDIATE[?]
        :AUTOrun[?]
    :OUTput[?]
```

#### 8.10.3.1 PROGram:TRANSient

The following **PROGram:TRANSient:TRIGger** commands are available.

Command Syntax	<b>PROGram:TRANSient:TRIGger:INput</b>
Description	When the trigger input is active, this command selects the trigger input source mode as on or off. When ON, the external trigger input is enabled.
Parameters	[ 0   OFF   1   ON ]
Parameter Format	<b>
Example	PROG:TRAN:TRIG:IN 1
Query Format	<b>PROGram:TRANSient:TRIGger:INput?</b>
Returned Data Format	<b>
Query Example	PROG:TRAN:TRIG:IN? 1

Command Syntax	<b>PROGram:TRANSient:TRIGger:INput:IMMEDIATE &lt;b&gt;</b>
Description	When the trigger input is active, this command starts the transient segments immediately after the trigger input is received, without waiting for the zero crossing, as determined by the update phase setting. Refer to SOURce:UPDATEPHase
Parameters	[ 0   OFF   1   ON ]
Parameter Format	<b>
Example	PROG:TRAN:TRIG:IN:IMM 1
Query Format	<b>PROGram:TRANSient:TRIGger:INput:IMMEDIATE?</b>
Returned Data Format	<b>
Query Example	PROG:TRAN:TRIG:IN:IMM? 1

Command Syntax Description	<b>PROG:TRANSient:TRIGger:INput:AUTOrun &lt;b&gt;</b> When the trigger input is active and segments are running state, each trigger event (pulse) will automatically start a new sequence, without the need of a new RUN command before each trigger. The RUN command has to be executed only once, and then each subsequent trigger input event will cause a new segment sequence to run. <b>Note:</b> the trigger signal is level-sensitive; hence if it is kept high, it will continuously issue a trigger.
Parameters Parameter Format Example Query Format Returned Data Format Query Example	[ 0   OFF   1   ON ] <b> PROG:TRAN:TRIG:IN:AUTO 1 <b>PROG:TRANSient:TRIGger:INput:AUTOrun?</b> <b> PROG:TRAN:TRIG:IN:AUTO? 1
Command Syntax Description	<b>PROG:TRANSient:TRIGger:OUTput</b> This command causes a trigger output pulse to be generated when a transient execution is started. Note that this output is used as a function strobe during steady state operation.
Parameters Parameter Format Example Query Format Returned Data Format Query Example	[ 0   OFF   1   ON ] <b> PROG:TRAN:TRIG:OUT 1 <b>PROG:TRANSient:TRIGger:OUTput?</b> <b> PROG:TRAN:TRIG:OUT? 1

### 8.10.4 Analog Input Commands

These commands control the use of analog input signals to drive the output of the LSX power source. These functions are comparable to those of the legacy AMX Series power sources.

```
[SOURce:]ANalog:PROGramming#
[:MODE] [ 0 | OFF | 1 | AMP | 2 | AM | 3 | ADD ]
[:MODE]?
[:AMP]                Applies to AMP and ADD modes
    :OFFset
        :DEFault?
        :MAXimum?
        :MINimum?
    :OFFset?
:AM                    Applies to AM mode
    :GAIN
        :DEFault?
        :MAXimum?
        :MINimum?
    :GAIN?
:HPF
    :STATe
    :STATe?
    :FREQuency
        :DEFault?
        :MAXimum?
        :MINimum?
    :FREQuency?
```

#### 8.10.4.1 Analog Input Mode Commands

Change between off, amplifier mode, AM or addition to internal waveform.

Available modes:

Value	Mode
0   OFF	Input disabled
1   AMP	Amplifier Mode
2   AM	Amplitude Modulation mode
3   ADD	Addition or Summing mode

```
[SOURce:]ANalog:PROGramming#[:MODE] 0,1,2,3/OFF,AMP,AM,ADD
[SOURce:]ANalog:PROGramming#[:MODE]?
```

#### 8.10.4.2 Analog Input Gain & Offset Commands

Change gain for amplifier and addition modes (default=250\*xfmr-ratio)

```
[SOURCE:]ANalog:PROGramming#[:AMP]:GAIN
[SOURCE:]ANalog:PROGramming#[:AMP]:GAIN?
[SOURCE:]ANalog:PROGramming#[:AMP]:GAIN:DEFault?
[SOURCE:]ANalog:PROGramming#[:AMP]:GAIN:MAXimum?
[SOURCE:]ANalog:PROGramming#[:AMP]:GAIN:MINimum?
```

Change offset of input signal (default = 0.0), useful for unipolar input signals:

```
[SOURCE:]ANalog:PROGramming#[:AMP]:OFFset
[SOURCE:]ANalog:PROGramming#[:AMP]:OFFset?
[SOURCE:]ANalog:PROGramming#[:AMP]:OFFset:DEFault?
[SOURCE:]ANalog:PROGramming#[:AMP]:OFFset:MAXimum?
[SOURCE:]ANalog:PROGramming#[:AMP]:OFFset:MINimum?
```

Change gain for AM (=1.0 or 100% by default)

```
[SOURCE:]ANalog:PROGramming#:AM:GAIN
[SOURCE:]ANalog:PROGramming#:AM:GAIN?
[SOURCE:]ANalog:PROGramming#:AM:GAIN:DEFault?
[SOURCE:]ANalog:PROGramming#:AM:GAIN:MAXimum?
[SOURCE:]ANalog:PROGramming#:AM:GAIN:MINimum?
```

Change offset for AM (default = 0)

```
[SOURCE:]ANalog:PROGramming#:AM:OFFset
[SOURCE:]ANalog:PROGramming#:AM:OFFset?
[SOURCE:]ANalog:PROGramming#:AM:OFFset:DEFault?
[SOURCE:]ANalog:PROGramming#:AM:OFFset:MAXimum?
[SOURCE:]ANalog:PROGramming#:AM:OFFset:MINimum?
```

#### 8.10.4.3 High Pass Filter Commands

Enable/Disable high pass filter at the analog programming, to block the DC (this may not be very relevant for AC coupled sources, but it has an effect in AM), disabled by default.

```
[SOURCE:]ANalog:PROGramming#:HPF:STATE      [ 0 | OFF | 1 | ON ]
[SOURCE:]ANalog:PROGramming#:HPF:STATE?
```

Change frequency of HPF (10Hz by default)

```
[SOURCE:]ANalog:PROGramming#:HPF:FREQuency
[SOURCE:]ANalog:PROGramming#:HPF:FREQuency?
[SOURCE:]ANalog:PROGramming#:HPF:FREQuency:DEFault?
[SOURCE:]ANalog:PROGramming#:HPF:FREQuency:MAXimum?
[SOURCE:]ANalog:PROGramming#:HPF:FREQuency:MINimum?
```

### 8.10.5 AUX I/O Calibration Commands

```

SYSTem:AIO
  :INPut#
    :CALibration
      :GAIN{?}
        :DEFault{?}
        :MAXimum
        :MINimum
      :OFFset{?}
        :DEFault{?}
        :MAXimum
        :MINimum
  :OUTput#
    :CALibration
      :GAIN{?}
        :DEFault{?}
        :MAXimum
        :MINimum
      :OFFset{?}
        :DEFault{?}
        :MAXimum
        :MINimum
  
```

#### 8.10.5.1 SYSTem:AIO:INPut#:CALibration

Command Syntax	<b>SYSTem:AIO:INput[n]:CALibration:GAIN &lt;nr2&gt;</b>
Description	Calibrates the full scale gain of the LSX parameter controlled by the analog input.
Parameters	Reference
Parameter Format	<nr2>
Example	SYST:AIO:IN1:CAL:GAIN 100.0
Query Format	<b>SYSTem:AIO:INput[n]:CALibration:GAIN?</b>
	Returns calibration coefficient
Returned Data Format	<nr2>
Query Example	SYST:AIO:IN1:CAL:GAIN? 1.000
Query Command	<b>SYSTem:AIO:INput[n]:CALibration:GAIN:DEFault?</b>
	Returns default calibration coefficient value
Returned Data Format	<nr2>
Query Example	SYST:AIO:IN1:CAL:GAIN:DEF? 1.000
Query Command	<b>SYSTem:AIO:INput[n]:CALibration:GAIN:MAXimum?</b>
	Returns upper limit of calibration coefficient value
Returned Data Format	<nr2>
Query Example	SYST:AIO:IN1:CAL:GAIN:MAX? 1.000

Query Command	<b>SYSTem:AIO:INput[n]:CALibration:GAIN:MINimum?</b> Returns lower limit of calibration coefficient value
Returned Data Format	<nr2>
Query Example	SYST:AIO:IN1:CAL:GAIN:MIN? 0.000
Command Syntax Description	<b>SYSTem:AIO:INput[n]:CALibration:OFFset &lt;nr2&gt;</b> Calibrates the full scale gain of the LSX parameter controlled by the analog input.
Parameters	Reference
Parameter Format	<nr2>
Example	SYST:AIO:IN1:CAL:OFF 0.01
Query Format	<b>SYSTem:AIO:INput[n]:CALibration:OFFset?</b> Returns calibration coefficient
Returned Data Format	<nr2>
Query Example	SYST:AIO:IN1:CAL:OFF? 0.010
Query Command	<b>SYSTem:AIO:INput[n]:CALibration:OFFset:DEFault?</b> Returns default calibration coefficient value
Returned Data Format	<nr2>
Query Example	SYST:AIO:IN1:CAL:OFF:DEF? 1.000
Query Command	<b>SYSTem:AIO:INput[n]:CALibration:OFFset:MAXimum?</b> Returns upper limit of calibration coefficient value
Returned Data Format	<nr2>
Query Example	SYST:AIO:IN1:CAL:OFF:MAX? 1.000



Query Command      **SYSTem:AIO:INput[n]:CALibration:OFFset:MINimum?**  
Returns lower limit of calibration coefficient value

Returned Data Format      <nr2>

Query Example      SYST:AIO:IN1:CAL:OFF:MIN?  
1.000

#### 8.10.5.2 SYSTem:AIO:OUTput#:CALibration

Command Syntax      **SYSTem:AIO:OUTput[n]:CALibration:GAIN <nr2>**  
Description      Calibrates the full scale gain of the LSX parameter controlled by the analog output.

Parameters      Reference

Parameter Format      <nr2>

Example      SYST:AIO:OUT1:CAL:GAIN 100.0

Query Format      **SYSTem:AIO:OUTput[n]:CALibration:GAIN?**  
Returns calibration coefficient

Returned Data Format      <nr2>

Query Example      SYST:AIO:OUT1:CAL:GAIN?  
1.000

Query Command      **SYSTem:AIO:OUTput[n]:CALibration:GAIN:DEFault?**  
Returns default calibration coefficient value

Returned Data Format      <nr2>

Query Example      SYST:AIO:OUT1:CAL:GAIN:DEF?  
1.000

Query Command      **SYSTem:AIO:OUTput[n]:CALibration:GAIN:MAXimum?**  
Returns upper limit of calibration coefficient value

Returned Data Format      <nr2>

Query Example      SYST:AIO:OUT1:CAL:GAIN:MAX?  
1.000

Query Command      **SYSTem:AIO:OUTput[n]:CALibration:GAIN:MINimum?**  
Returns lower limit of calibration coefficient value

Returned Data Format      <nr2>

Query Example      SYST:AIO:OUT1:CAL:GAIN:MIN?  
0.000

Command Syntax	<b>SYSTem:AIO:OUTput[n]:CALibration:OFFset &lt;nr2&gt;</b>
Description	Calibrates the full scale gain of the LSX parameter controlled by the analog output.
Parameters	Reference
Parameter Format	<nr2>
Example	SYST:AIO:OUT1:CAL:OFF 0.01
Query Format	<b>SYSTem:AIO:OUTput[n]:CALibration:OFFset?</b>
	Returns calibration coefficient
Returned Data Format	<nr2>
Query Example	SYST:AIO:OUT1:CAL:OFF? 0.010
Query Command	<b>SYSTem:AIO:OUTput[n]:CALibration:OFFset:DEFault?</b>
	Returns default calibration coefficient value
Returned Data Format	<nr2>
Query Example	SYST:AIO:OUT1:CAL:OFF:DEF? 1.000
Query Command	<b>SYSTem:AIO:OUTput[n]:CALibration:OFFset:MAXimum?</b>
	Returns upper limit of calibration coefficient value
Returned Data Format	<nr2>
Query Example	SYST:AIO:OUT1:CAL:OFF:MAX? 1.000
Query Command	<b>SYSTem:AIO:OUTput[n]:CALibration:OFFset:MINimum?</b>
	Returns lower limit of calibration coefficient value
Returned Data Format	<nr2>
Query Example	SYST:AIO:OUT1:CAL:OFF:MIN? 1.000

## 8.11 Test Sequence Commands

The following SCPI commands are available to control Power source embedded Test Sequence operation from an user ATE test program. **Note** that the Test Sequence functionality requires power source firmware revision 3.7.0 or higher.

Command Syntax	<b>TSEquence:CATalog?</b>
Description	Returns a comma-separated list of available sequences files. The query can be customized with the type of memory, OFFSET to determine start index, and LENGTH to define the number of results. <OPT: MEMORY, OPT: OFFSET, OPT: LENGTH>
Parameters	Memory types: INTERNAL   RAM INTERNAL = Internal Flash Memory. (Default selection) RAM = Internal RAM. Content will be lost when power source is turned off.
Parameter Format	<cr>, <nr1>, <nr1>
Returned Data Format	<cr>
Example	TSEQ:CAT? 1,"4-11-Dips-Class2-Test.7z",2,"4-11-Dips-Class3-Test.7z",3,"4-11-Short-Interruptions-Test.7z",4,"4-11-Vars-Test.7z" TSEQ:CAT? RAM 1,"TestExample.7z" TSEQ:CAT? INTERNAL, 3, 4 3,"4-11-Short-Interruptions-Test.7z",4,"4-11-Vars-Test.7z"
Command Syntax	<b>TSEquence:SElect</b>
Description	This command selects a sequence file by name or number.
Parameters	<REQ: FILE STRING   FILE NUMBER, OPT: MEMORY> Memory types: INTERNAL   RAM INTERNAL = Internal Flash Memory. (Default selection) RAM = Internal RAM. Content will be lost when power source is turned off.
Parameter Format	<cr> or <nr1>, <cr>
Example	TSEQ:SEL "TestExample.7z", RAM TSEQ:SEL 3, INTERNAL TSEQ:SEL 1
Query Format	<b>TSEquence:SElected?</b>
Returned Data Format	<cr>
Query Example	TSEQ:SEL? "4-11-Short-Interruptions-Test"
Command Syntax	<b>TSEquence:CONTRol</b>
Description	This command controls sequence execution
Parameters	<RUN PAUSE STOP STEP REStart PASS FAIL CLEAR> RUN: to start the execution from the last selected step PAUSE: to pause the execution, only available when the sequence state is running. STOP: to stop the execution. STEP: to execute only the selected step. REST: to restart all progress and test execution.

	<p>PASS: to pass the current step in execution.          FAIL: to fail the current step in execution and stop the sequence progress.          CLEAR: to clear all logs and remove currently selected sequence from the execution panel.</p>
Parameter Format Example	<p>&lt;cr&gt;          TSEQ:CON RUN          TSEQ:CON PASS          TSEQ:CON CLEAR</p>
Command Syntax Description	<p><b>TSEquence:STATUS?</b>          This command returns sequence execution status, where:          NUMBER: &lt;nr1&gt;. Current step number. Example: 1          PROGRESS: &lt;nr1&gt;. Current step progress. &lt;0&gt; to &lt;100&gt;          STATUS: &lt;cr&gt;. Current state of the step execution:          "0-SKIPPED"          "1-PASSED"          "2-FAILED"          "3-STOPPED"          "4-RUNNING"          "5-PAUSED"          DESCRIPTION: &lt;cr&gt;. Current step description. Example: "User Input"          INSTRUCTION: &lt;cr&gt;. Returns TRUE if there is pending user input.  <b>Note:</b> When an instruction is pending, some commands will not be available, for example: TSEQ:STEP:GOTO or TSEQ:CON RUN</p>
Parameters	None
Returned Data Format	<cr>
Query Example	<p>TSEQ:STAT?          NUMBER,1,PROGRESS,0,STATUS,"4-RUNNING",DESCRIPTION,"Configuration",INSTRUCTION,TRUE</p>
Command Syntax Description	<p><b>TSEquence:Input</b>          This command allows to enter the necessary parameter when the instruction status is pending (INSTRUCTION, TRUE).</p>
Parameters	<p>&lt;REQ: VARIABLE STRING   INPUT NUMBER, REQ: VALUE STRING&gt;          Where input number is the index obtained using TSEQ:IN?. In addition, it is possible to enter each entry with its respective variable name.</p>
Parameter Format Example	<p>&lt;cr&gt; or &lt;nr1&gt;, &lt;cr&gt;          TSEQ:IN "IEC61000_4_11_UUT_SN", "00024"          TSEQ:IN "IEC61000_4_11_COMPANY", "PPST"          TSEQ:IN 3, "PPST"</p>
Query Format	<b>TSEquence:INput?</b>
Returned Data Format	<cr>
Query Example	<p>TSEQ:IN?          1,INPUT,"UUT Part Number",VARIABLE,"IEC61000_4_11_UUT_PN",VALUE,"1",2,INPUT,"UUT Serial Number",VARIABLE,"IEC61000_4_11_UUT_SN",VALUE,"00024",3,INPU</p>

T,"Company  
 Name",VARIABLE,"IEC61000\_4\_11\_COMPANY",VALUE,"",4,INPUT,"Test  
 Operator",VARIABLE,"IEC61000\_4\_11\_TECH",VALUE,"",5,INPUT,"UUT  
 Mode of  
 Operation",VARIABLE,"IEC61000\_4\_11\_UUT\_OP\_MODE",VALUE,""

Command Syntax	<b>TSEquence:RESULT?</b>
Description	Returns a comma-separated list of all steps in the sequence with their respective status.
Parameters	None
Parameter Format	n/a
Returned Data Format	<cr>
Example	TSEQ:RES? 1,PASSED,2,PASSED,3,SKIPPED,4,STOPPED,5,-,6,-,7,-,8,-,9,-,10,-,11,- ,12,-,13,-,14,-,15,-,16,-,17,-,18,-,19,-,20,-,21,-,22,-,23,-,24,-,25,-

Command Syntax	<b>TSEquence:STEP:GOTO</b>
Description	This command moves the execution cursor to the argument of the element passed.
Parameters	<REQ: STEP NUMBER>
Parameter Format	<nr1>
Returned Data Format	n/a
Query Example	TSEQ:STEP:GOTO 1 TSEQ:STEP:GOTO 3 TSEQ:STEP:GOTO 10

## 8.12 IEEE488.2 Common Commands

The following IEEE488.2 common commands (a.k.a. star commands) are supported by the AC power source. These commands are provided for compatibility with the IEEE488.2 standard. They are aliases to the relevant proprietary command and can be used interchangeably. Commands are shown in alphabetical order.

IEEE488.2 Command	Description	Group	Mandatory
*CLS	Clear Status	Status and Event	Yes
*DCL	Device Clear	Internal Operations	
*ESE <n>	Event Status Register Enable	Status and Event	Yes
*ESE?	ESE Query	Status and Event	Yes
*ESR?	Event Status Register Query	Status and Event	Yes
*GTL	Goto Local	Control	
*IDN?	Identify	System Data	Yes
*LLO	Local Lock Out	Control	Yes
*OPC	Operation Complete	Synchronization	Yes
*OPC?	OPC Status Query	Synchronization	Yes
*PSC	Power On Status Clear	Status and Event	
*PSC?	PSC Query	Status and Event	
*RST	Reset	Internal Operations	Yes
*SRE	Service Request Enable	Status and Event	Yes
*SRE?	SRE Query	Status and Event	Yes
*STB?	Status Byte Query	Status and Event	Yes
*TRG	Trigger	Synchronization	
*WAI	Wait	Synchronization	Yes

Table 8-3: Mandatory IEEE488.2 Common Commands

Command Syntax	<b>*CLS</b>
Description	Clear Status. The Clear Status (CLS) command clears the status byte by emptying the error queue and clearing all the event registers including the Data Questionable Event Register, the Standard Event Status Register, the Standard Operation Status Register and any other registers that are summarized in the status byte.

Command Syntax	<b>*DCL</b>
Description	Device Clear. Resets the instrument to a default state.
Parameters	None
Parameter Format	n/a

<p>Command Syntax Description</p>	<p><b>*ESE&lt;nr1&gt;</b> Selects the desired bits from the standard event status enable register. The variable &lt;nr1&gt; represents the sum of the bits that will be enabled. This register monitors I/O errors and synchronization conditions such as operation complete, request control, query error, device dependent error, status execution error, command error and power on. The selected bits are OR'd to become a summary bit (bit 5) in the byte register which can be queried. The setting by this command is not affected by *RST. However, cycling the power will reset this register to zero. Refer to section 8.12 for register bit values.</p>
<p>Parameters Parameter Format Example Query Format Returned Data Format Query Example</p>	<p>Range 0-255 &lt;nr1&gt; *ESE 128 <b>*ESE?</b> &lt;nr1&gt; *ESE? 193</p>
<p>Query Format Description</p>	<p><b>*ESR?</b> Event Status Register Query. Reads the contents of the Status Event Register (ESR). After this query, the content of the ESR register is reset. Refer to section 8.12 for register bit values.</p>
<p>Returned Data Format Query Example</p>	<p>&lt;nr1&gt; *ESR? 0</p>
<p>Command Syntax Description Returned Data Format Query Example</p>	<p><b>*GTL</b> Goto Local. Releases lock of front panel controls. N/A N/A</p>
<p>Query Format Description</p>	<p><b>*IDN?</b> Identification Query. Returns the unit's Identity string. The IDN string response contains several fields separated by a comma. <i>Query response:</i> Manufacturer, model, serial number, firmware revision.</p>
<p>Returned Data Format Query Example</p>	<p>&lt;cr&gt;,&lt;cr&gt;,&lt;nr1&gt;,&lt;nr2&gt; *IDN? PPSC,360LSX-4,106378889,2.0.0</p>
<p>Command Syntax Description Parameters Parameter Format</p>	<p><b>*LLO</b> Local Lock out. Locks out front panel LOCAL function. None n/a</p>

<p>Command Syntax Description</p>	<p><b>*OPC</b> The Operation Complete (OPC) command sets bit 0 in the Standard Event Status Register when all pending operations have finished. Optional: &lt; BLOCK   0   NOBLOCK   1&gt; <b>*OPC</b> <b>*OPC? &lt; BLOCK   0   NOBLOCK   1&gt;</b> IEEE488.2 standard command. The parameter is optional. The argument is optional, if it is not sent:</p> <ul style="list-style-type: none"> <li>• In UPC compatible mode default argument will be NONBLOCK or 1.</li> <li>• In normal mode default argument will be BLOCK or 0.</li> </ul>
<p>Parameters Example Query Format Description</p>	<p><b>*OPC? BLOCK   0</b> Returns 1 when all pending overlapped operations have been completed. It can be used to cause the controller to wait for commands to complete. <b>*OPC? NOBLOCK   1</b> Returns 1 if all pending overlapped operations have been completed or 0 if there are pending overlapped operations. It will <b>not</b> cause the controller to wait for commands to complete. Pending overlapped operations can be a transient or a soft start using ramp time/slew rates.</p>
<p>Returned Data Format Query Example</p>	<p>&lt;b&gt; <b>*OPC?</b> 1</p>
<p>Command Syntax Description</p>	<p><b>*PSC &lt;b&gt;</b> The Power-On Status Clear (PSC) command controls the automatic power-on clearing of the Service Request Enable Register, the Standard Event Status Enable Register, and device-specific event enable registers. ON(1) This choice enables the power-on clearing of the listed registers. OFF(0) This choice disables the clearing of the listed registers and they retain their status when a power-on condition occurs.</p>
<p>Parameters Parameter Format Example Query Format Returned Data Format Query Example</p>	<p>&lt; 0   OFF   1   ON &gt; &lt;b&gt; <b>*PSC 1</b> <b>*PSC?</b> &lt;b&gt; <b>*PSC?</b> 1</p>



Command Syntax Description	<p><b>*RST</b> RESET. The *RST command (reset) has the same effect as an IEEE-488 Device Clear bus command but can be used over the RS232C, USB or LAN interface as well. This command resets the unit to its power on default state. User defined waveforms or programs are not erased but the mode is set to manual and the transient list table is cleared. (Unless there is a power-on program configured using the <b>[SOURCE:]INITIAL</b> command) <i>Note: A reset cycle of the power source can take up to 20 seconds to complete. When developing test programs, allow this time to pass before sending other commands. Adjust interface time-out settings as needed.</i></p>																				
Parameters	None																				
Parameter Format	n/a																				
RESET STATE	<table border="0"> <tr> <td>FORM</td> <td>3</td> <td>VOLT:MODE</td> <td>AC</td> </tr> <tr> <td>VOLT:AC</td> <td>0.0000</td> <td>COUPLING</td> <td>DC</td> </tr> <tr> <td>VOLT:DC</td> <td>0.0000</td> <td>RANGE</td> <td>AC</td> </tr> <tr> <td>CURR:AC</td> <td>41.6667</td> <td></td> <td></td> </tr> <tr> <td>CURR:DC</td> <td>20.8333</td> <td></td> <td></td> </tr> </table>	FORM	3	VOLT:MODE	AC	VOLT:AC	0.0000	COUPLING	DC	VOLT:DC	0.0000	RANGE	AC	CURR:AC	41.6667			CURR:DC	20.8333		
FORM	3	VOLT:MODE	AC																		
VOLT:AC	0.0000	COUPLING	DC																		
VOLT:DC	0.0000	RANGE	AC																		
CURR:AC	41.6667																				
CURR:DC	20.8333																				
Command Syntax Description	<p><b>*SRE &lt;nr1&gt;</b> Before reading a status register, bits must be enabled. This command enables bits in the service request register. The current setting is saved in non-volatile memory.</p>																				
Parameters	0-255																				
Parameter Format	<nr1>																				
Example	*SRE 255																				
Query Format	<b>*SRE?</b>																				
Description	Reads the current state of the service request enable register. The register is cleared after reading it. Refer to section 8.12 for register bit values.																				
Returned Data Format	<nr1>																				
Query Example	*SRE? 255																				
Query Format Description	<p><b>*STB?</b> Status Byte Query. The *STB? query returns the contents of the status byte register (STB). After this query, the content of the STB register is reset. Refer to section 8.12 for register bit values.</p>																				
Returned Data Format	<nr1>																				
Query Example	*STB? 4																				
Command Syntax Description	<p><b>*TRG</b> Triggers pending operation.</p>																				
Parameters	None																				
Parameter Format	n/a																				

Command Syntax Description	<b>*WAI</b> Prohibits the instrument from executing any new commands until all pending overlapped commands have been completed.
Parameters	None
Parameter Format	n/a

## 8.13 Status and Events Registers

The IEEE488.2 standard defines a standardized status and events register system. Refer to the ANSI/IEEE-488.2 1987 standard for more information. This section provides an overview of these registers and bit positions for various status and error events.

### 8.13.1 Status Byte Register (STB)

The status register content is returned on a \*STB? query. It contains 8 bits as shown in the table below. The return value represents the 8 bits positions and can range from 0-255. A \*CLS command will clear the Status Byte Register (STB) and the Event Status Register (ESR). Refer to Figure 8-2, "Status Byte Logical Model".

BIT	NAME	DEFINITION
7	SOS	:STATus:OPERation register bit summary
6	MSS/RQS	- MASTER SUMMARY summarizes all STATUS BYTE bits (except bit 6) for *STB?, or, - REQUEST SERVICE indicates this device requested service when a Serial Poll was performed.
5	ESB	STANDARD EVENT STATUS REGISTER bit summary
4	MAV	MESSAGE AVAILABLE indicates Query response data is available
3	SQS	:STATus:QUESTionable register bit summary
2	EEQ	ERROR/EVENT QUEUE indicates an SCPI Error/Event message is available
1	BUSY	indicates UPC front panel not in V/I mode
0	FAULT	indicates Power Source FAULT

Table 8-4: Status Byte Register (STB)

**Note:** Setting a SERVICE REQUEST ENABLE (SRE) bit true unmask the STATUS bit in the STB. Bit 6 of the SRE is not applicable as the MASTER SUMMARY bit of the STB cannot be masked. The STB, SRE, ESR and ESE registers are 8 bits each.

The status byte logical model is shown in the figure below.

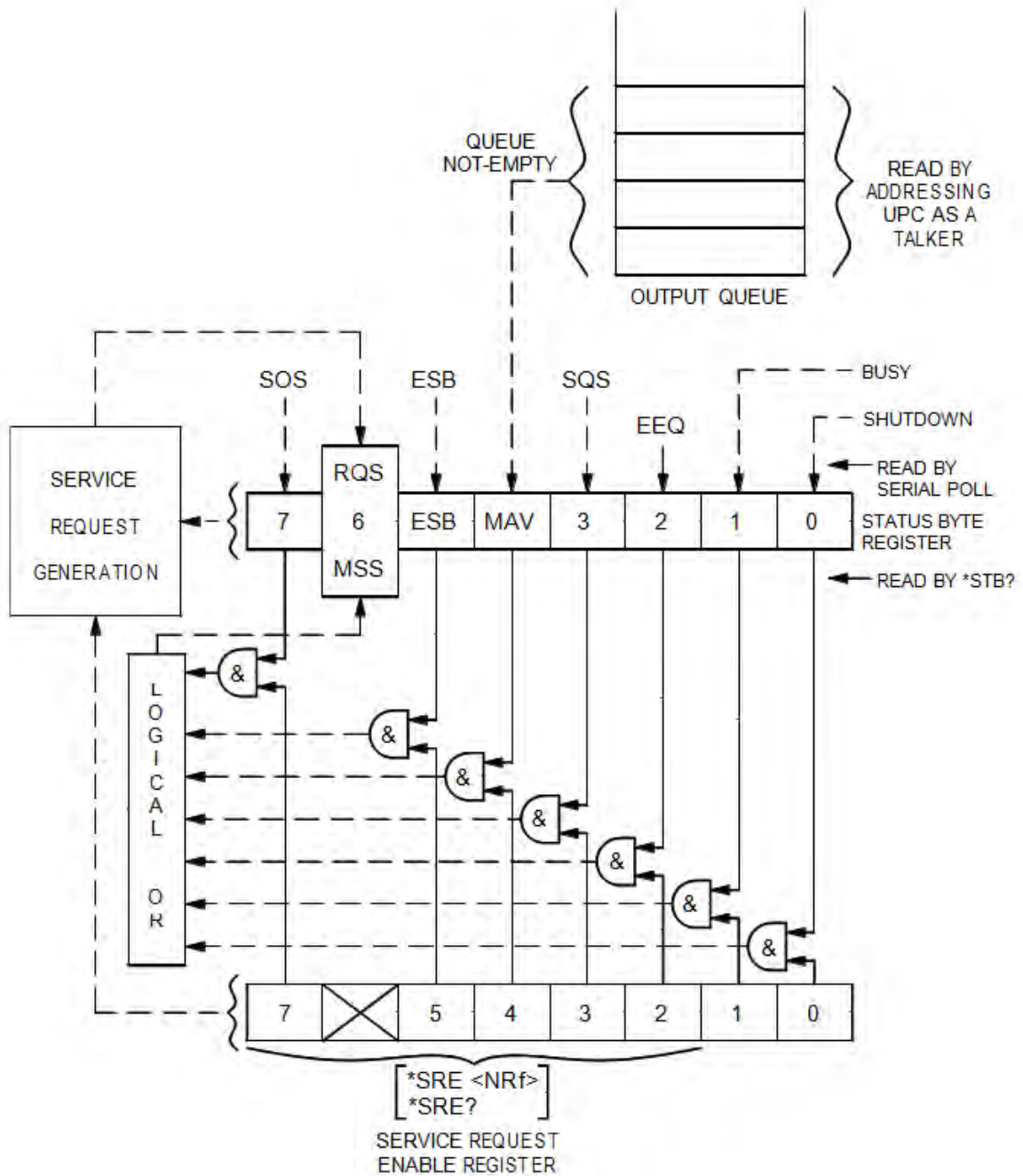


Figure 8-2: Status Byte Logical Model

### 8.13.2 Status Event Register (ESR)

Events reported by the STANDARD EVENT STATUS register may be queried via the \*ESR? command. Reading the ESR register clears it. The EVENT STATUS summary bit in the STATUS BYTE (STB) will be set when an unmasked EVENT STATUS bit goes true.

BIT	NAME	DEFINITION
7	PON	POWER ON indicates Input power was just applied
6	URQ	USER REQUEST indicates "LOCAL" key was just pressed
5	CME	COMMAND ERROR indicates invalid command or query received
4	EXE	EXECUTION ERROR indicates can't execute command with data received
3	DDE	DEVICE DEPENDANT ERROR indicates UPC not properly configured
2	QYE	QUERY ERROR indicates cannot respond with data
1	RQC	REQUEST CONTROL - not used
0	OPC	OPERATION COMPLETE indicates previous operation complete

Table 8-5: Status Event Register (ESR)

Setting an EVENT STATUS ENABLE (ESE) bit true unmask the EVENT bit in the ESR. Also see :SYStem:ERRor? query for relevant information.

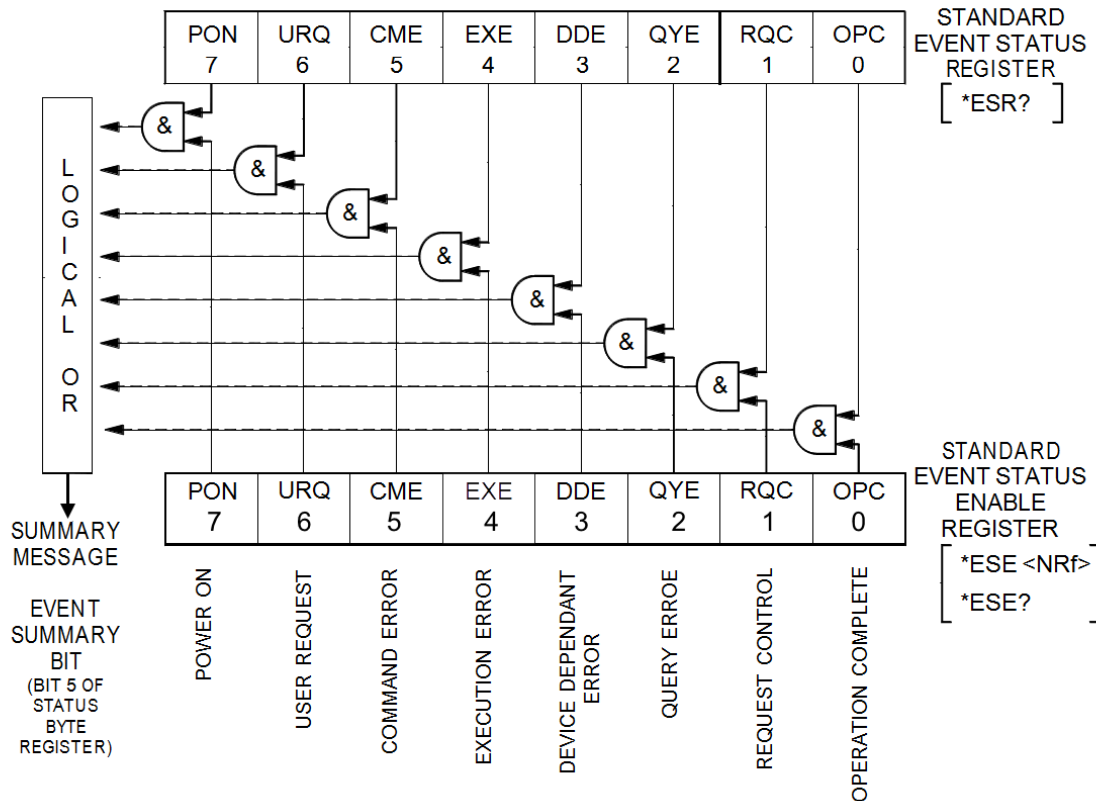


Figure 8-3: Standard Event Register (ESR) Model

### 8.13.3 SCPI Status Registers

The STATUS:OPERation and STATUS:QUESTIONable registers provide information about the present mode of operation.

- Transition of a CONDITION bit to the true state causes the EVENT bit to be set true.
- Unmasked ENABLE bits allow an EVENT bit to be reported in the summary bit for that EVENT register in the STATUS BYTE register.
- Setting an ENABLE bit true, unmask the corresponding EVENT bit.
- Reading an EVENT register clears it.
- All :STATUS registers are 16 bits (Figure 5.3).

The STATUS:OPERation register provides information about the present mode of operation.

Relevant commands for the STATUS:OPERation register are:

:STATUS:OPERation:CONDition?

:STATUS:OPERation:ENABle

:STATUS:OPERation:ENABle?

:STATUS:OPERation:EVENT?

The STATUS:QUESTIONABLE register provides information about errors and questionable measurements.

Relevant commands for the STATUS:QUESTIONABLE register are:

:STATUS:QUESTIONable:CONDition?

:STATUS:QUESTIONable:ENABle

:STATUS:QUESTIONable:ENABle?

:STATUS:QUESTIONable:EVENT?

Refer to Figure 8-4, “SCPI Status Registers Model” for details on registers.

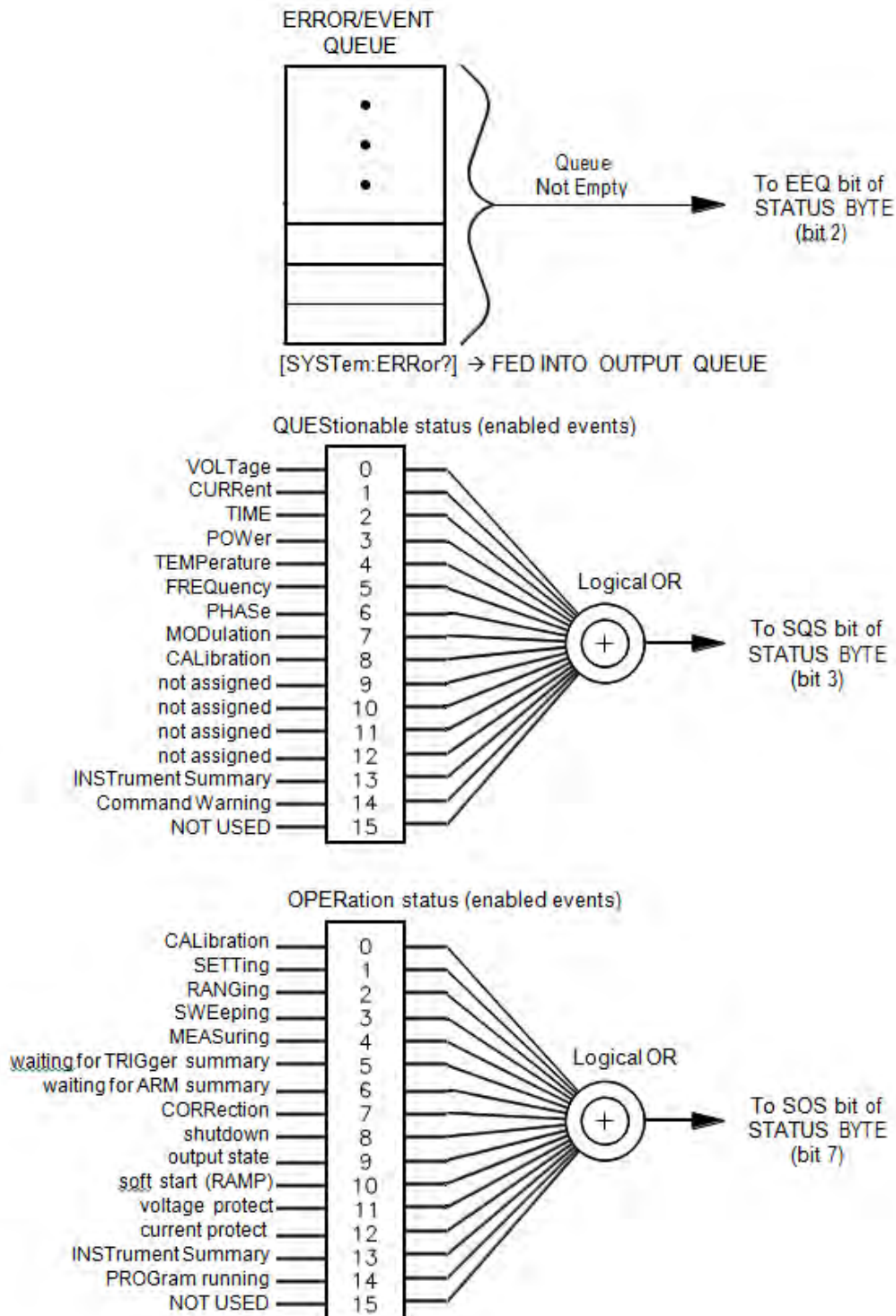


Figure 8-4: SCPI Status Registers Model

## 9 USB Driver Installation

### 9.1 Overview

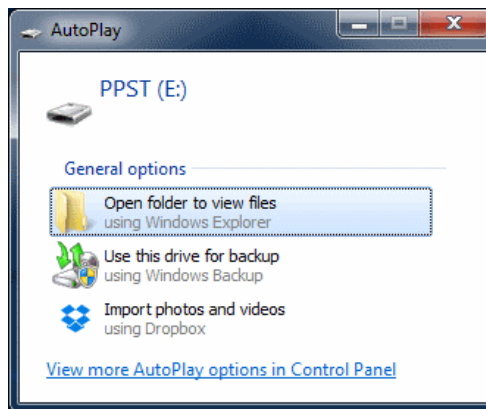
The USB interface provides a virtual COM port for the PC. Via this port, the unit can be controlled as a normal RS232 interface, e. g. with a terminal program or user application program. There are two drivers provided with the LSX units:

- Virtual COM driver** This allows communication with the power sources using a virtual serial port (COMx).
- Network Driver** This allows communication with the power source using a virtual IP address. Using this driver, all built-in web server functions are available via USB using a browser.

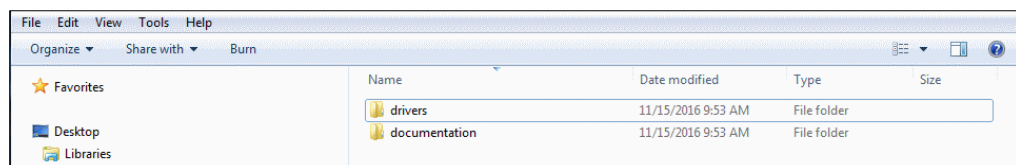
### 9.2 Installation

USB drivers are stored in the LSX controller and installed when the unit is first connected to a Windows PC. Proceed as follows:

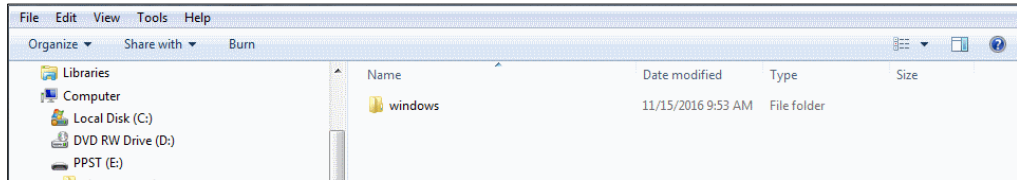
1. With the LSX unit powered up, connect a USB cable between the LSX USB Device port on the rear panel and an available USB port on a Windows PC.
2. Once plugged it, the PC should detect the present of the LSX. If this is the first time you connect to this PC, the drivers must be installed. This process should run automatically but if for some reason it does not, follow the subsequent steps.
3. On the drive popup shown below, select the “Open folder to view files” entry.



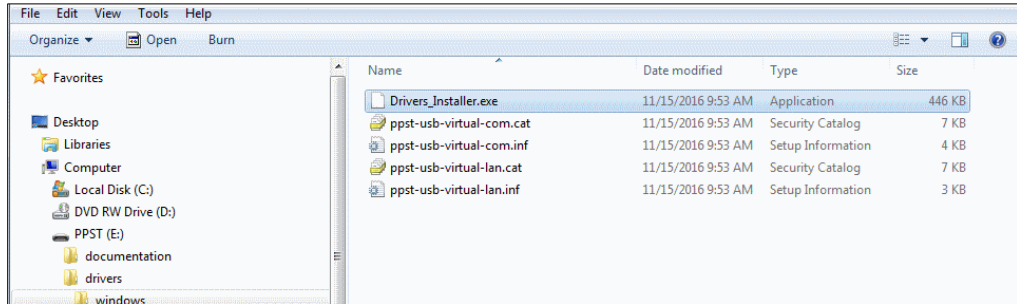
4. The directories shown below will be visible. Select the “drivers” directory



- Next, select the “Windows” directory



- Run the “Driver\_Installer.exe” located in this directory as shown below.,



- Allow the installation to complete.

At the end of this process, you should be able to see the two PPST USB drivers in the Windows Device Manager window under “Network Adaptors” and “Ports (COM & LPT)” respectively. The USB interface is now ready for use.

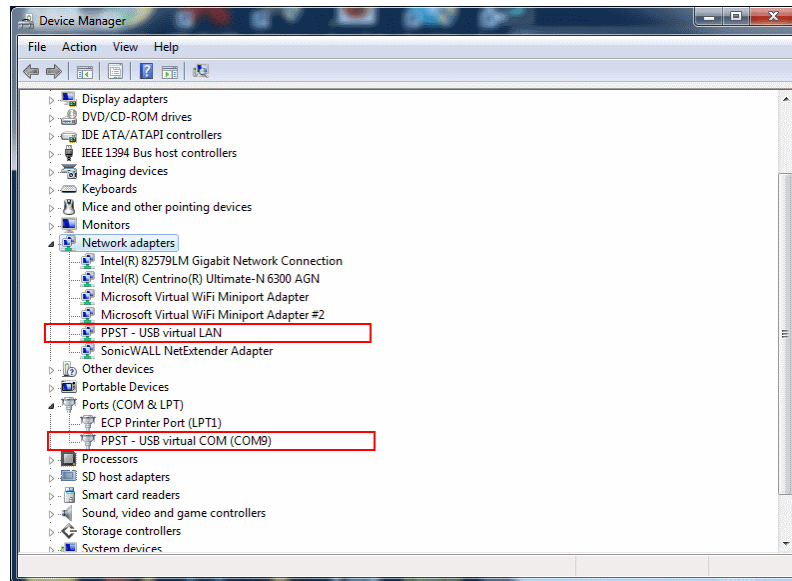


Figure 9-1: PPST USB Drivers visible in Windows Device Manager



## 10 LAN Interface Configuration

### 10.1 Overview

All LSX models are equipped with a LAN (Ethernet) interface. As shipped, the unit automatically obtains an IP address from the network using the DHCP protocol. If the instrument is turned off for long periods, the IP address lease may expire and a new IP address will be assigned. If this is the case, it is possible to assign a fixed IP address instead.

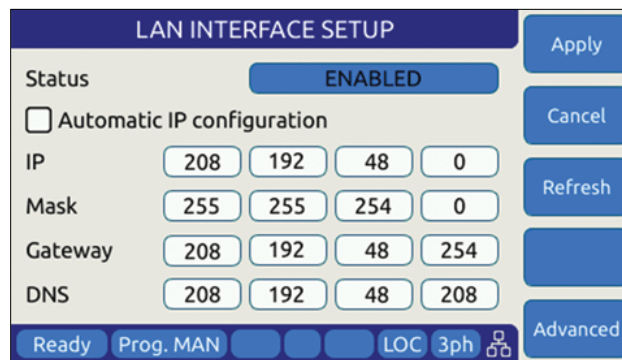
### 10.2 Web Browser Interface

The LSX Series® conforms to the LXI (Lan eXtensions for Instrumentation) standard and as such has a built in web server. This allows communication with the LSX from any web browser as long as the LSX is on the same network.

**Note:** The LSX web server has been tested with Google Chrome and Mozilla Firefox browsers only. Microsoft Internet Explorer is now obsolete and is not supported. Other browser like Edge or Safari may not fully operate or display information correctly.

**Note:** Web server use from a browser is **not** supported in *UPC Compatibility* mode. Disable this mode when operating the LSX from a web browser.

Use the IP address shown in the LAN INTERFACE SETUP screen under the SYSTEM key to determine the IP address to type into the web browser.




### CAUTION: BEFORE USING BROWSER CONTROL

Verify that the level of remote access control is appropriate for the situation at hand. The power source is capable of producing lethal output voltage and operating it without being physically in the same room or space present a safety risks to others. Refer to 10.3.2, “**Front Panel Access Control**”.

If the unit is on the same network or reachable through the internet, the home screen of the LSX web server will appear.

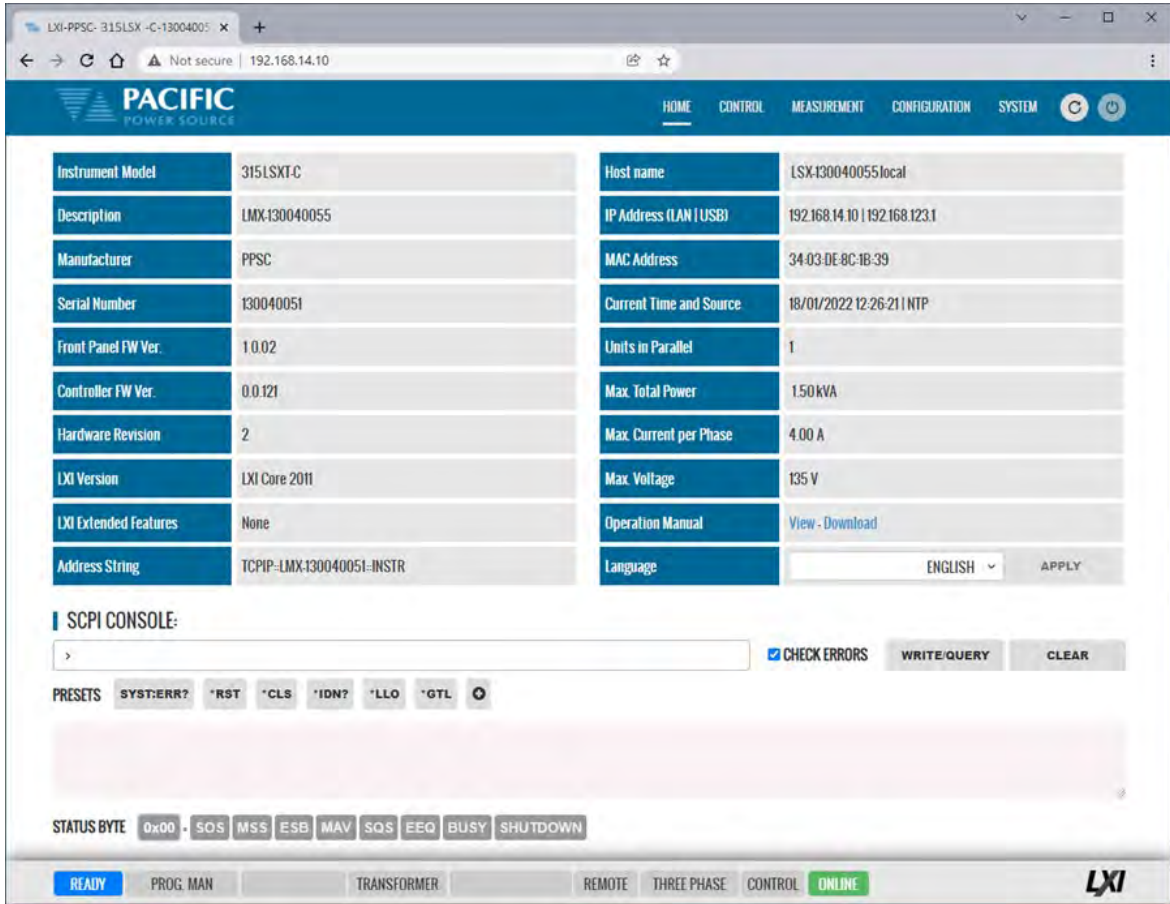


Figure 10-1: LXI Web Server Home Screen

When permitted, the browser interface allows monitoring of measurements and/or full control of the power source. If the operator is not near the actual instruments being controlled, care must be taken to the appropriate access control limits.

### 10.3 Access Control

Since the power source is capable of producing hazardous voltages at its output terminals, remote operation of the product over a LAN connection or any other available remote control interface can be restricted by the user to include only monitoring functions rather than full programming controls.

This feature is provided to ensure the safety of anyone near the unit in its actual physical location. This access control mechanism requires granting specific access to certain functions and features from the front panel by a person present at the location of the power source and requesting permission first trying to access a unit remotely.

These access control functions can be set from the SYSTEM Menu, INTERFACE screen or via the webserver using any browser.



## CAUTION

All LSX Units are shipped from the factory with ACCESS CONTROL **DISABLED**. It is the instrument's owner's responsibility to enable these features.

### 10.3.1 Browser Access Control

When connecting to the power source via a browser on which access has been restricted, the following message will appear:

The browser Access dialog is shown below.

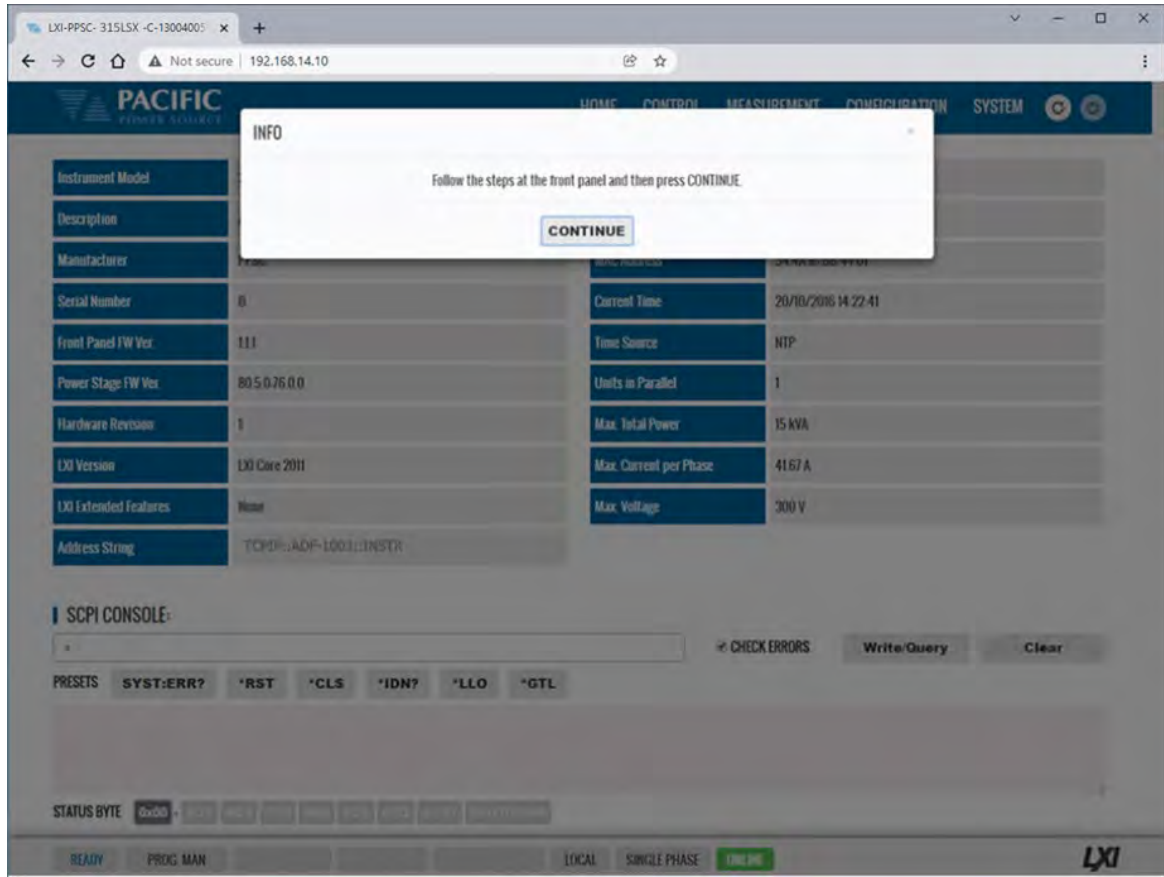


Figure 10-2: ACCESS CONTROL Dialog Screen

If the operator knows the four-digit access password that was set on the actual unit, he can enter the password code and gain full control of the source or Monitor<sup>16</sup> only access depending on which mode was selected.

If the operator does not know the password, he can request access. Such a request can only be granted by a person who is in front of the actual unit however. This prevents unauthorized access from a remote location and protects the local user from possible harm. An Access Request will result in a Pop-Up message on the power source LCD screen.

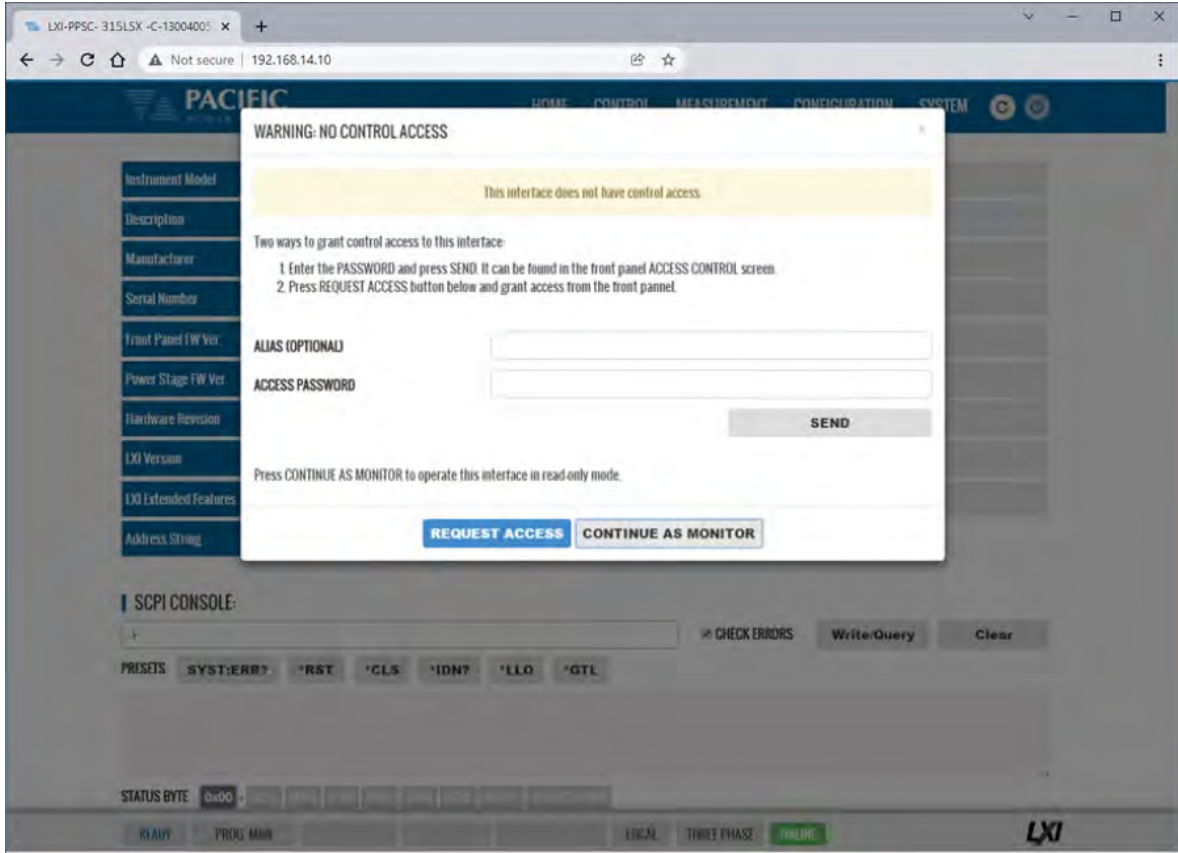
The access control password can be set/changed only by the person(s) present at the physical location of the unit. Factory default password is “1234” but it is strongly **advised** the end user changes this to his own code after receipt of the unit.

If access is denied, the browser interface will enter MONITOR only mode in which measurements and settings can be viewed remotely but control is possible. When in this mode, a user with knowledge of the access password can enter FULL CONTROL mode by supplying the

<sup>16</sup> Note: Monitor Only access mode requires firmware revision 3.6.44 or higher.

correct password or request full access from a local operator that is present at the unit’s location.

This dialog will appear when opening the browser interface while a unit is under ACCESS CONTROL.



Clicking on “REQUEST ACCESS” will result in a dialog box appearing on the unit’s LCD screen displaying the requestors IP address. A message on the browser will indicate action is needed by the local operator. Now, the local operator can either DENY or GRANT access.

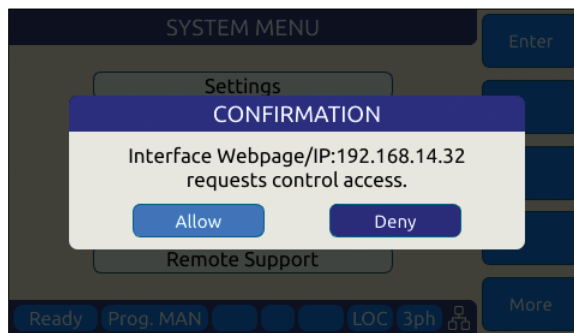
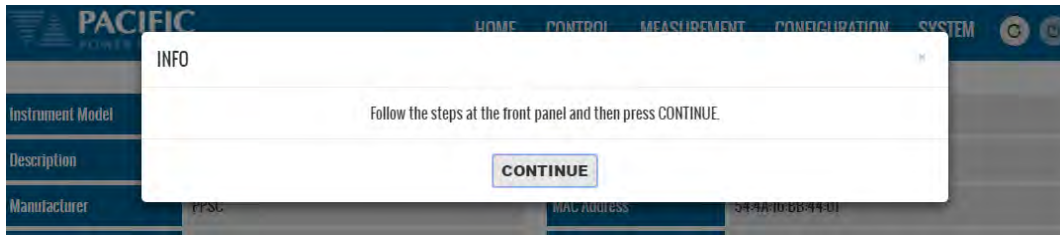


Figure 10-3: Remote Access Control Request Dialog

If remote access is granted, full control is provided. If denied, only monitoring is available.

**Note:** If the remote operator was given the ACCESS passcode, he can use it to gain access without a local operator’s intervention.



When granted, the requestor’s IP address will be added to the whitelist IP. The operator can remove any of the white listed IP address at any time if needed. This will lock out remote access for that PC until access is re-granted anew.

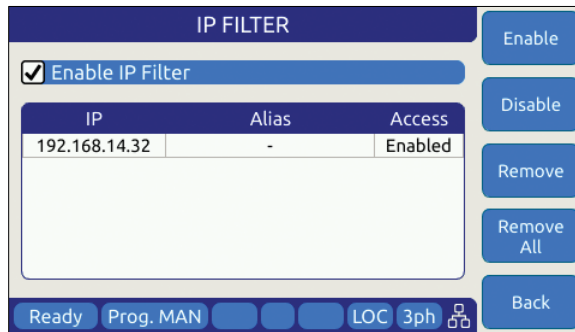
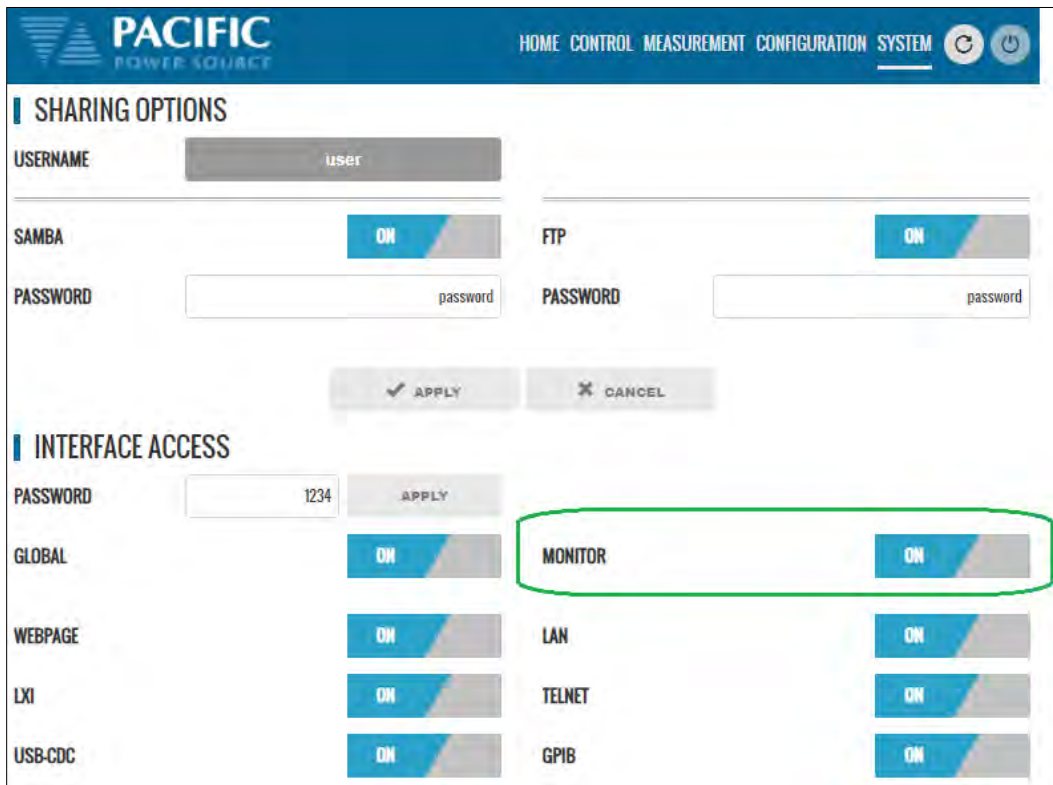
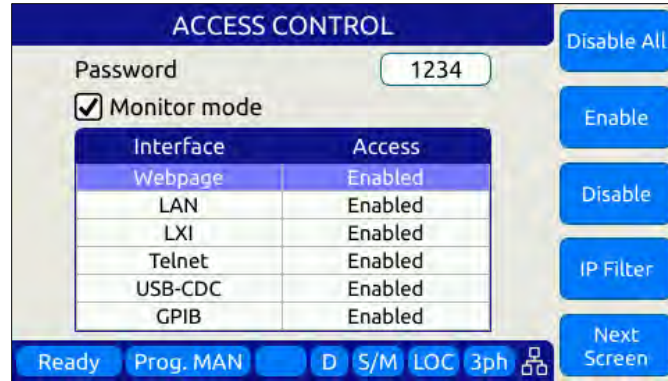


Figure 10-4: Remote Access Control IP Filter screen

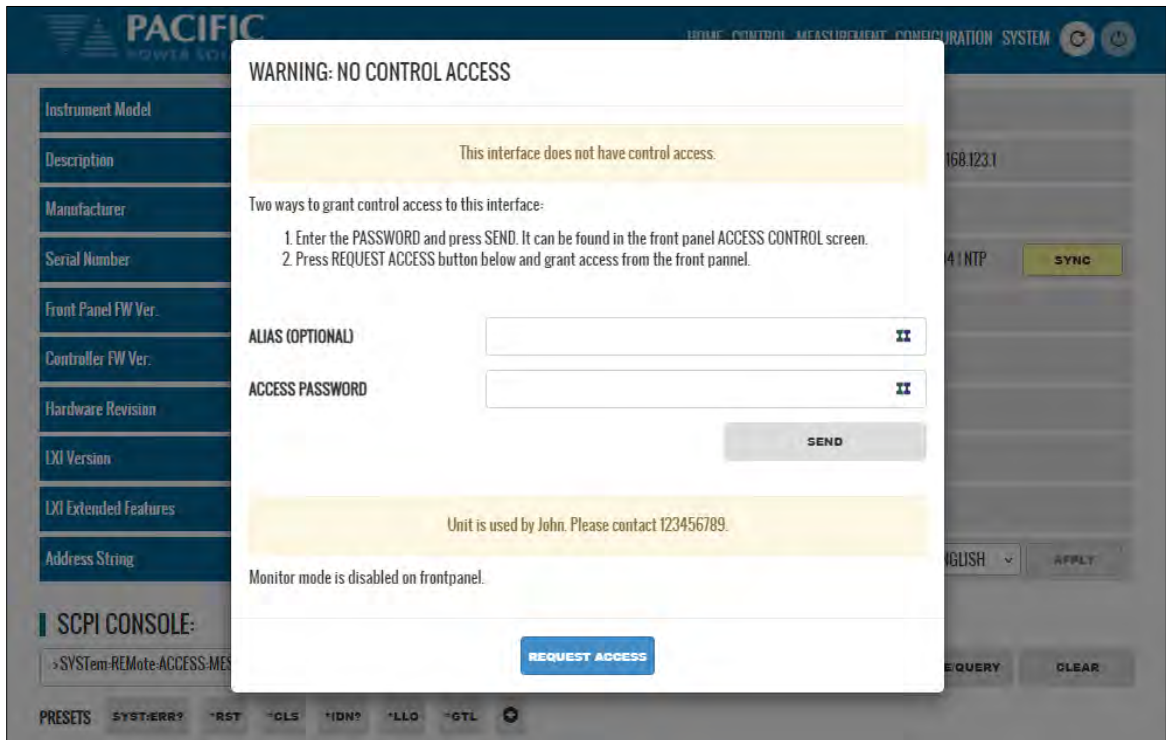
changes can be mode remotely.



Monitor mode can also be selected from the front panel using the System, Access Control screen as shown below.



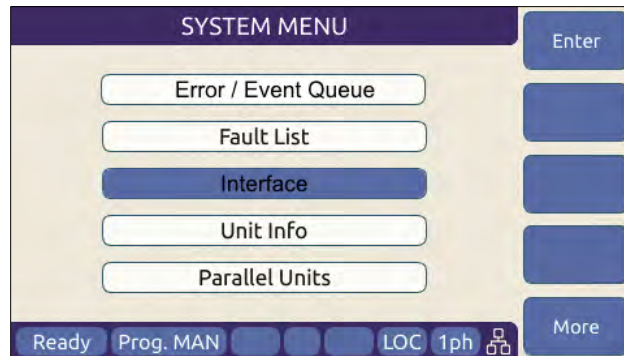
If Monitor mode is disabled, the browser access control screen will look like this.



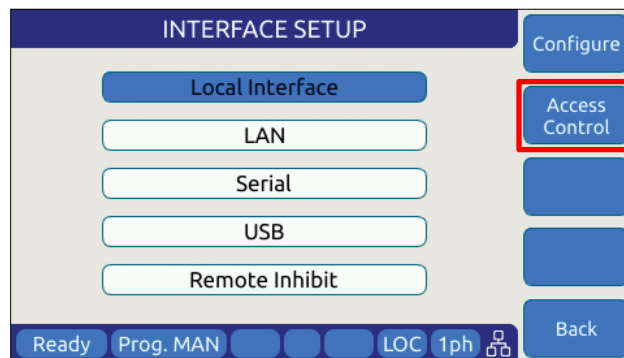
The message at the bottom of the screen can be set by the main user with the `SYSTEM:REMOte:ACCESS:MESSAge` SCPI command. In this example, the following command was used:  
`SYSTEM:REMOte:ACCESS:MESSAge "Unit is used by John. Please contact 123456789."`

### 10.3.2 Front Panel Access Control

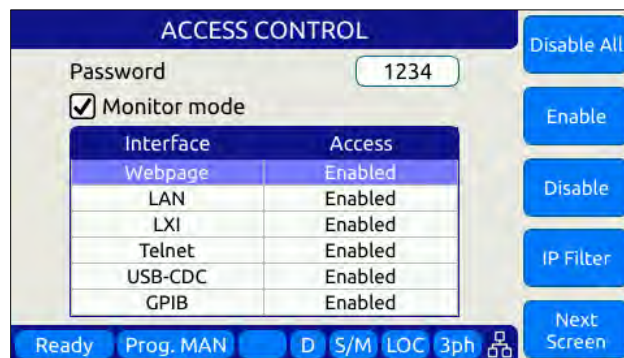
Setting remote control access levels and interface types is accomplished from the SYSTEM menu under Interfaces.



Scroll down to the INTERFACE entry and press Enter to access the available INTERFACE SETUP screen.



The second soft key is labelled “Access Control” and brings up the access control screen shown below.



The IP Filter list will provide access to the list of IP addresses that have been granted access by the local operator. This list can be erased if it is necessary to deny future access to the power source.



## 10.4 Web Browser Interface

The LSX Series® conforms to the LXI (Lan eXtensions for Instrumentation) standard and features a built-in web server with a greatly expanded feature set. This allows communication with the LSX from any web browser as long as the LSX is reachable through the network or internet. The expanded feature set of the web server often eliminates the need to use additional Windows or other platform based software.

## 10.5 Available Web Interface Menu Tree

The following areas of control, monitoring and configuration of the LSX power source are available through a web browser.

- Home Screen – Required for LXI compliance
- Home Screen SCPI Console Command Line Interface
- SOURCE CONTROL
  - PROGRAM
  - PROTECTIONS
  - TRANSIENTS
  - PROGRAM MEMORY
  - WAVEFORM
  - WAVEFORM EDITOR
  - SCPI SCRIPT
- MEASUREMENTS
  - MONITOR
  - REAL-TIME PLOT
  - V/I PLOT
  - DATALOGGER
  - SCOPE
  - HARMONICS
- CONFIGURATION
  - UNIT SETTINGS
  - USER LIMITS & PRESETS
  - RAMP & SLEW
- SYSTEM
  - ERROR/EVENT QUEUE
  - FAULT LIST
  - INTERFACE SETUP
  - ACCESS CONTROL
  - DIGITAL & ANALOG IOS
  - UNIT INFORMATION
  - PARALLEL UNITS
  - MEMORY MANAGER
  - CALIBRATION
  - REMOTE SUPPORT
  - IMPORT/EXPORT
  - FIRMWARE UPDATE
  - SANITIZE & REBOOT

Following sections provide an overview of each page of the web browser interface.

## 10.6 Home Screen

The Home screen contains all required information relating to the instrument and its LAN connection as required by the LXI standard. This includes hardware and firmware revision information. The NTP clock **SYNC** button in the Current Time field is yellow if it detects that the date, time or zone is different than the computer, otherwise is in gray. Press the button to sync to the NTP time server.

The screenshot shows the LXI Home Screen in a web browser. The browser address bar shows '192.168.14.10'. The page has a blue header with the Pacific Power Source logo and navigation tabs: HOME, CONTROL, MEASUREMENT, CONFIGURATION, SYSTEM. The main content area is divided into two columns of key-value pairs:

Instrument Model	315LSXT-C	Host name	LSX:130040055local
Description	LMX:130040055	IP Address (LAN   USB)	192.168.14.10   192.168.123.1
Manufacturer	PPSC	MAC Address	34-03-DE-8C-1B-39
Serial Number	130040051	Current Time and Source	24/05/2022 12:50:54   NTP <b>SYNC</b>
Front Panel FW Ver.	1.0.02	Units in Parallel	1
Controller FW Ver.	0.0.121	Max. Total Power	150 kVA
Hardware Revision	2	Max. Current per Phase	4.00 A
LXI Version	LXI Core 2011	Max. Voltage	135 V
LXI Extended Features	None	Operation Manual	<a href="#">View - Download</a>
Address String	TCPIP-LMX:130040051-INSTR	Language	ENGLISH <input type="button" value="APPLY"/>

Below the key-value pairs is the SCPI Console section. It includes a text input field with a dropdown arrow, a 'CHECK ERRORS' checkbox, and buttons for 'WRITE/QUERY' and 'CLEAR'. Below the input field are 'PRESETS' buttons: \*SYSTEMERR?, \*RST, \*CLS, \*IDN?, \*LLO, \*GTL, and a refresh icon. At the bottom of the console is a 'STATUS BYTE' row with buttons: 0x00, SOS, MSS, ESB, MAV, SQS, EEQ, BUSY, SHUTDOWN. At the very bottom of the screen are status indicators: READY, PROG. MAN, TRANSFORMER, REMOTE, THREE PHASE, CONTROL, and ONLINE (highlighted in green). The LXI logo is in the bottom right corner.

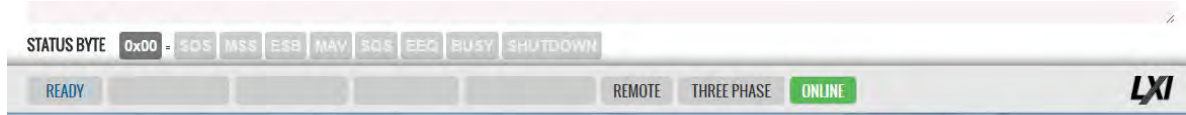
### 10.6.1 SCPI Console Command Line Interface

Near the bottom of the screen is an interactive command line interface that allows individual SCPI commands to be sent to the instrument. Any query results are shown in the text box below the command line. A drop-down list of all available commands is integrated in the command line and as you type a command, a match will be tracking in the drop down list allowing you to select the complete command without typing it out. See sample below after typing "SY".

This screenshot shows the SCPI Console with the command 'SY' entered in the input field. A dropdown menu is open, listing the following commands: SYSTEM-ERROR-NEXT?, SYSTEM-ERROR-ALL?, SYSTEM-ERROR-ALL-NOCLEAR?, SYSTEM-ERROR-ALL-CLEAR?, SYSTEM-ERROR-POE?, SYSTEM-ERROR-POE?, SYSTEM-VERSION?, SYSTEM-LXI-VERSION?, SYSTEM-LXI-FEATURES?, SYSTEM-MANUFACTURER?, and SYSTEM-SCPI-IMPLEMENTATION?. The 'CHECK ERRORS' checkbox is checked, and the 'Write/Query' and 'Clear' buttons are visible. The status bar at the bottom shows 'ONLINE' in green.

### 10.6.2 Status Byte Display

At the very bottom of the Home Screen, the status byte register value and decoded fields are displayed for reference. Status byte fields are described in section 8.12.1, “Status Byte Register (STB)” on page 394.



### 10.6.3 Browser Status Bar

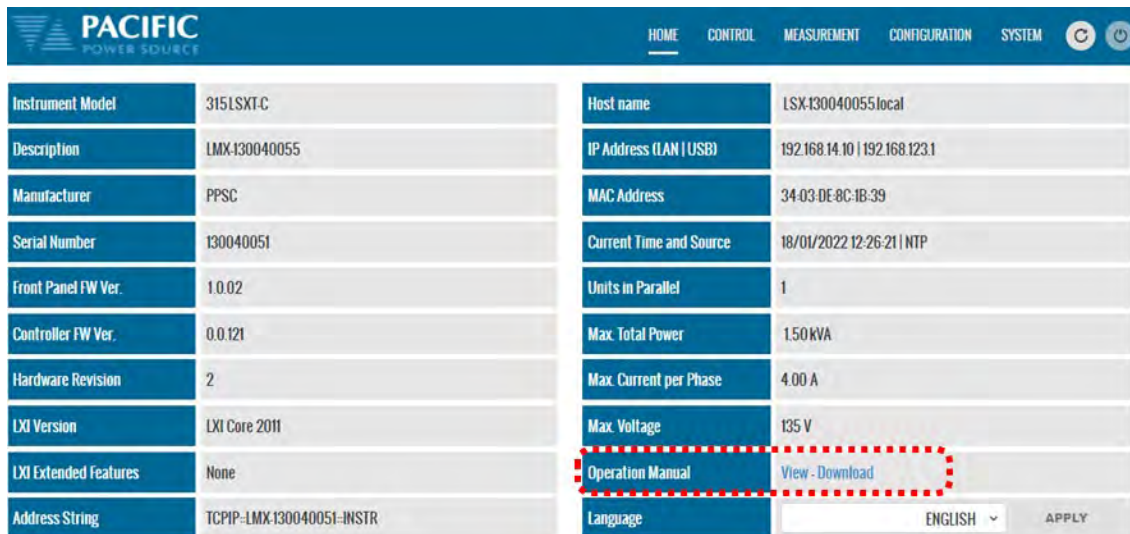
The browser status bar shows configuration information about the instrument. This includes any error or event flags, remote or local status, phase mode selection and on or off line status.



The first field will display **READY** while the power source output is OFF and **ENABLED** when it is ON (enabled).

### 10.6.4 Operation Manual PDF

The LSX Operation Manual is stored on the LSX’s internal memory and available for download to the user’s PC (“Download”) or for viewing using a suitable browser of PDF viewer (“View”).



### 10.6.5 Language Selection

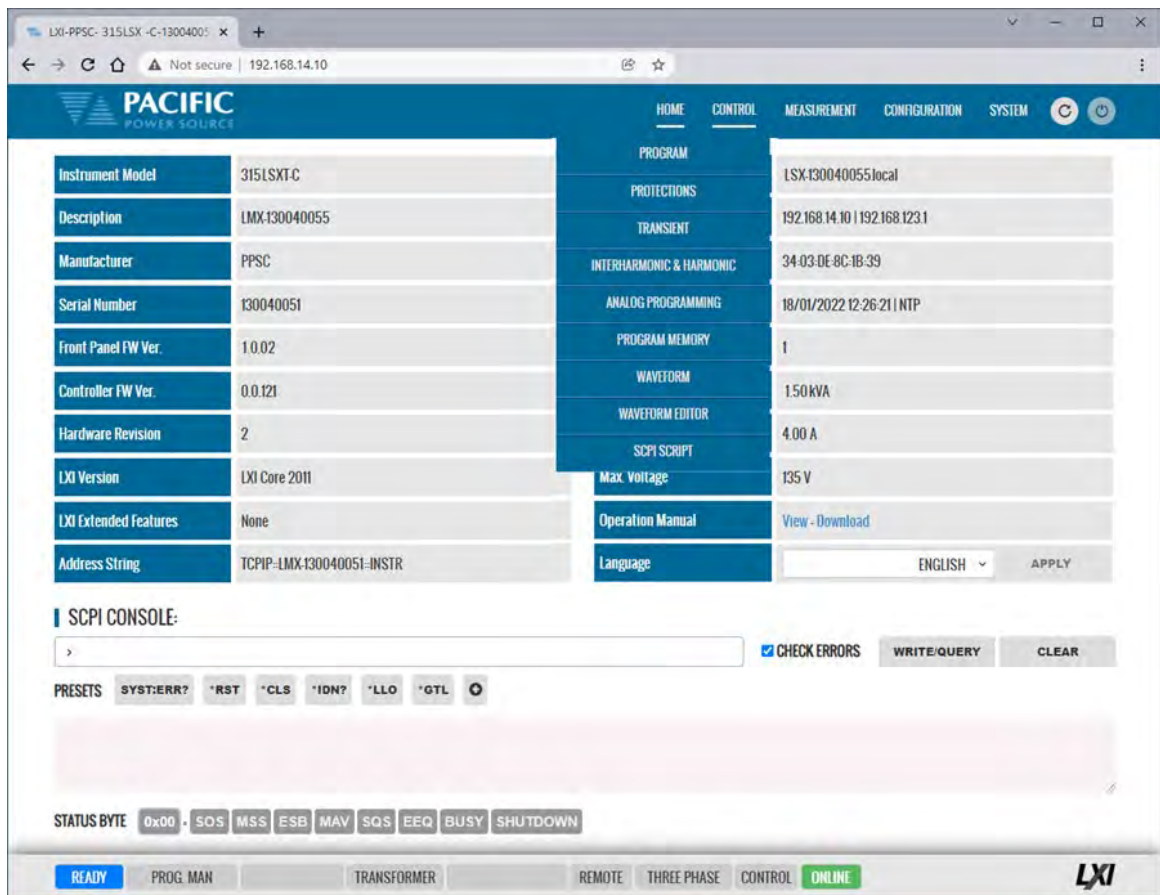
Available language selections in the lower right corner of the home screen are ENGLISH or CHINESE (中文).

## 10.7 Source Control Screens

The CONTROL menu provides access to several screens that allow programming of the power source. Control Menu entries are as follows:

- PROGRAM
- PROTECTIONS
- TRANSIENT
- INTERHARMONIC & HARMONIC
- ANALOG PROGRAMMING
- PROGRAM MEMORY
- WAVEFORM
- WAVEFORM EDITOR
- SCPI SCRIPT
- TEST SEQUENCE

Each is described in subsequent sections.



The screenshot shows the LXI web interface for a Pacific Power Source. The browser address bar shows '192.168.14.10'. The interface has a blue header with the Pacific Power Source logo and navigation tabs: HOME, CONTROL, MEASUREMENT, CONFIGURATION, and SYSTEM. The CONTROL menu is expanded, showing options: PROGRAM, PROTECTIONS, TRANSIENT, INTERHARMONIC & HARMONIC, ANALOG PROGRAMMING, PROGRAM MEMORY, WAVEFORM, WAVEFORM EDITOR, SCPI SCRIPT, Max. Voltage, Operation Manual, and Language.

On the left, a table displays system information:

Instrument Model	315LSXT-C
Description	LMX-130040055
Manufacturer	PPSC
Serial Number	130040051
Front Panel FW Ver.	1.0.02
Controller FW Ver.	0.0.121
Hardware Revision	2
LXI Version	LXI Core 2011
LXI Extended Features	None
Address String	TCPIP=LMX-130040051-INSTR

On the right, a table displays control parameters:

PROGRAM	LSX130040055local
PROTECTIONS	192.168.14.10   192.168.123.1
TRANSIENT	34-03-DE-8C-1B-39
INTERHARMONIC & HARMONIC	18/01/2022 12:26:21   NTP
ANALOG PROGRAMMING	1
PROGRAM MEMORY	1.50 kVA
WAVEFORM	4.00 A
WAVEFORM EDITOR	135 V
SCPI SCRIPT	<a href="#">View - Download</a>
Max. Voltage	ENGLISH
Operation Manual	APPLY
Language	

Below the tables is the SCPI CONSOLE with a text input field, a 'CHECK ERRORS' checkbox, and buttons for 'WRITE QUERY' and 'CLEAR'. There are also 'PRESETS' buttons: SYST:ERR?, \*RST, \*CLS, \*IDN?, \*LLO, \*GTL, and a refresh icon.

At the bottom, a 'STATUS BYTE' section shows: 0x00, SOS, MSS, ESB, MAV, SQS, EEQ, BUSY, SHUTDOWN. The bottom status bar includes: READY, PROG. MAN, TRANSFORMER, REMOTE, THREE PHASE, CONTROL, and ONLINE (highlighted in green). The LXI logo is in the bottom right corner.

### 10.7.1 Program

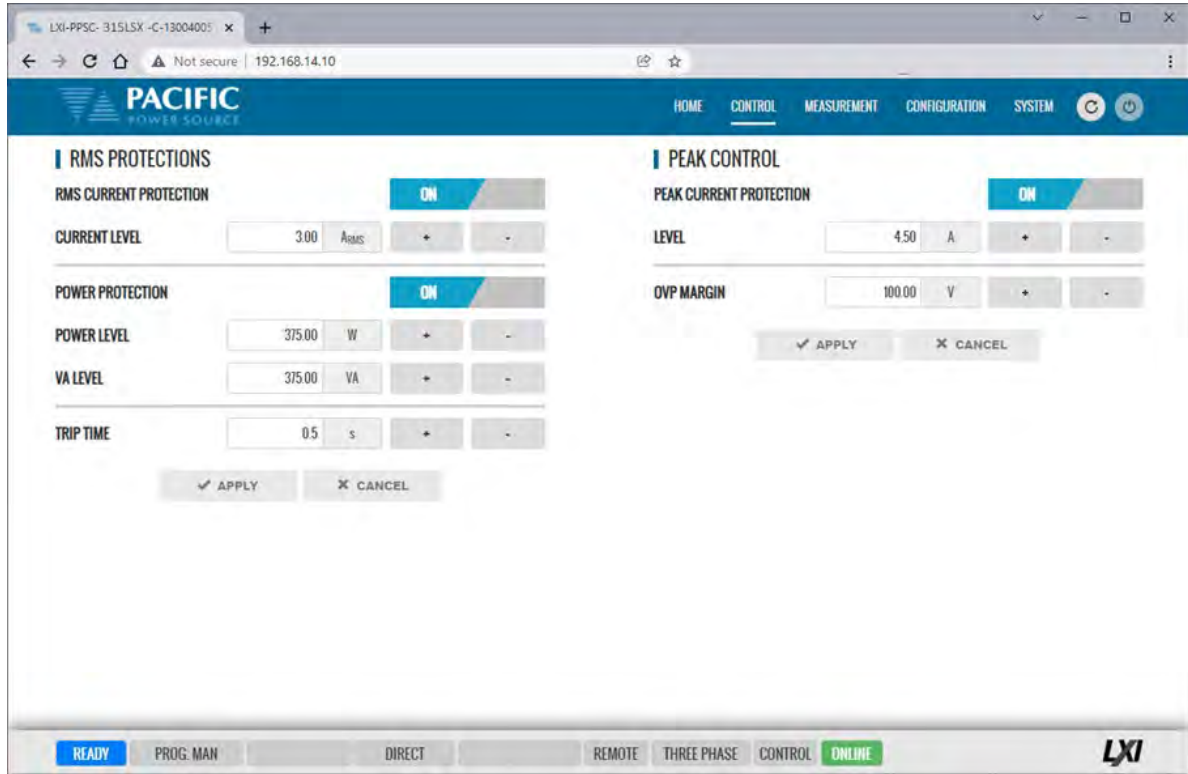
The program control screen allows programming of all output parameters, operating modes etc. It also displays measurement data for all available phases in the lower part of the screen. In three or two phase mode, Line-to-Line voltage measurements are displayed at the bottom of the screen. The Output can be enabled using the “OUTPUT ENABLE” controls in the upper PROGRAM screen. The Output can also be turned **OFF** from any screen using the RED On/Off symbol in the menu bar, which is accessible from all screens. This allows quick opening of the output relay if needed from any screen without have to first select the PROGRAM screen. Note that the output can only be turned **ON** (or OFF) from the PROGRAM screen however.

The screenshot displays the 'PROGRAM' screen of the Pacific Power Source web interface. At the top, there is a navigation bar with 'HOME', 'CONTROL', 'MEASUREMENT', 'CONFIGURATION', and 'SYSTEM' tabs. A red box highlights the 'OUTPUT ENABLE' section, which includes 'ON' and 'OFF' buttons. Below this, there are input fields for 'FREQUENCY' (50.00 Hz) and 'VOLTAGE AC' (120.00 V<sub>RMS</sub>). To the right, there are 'SELECTED PHASE' (ABC), 'CURRENT LIMIT' (120 A), 'POWER LIMIT' (375.00 W), and 'VA LIMIT' (375.00 VA) settings. A red arrow points to a power button in the top right corner of the interface. Below the settings, there are 'APPLY' and 'CANCEL' buttons. The 'MEASUREMENTS' table is shown below, with columns for Phase A, Phase B, and Phase C. The table includes various parameters such as Frequency, Voltage L-N RMS (AC-DC), Voltage L-N THD, Voltage L-N DC, Current RMS (AC-DC), Current THD, Power, Watt-Hour, App Power, Power Factor, Current CF, Peak Current, and Recorded Peak Current. At the bottom, there is a status bar with 'READY', 'PROG. MAN', 'TRANSFORMER', 'REMOTE', 'THREE PHASE', 'CONTROL', and 'ONLINE' indicators, along with the LXI logo.

	Phase A	Phase B	Phase C
FREQUENCY	50.00 Hz	50.00 Hz	50.00 Hz
VOLTAGE L-N RMS (AC-DC)	0.10 V <sub>RMS</sub>	0.11 V <sub>RMS</sub>	0.11 V <sub>RMS</sub>
VOLTAGE L-N RMS (AC)	0.10 V <sub>RMS</sub>	0.11 V <sub>RMS</sub>	0.11 V <sub>RMS</sub>
VOLTAGE L-N THD	0.00 %	0.00 %	0.00 %
VOLTAGE L-N DC	0.01 V <sub>DC</sub>	0.00 V <sub>DC</sub>	-0.01 V <sub>DC</sub>
CURRENT RMS (AC-DC)	0.00 A <sub>RMS</sub>	0.00 A <sub>RMS</sub>	0.00 A <sub>RMS</sub>
CURRENT THD	0.00 %	0.00 %	0.00 %
POWER	0 W	0 W	0 W
WATT-HOUR	0.000 kWh	0.000 kWh	0.000 kWh
APP POWER	0 VA	0 VA	0 VA
POWER FACTOR	0.00	0.00	0.00
CURRENT CF	-	-	-
PEAK CURRENT	-0.01 A	0.00 A	-0.01 A
RECORDED PEAK CURRENT	-0.07 A	-	-

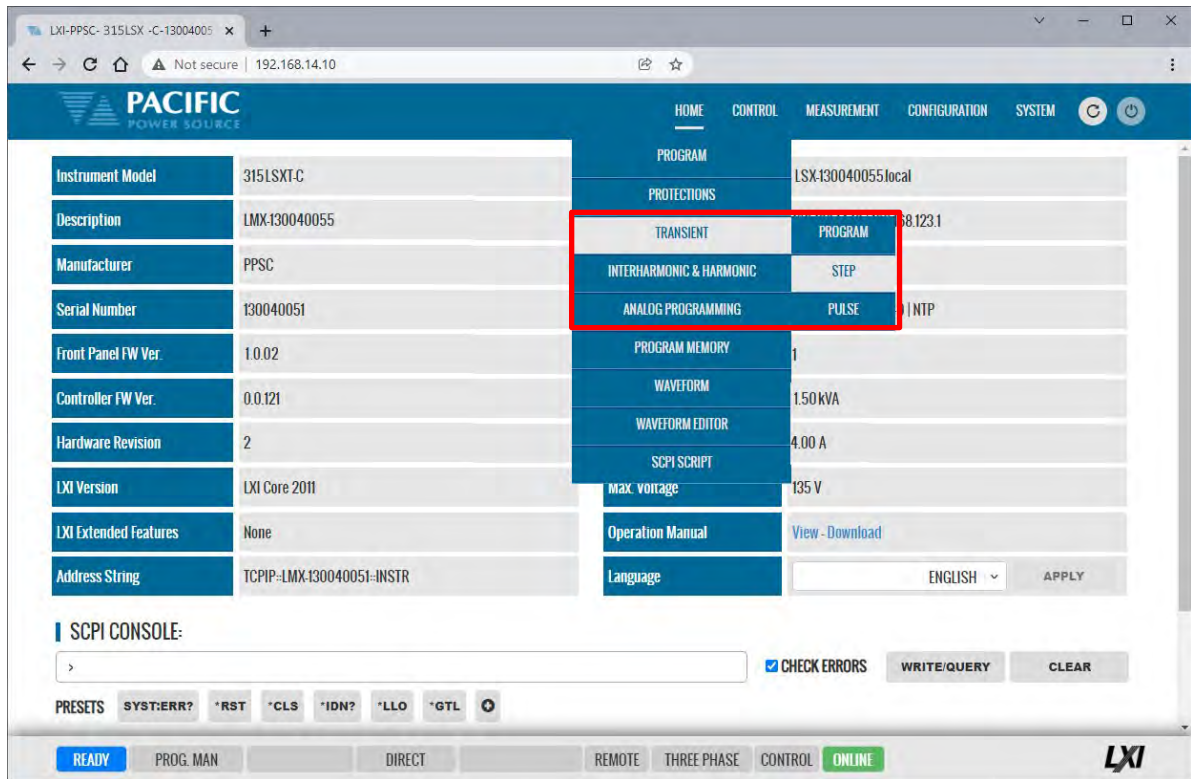
### 10.7.2 Protections

The Protections screen may be used to change protection modes and threshold values. This includes RMS current, Peak Current, True Power and Apparent Power protection modes. Modes can be toggled on or off individually.



### 10.7.3 Transients

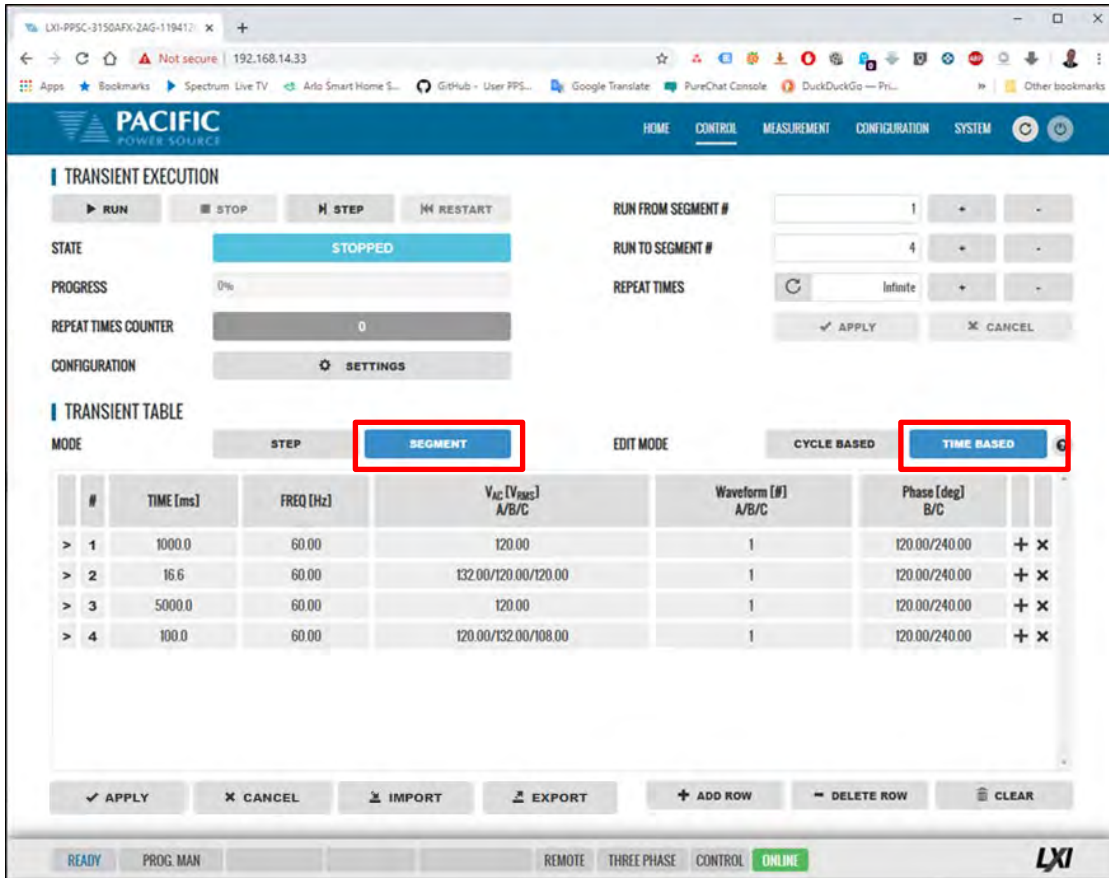
The transient control screen allows programming of new transients or execution control of new or stored transient programs. The power source supports LIST, STEP and PULSE transient modes.



### 10.7.3.1 LIST Transients

For LIST transients, both STEP mode and SEGMENT mode is supported. The bottom part of the screen shows the editable transient table. Execution controls are located in the top part of the screen.

Data entry mode can be selected as either STEP or SEGMENT. Dwell times can be entered using msec (TIME BASED) or cycles (CYCLE BASED). A sample TIME BASED Segment mode list is shown below.



During transient execution, a progress indicator is visible showing percent completion.

#### Import / Export Function

List Transients can be saved to excel compatible CSV files using the EXPORT button at the bottom of the List transient screen. A sample is shown to the right.

```

transient.csv - Notepad
File Edit Format View Help
SEP=,
Mode=Segment
Edit Mode=Time based
Time[ms],Frequency [Hz],AC [RMS],DC,Phase [Deg], Waveform
10.0,60,5/6/7,30/20/10,0/120/240,1/1/1
200.0,65,5/6/7,30/20/10,0/120/240,1/1/1
200.0,75,0/0/0,0/0/0,0/120/240,2/2/2
    
```

These same files can be Imported later eliminate the need to re-enter the transient list. The IMPORT button opens a file browser so select and load previously save CSV transient files. This function automatically changes between step or segment mode and edit mode according to the CSV file content.

A sample CYCLE BASED Segment mode list is shown below.



The screenshot displays the Pacific Power Source web interface. The top navigation bar includes 'HOME', 'CONTROL', 'MEASUREMENT', 'CONFIGURATION', and 'SYSTEM'. The main content area is divided into two sections:

- TRANSIENT EXECUTION:** This section contains controls for running and stopping a transient. The state is currently 'STOPPED'. It includes fields for 'RUN FROM SEGMENT #' (0), 'RUN TO SEGMENT #' (0), and 'REPEAT TIMES' (infinite). Buttons for 'RUN', 'STOP', 'STEP', 'RESTART', 'APPLY', and 'CANCEL' are present.
- TRANSIENT TABLE:** This section shows a table of transient configurations. The 'MODE' is set to 'STEP' and the 'EDIT MODE' is 'CYCLE BASED'. The table has columns for '#', 'CYCLES', 'FREQ [Hz]', 'V<sub>AC</sub> [V<sub>RMS</sub>] A/B/C', 'Waveform [#] A/B/C', and 'Phase [deg] B/C'. The table contains four rows of data.

At the bottom of the interface, there are status indicators: 'READY', 'PROG. MAN', 'REMOTE', 'THREE PHASE', 'CONTROL', and 'ONLINE'. The LXi logo is in the bottom right corner.

#	CYCLES	FREQ [Hz]	V <sub>AC</sub> [V <sub>RMS</sub> ] A/B/C	Waveform [#] A/B/C	Phase [deg] B/C
> 1	60	60.00	120.00	1/1/1	120.00/240.00
> 2	1	60.00	132.00/120.00/120.00	1/1/1	120.00/240.00
> 3	300	60.00	120.00	1/1/1	120.00/240.00
> 4	6	60.00	120.00/132.00/108.00	1/1/1	120.00/240.00

Continued on next page...

A sample TIME BASED STEP mode list is shown below. (Not to be confused with STEP Transient mode, see next section.)

The screenshot shows the Pacific Power Source web interface. The 'TRANSIENT EXECUTION' section includes controls for running, stopping, and restarting a transient, along with a progress indicator (0%) and a repeat times counter (0). The 'TRANSIENT TABLE' section shows a table of transient steps with columns for step number, ramp time, dwell time, frequency, voltage, waveform, and phase. The 'STEP' and 'TIME BASED' buttons are highlighted with red boxes.

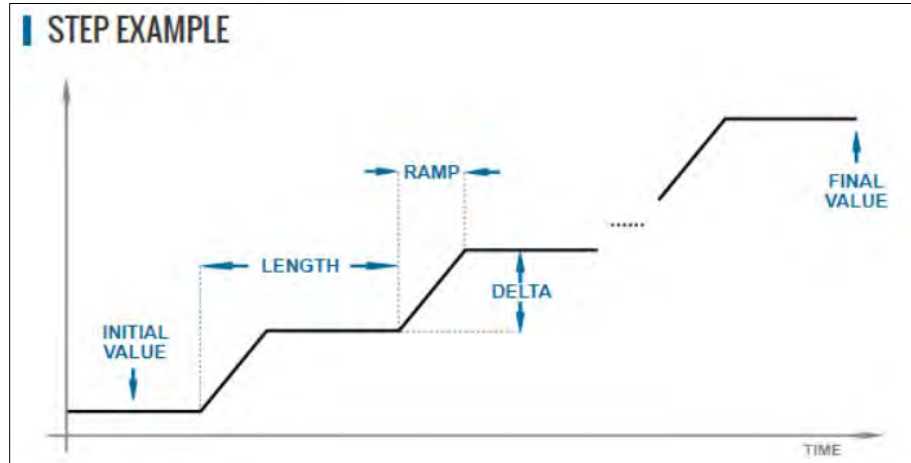
#	RAMP [ms]	DWELL [ms]	FREQ [Hz]	V <sub>AC</sub> [V <sub>RMS</sub> ] A/B/C	Waveform [#] A/B/C	Phase [deg] B/C
> 1	0.2	1000.0	60.00	120.00	1	120.00/240.00
> 2	0.2	16.8	60.00	132.00/120.00/120.00	1	120.00/240.00
> 3	100.0	5000.0	60.00	120.00	1	120.00/240.00
> 4	100.0	0.0	60.00	120.00/132.00/108.00	1	120.00/240.00

During transient execution, a progress indicator is visible showing percent completion.

### 10.7.3.2 STEP Transients

STEP transients allow a ramp or stairstep output profile to be programmed without creating LIST transients with multiple entries. In STEP transient mode, the user enters initial value, end value, delta step size, step duration, step count and no of repeats.

The STEP EXAMPLE shows the relationship between the various parameters.



This information is transformed to a standard Segment based transient list by the power source when the LOAD button is pressed.

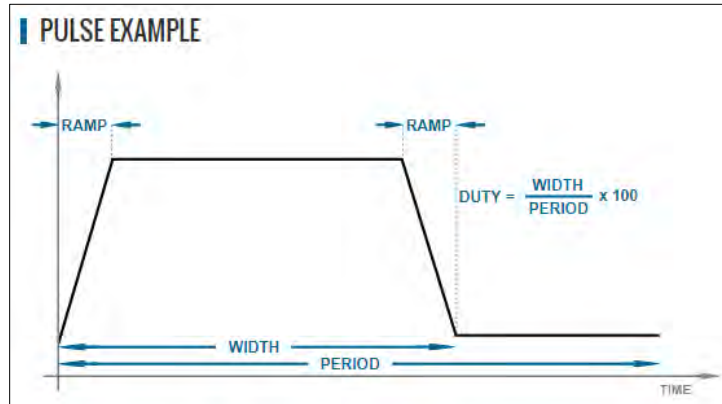
The screenshot shows the control interface for the Pacific Power Source. The 'STEP EXECUTION' section includes buttons for RUN, STOP, STEP, and RESTART. The state is currently 'STOPPED'. A 'LOAD' button is highlighted with a red box. The 'STEP SETTINGS' section includes fields for STEP LENGTH (100.0 ms), STEP RAMP TIME (0.2 ms), STEP COUNT (10), REPEAT TIMES (1), PROGRAM MODE (INITIAL & DELTA VALUES), and options for INITIAL VALUE STEP and HOLD FINAL VALUES (both set to ON). The 'STEP VALUES' section shows a table for selected phases (ABC, A, B, C) with columns for SETPOINT, INITIAL, DELTA, and FINAL values for FREQUENCY and VOLTAGE AC. A 'STEP EXAMPLE' graph is also visible at the bottom right of the interface.

During transient execution, a progress indicator is visible showing percent completion.

### 10.7.3.3 PULSE Transients

PULSE transients allow series of pulsed output levels to be programmed without creating LIST transients with repetitive entries. In PULSE transient mode, the user enters Level, duty cycle, ramp time, period, initial value and pulse count. This mode is useful for high and low line testing for voltage and frequency operating limits of an EUT.

The PULSE EXAMPLE shows the relationship between the various parameters.



This information is transformed to a standard Segment based transient list by the power source when the LOAD button is pressed.

During transient execution, a progress indicator is visible showing percent completion.

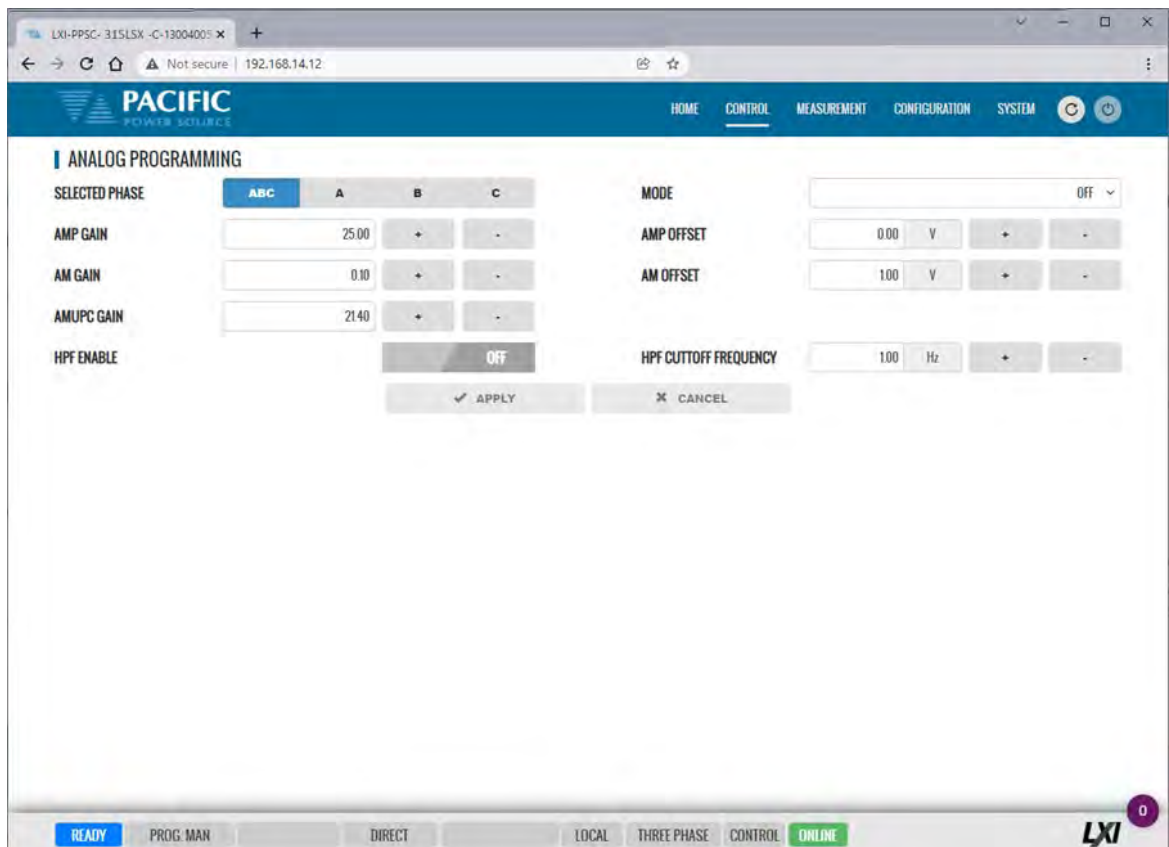
### 10.7.4 Analog Programming

The analog programming setup screen allows setting of the following functions:

- AMP      Amplifier Mode. An analog input signal is used to drive the output of each phase.
- AM        Amplitude Modulation. The output is modulated using the external analog input for each phase.
- ADD      The analog input is summed with the programmed output voltage and waveform
- AMUPC    Amplitude Modulation UPC Mode. This AM mode is compatible with the legacy PPC UPC controller AM function.

User settable values are Gain and Offset.

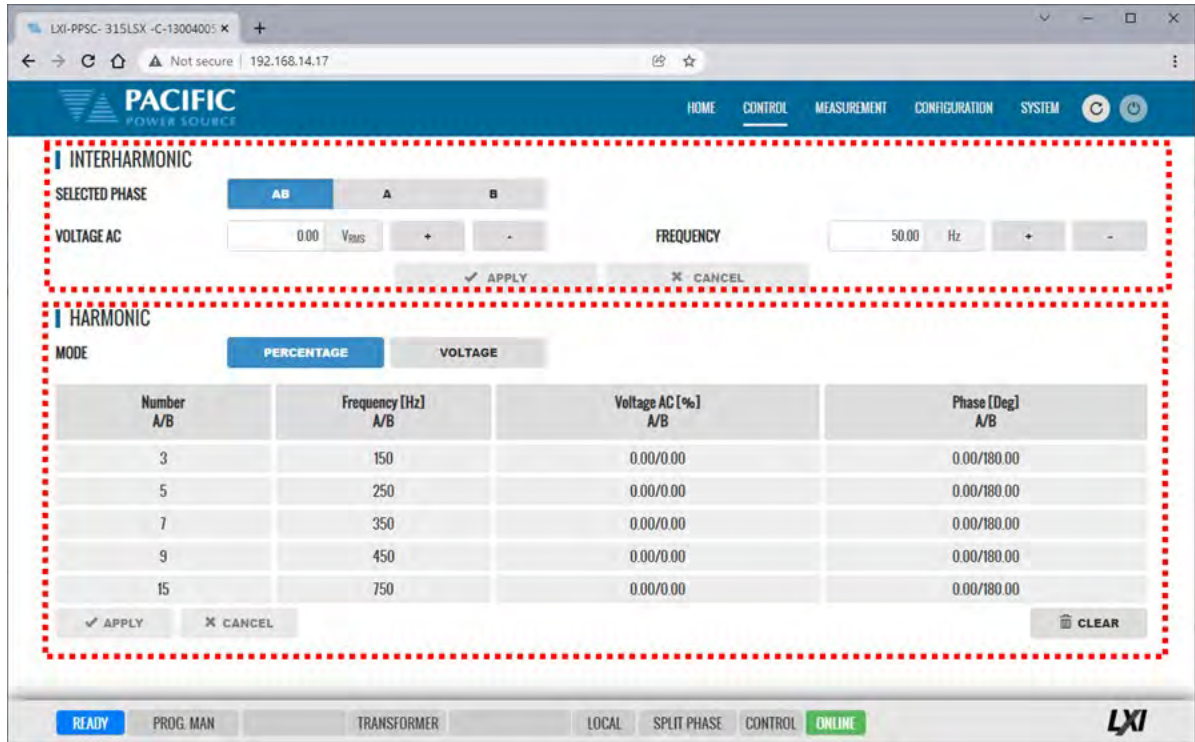
The Enable/Disable high pass filter applies to analog programming and blocks the DC (this may not be very relevant for AC coupled sources, but it has an effect in AM). It is disabled by default.



### 10.7.5 Interharmonic & Harmonic

This setup screen allows any interharmonic frequency and amplitude to be added to the output voltage. Maximum voltage settings is determined by the LSX maximum Vac rms and interharmonics frequency setting is range 15 ~ 10,000 Hz.

The HARMONIC section of this setup screen allows up to five harmonics component to be added to the output. These five individual harmonic amplitudes are tightly regulated. Each has its own voltage regulation loop and will produce more accurate harmonic output levels than using an arbitrary waveform.



The screenshot shows the LXI-PPSC-315LSX web interface. The browser address bar shows the URL 192.168.14.17. The interface has a blue header with the Pacific Power Source logo and navigation tabs: HOME, CONTROL, MEASUREMENT, CONFIGURATION, and SYSTEM. The main content area is divided into two sections, both highlighted with a red dashed border:

- INTERHARMONIC:** This section includes a 'SELECTED PHASE' dropdown menu with options 'AB', 'A', and 'B'. Below it is a 'VOLTAGE AC' input field set to '0.00 V<sub>RMS</sub>' and a 'FREQUENCY' input field set to '50.00 Hz'. There are '+' and '-' buttons for both fields. At the bottom of this section are 'APPLY' and 'CANCEL' buttons.
- HARMONIC:** This section has a 'MODE' dropdown menu with options 'PERCENTAGE' and 'VOLTAGE'. Below it is a table with the following data:
 

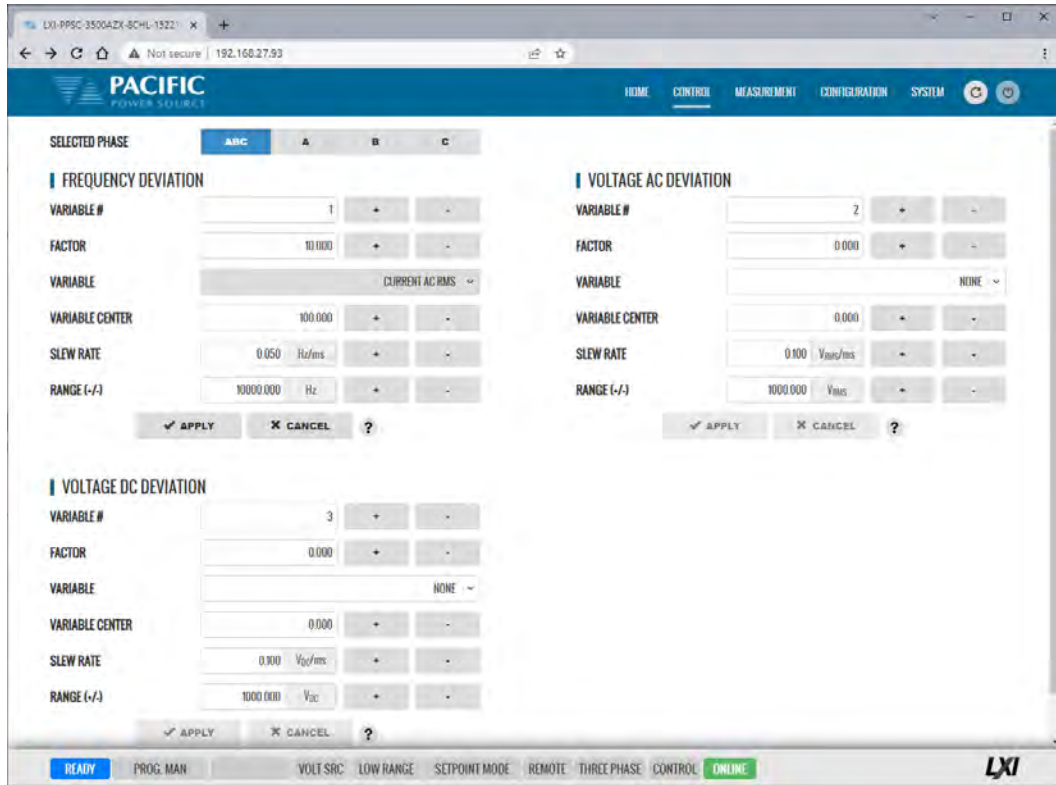
Number A/B	Frequency [Hz] A/B	Voltage AC [%] A/B	Phase [Deg] A/B
3	150	0.00/0.00	0.00/180.00
5	250	0.00/0.00	0.00/180.00
7	350	0.00/0.00	0.00/180.00
9	450	0.00/0.00	0.00/180.00
15	750	0.00/0.00	0.00/180.00

 At the bottom of this section are 'APPLY', 'CANCEL', and 'CLEAR' buttons.

At the bottom of the interface, there is a status bar with buttons for 'READY', 'PRG MAN', 'TRANSFORMER', 'LOCAL', 'SPLIT PHASE', 'CONTROL', and 'ONLINE'. The LXI logo is in the bottom right corner.

### 10.7.6 Setpoint Deviation

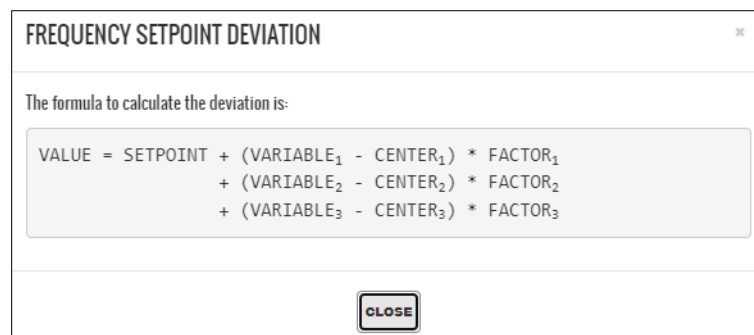
Deviation settings control how up to three user defined measurement values may be used to adjust either Frequency, Vac or Vdc output (or input in Load mode) settings of the power source/load around a center setting. Changes to these settings will be made at the slew rate set by the user as the selected measurement values change. This information is updated every 100 msec or at a rate of 10Hz. These settings can apply to all phases or individual settings for each phase can be set by the user.



#### Example

A “weak” power grid can be simulated by adjusting the Frequency setting as a function of the measured phase currents using this feature. For this case “ $F = F_0 - k \cdot I_{rms}$ ” with FACTOR  $k = 1$  for 1 Hz change for each Amp of current. Use the RANGE setting to constrain the max. allowed change and the SLEW RATE setting to avoid sudden setting jumps.

The ? button will display the general formula for all three variables:



This example shows the variation of the frequency based on the RMS current. Initially the frequency is 50 Hz at 1.0 ARMS. By applying the deviation, the measurement of the frequency is 25 Hz with an RMS current of 80.0 ARMS

**FREQUENCY DEVIATION**

VARIABLE #  + -

FACTOR  + -

VARIABLE  ▾

VARIABLE CENTER  + -

SLEW RATE  Hz/ms + -

RANGE (+/-)  Hz + -

*Parameters*

VALUE = 25.0 [Hz]  
 SETPOINT = 50.0 [Hz]  
 VARIABLE<sub>1</sub> = 80.0 [A<sub>RMS</sub>]  
 CENTER<sub>1</sub> = 1.0  
 $50.0 = 25.0 + (80.0 - 1.0) * \text{FACTOR}_1$   
 $\text{FACTOR}_1 = \frac{(25.0 - 50.0)}{(80.0 - 1.0)}$   
 FACTOR<sub>1</sub> = -0.316

Before:

**PROGRAM**

OUTPUT ENABLE

FREQUENCY  Hz + -

PHASE  ° + -

VOLTAGE AC  V<sub>RMS</sub> + -

VOLTAGE DC  V<sub>DC</sub> + -

CURRENT LIMIT  A<sub>RMS</sub> + -

POWER LIMIT  kW + -

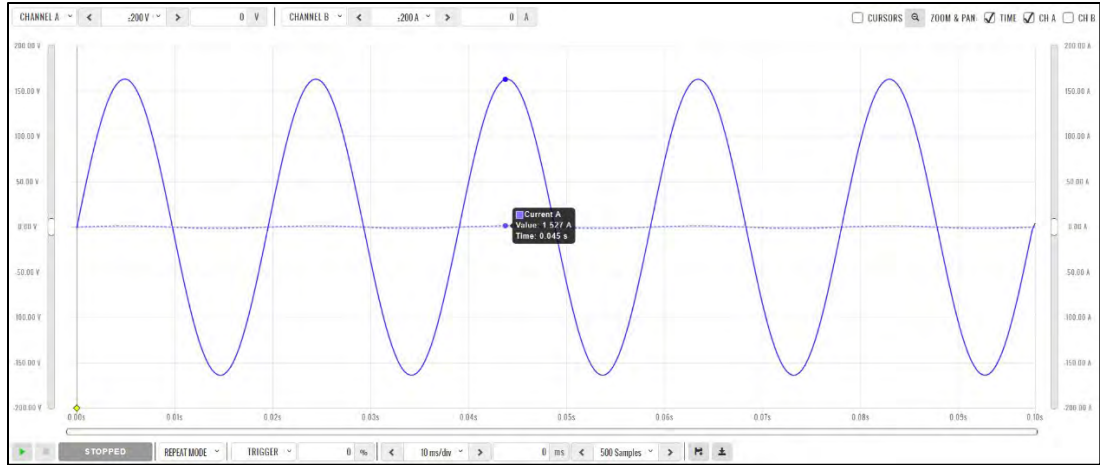
KVA LIMIT  kVA + -

**MEASUREMENTS**

FREQUENCY	49.98 Hz
VOLTAGE RMS (AC-DC)	115.87 V <sub>RMS</sub>
VOLTAGE RMS (AC)	115.87 V <sub>RMS</sub>
VOLTAGE THD	0.05 %
VOLTAGE DC	0.00 V <sub>DC</sub>
CURRENT RMS (AC-DC)	1.08 A <sub>RMS</sub>
CURRENT RMS (AC)	1.08 A <sub>RMS</sub>

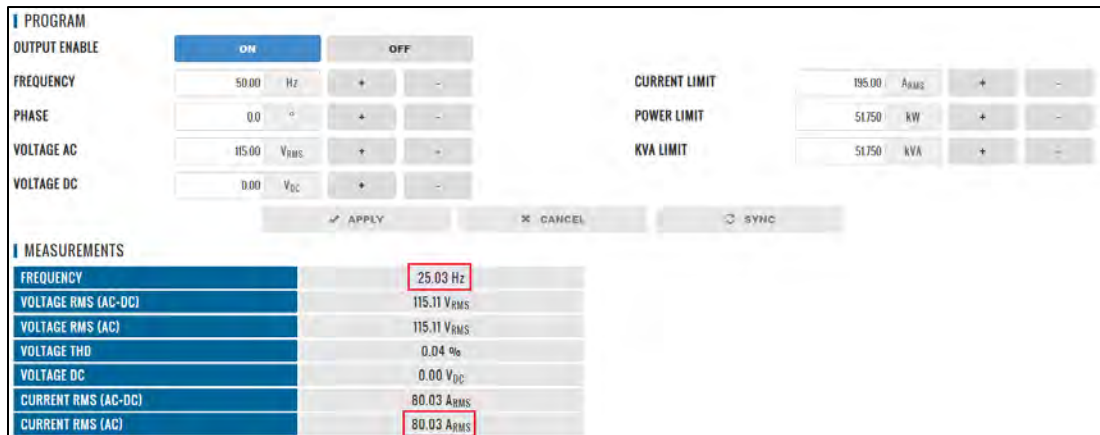
*Before deviation measurements*



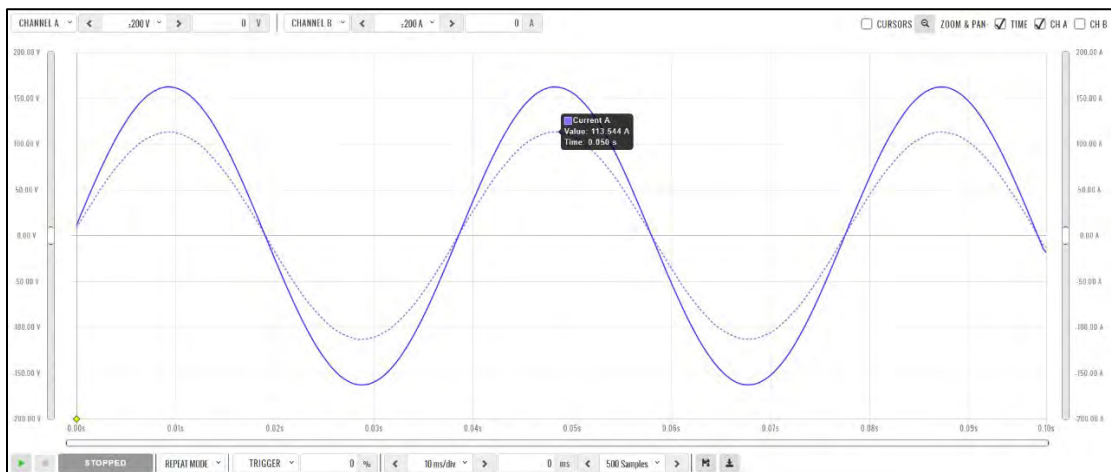


Before deviation capture

After:



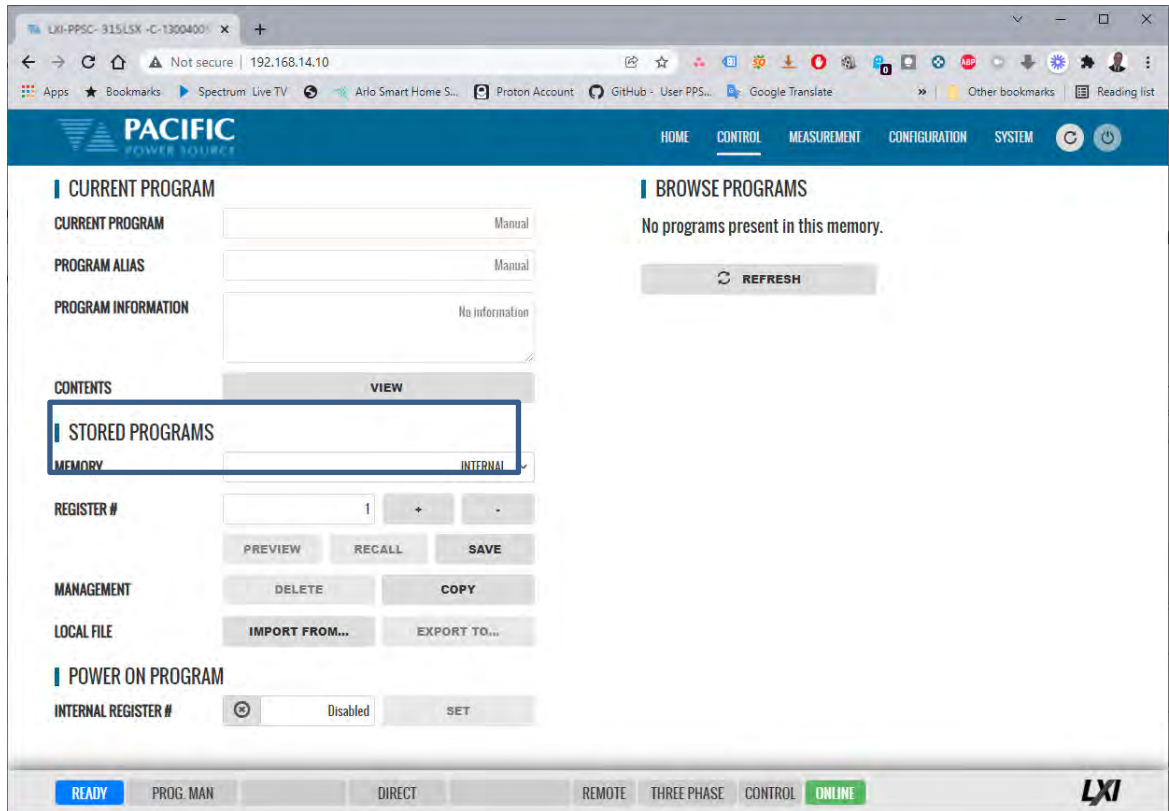
After deviation measurements



After deviation capture

### 10.7.7 Program Memory

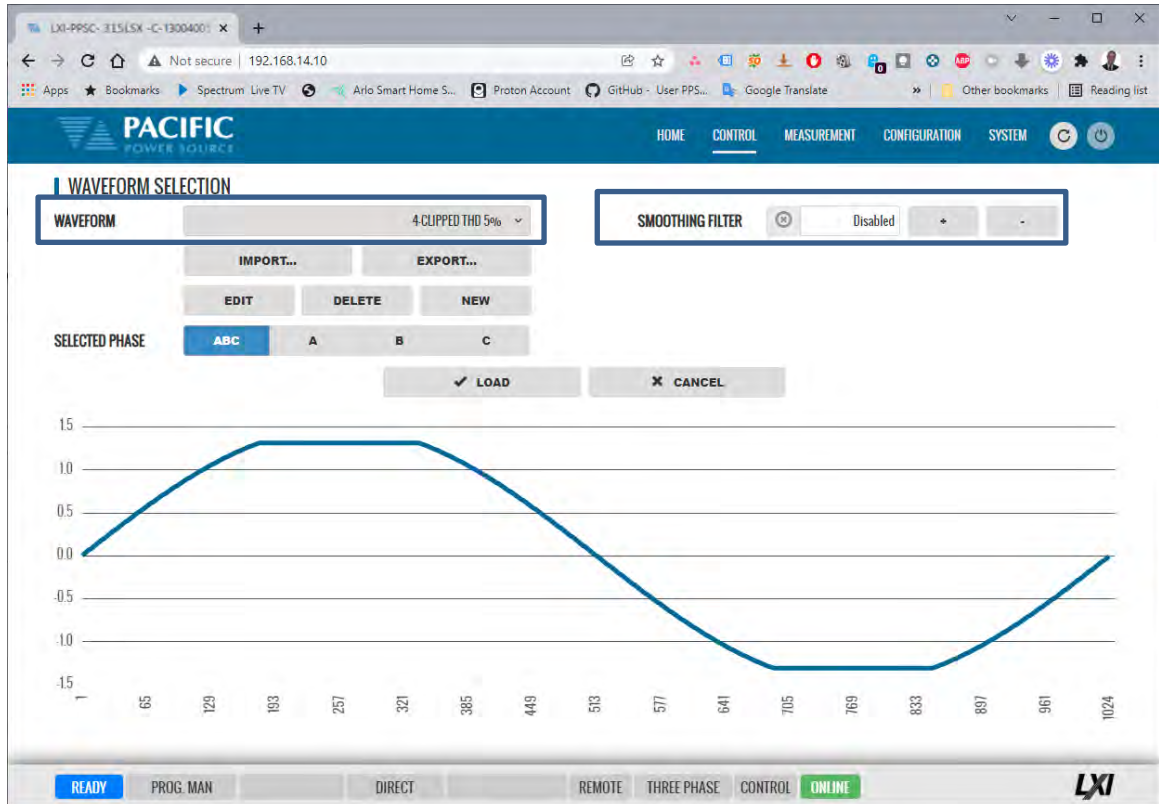
Program settings and transients can be stored in a number of different memory types. The Program Memory screen allows the user to manage available stored programs. The program to be recalled on power up can be selected at the bottom of this screen in the “POWER ON PROGRAM” area.



Note that external storage devices may be selected under “STORED PROGRAMS” using the MEMORY drop down list control.

### 10.7.8 Waveform

The power source supports a number of waveforms, most of which are user programmable arbitrary waveforms. The Waveform screen may be used to preview, select and download any of the waveforms stored in internal memory for output on one or more phases. The phase selection “ABC” or separate “A:”, “B” and “C” buttons on the upper right hand side are used to select all or an individual phase. The WAVEFORM drop down list will show all available waveforms.

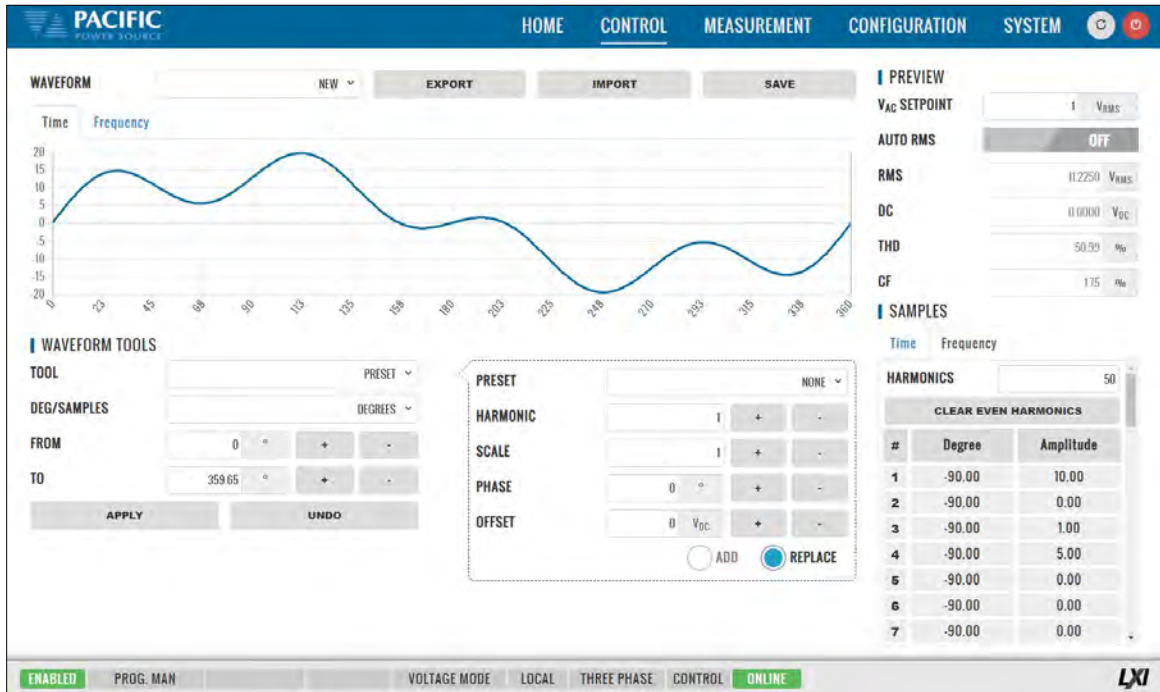


In addition to selecting the active waveform for output, the following controls are available to manage waveforms:

CONTROL	Purpose
<b>IMPORT....</b>	Import csv format waveform data files.
<b>EXPORT...</b>	Export selected waveform to csv format file
<b>EDIT...</b>	Access Waveform Edit screen to edit selected waveform. Also available from the CONTROL pull-down menu.
<b>DELETE</b>	Delete selected waveform. Note: Waveform 1-SINE cannot be deleted.
<b>NEW...</b>	Access the Waveform Edit screen to create a new waveform in the browser.

### 10.7.9 Waveform Editor

The waveform Editor function allows creation of custom waveforms. Each waveform records consists of 1024 data points (0.35° resolution). Data points can be indexed in Degrees or points. A value can be entered for each data point. There are several tools to generate harmonics, sum to a base sine wave or import a .csv file.



The following tools and controls are available in the Waveform Edit screen:

CONTROL	Purpose
<b>WAVEFORM</b>	Selects any available waveform to edit or select NEW to create a new waveform.
<b>EXPORT</b>	Export selected waveform to csv format file
<b>IMPORT</b>	Import csv format waveform data files.
<b>SAVE</b>	Saves selected waveform to power source memory
<b>SAMPLES</b>	Select no of data points used to defined wave shape. Available settings are 1024 through 2. For best definition, use 1024 data points. Lower point selections will result in interpolation of points in between. All waveforms are stored at 1024-point resolution. See examples on next page.
<b>PREVIEW</b>	
	<b>Vac SETPOINT:</b> Scales vertical axis to show voltage levels.
	<b>AUTO RMS:</b> Scales waveform levels to maintain Vac RMS value specified.
	<b>RMS:</b> Targeted Vac RMS level.
	<b>THD:</b> Shows total harmonic distortion in % of fundamental H1 for voltage waveform.
	<b>DC:</b> Targeted DC offset
	<b>CF:</b> Shows Crest Factor of voltage waveform.

10.7.9.1 Data Points

Waveform creation using direct data entry for each data point is faster when using fewer data points. Examples below show sine wave creation using either 16 or 4 data points. However, data is interpolated linearly for points not displayed in the table on the right hand side.

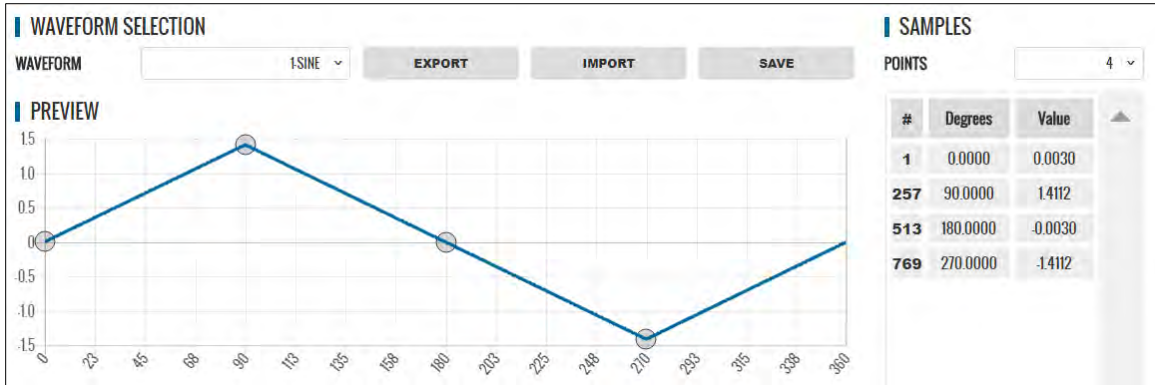


Figure 10-5: Waveform Edit defined using 4 data points

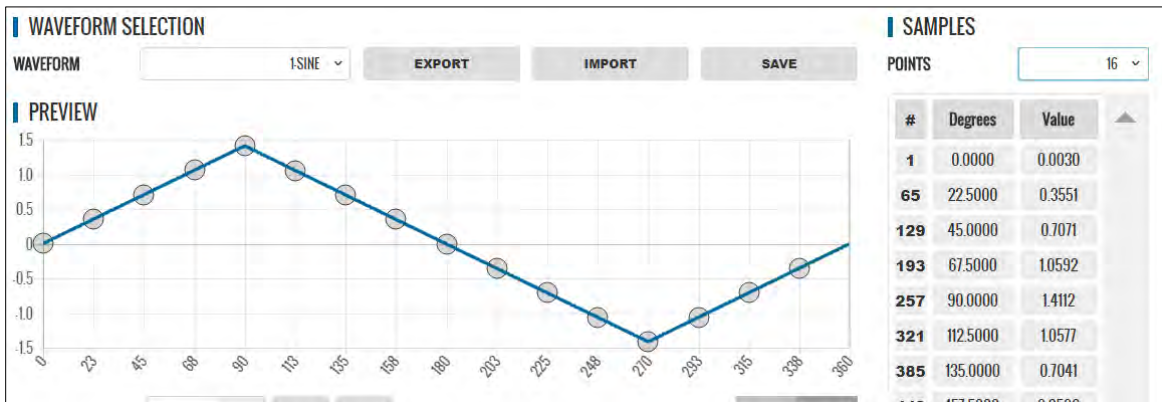


Figure 10-6: Waveform Edit defined using 16 data points

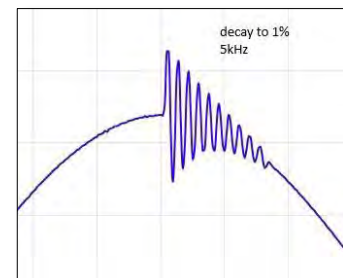
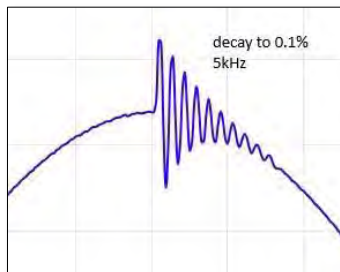
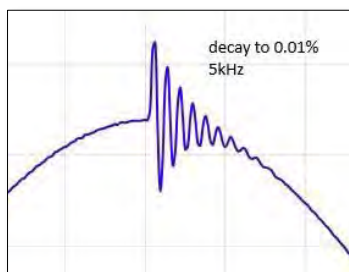
### 10.7.9.2 Waveform Tools

The following Waveform Tools are available:

CONTROL	Purpose
<b>TOOLS</b>	<p>These selections created specific waveform types without having to define data values manually. Following functions are available from this drop-down:</p> <p>NORMALIZE Normalizes waveform for zero DC offset.</p> <p>RECTIFY Rectifies the waveform. Only positive data points remain. This implies a DC offset which is shown in the DC display field below the graph.</p> <p>FREQ MULTIPLY Creates specified number of periods to multiply fundamental frequency. Use caution with resulting higher frequency waveforms as power source has a finite bandwidth and output may fault if too much high frequency content is present.</p> <p>OFFSET Applies specified DC offset.</p> <p>SCALE Multiplies all data points by scale factor value.</p> <p>VERTICAL FLIP Flips waveform vertically.</p> <p>HORIZONTAL FLIP Flips waveform horizontally.</p> <p>SMOOTHING FILTER Smooths sharp edges to reduce bandwidth requirements.</p> <p>PRESET Selects built-in waveform types based on user parameters.</p>
<b>PRESETS</b>	<p>The following PRESET waveforms are available:</p> <p>NONE Default or no selection made.</p> <p>SINE, TRIANGLE, SQUARE, 6 STEPS, 12 STEPS, SINE POWER, CLIPPED SINE, SAWTOOTH, PULSE, IMPORTED WAVEFORM</p>
<b>PARAMETERS</b>	<p>The following parameters are settable for each PRESET selection:</p> <p>HARMONIC H1 through H32</p> <p>SCALE Vertical Scale Multiplier</p> <p>PHASE Start phase angle</p> <p>OFFSET DC Offset</p> <p>EXPONENT 1 through 51. Applies to SINE POWER present only.</p> <p>THD 0% through 100%. Applies to CLIPPED SINE only.</p> <p>RISE TIME 0° through 360°. Applies to PULSE preset only.</p> <p>PULSE WIDTH 0° through 360°. Applies to PULSE preset only.</p> <p>FALL TIME 0° through 360°. Applies to PULSE preset only.</p> <p>LOAD FROM FILE Available for IMPORTED WAVEFORM preset only.</p> <p>ADD Add to existing waveform (summation)</p> <p>REPLACE Replace existing waveform with selected PRESET</p>

#### Example for UL 2231-2 Ringwave Test Waveform Creation.

This immunity test superimposes a decaying sine amplitude on an AC 50Hz or 60Hz line voltage at frequencies of 1kHz, 2kHz, 3kHz, 4kHz and 5kHz. This example shows how to add the 5kHz ring wave to a standard sinewave voltage using the Waveform Editor in the web browser interface.



From the Tools menu on the left, select the **RING WAVEFORM** type. The following parameters can be set to create the desired ring wave voltage waveform:

- DECAY:** Represents the decay constant based on the final amplitude value of the ringing signal (1%, 0.1% or 0.01%) of the initial amplitude.
- RING FRQUENCY** This is the frequency multiplier of the base frequency.
- RING AMPLITUDE** This is the (Ringing initial amplitude/Base signal amplitude) ratio.
- DEG (FROM / TO)** Determines the phase angle for the start and end of the ringing signal, as shown in this example, 126-90=36 which is 10% Of the 360° period.



The waveform created using the editor can be downloaded to the power source using the **SAVE** button. Once loaded, the internal advanced scope function in the web browser interface can be used to capture the actual output waveform as shown below.



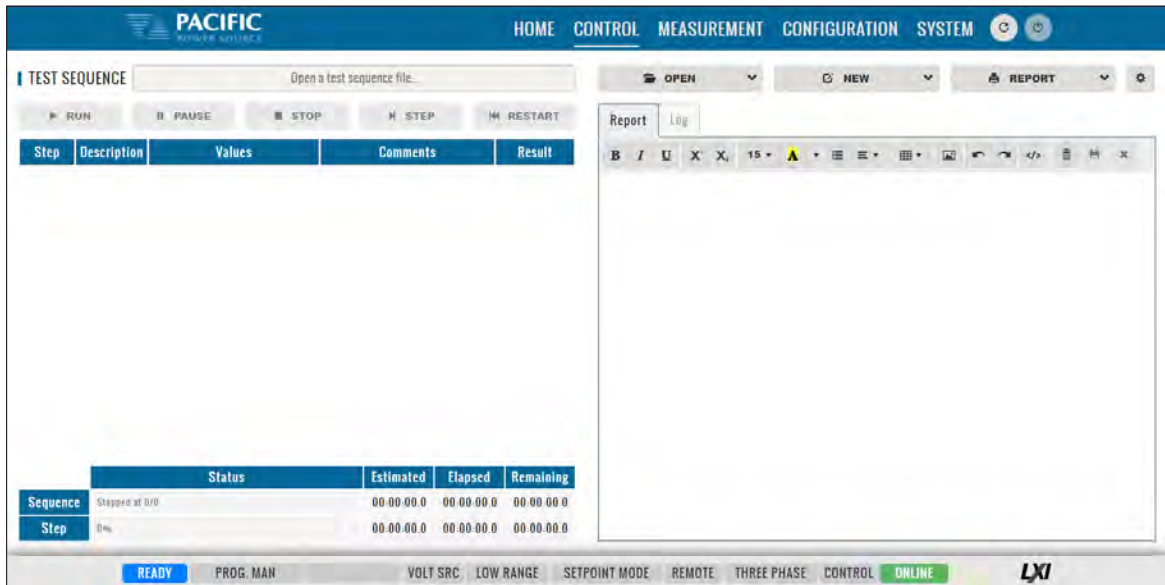


### 10.7.10 Test Sequence

The test sequence feature can be found on the webpage CONTROL menu under “TEST SEQUENCE”. **Note** that this function requires firmware revision 3.7.x or higher.

CONTROL -> TEST SEQUENCE.

It is off by default to save unit memory and takes a few seconds to start once the Test Sequence screen is open the first time after power on.



A Test Sequence consists of a group of steps that are executed sequentially. Each step logs the details of said step to a test report. After test execution, this test report can be downloaded or printed using the browser interface.

A Test Sequence step can be any of the following types:

- Configuration
- Steady state
- Transient
- Timer (To perform a delay)
- User prompt (Show information)
- Meter (Performs different measurements)
- Control (Power source control shortcut)
- User input
- Script (For custom procedures, the coding language is Javascript)
- SCPI list (Executes a list of SCPI commands)
- SCPI (Executes a SCPI command)

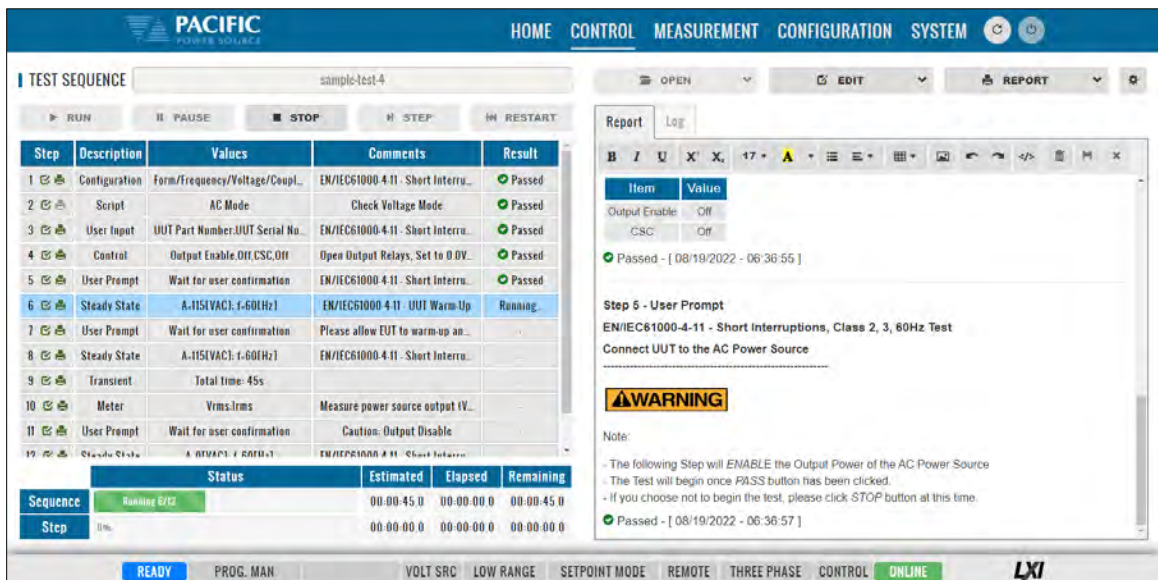
Note that the sequence engine runs on the power source controller. The browser based webpage only acts as the graphical user interface for test sequence development, execution and reporting. As such, the browser can be closed and reopened without losing any of the test sequence information.

The test sequence functions can also be fully controlled remotely using SCPI commands and the sequences can be stored in the power sources' nonvolatile flash memory. The file format is the industry standard 7z extension compressed file format.

To familiarize yourself with test sequence use and operation, it is recommended to study the four example files provided:

- Sample-test-1.7z
- Sample-test-2.7z
- Sample-test-3.7z
- Sample-test-4.7z

For example, sample-test number 4 performs an IEC 61000-4-11 short voltage interrupt test on any number of user selectable phases. It's content is shown in the browser screen below.



Step	Description	Values	Comments	Result
1	Configuration	Form/Frequency/Voltage/Coupl...	EN/IEC61000-4-11 - Short Interru...	Passed
2	Script	AC Mode	Check Voltage Mode	Passed
3	User Input	UUT Part Number,UUT Serial No.	EN/IEC61000-4-11 - Short Interru...	Passed
4	Control	Output Enable,Off,CSC,Off	Open Output Relays, Set to 0.0V.	Passed
5	User Prompt	Wait for user confirmation	EN/IEC61000-4-11 - Short Interru...	Passed
6	Steady State	A-115(VAC), f-60(Hz)	EN/IEC61000-4-11 - UUT Warm Up	Running
7	User Prompt	Wait for user confirmation	Please allow EUT to warm-up an...	
8	Steady State	A-115(VAC), f-60(Hz)	EN/IEC61000-4-11 - Short Interru...	
9	Transient	Total Time- 45s		
10	Meter	Vrms,Irms	Measure power source output IV...	
11	User Prompt	Wait for user confirmation	Caution: Output Disable	

Sequence	Status	Estimated	Elapsed	Remaining
Sequence	Running 67%	00:00:45.0	00:00:00.0	00:00:45.0
Step	11%	00:00:00.0	00:00:00.0	00:00:00.0

**Report** Log

Item	Value
Output Enable	Off
CSC	Off

Passed - [ 08/19/2022 - 06:36:55 ]

**Step 5 - User Prompt**  
EN/IEC61000-4-11 - Short interruptions, Class 2, 3, 80Hz Test  
Connect UUT to the AC Power Source

**WARNING**

Note:  
- The following Step will **ENABLE** the Output Power of the AC Power Source  
- The Test will begin once **PASS** button has been clicked.  
- If you choose not to begin the test, please click **STOP** button at this time.

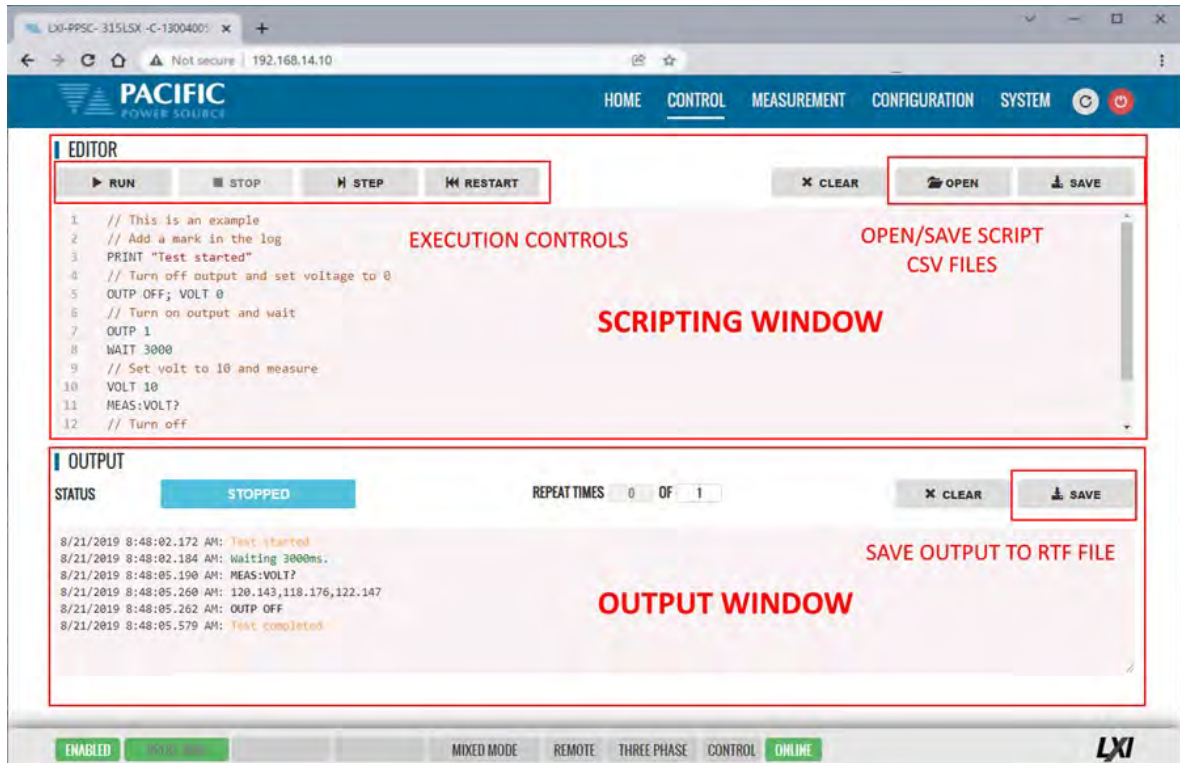
Passed - [ 08/19/2022 - 06:36:57 ]

For an overview of the available Test Sequence SCPI control command syntax, refer to the Remote Control Programming Section of this manual. (Section 8.11).

### 10.7.11 SCPI Script

The SCPI Script menu entry displays the command scripting screen. These user generated scripts can contain any sequence of SCPI commands, comments and output statements to automate simple repetitive tasks. Scripts may be used to automate repetitive tasks more quickly and are simpler to write than an actual application program.

A script can be saved to the PC or tablet on which the browser runs.



#### 10.7.11.1 Supported Keywords and Commands

The following script entries are supported:

Entry Type	Description
<b>USER COMMENT</b>	// Any test preceded by a two forward slash characters
<b>PRINT</b>	Sends text strings after PRINT key word to the OUTPUT window located at the bottom half of the browser window.
<b>WAIT</b>	Pauses script execution by no of msec specified.
<b>SCPI COMMAND</b>	Any support SCPI command. Data returned by a query command (?) will be printed in the output window.

Table 10-1: Supported Script Entries

#### 10.7.11.2 Script Execution Control

To run a script, click the ► **RUN** button in the upper left corner of the Editor window. You can also single step through a script during development using the ► | **STEP** button. The ■ **STOP** button will abort execution of a running script. To run a script multiple times, set the REPEAT TIMES value to a value higher than the default 1 (one). Max. repeat count is 1e+54.

### 10.7.11.3 Managing multiple script files.

Script files can be saved to the PC or device on which the browser runs, i.e. Windows PC, Tablet, or Smartphone. Use the **OPEN** and **SAVE** buttons in the upper right corner of the Editor window to save and retrieve scripts. Scripts are saved in Comma Separated File format, which can be edited in Excel or any text editor like Notepad. The sample script csv file content (*scpi\_script.csv*) is shown below. When saving a new script, replace the default scpi\_script file name with a more descriptive file name.

```
// Available commands are:  
// - WAIT MILISECONDS, example -> WAIT 2000  
// - PRINT "TEXT", example -> PRINT "Test started"  
// - SCPI COMMAND/s, example -> OUTP OFF; VOLT 0  
// Comments starts with // as this line  
// The following is an example  
// Add a mark in the log  
PRINT "Test started"  
// Turn off output and set voltage to 0  
OUTP OFF; VOLT 0  
// Turn on output  
OUTP 1  
// Wait three seconds  
WAIT 3000  
// Set output voltage to 10 volts  
VOLT 10  
// Get output voltage measurement  
MEAS:VOLT?  
// Turn off  
OUTP OFF  
PRINT "Test completed"
```

### 10.7.11.4 Script Execution Output

The OUTPUT window located in the bottom half of the browser window shows all script output, including any user comments, events like script start and stop as well as any PRINT commands. Each output entry is date and time stamped.

The content of the **OUTPUT** window can be saved to a Rich Text File using the **SAVE** button in the upper right corner of the OUTPUT window. (Do not confuse with the SAVE button in the script EDITOR window.) The default output file name is "*scpi\_script\_output.rtf*". A sequence number (1), (2) etc will be appended each time the output window content is saved.

A sample RFT file is shown below.

```
8/21/2019 8:48:02.172 AM: Test started  
8/21/2019 8:48:02.184 AM: Waiting 3000ms.  
8/21/2019 8:48:05.190 AM: MEAS:VOLT?  
8/21/2019 8:48:05.260 AM: 120.143,118.176,122.147  
8/21/2019 8:48:05.262 AM: OUTP OFF  
8/21/2019 8:48:05.579 AM: Test completed
```

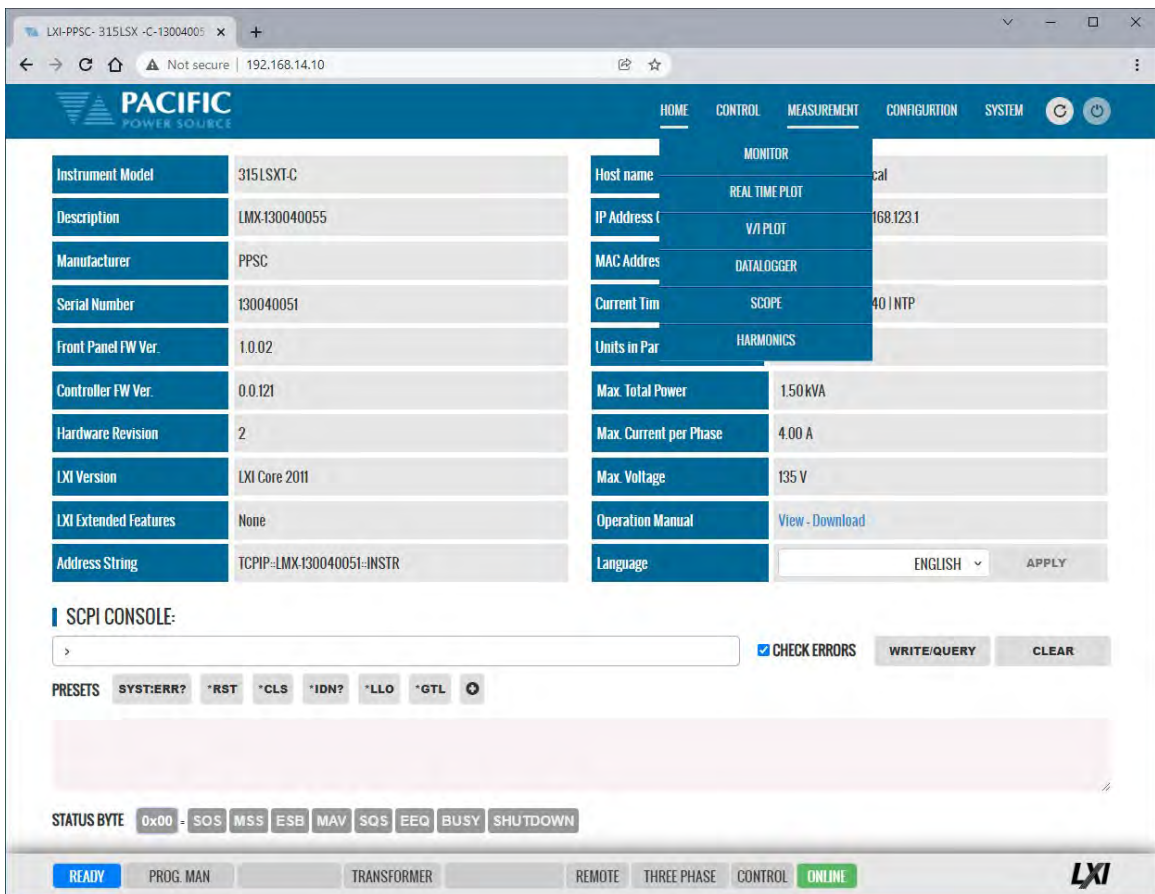
**Note:** All output files are saved to the default Download directory determined by the Browser setting.

## 10.8 Measurement Screens

The MEASUREMENT menu provides access to several measurement screens. Measurement screens available are:

- MONITOR
- REAL TIME PLOT
- WAVEFORMS
- V/I PLOT
- DATALOGGER
- SCOPE
- HARMONICS

Each is described in subsequent sections.



The screenshot shows the LXI-PPSC web interface for a 315LSX-C power source. The browser address bar shows the IP address 192.168.14.10. The navigation menu includes HOME, CONTROL, MEASUREMENT, CONFIGURATION, and SYSTEM. The MEASUREMENT menu is expanded, showing options for MONITOR, REAL TIME PLOT, V/I PLOT, DATALOGGER, SCOPE, and HARMONICS. The main content area displays system information in two columns:

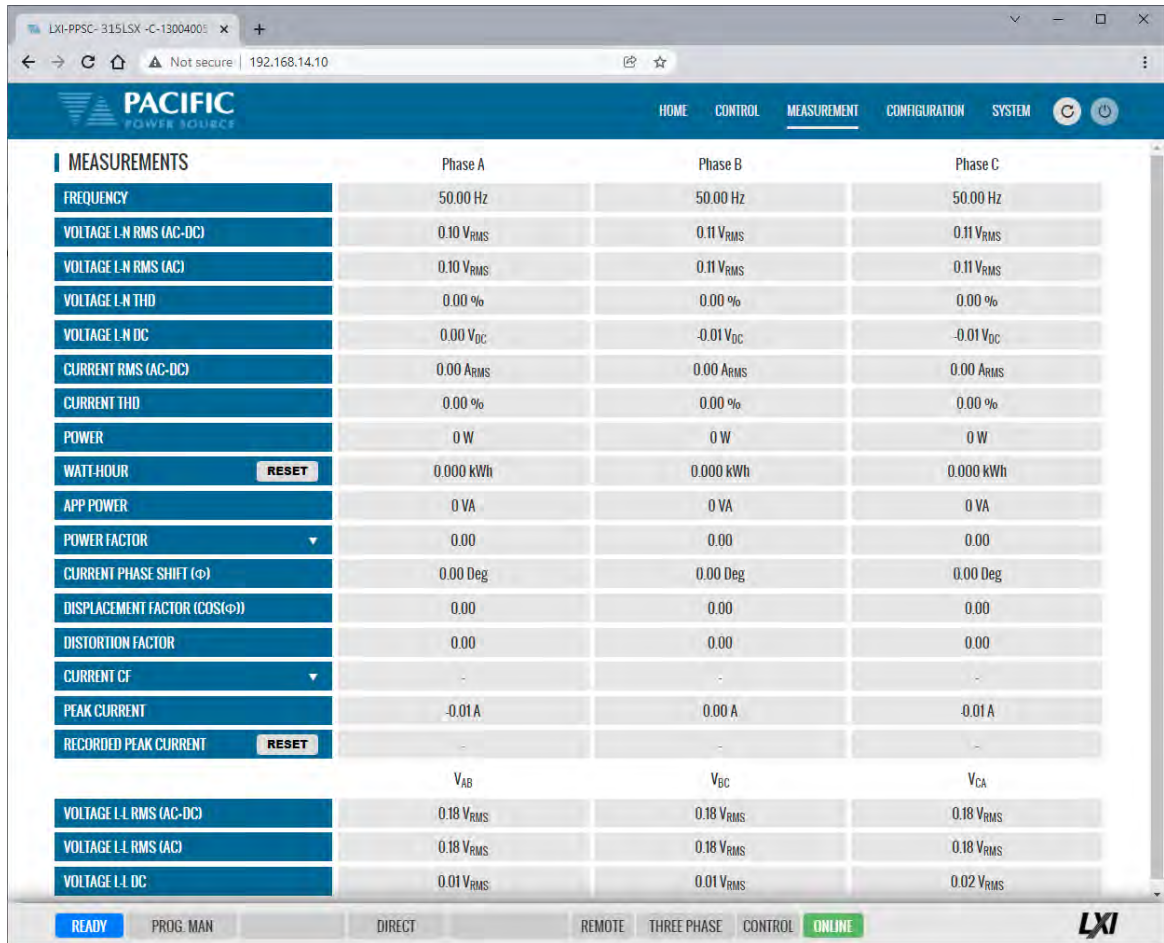
Instrument Model	315LSX-C	Host name	local
Description	LMX130040055	IP Address	192.168.123.1
Manufacturer	PPSC	MAC Address	
Serial Number	130040051	Current Time	10/11/2011
Front Panel FW Ver.	1.0.02	Units in Par	
Controller FW Ver.	0.0.121	Max. Total Power	1.50 kVA
Hardware Revision	2	Max. Current per Phase	4.00 A
LXI Version	LXI Core 2011	Max. Voltage	135 V
LXI Extended Features	None	Operation Manual	<a href="#">View - Download</a>
Address String	TCPIP=LMX130040051-INSTR	Language	ENGLISH <input type="button" value="APPLY"/>

Below the system information is the SCPI CONSOLE section, which includes a command input field, a  CHECK ERRORS button, and buttons for WRITE/QUERY and CLEAR. There are also PRESETS buttons for SYST:ERR?, \*RST, \*CLS, \*IDN?, \*LLO, and \*GTL. At the bottom, the STATUS BYTE is displayed as 0x00, with buttons for SOS, MSS, ESB, MAV, SQS, EEQ, BUSY, and SHUTDOWN. The bottom status bar shows the power source is in the READY state and is ONLINE.

### 10.8.1 Monitor

The measurement monitor screen replicates part of the CONTROL->PROGRAM screen and displays all measurement data for all available output phases. Measurements include both AC and DC components.

**Note:** There are no controls on this screen except for the Output Off button and RESET buttons for Watt-Hour and Recorded Peak Current measurements.

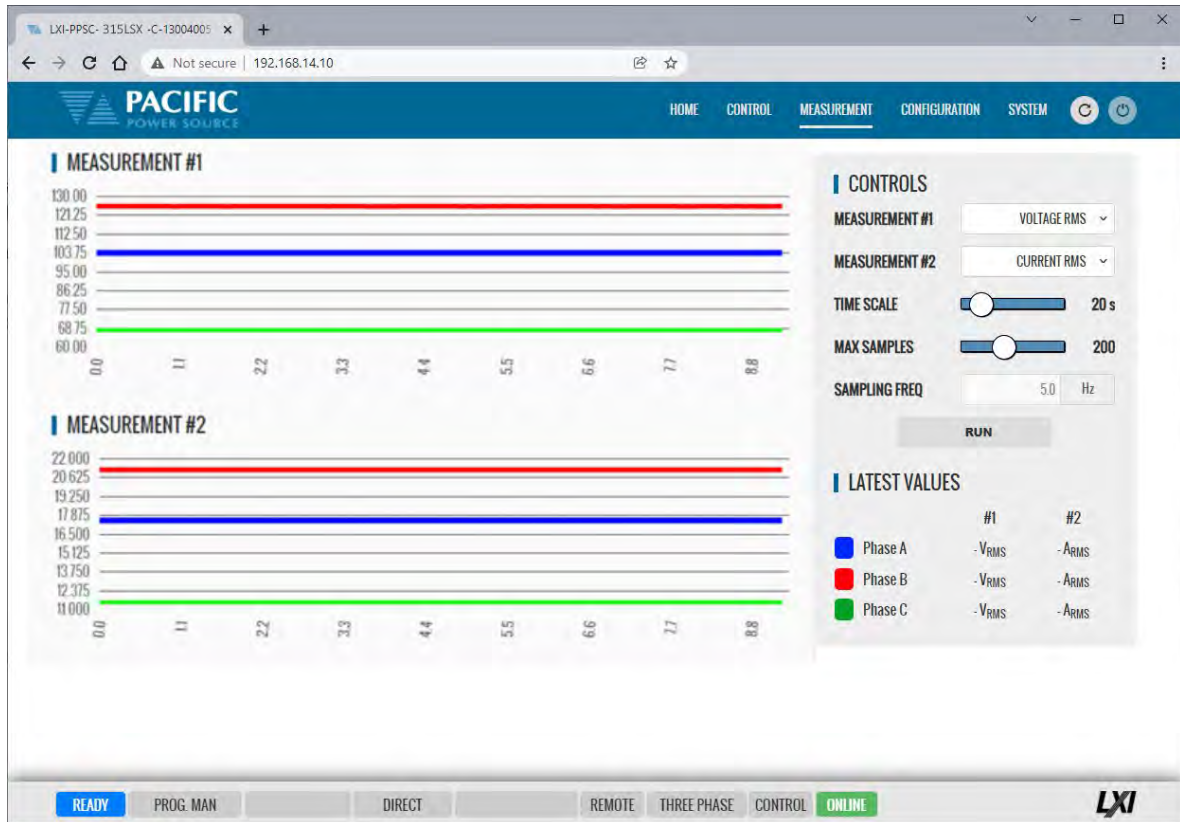


	Phase A	Phase B	Phase C
FREQUENCY	50.00 Hz	50.00 Hz	50.00 Hz
VOLTAGE L-N RMS (AC-DC)	0.10 V <sub>RMS</sub>	0.11 V <sub>RMS</sub>	0.11 V <sub>RMS</sub>
VOLTAGE L-N RMS (AC)	0.10 V <sub>RMS</sub>	0.11 V <sub>RMS</sub>	0.11 V <sub>RMS</sub>
VOLTAGE L-N THD	0.00 %	0.00 %	0.00 %
VOLTAGE L-N DC	0.00 V <sub>DC</sub>	-0.01 V <sub>DC</sub>	-0.01 V <sub>DC</sub>
CURRENT RMS (AC-DC)	0.00 A <sub>RMS</sub>	0.00 A <sub>RMS</sub>	0.00 A <sub>RMS</sub>
CURRENT THD	0.00 %	0.00 %	0.00 %
POWER	0 W	0 W	0 W
WATT-HOUR <span>RESET</span>	0.000 kWh	0.000 kWh	0.000 kWh
APP POWER	0 VA	0 VA	0 VA
POWER FACTOR	0.00	0.00	0.00
CURRENT PHASE SHIFT (φ)	0.00 Deg	0.00 Deg	0.00 Deg
DISPLACEMENT FACTOR (COS(φ))	0.00	0.00	0.00
DISTORTION FACTOR	0.00	0.00	0.00
CURRENT CF	-	-	-
PEAK CURRENT	-0.01 A	0.00 A	-0.01 A
RECORDED PEAK CURRENT <span>RESET</span>	-	-	-
	V <sub>AB</sub>	V <sub>BC</sub>	V <sub>CA</sub>
VOLTAGE L-L RMS (AC-DC)	0.18 V <sub>RMS</sub>	0.18 V <sub>RMS</sub>	0.18 V <sub>RMS</sub>
VOLTAGE L-L RMS (AC)	0.18 V <sub>RMS</sub>	0.18 V <sub>RMS</sub>	0.18 V <sub>RMS</sub>
VOLTAGE L-L DC	0.01 V <sub>RMS</sub>	0.01 V <sub>RMS</sub>	0.02 V <sub>RMS</sub>

READY    PROG MAN    DIRECT    REMOTE    THREE PHASE    CONTROL    ONLINE    LXI

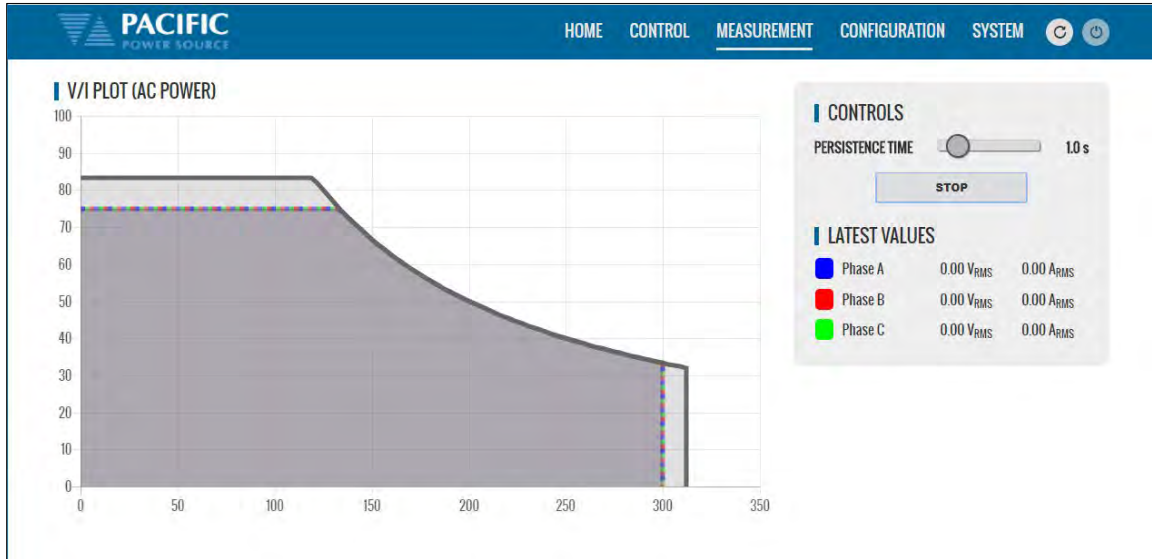
### 10.8.2 Real-Time Plot

This measurement screens provides a strip-chart style graphical display for up to two measurement parameters, #1 and #2. The CONTROLS are allows selection of the desired parameter for each graph. Available choices are Voltage, Current and Power. Depending on phase mode, up to three phase values are displayed per chart.



### 10.8.3 V/I Plot

The V/I plot shows the power operating point at any moment in time by plotting measured Voltage as a function of measured Current. This plot has a persistence mode so the user can observe power fluctuations and changes over a set period.



Available selections in this measurement screen are:

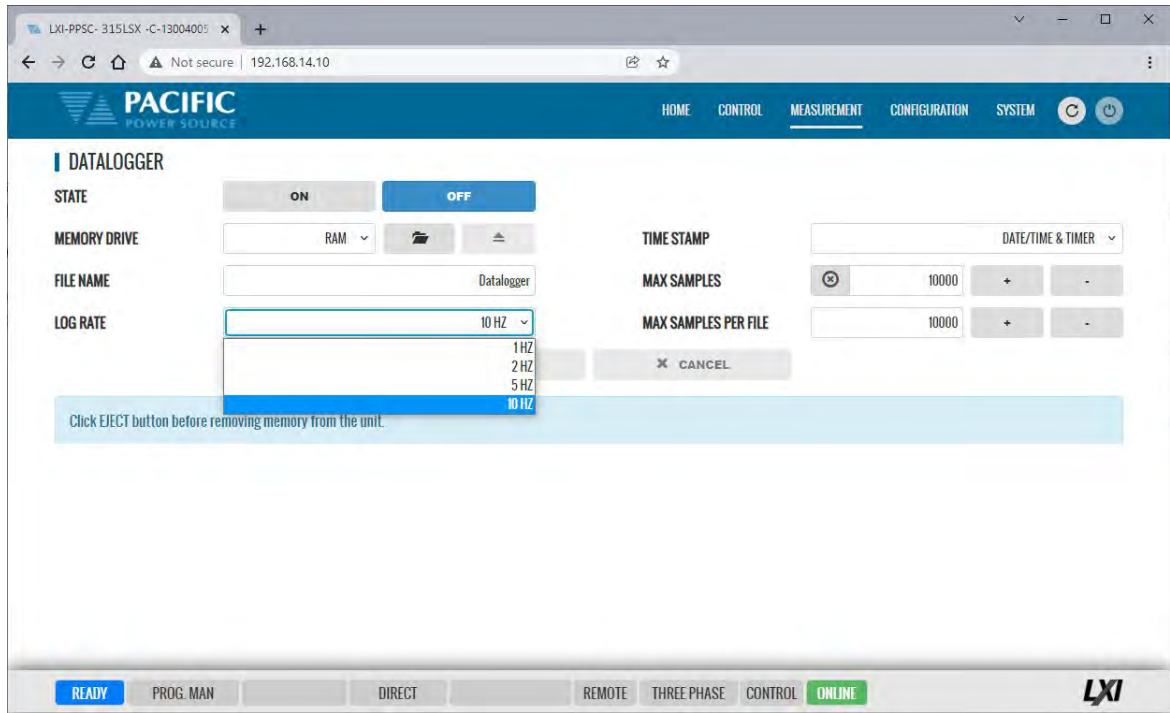
- Persistence Time: 1 ~ 60 sec



### 10.8.4 Data Logger

The measurement data logger screen allows measurement data to be written to a memory device, using a comma delimited file format. These files are easy to open in an Excel™ spreadsheet or other math oriented software program.

Available controls are for State on/off, memory destination device, file name assignment and data logging rate in Hz. All file entries are time stamped.



### 10.8.5 Scope

There are two Scope Measurement screen with different levels of functionality. The Basic Scope function is most suitable to get a quick view of either voltage and or current waveforms on one of more output phase. The Advanced scope function offers many more settings, memory depth, programmable capture settings and trigger capabilities at the cost of have to set up more parameters to get the data you want.

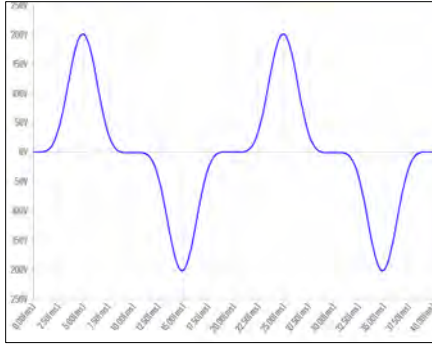
#### 10.8.5.1 Scope - Basic

The Scope function captures voltage and current waveforms at the output of the power source on all phases. This screen allows a variety of captured waveforms to be displayed. Anywhere from one to four periods of the output voltage and/or current can be captured and displayed. The amplitude axis auto-scales so no horizontal or vertical settings have be made by the user. This makes this scope mode quick and easy to use.

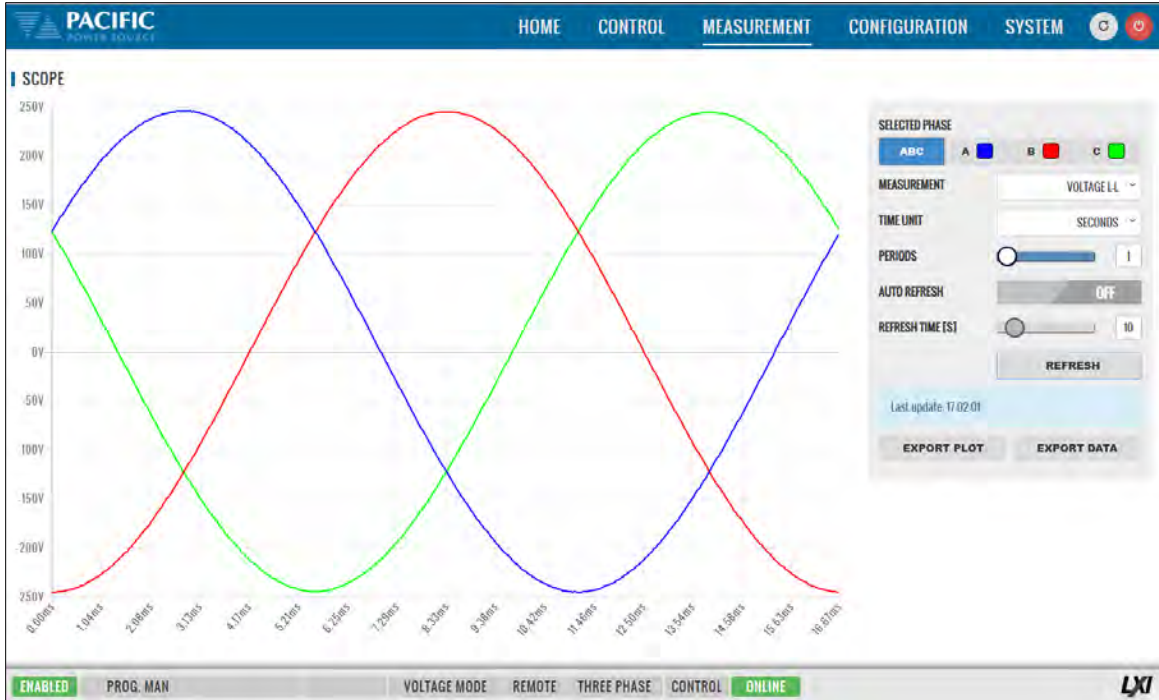


The following controls are available to customize the captured waveform display:

CONTROL	Purpose
MEASUREMENT	Selects Voltage L-N, Voltage L-L, Current or Both Voltage & Current
PHASE	Selects Phase A, B, C or all (ABC). Only visible in two or three phase mode.
TIME UNIT	Selects time scale in either TIME, SAMPLES or PHASE
PERIODS	Selects the number of periods to display. Range is 1~ 4
AUTO REFRESH	Turns AUTO REFRESH mode ON or OFF
REFRESH PERIOD	Sets interval time for AUTO REFRESH mode in seconds. Range is 5 ~ 100.
REFRESH	Manual REFRESH button
EXPORT GRAPH	Downloads image for displayed waveform(s). See sample below.
EXPORT DATA	Downloads captured data points for displayed waveform(s) in csv format text file. See sample below.

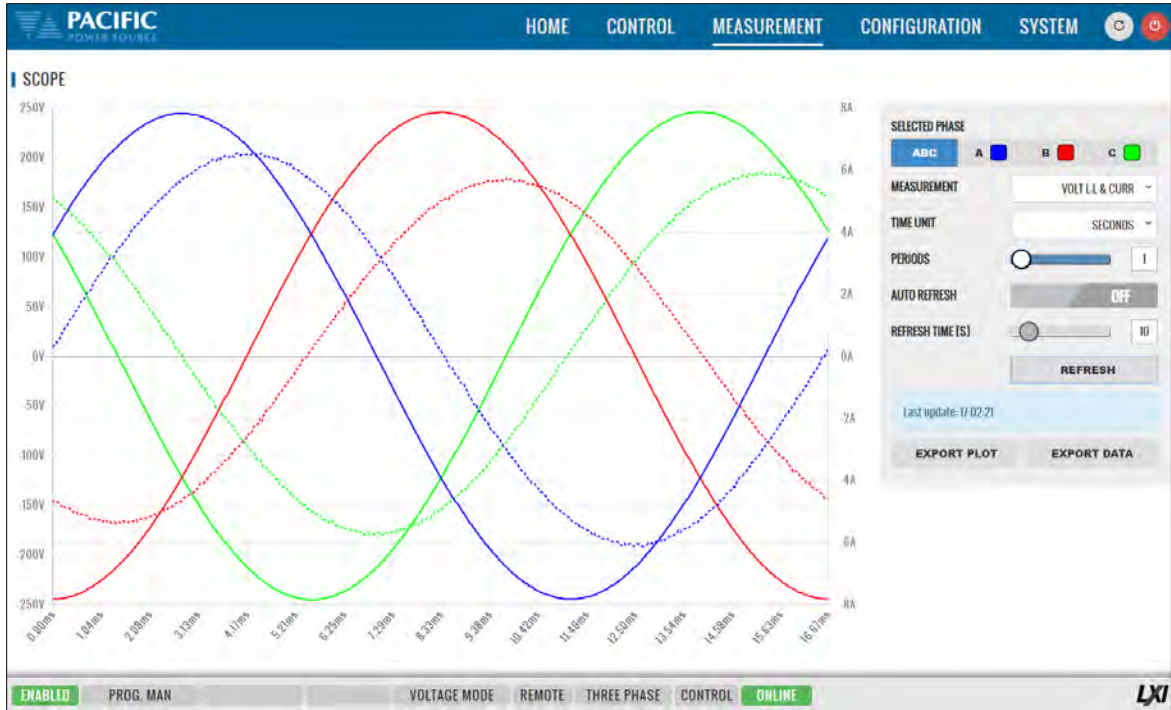


Sample	Degrees	Time[s]	Phase A - Voltage[V]
1	0	0	-0.12
2	0.7	3.91E-05	0.05
3	1.41	7.81E-05	0.02
4	2.11	0.000117	-0.1
5	2.81	0.000156	-0.03
6	3.52	0.000195	0



Line to Line capture for all phases.

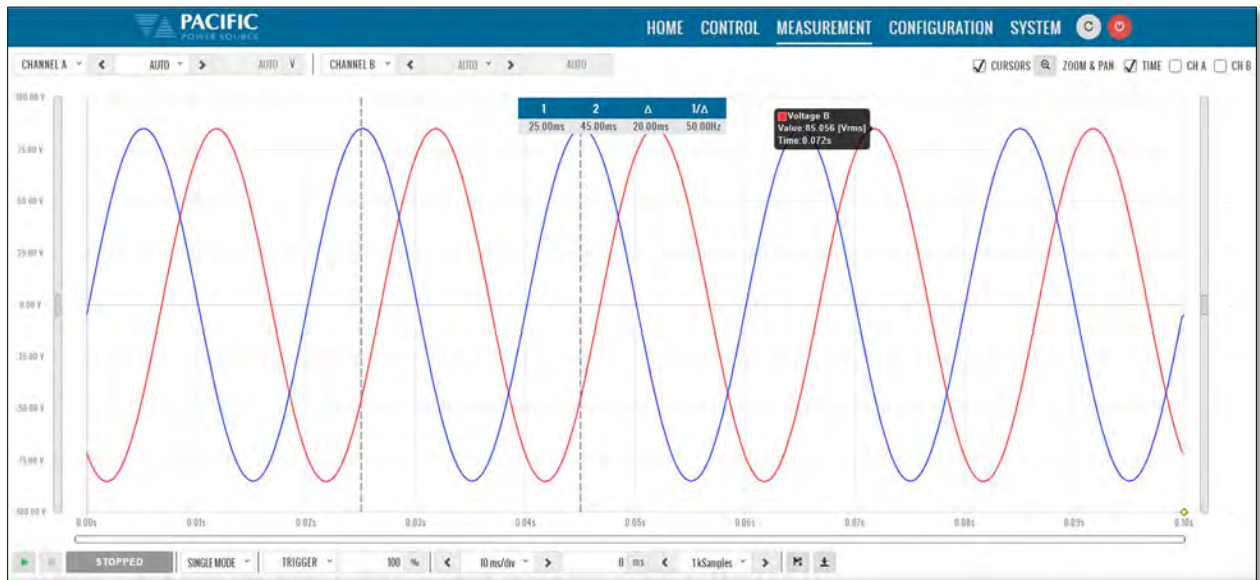
Voltage and Current can be displayed in one scope screen:































### 10.8.5.2 Scope – Advanced

The ADVANCED scope function operates much the same as a digital storage oscilloscope having controls for time base, attenuators and trigger mode settings. The amount of data points that can be captured and stored ranges from 100 Samples to 1,000,000 samples (1Ms).

The advanced scope function has two channel, labeled CHANNEL A and CHANNEL B. Each channel can be assigned to capture either voltage or current on any of the available output phases. Vertical scaling can be set as well as DC offset for each channel as needed.

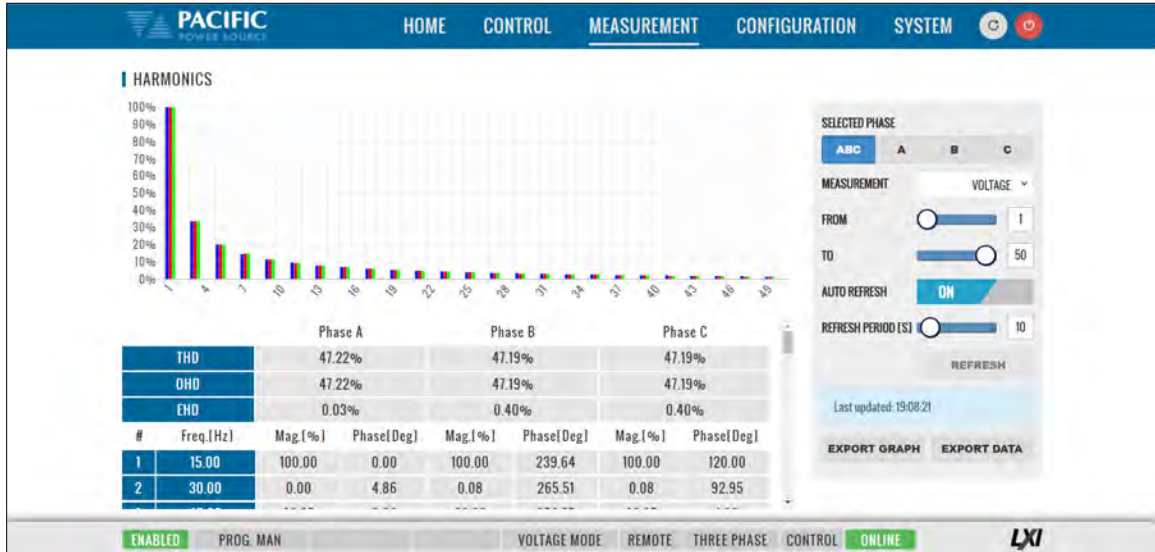


Settings and ranges are detailed in the table bellows.

CONTROL		Purpose
         		
<b>CHANNEL A</b>	Input	Selects output phase and parameter to be captured on Channel A. Available phase vary by model: (Phase A for Single phase, Phase A or B in Split phase, Phase A, B or C in Three phase mode.
	Attenuator	Sets input amplitude scaling from 1V/div to 200V/div. Also available is AUTO scaling or channel OFF.
	DC Offset	This setting sets DC Offset or AUTO for auto DC offset compensation.
<b>CHANNEL B</b>		Same as Channel A but for B Channel
<input checked="" type="checkbox"/> CURSORS  ZOOM & PAN: <input checked="" type="checkbox"/> TIME <input type="checkbox"/> CH A <input type="checkbox"/> CH B		
<b>CURSORS</b>	Check	Check ON to display on screen cursors. When Enabled, two cursors are displayed using dashed vertical lines. Cursors are 1 and 2. Also shown is delta- T and 1/delta T. Use the mouse or touch screen to move the cursors.
	Zoom & Pan	Available selections are: <ul style="list-style-type: none"> <li>• Time</li> <li>• CH A</li> <li>• CH B</li> </ul>
            		
<b>RUN / STOP</b>	Acquisition	The Green Run button is location in the lower left corner. A Stop button is located right next to it. The Stop button will be enabled while an acquisition is in progress. The acquisition status is shown to the right of the Stop button as either: <ul style="list-style-type: none"> <li>• RUNNING</li> <li>• WAITING TRIGGER</li> <li>• STOPPED</li> </ul>
	Acq. Mode	Available selections are SINGLE MODE or REPEAT MODE
<b>TRIGGER</b>	Trigger Modes	Available Trigger mode selections are: <ul style="list-style-type: none"> <li>• UPDATE PHASE CROSSING</li> <li>• OUTPUT ENABLE</li> <li>• OUTPUT DISABLE</li> <li>• FREQUENCY CHANGE</li> <li>• VOLTAGE RMS CHANGE</li> <li>• VOLTAGE DC CHANGE</li> <li>• PHASE CHANGE</li> <li>• WAVEFORM CHANGE</li> <li>• INTERHARMONIC CHANGE</li> </ul>
	Position	The trigger position can be set from 0% of vertical scale (left) to 100% of vertical scale (right). The trigger position is indicated using a yellow diamond on the time axis.
<b>TIME BASE</b>	Time/div	Available time base settings range from 10 sec/div to 20 µsec/div. The acquisition window is a function of this setting and the selected sample window size.
<b>OFFSET</b>	Trigger Offset	Trigger offset time and be set from 0 msec to 99,999,999,999,999,980,000 msec
<b>MEMORY DEPTH</b>	No of Samples	No samples acquires can be set from 100 Samples to 1M Samples
 		
<b>SAVE</b>	Image 	Saves Scope Image to PNG image file. Destination is browser default download directory. <b>Note:</b> Only the waveform display area of the browser window is saved. To save the entire screen, including all scope settings, use a screen capture utility instead.
	Data 	Saves scope data to CSV File. Destination is browser default download directory.

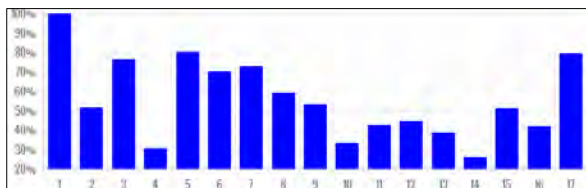
### 10.8.6 Harmonics

Harmonics measurements for voltage and current on all phases can be displayed using the Harmonics display screen as illustrated below. Both Bar Chart and Table displays are shown. The distortion values for the parameter selected (Voltage or Current) are display in a table directly below the Bar chart area.



Available selections in this measurement screen are:

CONTROL	Purpose
<b>SELECTED PHASE</b>	
<b>MEASUREMENT TYPE</b>	Selects Voltage L-N, Voltage L-L, Current or Both Voltage & Current
<b>FROM</b>	Selects the first harmonic number to display. Range is 1 ~ 49
<b>TO</b>	Selects the last harmonic number to display. Range is 2 ~ 50
<b>AUTO REFRESH</b>	Turns AUTO REFRESH mode ON or OFF
<b>REFRESH PERIOD</b>	Sets interval time for AUTO REFRESH mode in seconds. Range is 5 ~ 100.
<b>REFRESH</b>	Manual REFRESH button
<b>EXPORT GRAPH</b>	Downloads image for displayed Bar chart. See sample below.
<b>EXPORT DATA</b>	Downloads captured harmonics data in csv format text file. See sample below.



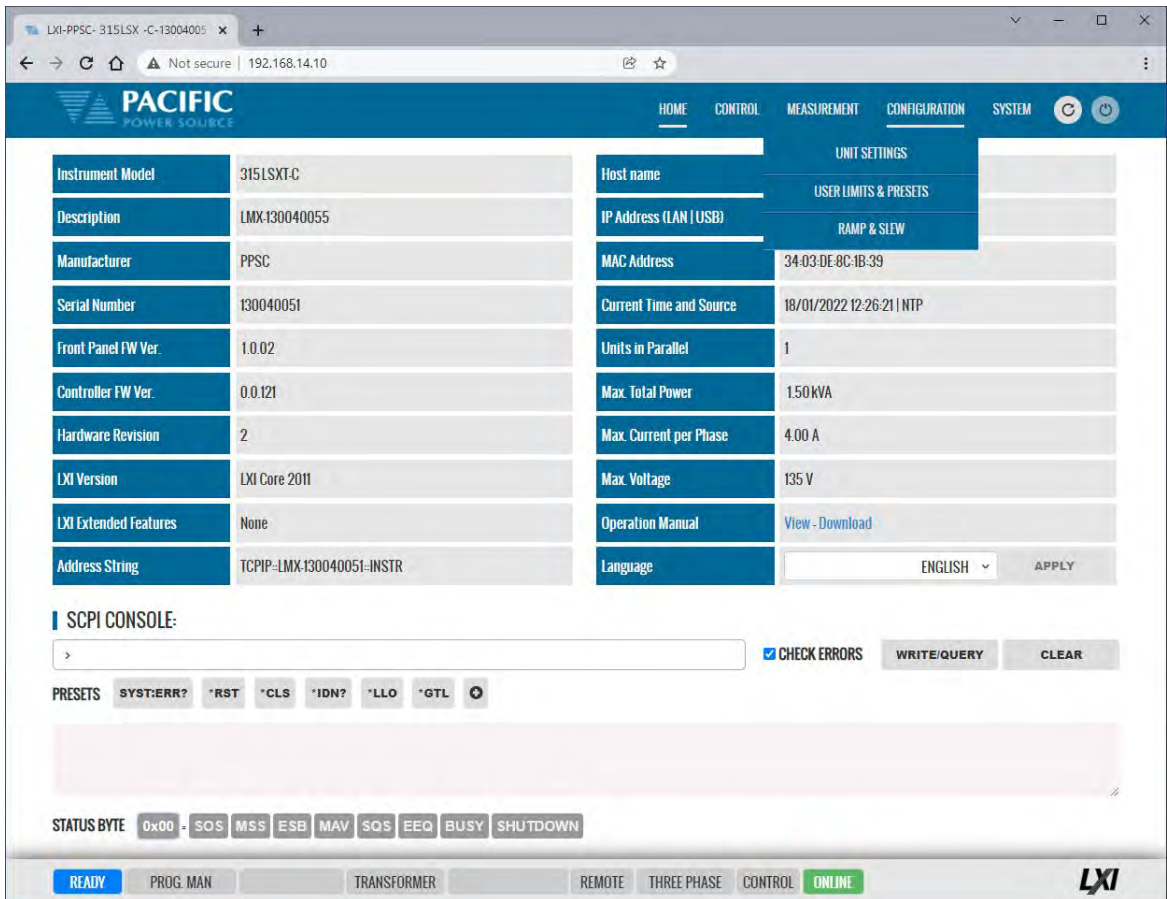
Measurement	Phase A[%]		
THD	455.98		
OHD	354.89		
EHD	286.32		
#	Freq.[Hz]	Phase A Mag.[%]	Phase A Phase.[Deg]
1	50	100	75.89
2	100	51.72	60.61
3	150	76.38	70.94
4	200	30.75	329.44
5	250	80.49	243.12
6	300	70.33	18.6
7	350	72.99	257.95
8	400	59.41	268.51

## 10.9 Configuration Screens

The CONFIGURATION menu provides access to secondary power source settings that are less frequently changed than those on the PROGRAM screen. Configuration screens available are:

- Unit Settings
- User Limits
- Ramp & Slew

Each is described in subsequent sections.



The screenshot displays the LXI configuration web interface. The browser address bar shows the URL 192.168.14.10. The interface has a blue header with the Pacific Power Source logo and navigation tabs: HOME, CONTROL, MEASUREMENT, CONFIGURATION (selected), and SYSTEM. A dropdown menu is open under CONFIGURATION, showing options for UNIT SETTINGS, USER LIMITS & PRESETS, and RAMP & SLEW.

Instrument Model	315LSXT-C	Host name	
Description	LMX130040055	IP Address (LAN   USB)	
Manufacturer	PPSC	MAC Address	34-03-DE-8C-1B-39
Serial Number	130040051	Current Time and Source	18/01/2022 12:26:21   NTP
Front Panel FW Ver.	1.0.02	Units in Parallel	1
Controller FW Ver.	0.0.121	Max. Total Power	1.50 KVA
Hardware Revision	2	Max. Current per Phase	4.00 A
LXI Version	LXI Core 2011	Max. Voltage	135 V
LXI Extended Features	None	Operation Manual	<a href="#">View - Download</a>
Address String	TCPIP::LMX130040051::INSTR	Language	ENGLISH <input type="button" value="APPLY"/>

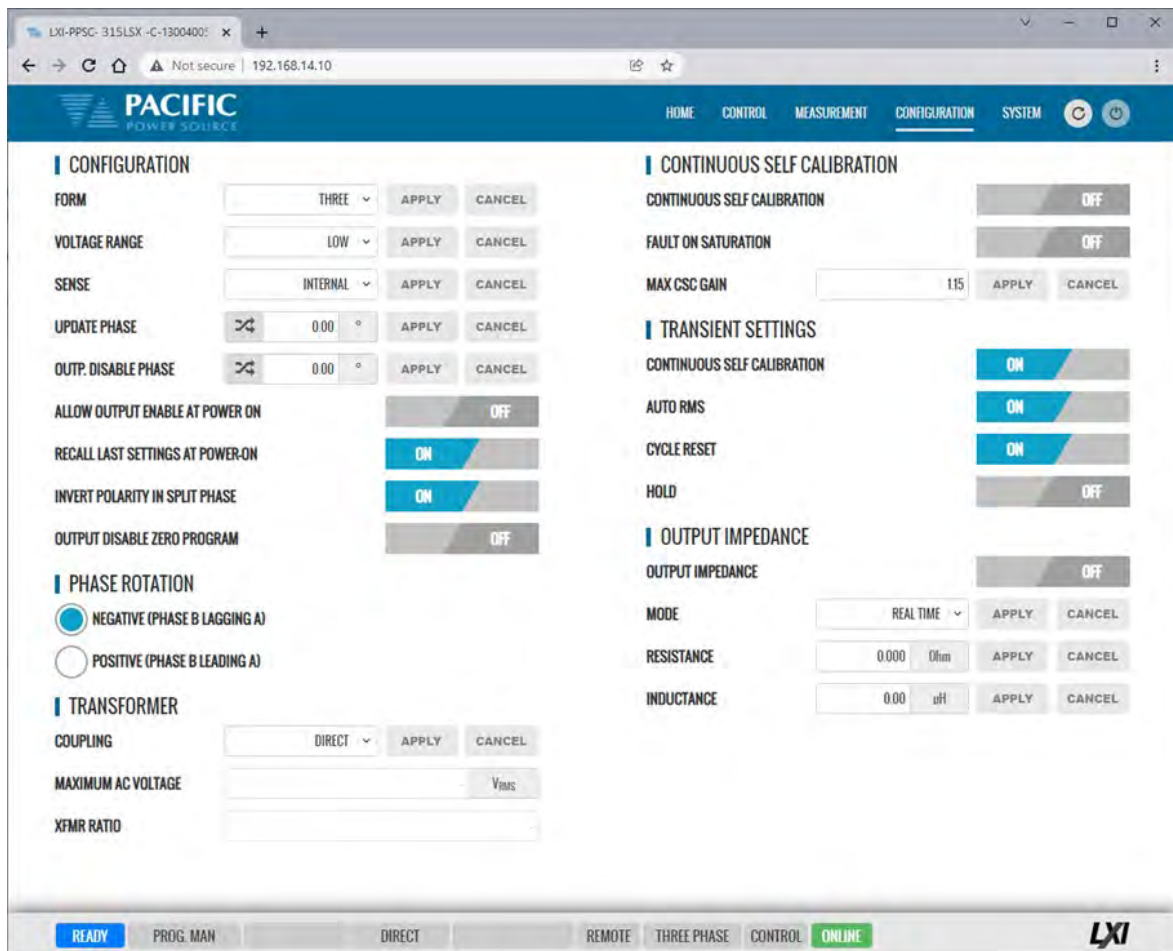
Below the settings table is the SCPI CONSOLE section, which includes a text input field, a  CHECK ERRORS checkbox, and buttons for WRITE/QUERY and CLEAR. There are also PRESETS buttons for SYST:ERR?, \*RST, \*CLS, \*IDN?, \*LLO, \*GTL, and a refresh icon. At the bottom, there is a STATUS BYTE section with buttons for 0x00, SOS, MSS, ESB, MAV, SOS, EEQ, BUSY, and SHUTDOWN. The bottom status bar shows: READY, PROG. MAN, TRANSFORMER, REMOTE, THREE PHASE, CONTROL, and ONLINE (highlighted in green). The LXI logo is in the bottom right corner.

### 10.9.1 Unit Settings

Unit settings determine the mode of operation of the power source. This includes phase mode, voltage range, output mode, update phase angle and ramp time for any output value changes made.

- Output enable at power on allows the unit to power up with the output enabled.
- The Enable Current Overload setting allows short duration overloads up to 30% over the normal continuous mode current limit set point.
- Phase Rotation selection changes output phasing between positive (leading) and negative (lagging) phase rotation in three phase output mode.
- The maximum adjustment limit for continuous self-calibration mode and fault generation on saturation can be set from this screen as well.
- The right-hand side of the screen contains Transient mode execution settings.
- Language selections are either ENGLISH or CHINESE.

These can all be set from the CONFIGURATION -> UNIT SETTINGS screen shown below.



The screenshot displays the web interface for the LXI-PPSC-315LSX-C-13004000 power source. The browser address bar shows the IP address 192.168.14.10. The interface is titled "PACIFIC POWER SOURCE" and includes navigation tabs for HOME, CONTROL, MEASUREMENT, CONFIGURATION (selected), and SYSTEM. The main content area is divided into several sections:

- CONFIGURATION:** Includes settings for FORM (THREE), VOLTAGE RANGE (LOW), SENSE (INTERNAL), UPDATE PHASE (0.00), and OUTP. DISABLE PHASE (0.00). Each setting has an "APPLY" and "CANCEL" button.
- PHASE ROTATION:** Features two radio button options: "NEGATIVE (PHASE B LAGGING A)" (selected) and "POSITIVE (PHASE B LEADING A)".
- TRANSFORMER:** Includes COUPLING (DIRECT), MAXIMUM AC VOLTAGE (V<sub>RMS</sub>), and XFMR RATIO.
- CONTINUOUS SELF CALIBRATION:** Includes CONTINUOUS SELF CALIBRATION (OFF), FAULT ON SATURATION (OFF), and MAX CSC GAIN (115).
- TRANSIENT SETTINGS:** Includes CONTINUOUS SELF CALIBRATION (ON), AUTO RMS (ON), CYCLE RESET (ON), and HOLD (OFF).
- OUTPUT IMPEDANCE:** Includes OUTPUT IMPEDANCE (OFF), MODE (REAL TIME), RESISTANCE (0.000 Ohm), and INDUCTANCE (0.00 uH).

At the bottom of the interface, there is a status bar with buttons for READY, PROG. MAN, DIRECT, REMOTE, THREE PHASE, CONTROL, and ONLINE (highlighted in green). The LXI logo is visible in the bottom right corner.



### 10.9.2 User Limits & Presets

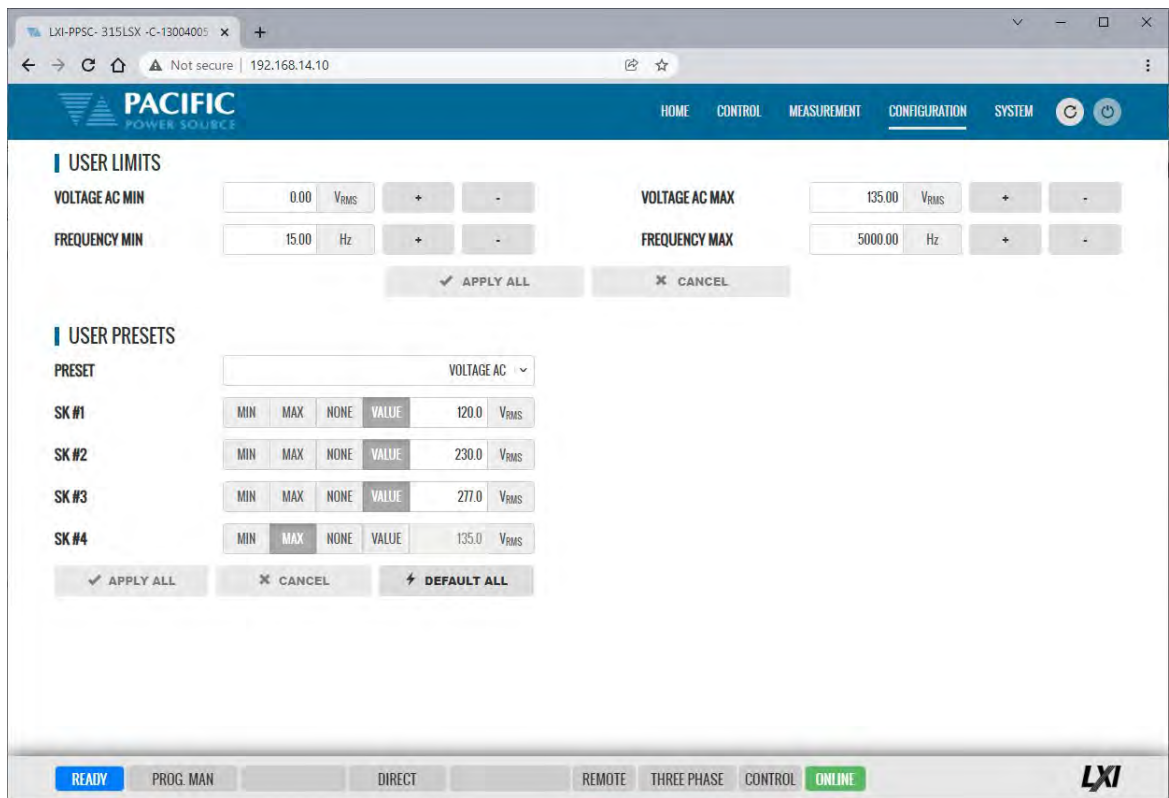
User limits can be used to minimize operator error by setting upper and/or lower limits on programmable parameter ranges.

Limits can be set for Voltage AC, Voltage DC and Frequency.

**Note:** When changing user limits, make sure programmed parameter settings in effect are not outside the new upper and lower limits entered.

All user limits can be set from the CONFIGURATION -> USER LIMITS& PRESETS screen shown below.

Extended range for voltage and frequency may be selected as needed. Some restrictions apply when operating in extended range mode.

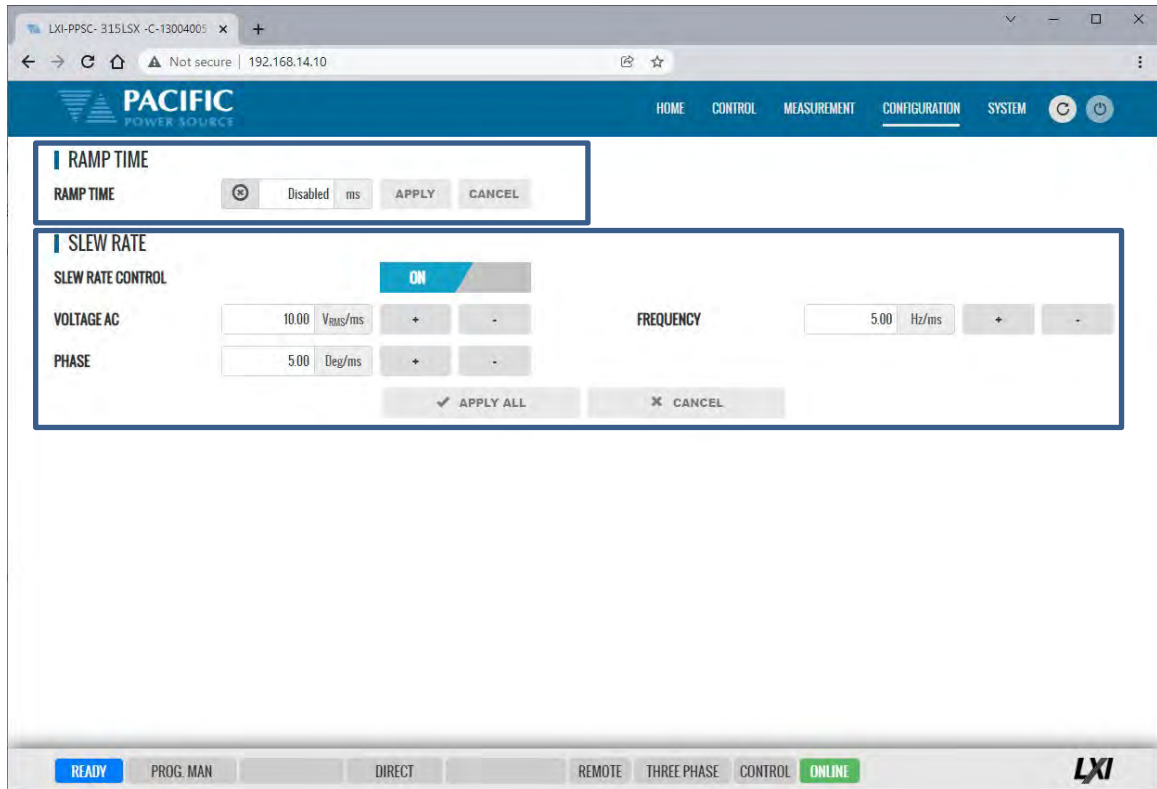


User programmable presets can be set to define the set values of the Soft keys in the program screens. This allows commonly used setting values to be selected by an operator by just pressing a single soft key. See image above for samples.

### 10.9.3 Ramp Time & Slew Rate

The Slew Rate screen has entries for all available programmable slew rate settings. This includes Voltage AC and Frequency. Note that both are mutually exclusive as they would conflict with each other. To use programmable slew rates, the RAMP TIME must be disabled.

Slew Rates can be set for Voltage AC and Frequency.

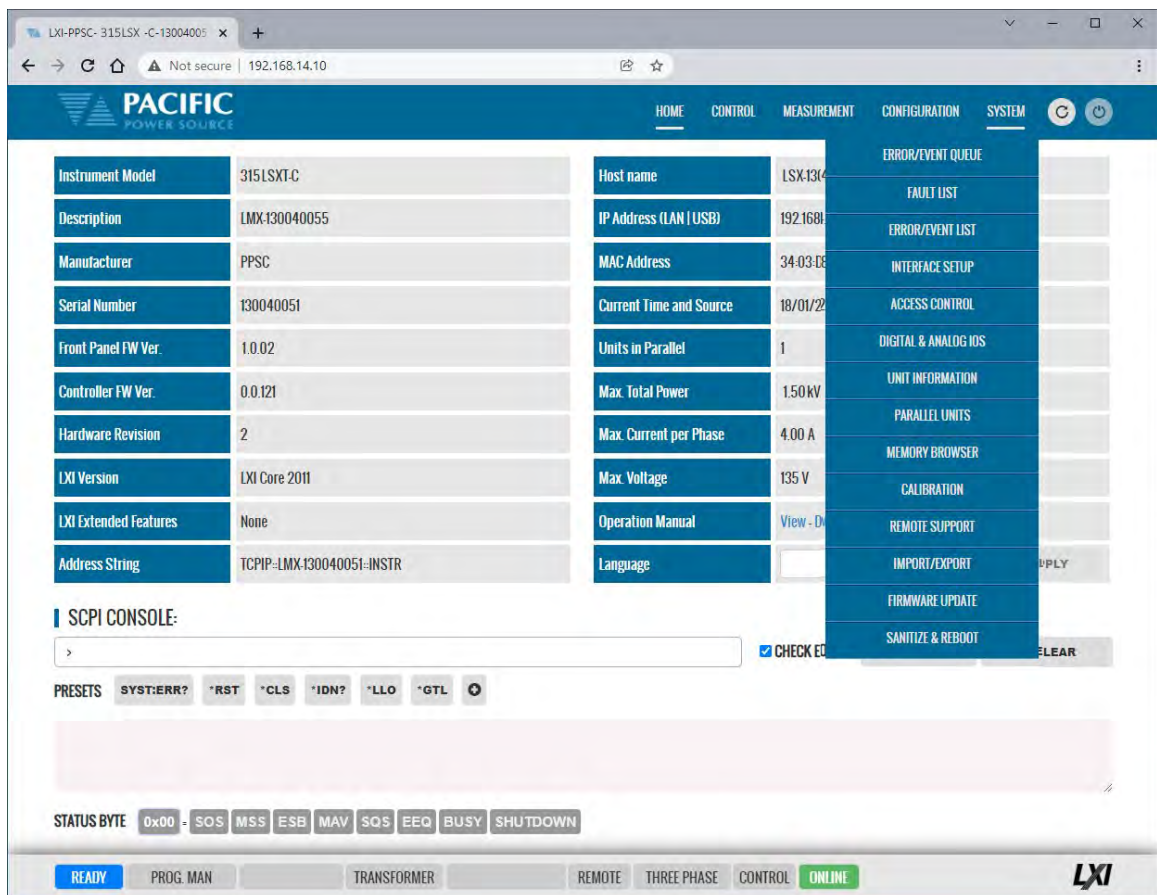


## 10.10 System Screens

The SYSTEM menu provides access to system level settings. System setting screens available are:

- ERROR/EVENT QUEUE
- FAULT LIST
- ERROR/EVENT LIST
- INTERFACE SETUP
- ACCESS CONTROL
- DIGITAL & ANALOG IOS
- UNIT INFORMATION
- PARALLEL UNITS
- MEMORY BROWSER
- CALIBRATION
- REMOTE SUPPORT
- IMPORT/EXPORT
- FIRMWARE UPDATE
- SANITIZE & REBOOT

Each is described in subsequent sections.



The screenshot displays the LXI-PPSC web interface. At the top, there is a navigation bar with tabs for HOME, CONTROL, MEASUREMENT, CONFIGURATION, and SYSTEM. The SYSTEM tab is active, and a dropdown menu is open, listing the following options: ERROR/EVENT QUEUE, FAULT LIST, ERROR/EVENT LIST, INTERFACE SETUP, ACCESS CONTROL, DIGITAL & ANALOG IOS, UNIT INFORMATION, PARALLEL UNITS, MEMORY BROWSER, CALIBRATION, REMOTE SUPPORT, IMPORT/EXPORT, FIRMWARE UPDATE, and SANITIZE & REBOOT. The main content area shows system information for instrument model 315LSXT-C, including description, manufacturer, serial number, and various power and configuration parameters.

Instrument Model	315LSXT-C	Host name	LSX-130040051
Description	LMX-130040055	IP Address (LAN   USB)	192.168.14.10
Manufacturer	PPSC	MAC Address	34-03-D3-00-00-00
Serial Number	130040051	Current Time and Source	18/01/2023 10:00:00
Front Panel FW Ver.	1.0.02	Units in Parallel	1
Controller FW Ver.	0.0.121	Max. Total Power	1.50 kW
Hardware Revision	2	Max. Current per Phase	4.00 A
LXI Version	LXI Core 2011	Max. Voltage	135 V
LXI Extended Features	None	Operation Manual	View - Download
Address String	TCPIP-130040051-INSTR	Language	English

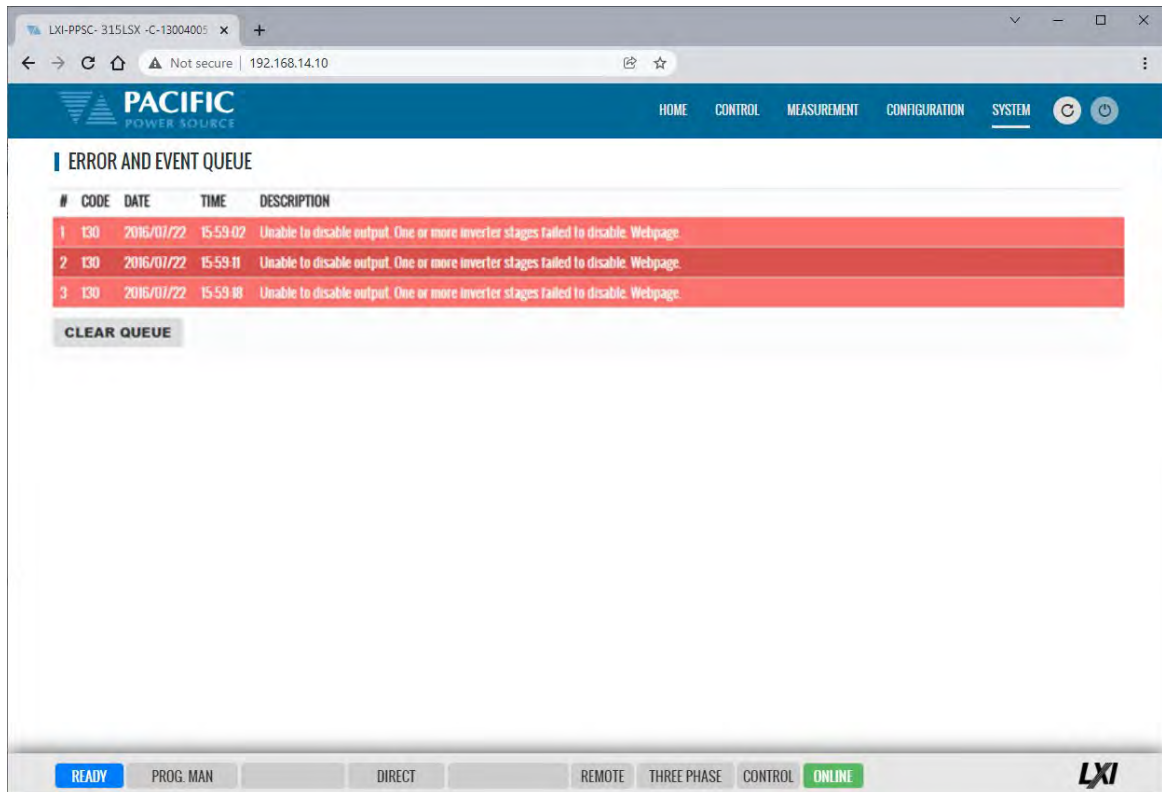
Below the system information, there is an SCPI CONSOLE section with a text input field and a CHECK ERROR button. At the bottom, there is a STATUS BYTE section with various indicators: 0x00, SOS, MSS, ESB, MAV, SQS, EEQ, BUSY, SHUTDOWN. The bottom navigation bar shows the current status as ONLINE.

### 10.10.1 Error/Event Queue

The Error and Event Queue tracks internal errors or communication errors that may occur during normal user. Generally, such errors are the results of programming conflicts or setting conflicts and are no cause for concern. Other events may be normal, such as a power-on event and will be recorded in the same queue. The user can clear the queue at any time using the

**CLEAR QUEUE** button.

Actual hardware faults are tracked in the FAULT queue. See next section.



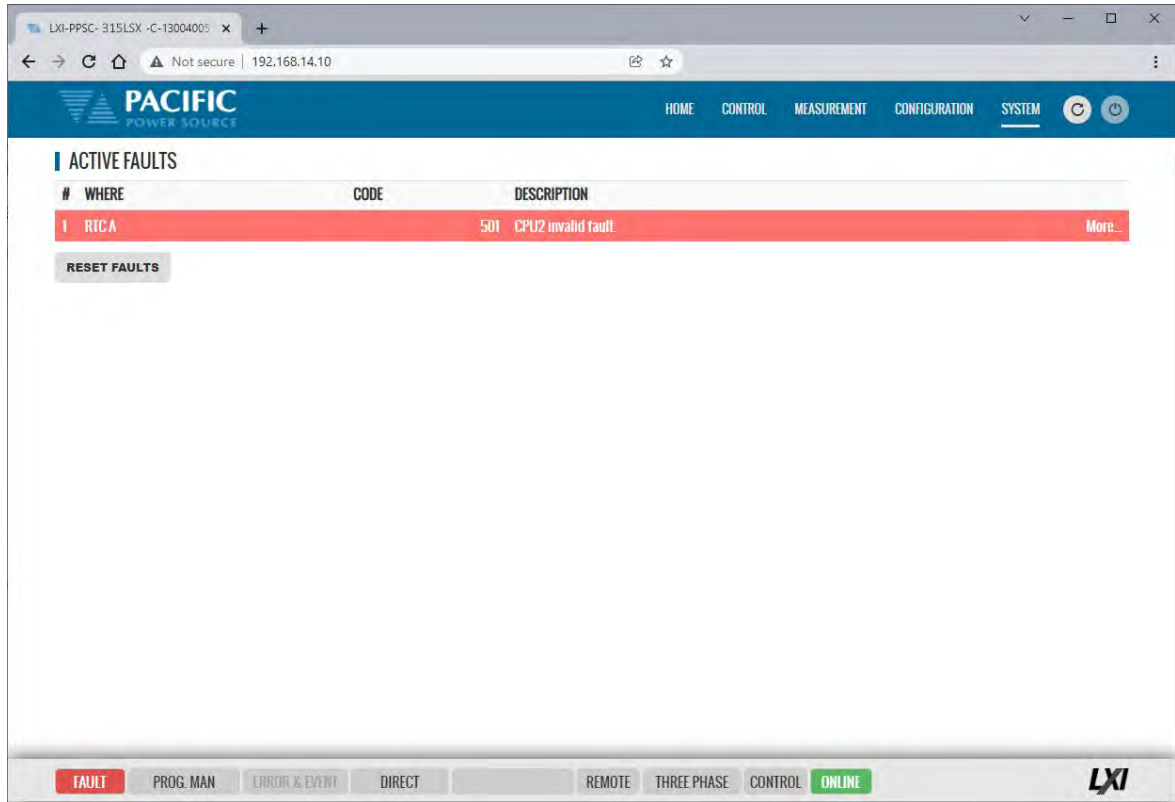
The screenshot shows a web browser window with the URL 192.168.14.10. The page title is "LXI-PPSC-315LSX -C-13004005". The navigation menu includes HOME, CONTROL, MEASUREMENT, CONFIGURATION, and SYSTEM. The main content area is titled "ERROR AND EVENT QUEUE" and contains a table with the following data:

#	CODE	DATE	TIME	DESCRIPTION
1	130	2016/07/22	15:59:02	Unable to disable output. One or more inverter stages failed to disable. Webpage.
2	130	2016/07/22	15:59:11	Unable to disable output. One or more inverter stages failed to disable. Webpage.
3	130	2016/07/22	15:59:18	Unable to disable output. One or more inverter stages failed to disable. Webpage.

Below the table is a "CLEAR QUEUE" button. At the bottom of the interface, there are status indicators: READY, PROG. MAN, DIRECT, REMOTE, THREE PHASE, CONTROL, and ONLINE (highlighted in green). The LXI logo is in the bottom right corner.



### 10.10.2 Fault List

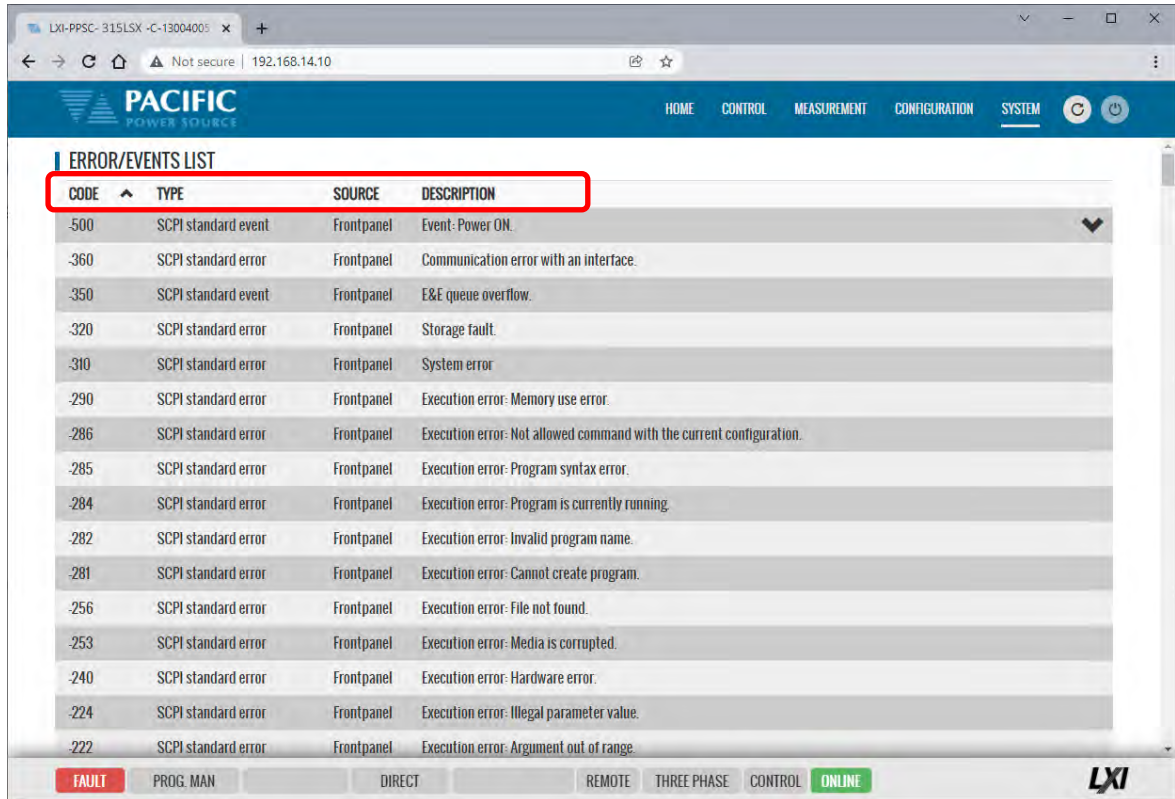
The Fault List tracks hardware faults that may occur in the power conversion stages. This information may be useful for PPS engineering staff.





### 10.10.3 Error/Event List

The Error Event list provides a complete listing of all possible error and event messages. The description may include possible troubleshooting hints to resolve any error conditions.

This Error list can be sorted by clicking on any of the headings. By error code, type, source or description. Clicking again on the same heading reverses the sort order. The selected sort is indicated by an up  or down  arrow.



CODE 	TYPE	SOURCE	DESCRIPTION
-500	SCPI standard event	Frontpanel	Event: Power ON. 
-360	SCPI standard error	Frontpanel	Communication error with an interface.
-350	SCPI standard event	Frontpanel	E&E queue overflow.
-320	SCPI standard error	Frontpanel	Storage fault.
-310	SCPI standard error	Frontpanel	System error
-290	SCPI standard error	Frontpanel	Execution error: Memory use error.
-286	SCPI standard error	Frontpanel	Execution error: Not allowed command with the current configuration.
-285	SCPI standard error	Frontpanel	Execution error: Program syntax error.
-284	SCPI standard error	Frontpanel	Execution error: Program is currently running.
-282	SCPI standard error	Frontpanel	Execution error: Invalid program name.
-281	SCPI standard error	Frontpanel	Execution error: Cannot create program.
-256	SCPI standard error	Frontpanel	Execution error: File not found.
-253	SCPI standard error	Frontpanel	Execution error: Media is corrupted.
-240	SCPI standard error	Frontpanel	Execution error: Hardware error.
-224	SCPI standard error	Frontpanel	Execution error: Illegal parameter value.
-222	SCPI standard error	Frontpanel	Execution error: Argument out of range.

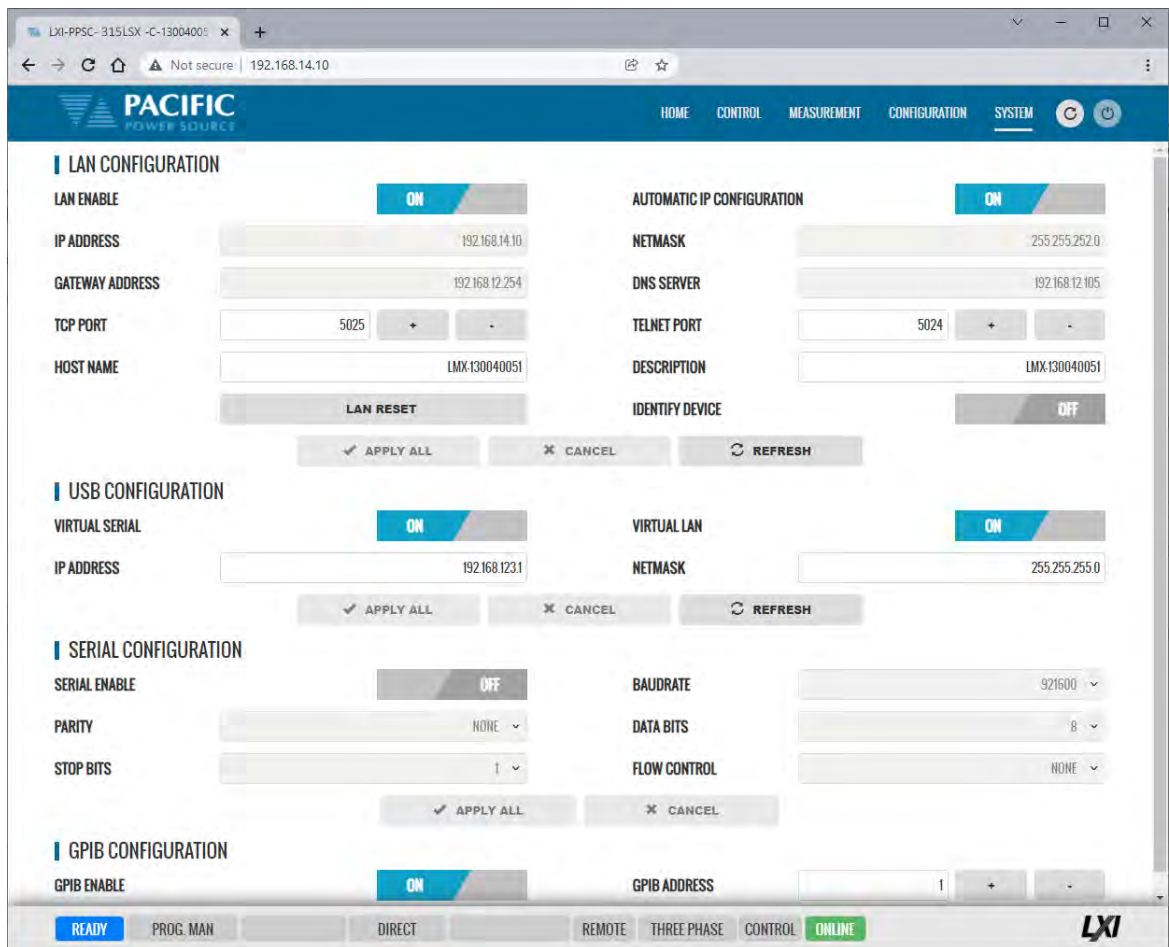
At the bottom of the interface, there are status buttons: **FAULT** (red), PROG. MAN, DIRECT, REMOTE, THREE PHASE, CONTROL, and **ONLINE** (green). The LXI logo is in the bottom right corner.

### 10.10.4 Interface Setup

The Interface setup screen allows enabling or disabling of several available interfaces and operating modes. The interfaces are arranged by type:

- LAN
- USB
- RS232 Serial
- GPIB

Interfaces that are not used can be turned off to avoid conflicts caused by multiple active interfaces at the user's discretion.



The screenshot displays the LAN Configuration web interface. The browser address bar shows '192.168.14.10'. The interface is divided into four main sections:

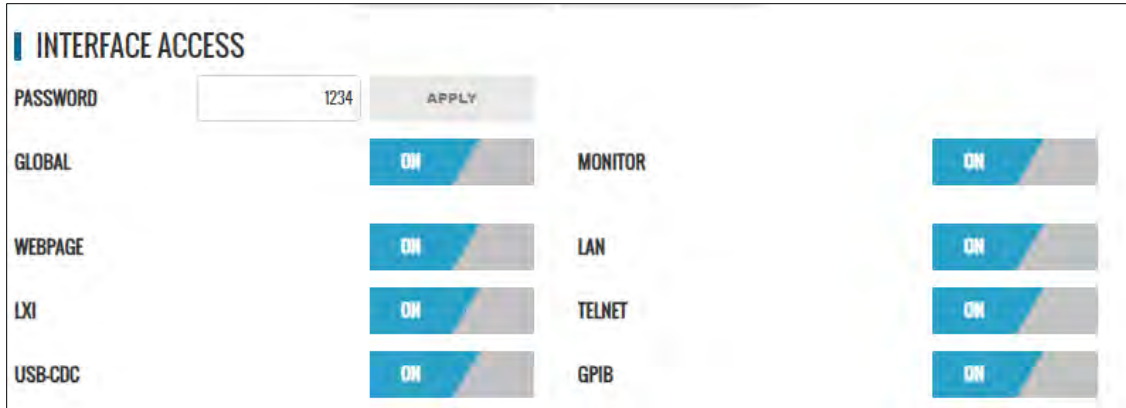
- LAN CONFIGURATION:** Includes 'LAN ENABLE' (ON), 'IP ADDRESS' (192.168.14.10), 'GATEWAY ADDRESS' (192.168.12.254), 'TCP PORT' (5025), 'HOST NAME' (LMX130040051), 'AUTOMATIC IP CONFIGURATION' (ON), 'NETMASK' (255.255.252.0), 'DNS SERVER' (192.168.12.105), 'TELNET PORT' (5024), 'DESCRIPTION' (LMX130040051), and 'IDENTIFY DEVICE' (OFF). Buttons include 'LAN RESET', 'APPLY ALL', 'CANCEL', and 'REFRESH'.
- USB CONFIGURATION:** Includes 'VIRTUAL SERIAL' (ON) and 'VIRTUAL LAN' (ON). 'IP ADDRESS' is 192.168.123.1 and 'NETMASK' is 255.255.255.0. Buttons include 'APPLY ALL', 'CANCEL', and 'REFRESH'.
- SERIAL CONFIGURATION:** Includes 'SERIAL ENABLE' (OFF), 'PARITY' (NONE), 'STOP BITS' (1), 'BAUDRATE' (921600), 'DATA BITS' (8), and 'FLOW CONTROL' (NONE). Buttons include 'APPLY ALL' and 'CANCEL'.
- GPIB CONFIGURATION:** Includes 'GPIB ENABLE' (ON) and 'GPIB ADDRESS' (1). Buttons include 'APPLY ALL' and 'CANCEL'.

At the bottom, a status bar shows 'READY', 'PROG. MAN', 'DIRECT', 'REMOTE', 'THREE PHASE', 'CONTROL', and 'ONLINE' (highlighted in green). The LXI logo is in the bottom right corner.

### 10.10.5 Access Control

The LSX supports a network-based sharing feature. Two protocols. These can be enabled from the Sharing Options screen.

The access control screen also allows restricting access to the power source over the LAN interface. This is an important requirement for power sources connected to a companywide Ethernet network. Without access restrictions, persons not present where the power source is located could inadvertently cause a dangerous condition by either enabling the OUTPUT or changing programmed settings.



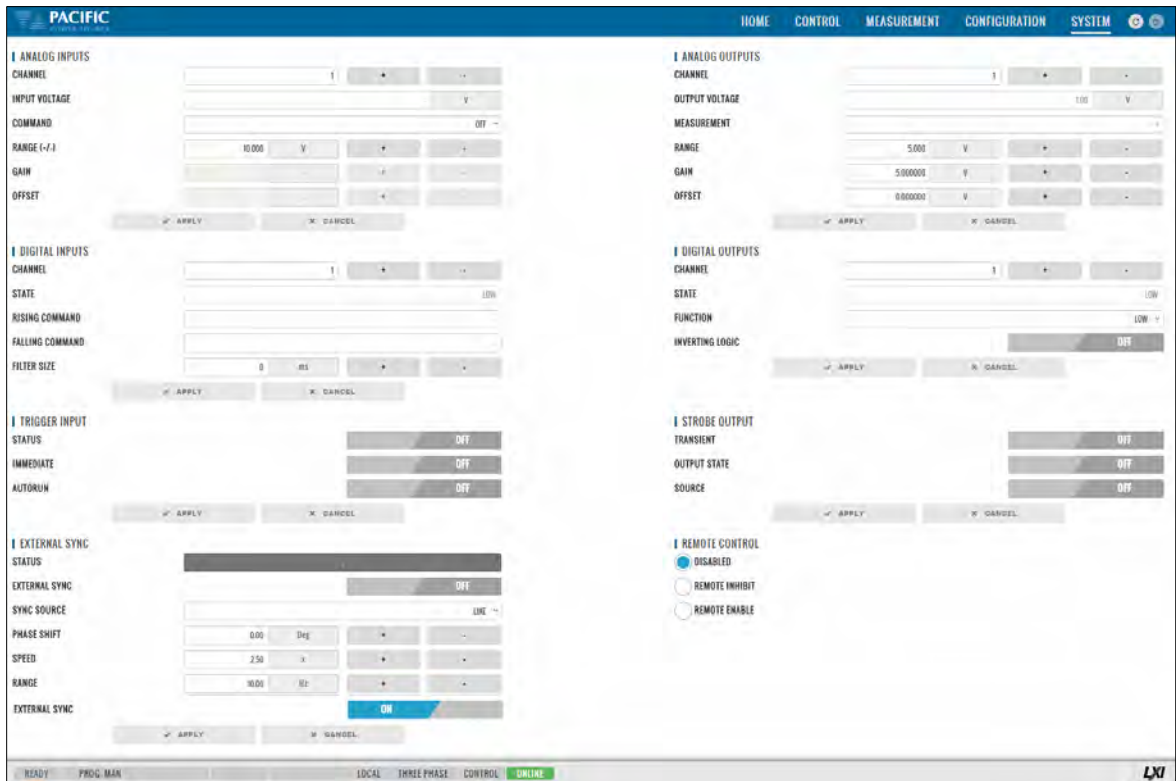
Access control can limit access from specific IP addresses only and requires someone physically present where the power source is to grant access to anyone else.

For more details, refer to section 10.3, “Access Control” on page 403 of this manual.



### 10.10.6 Digital & Analog IO's




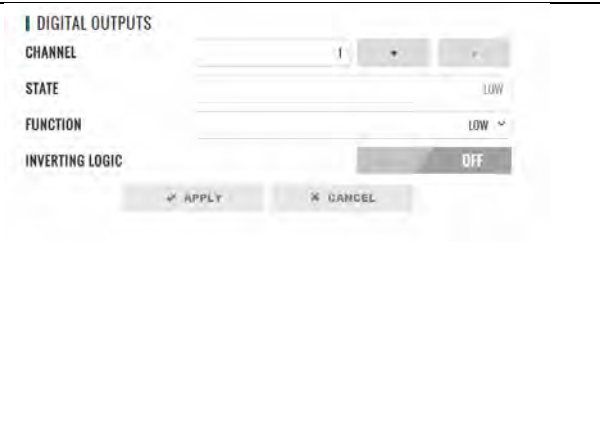
The Digital and Analog IO screen allows configuration of the available Auxiliary I/O functions. Note that this feature is not available on LSX-2L and LSX-4L models.



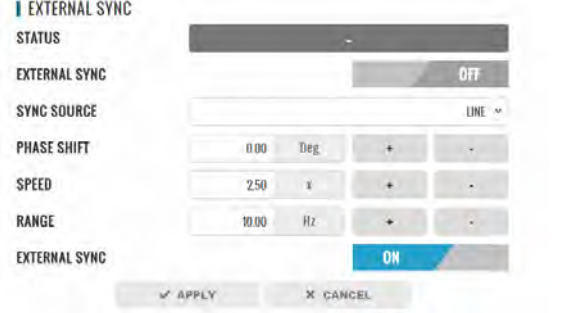
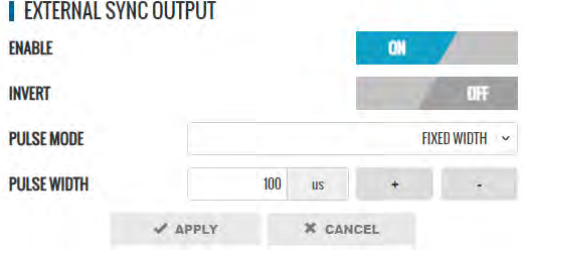



There are eight groups of functions that are available to be configured with the selectable settings listed in the table below.

#### 10.10.6.1 Function Groups

There are eight groups of functions that are available to be configured with the selectable settings listed in the table below.

Grouping	Controls
<p><b>Analog Inputs:</b></p> <p>CHANNEL [ 1   2   3   4 ]</p> <p>INPUT VOLTAGE Displays read back voltage</p> <p>COMMAND Select command from dropdown list or OFF for none</p> <p>RANGE 0.0000 – 10.000 V</p> <p>GAIN Gain</p> <p>OFFSET Offset value</p>	
<p><b>Analog Outputs:</b></p> <p>CHANNEL [ 1   2   3   4 ]</p> <p>OUTPUT VOLTAGE Output setting</p> <p>MEASUREMENT Select measurement to be assigned to output</p> <p>RANGE 0.0000 – 5.000 V</p> <p>GAIN Gain 0.000 - 1000</p> <p>OFFSET Offset value – 1000 ~+1000</p>	
<p><b>Digital Inputs:</b></p> <p>CHANNEL [ 1   2   3 ]</p> <p>STATE Displays input state</p> <p>RISING CMD Set command string to execute on rising edge</p> <p>FALLING CMD Set command string to execute on falling edge</p> <p>FILTER SIZE 0 – 10,000,000 msec</p>	
<p><b>Digital Outputs:</b></p> <p>CHANNEL [ 1   2   3   4 ]</p> <p>STATE Displays current state</p> <p>FUNCTION Assigns state to selected channel. Available states are: FAULT FORM HIGH LOW OUTPUT STATE PROGRAM REMOTE TRANSIENT</p> <p>INV. LOGIC [ ON   OFF ] Reverses polarity</p>	

Grouping	Controls
<p><b>Trigger Input:</b></p> <p>STATUS [ ON   OFF ] Enabled or disabled</p> <p>IMMEDIATE [ ON   OFF ] Ignore phase update setting if ON</p> <p>AUTORUN [ ON   OFF ] No RUN command required if ON</p>	
<p><b>Strobe Output:</b></p> <p>TRANSIENT ON = Strobe output on transient start</p> <p>OUTPUT STATE ON = Strobe output on relay close</p> <p>SOURCE ON = Strobe output on any program parameter change</p>	
<p><b>External Sync:</b></p> <p>STATUS Display SYNC Status</p> <p>EXTERNAL SYNC [ ON   OFF ]</p> <p>SYNC SOURCE Select Sync source</p> <p>Available sources are: - External sync input on I/O connector - LINE (AC input to power source)</p> <p>PHASE SHIFT Offset Phase A angle</p> <p>SPEED 1.00 ~ 10.00</p> <p>RANGE 0.10 ~ 1200 Hz</p> <p>EXTERNAL SYNC [ ON   OFF ]</p>	
<p><b>External Sync Output:</b></p> <p>ENABLE [ ON   OFF ]</p> <p>INVERT [ ON   OFF ]</p> <p>PULSE MODE Fixed Width Duty Cycle 50%</p> <p>Pulse Width 3 ~ 100000 msec</p>	
<p><b>Remote Controls:</b></p> <p>DISABLED No remote output control</p> <p>REMOTE INHIBIT Contact closure needed to close output relay</p> <p>REMOTE ENABLE Contact closure or front panel can control output relay</p> <p>See section 5.14.2</p>	

10.10.6.2 On-line Analog and Digital I/O help screens.

To aid in configuring and using the many I/O capabilities of the power source, a series of on-line help screens containing formulas and graphs for digital and analog I/Os settings are provided.

Some screens are shown below for reference.

**ANALOG OUTPUTS**

The output voltage will be automatically set with a VALUE given by this formula:

$$VALUE = \frac{MEASUREMENT - OFFSET + CO * GAIN}{GAIN * CG} * RANGE$$

- CG is the calibration gain. By default, it is 1 and it can be set with SYSTEM:AIO-Output#-CALibration-GAIN
- CO is the calibration offset. By default, it is 0 and it can be set with SYSTEM:AIO-Output#-CALibration-Offset

The GAIN and OFFSET change when the measurement is changed while the CO and CG do not change.

With CO equal to 0 and CG equal to 1, the formula is:

$$VALUE = \frac{MEASUREMENT - OFFSET}{GAIN} * RANGE$$

**ANALOG INPUTS**

The selected COMMAND will be automatically set with a VALUE given by this formula:

$$VALUE = \left( \frac{INPUT VOLTAGE}{RANGE} * CG - CO \right) * GAIN + OFFSET$$

- CG is the calibration gain. By default, it is 1 and it can be set with SYSTEM:AIO-Input#-CALibration-GAIN
- CO is the calibration offset. By default, it is 0 and it can be set with SYSTEM:AIO-Input#-CALibration-Offset

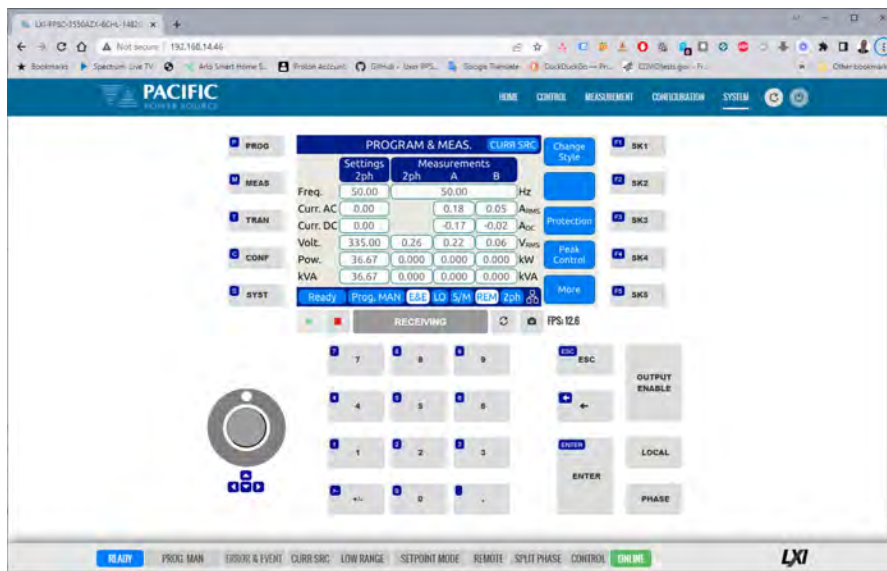
The GAIN and OFFSET change when the COMMAND is changed while the CO and CG do not change.

With CO equal to 0 and CG equal to 1, the formula is:

$$VALUE = \left( \frac{INPUT VOLTAGE}{RANGE} \right) * GAIN + OFFSET$$

### 10.10.7 Remote Interface (Virtual Front Panel)





The Remote Interface browser screen provides a virtual front panel that allows controlling the power source from a remote location using a PC, tablet or smart phone. The screen layout is a function of the web hosting device screen width. If wide enough, the layout will match that of the actual front panel of the power source. If too narrow for a landscape view, the front panel will be divided between the LCD screen, function and soft keys on top and the know plug decimal keypad and other control beneath it. Both layouts are shown below.



The operation of this Virtual Front panel is identical of that of the physical front panel so refer to Section 6, “Front Panel Operation” on page 95 for user information. The controls located directly below the virtual LCD screen may be used when the internet connection used is slow or there is too much latency.




Available controls are:

-  Enable continuous update mode. In this mode, the status bar will show .
-  Stop continuous updated mode. The connection status will show .

**RECEIVING** Status Bar shows state of connection to the power source. Clicking on it will toggle connections status between **DISCONNECTED** and **CONNECTED**.

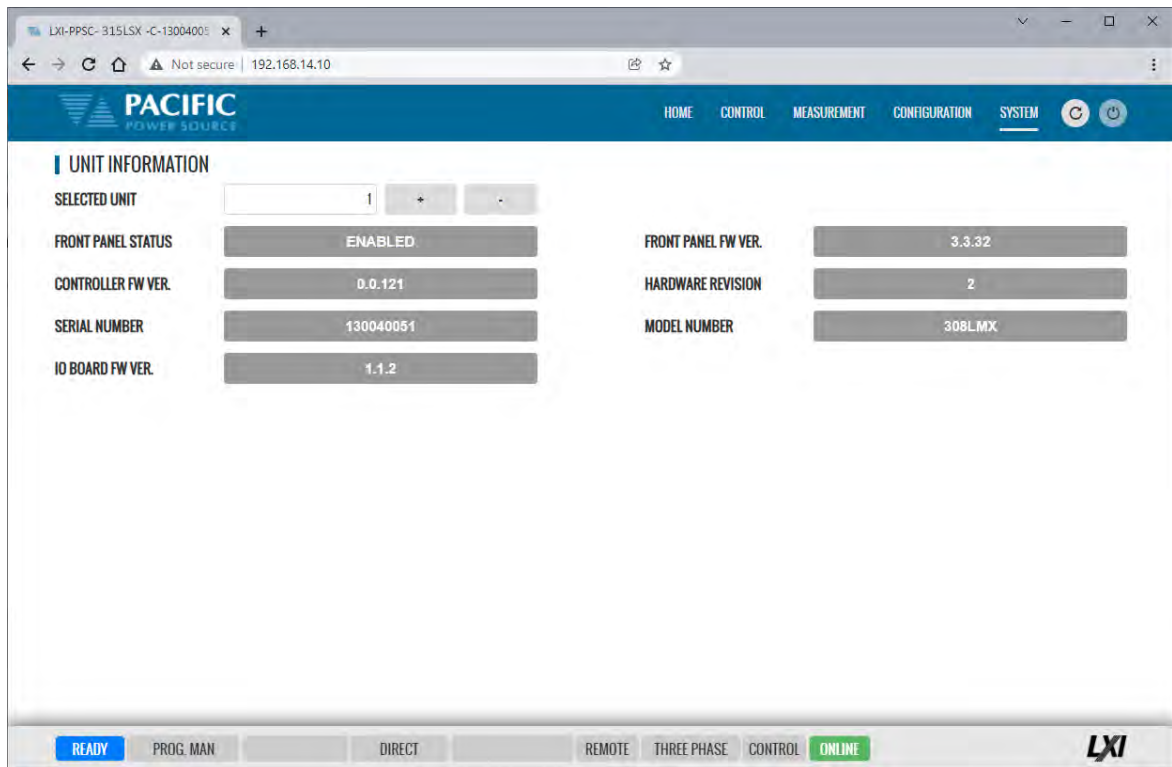
 Refresh button may be used when continuous updates are off to refresh the display

 Click to download a .png image of the virtual LCD display.

The status field to the right of the control buttons display the measurement frame update rate. In the example shown here the frame rate is 14.6 frames per second.

### 10.10.8 Unit Information

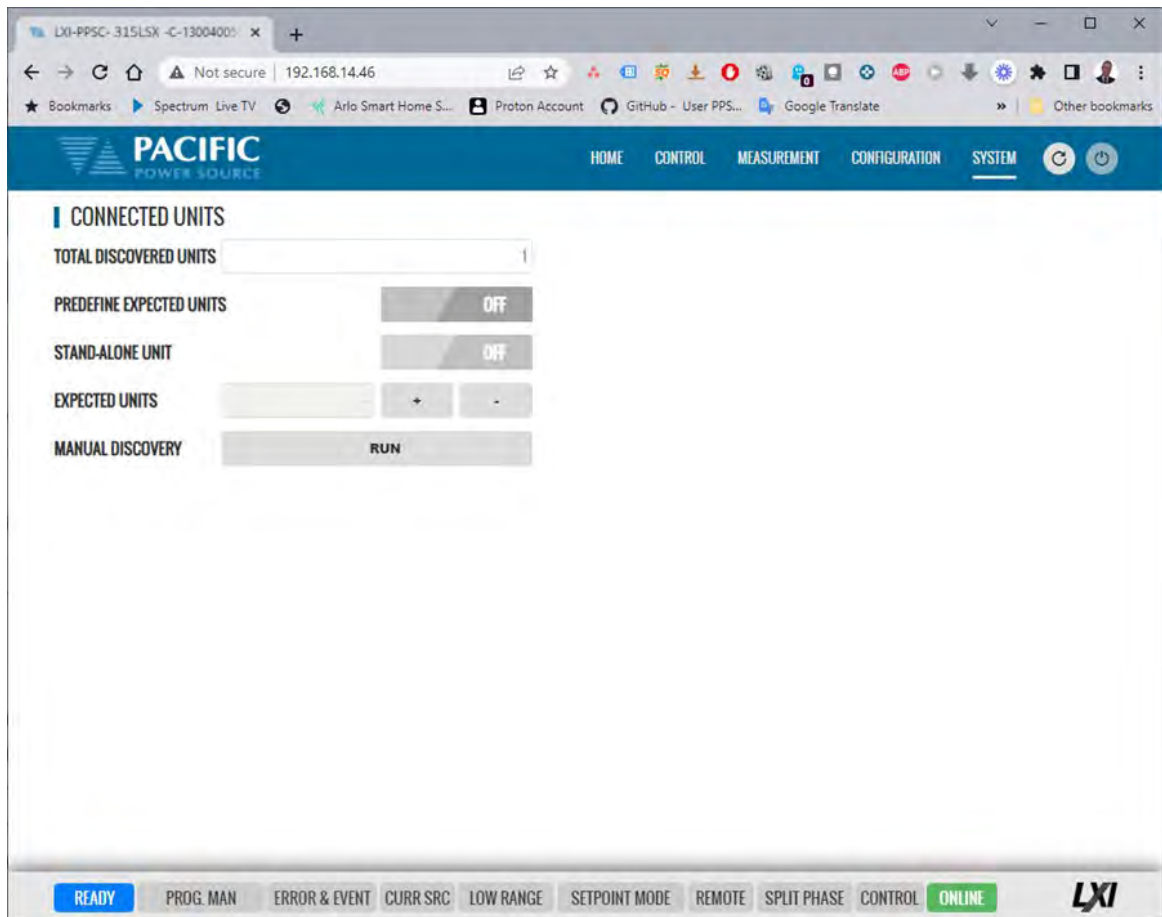
The Unit Information screen contains some of the same information as is found on the HOME screen but it can be used to query this information from one or more auxiliary unit as well in a parallel system. The HOME screen will only display information for the Master unit of a parallel configured system. Use the SELECTED UNIT control to select units downstream from the master (1).



### 10.10.9 Connected Units

The Connected Units screen displays the number of powered on units connected in either a Parallel or Series system. It also allows the expected number of units to be set so the master can determine if all connected units are indeed turned on before starting operation. **(Paralleling of LSX model units is NOT supported.)**

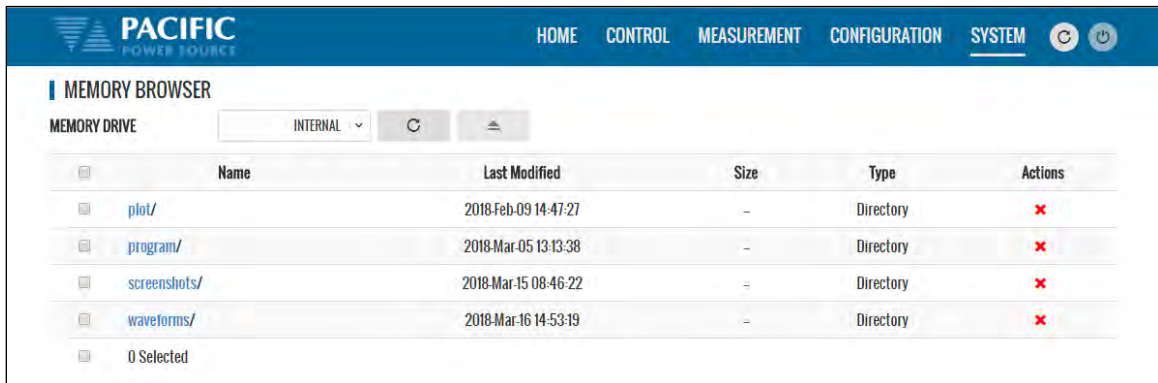
The MANUAL DISCOVERY can be run to refresh the parallel confirmation if a unit has been turned on or off without power cycling the master.



### 10.10.10 Memory Browser

The Memory Browser screen shows available memory devices connected to the instrument including internal memory and available directories and files. All data and setup files are in XML format. Waveform files are stored in CSV format. Screen captures are stored in PNG image format.

Available MEMORY DRIVES are INTERNAL, RAM and any USB or SD-Card memory devices that are mounted.



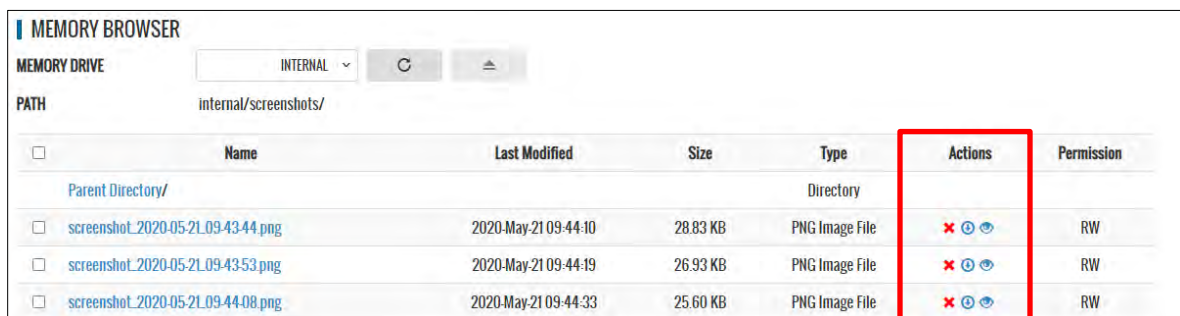
Useful directories for the user are:

DIRECTOR	FILES IN THIS DIRECTORY
plot/	Data logger plots in csv file format with date and time stamp
program/	Power source program settings
screenshots/	Screen capture image files in .png format with date and time stamp. To capture any LCD display, press the LOCAL key and the number 1 key on the decimal keypad at the same time.
waveforms/	User waveform data points in csv file format.

#### 10.10.10.1 Screenshots

Screenshots of the LDC display saved by pressing the LOCAL + 1 key simultaneously are saved in the screenshots subdirectory. The controls in the Actions column allow the user to:

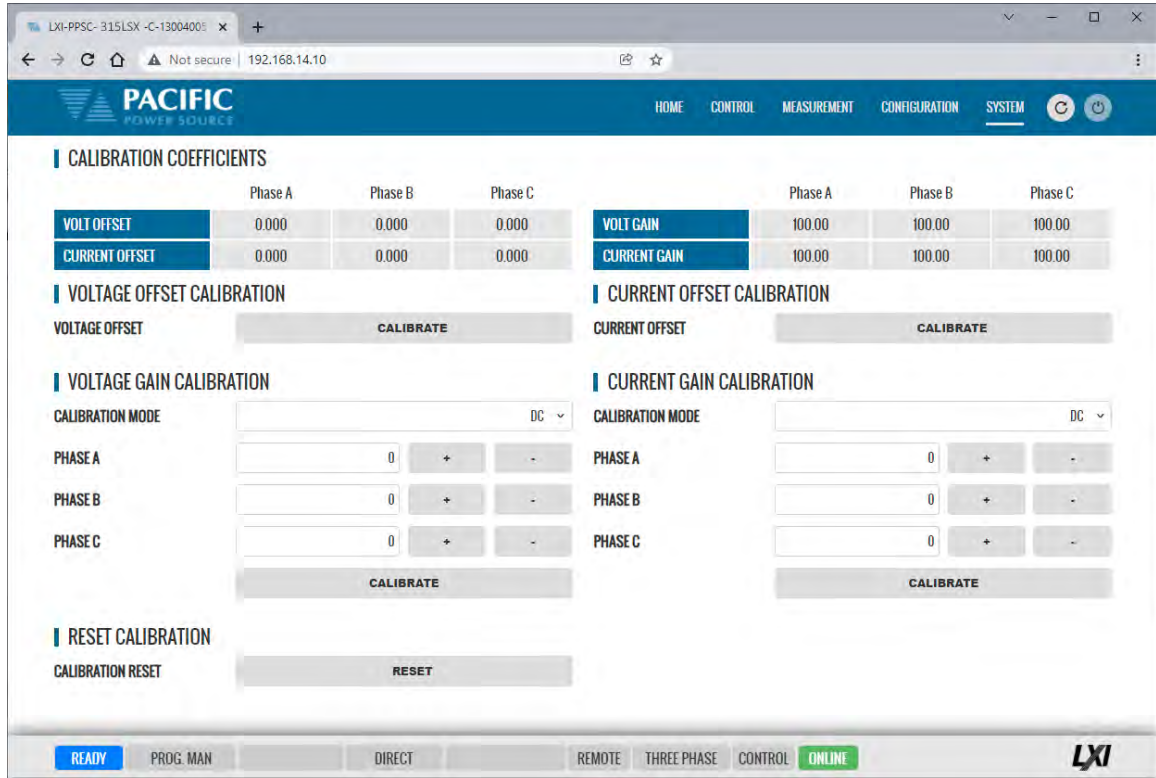
- Delete
- Download
- Preview





### 10.10.11 Calibration

The Calibration screen shows all user accessible calibration coefficients. It also allows for user calibration of voltage and current to be performed. The Web Browser user interface is specific but the procedures and equipment are the same as calibration from the front panel. Refer to Section 11.4, “Calibration Procedures” for details.



**CALIBRATION COEFFICIENTS**

	Phase A	Phase B	Phase C		Phase A	Phase B	Phase C
<b>VOLT OFFSET</b>	0.000	0.000	0.000	<b>VOLT GAIN</b>	100.00	100.00	100.00
<b>CURRENT OFFSET</b>	0.000	0.000	0.000	<b>CURRENT GAIN</b>	100.00	100.00	100.00

**VOLTAGE OFFSET CALIBRATION**  
VOLTAGE OFFSET  **CALIBRATE**

**VOLTAGE GAIN CALIBRATION**  
CALIBRATION MODE:  DC  
 PHASE A:  0    
 PHASE B:  0    
 PHASE C:  0    
**CALIBRATE**

**CURRENT OFFSET CALIBRATION**  
CURRENT OFFSET  **CALIBRATE**

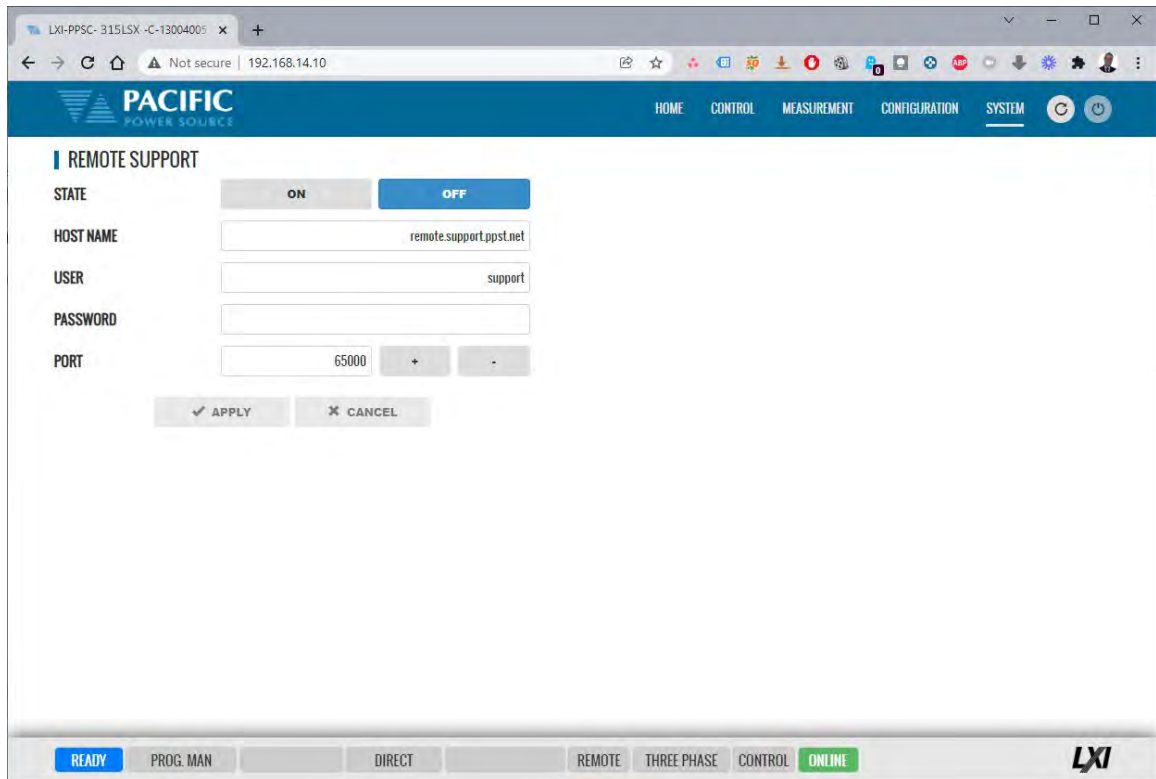
**CURRENT GAIN CALIBRATION**  
CALIBRATION MODE:  DC  
 PHASE A:  0    
 PHASE B:  0    
 PHASE C:  0    
**CALIBRATE**

**RESET CALIBRATION**  
CALIBRATION RESET

READY PROG. MAN DIRECT REMOTE THREE PHASE CONTROL **ONLINE** LXI

### 10.10.12 Remote Support

The Remote Control screen allows Pacific Power’s technical support staff to access the unit remotely if granted permission. Internet access is required for this feature.



### 10.10.13 Import / Export



A compressed file containing complete system configuration data for the power source can be exported to a file and imported back into the unit as needed. Files are .7z compressed to maximize storage space. Use the Export button on the right to export (save) current configuration data. Use the Browse button to select and import (load) a previously saved configuration file.



### 10.10.14 Firmware Update

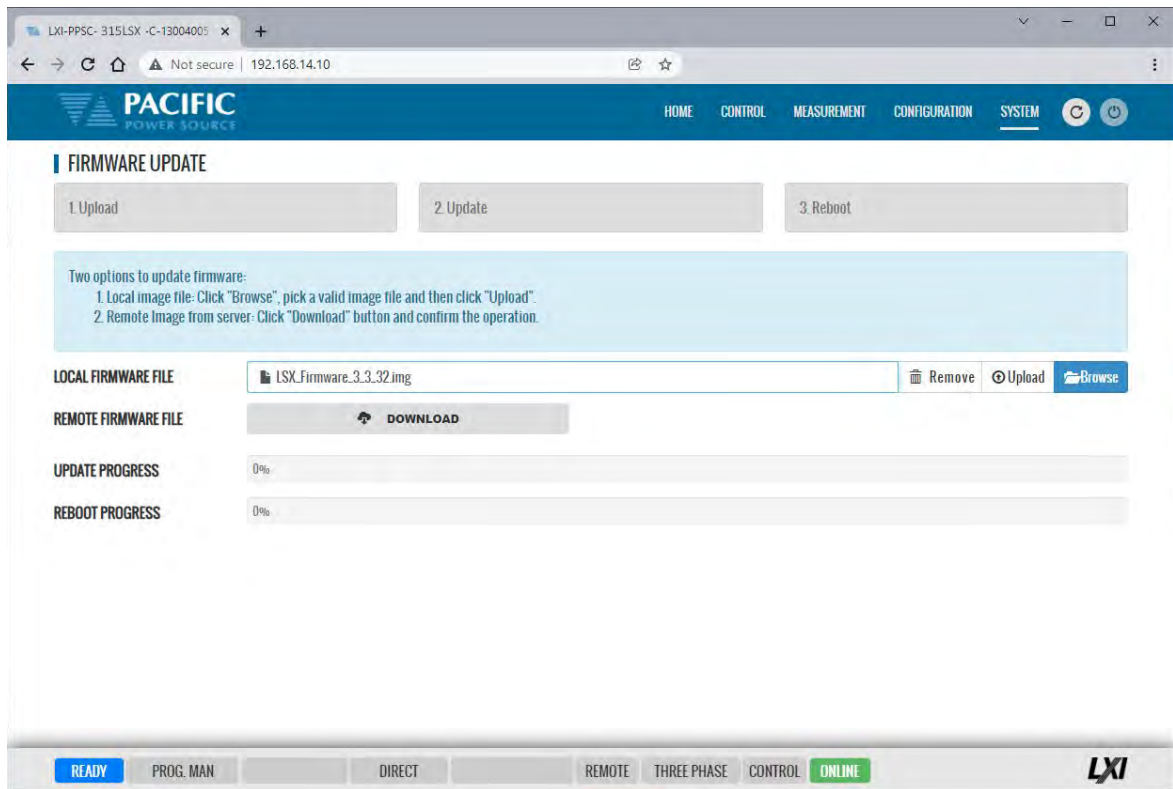
The Firmware update screen can be used to install new firmware for a file. New firmware may be distributed by email or from Pacific’s FTP site. Note that the OUTPUT of the unit must be OFF to perform a firmware update.

If you received a firmware image file (.img extension):

- Use the  button to select it from the drive location you saved it to.
- Then use the  button to upload new firmware to the power source.

To install new firmware from the Pacific Power FTP server:

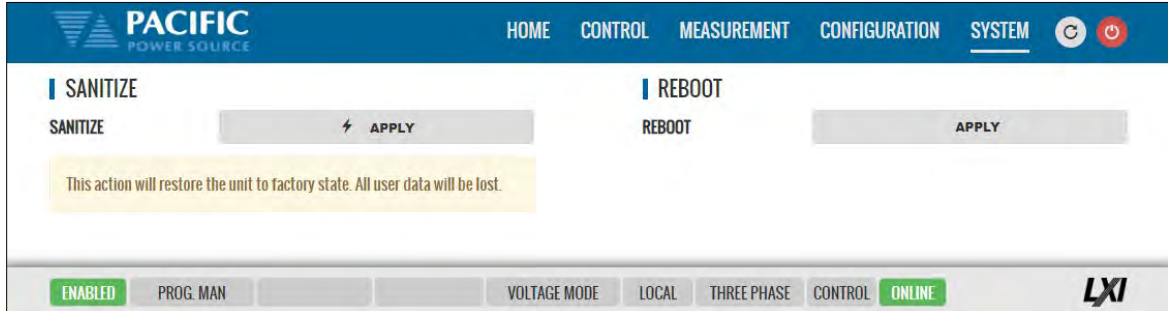
- Click the  button.



### 10.10.15 Sanitize and Reboot

This screen allows the unit to be cleared of all user settings. This applies to waveforms, settings, transients etc. The unit will be reset to factory default conditions.

The Reboot allows the power source to be rebooted (reset) without cycling AC input power.



### 10.11 Additional Functions

Additional function may be added over time through firmware updates that may not be covered by this user manual revision. If so, check the Pacific Power website for update manual versions. ( [www.pacificpower.com](http://www.pacificpower.com) ).

# 11 Calibration

## 11.1 Calibration Interval

All units are shipped new from the factory with NIST traceable calibration. It is recommended to perform an annual calibration check to ensure performance to specifications. Under normal circumstances, no adjustment will be needed but can be made as part of the user calibration coefficients.

## 11.2 Closed Case User Calibration

This section covers routine calibration that can be performed by the user. User calibration does not affect the factory set calibration coefficients that were determined and set at the time of shipment to ensure compliance with published specifications. Rather, user calibration can be used to obtain enhanced performance at typical operating conditions by adjusting these user coefficients at these conditions. For example, if the unit is used primary for testing 400Hz, three phase 115V L-N three phase operation, calibrating the user coefficients to these operating conditions against an external precision reference can provide enhanced performance versus published specifications (See Section 4, “Technical Specifications”).

Since user calibration does not affect factory calibration settings, resetting all user calibration coefficients does not invalidate the units specified performance and it can be used with all user coefficients reset as needed.

**Note:** There are no analog adjustment pots in this instrument and all calibration can be performed from the front panel or over one of the digital control interfaces.

## 11.3 Equipment Required

The following list of equipment or equivalent is required to perform routine annual calibration of the instrument. Current sensor options are determined by need for AC, DC or both.

Item	Make	Model	Notes
1	Keysight	34465A	6 ½ Digit DMM or equivalent
2	Current Transformer (AC Only)	Pearson	Model 110, 65 Arms Max. 5000Apk Max. 0.1V/A +1/-0%, Rout = 50 Ohms <a href="https://www.pearsonelectronics.com/">https://www.pearsonelectronics.com/</a> <a href="https://pearsonelectronics.com/pdf/110.pdf">https://pearsonelectronics.com/pdf/110.pdf</a>
3	Current Transformer (AC)	LEM	Pearson Current Transformer CURRENT MONITOR MODEL 110 <a href="https://www.pearsonelectronics.com/">https://www.pearsonelectronics.com/</a>

Table 11-1: Required Calibration Equipment

## 11.4 Calibration Procedures

Calibration of output and measurements is performed by a single procedure so there is no need to calibrate each separately. Calibration involves voltage and current full scale and offset on each phase. For three-phase mode, this means there are twelve calibration points, for single-phase mode, there are four.

The calibration can be performed manually using the Calibration menu (refer to Section 6.8.9 for the location of the Calibration menu) or through the build-in web server using the web browser

interface. Refer to Section 10.10.10, “Calibration” for access to the Web based calibration screens.

### 11.4.1 Voltage Calibration - Offset

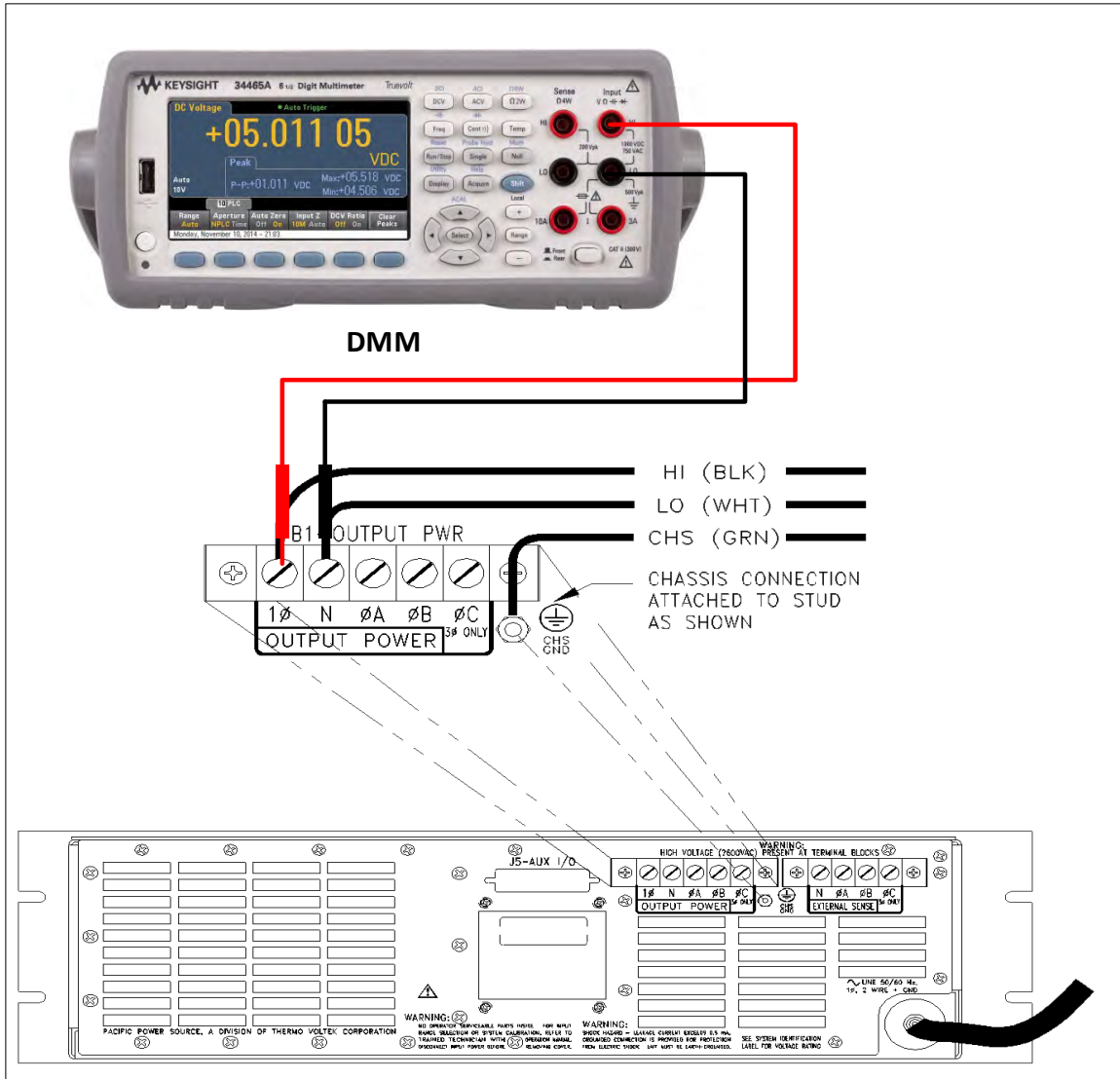
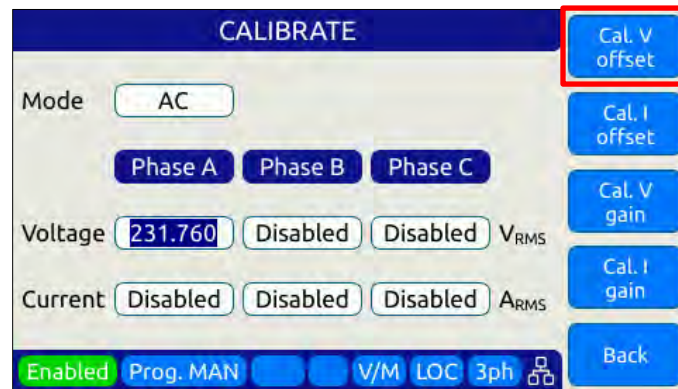


Table 11-2: Setup for Voltage Offset Calibration

The procedure to calibrate DC voltage offset is:

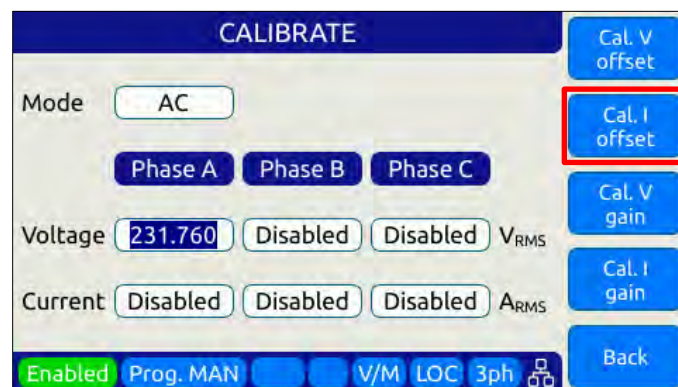


1. Select the Calibration entry from the “**System**” menu
2. Press the “Calibrate” soft key to enter calibration mode
3. Short all phases to neutral using a shorting jumper
4. You can connect the DMM to the output of phase A as shown in the figure above but it is not required for this calibration step.
5. **IMPORTANT:** Program AC voltage to all **zero volts** to avoid any current from flowing into the shorted outputs. Use PROGRAM screen to make sure AC settings are zero.
6. Enable the Output with the output shored.
7. Press "Cal V. offset" soft key
8. Wait for the V offset coefficients for all phases to be calculated and displayed
9. Remove the shorting jumper when done

**Note:** The Mode, Voltage and Current edit boxes do not affect this function.

#### 11.4.2 Current Calibration – Offset (Direct Coupled V Range)

The procedure to calibrate current offset is:



1. Select the Calibration entry from the “**System**” menu
2. Press the “Calibrate” soft key to enter calibration mode
3. Do not connect any load to the output

4. Enable the Output with no load connected
5. Press "Cal I. offset" soft key
6. Wait for the I offset coefficients for all phases to be calculated and displayed

**Note:** The Mode, Voltage and Current edit boxes do not affect this function.

### 11.4.3 Voltage Calibration - Gain

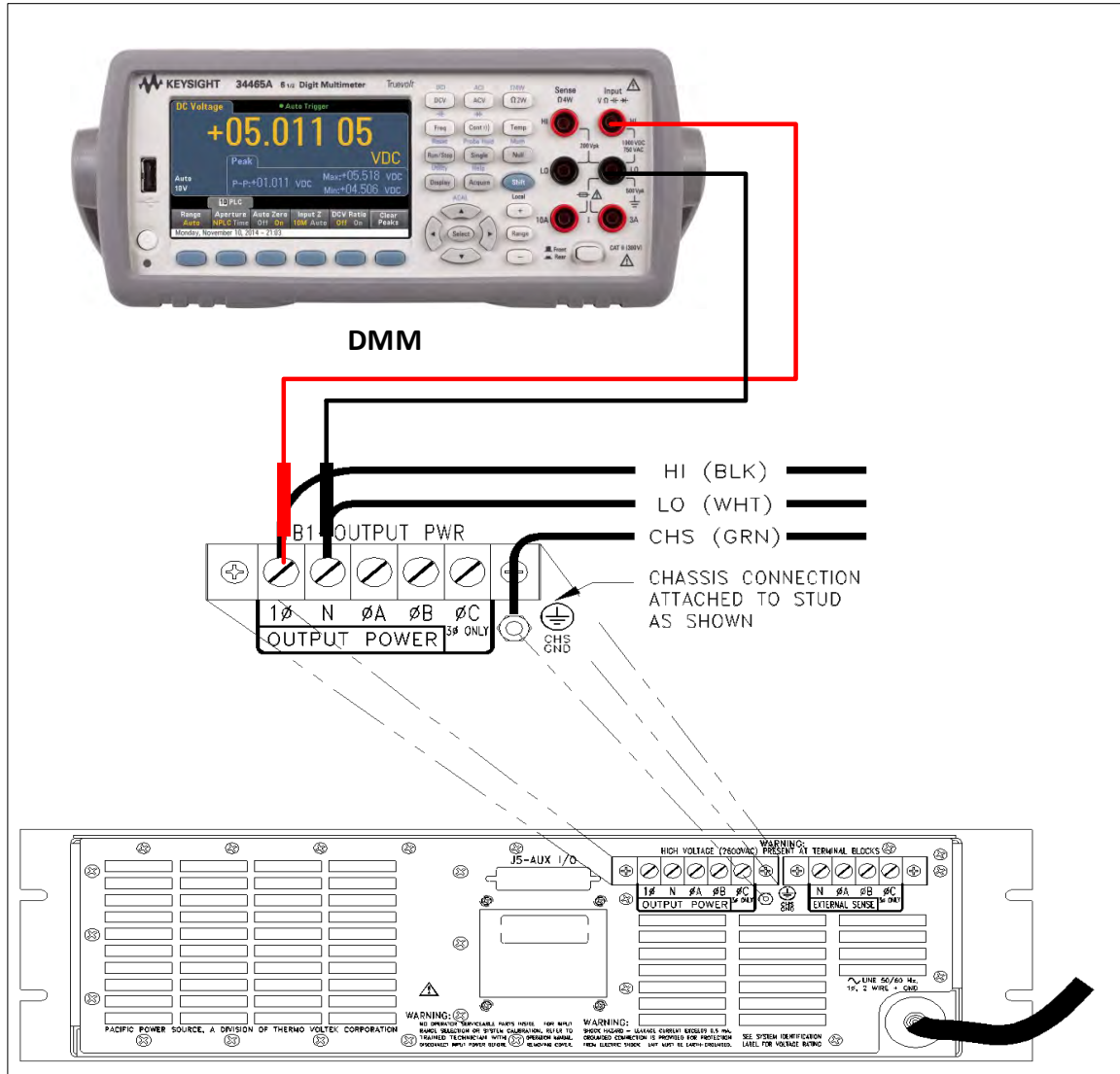
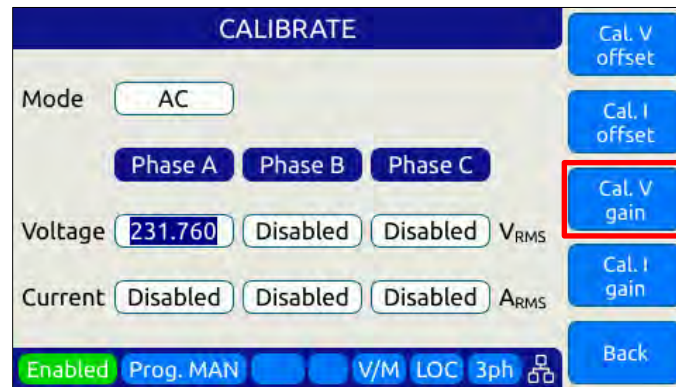


Figure 11-1: Voltage Calibration Equipment Setup – 1 or 3 Phase Mode – Phase A



The procedure to calibrate voltage gain is:



1. Select the Calibration entry from the “System” menu
2. Press the “Calibrate” soft key to enter calibration mode
3. Do not connect any load to the output
4. Program AC voltage to full scale  $V_{rms}$  L-N for AC mode calibration on all phases. Use the PROGRAM screen for this.
5. For AC mode calibration, set the Frequency to the most commonly used value depending on typical applications
6. NOTE: If the user calibration is targeted for specific operating conditions, for example  $V_{ac} = 115V$  L-N and  $Freq = 400$  Hz, use these settings instead of those suggested in steps 4 and 5
7. Enable the Output with no load connected
8. Enter the DMM VAC readings for all three phase in the respective Voltage data entry text boxes in the Calibration screen. Move the DMM probe from phase A, to B to C respectively to obtain each phase reading.
9. Press "Cal V. gain" soft key
10. Wait for the V gain coefficients for all phases to be calculated and displayed

### 11.4.4 Current Gain Calibration Setup Diagrams

For current calibration, a resistive load equivalent to 90% of maximum available RMS phase current for the phase mode selected is recommended. It is permissible to use only one load and move it between phases for three-phase mode calibration. For single-phase mode current calibration, a load capable of supporting 90% of maximum available single-phase current is recommended. The A, B and C outputs must be shorted together for single-phase mode operation. The optional Single Phase Shorting Connector (P/N 160086) can be used to accomplish this.

**Note:** To guarantee that the current doesn't change during the calibration process, it is recommended that the unit is operated at current limit, but reducing its set point to the desired value. It is also recommended to use a stable load that provides a constant linear impedance to the unit.

A suitable current shunt must be connected in series with the load as shown below for three-phase mode. The sense terminals of the current shunt must be connected to the DMM Voltage input.

#### Three Phase Mode Setup

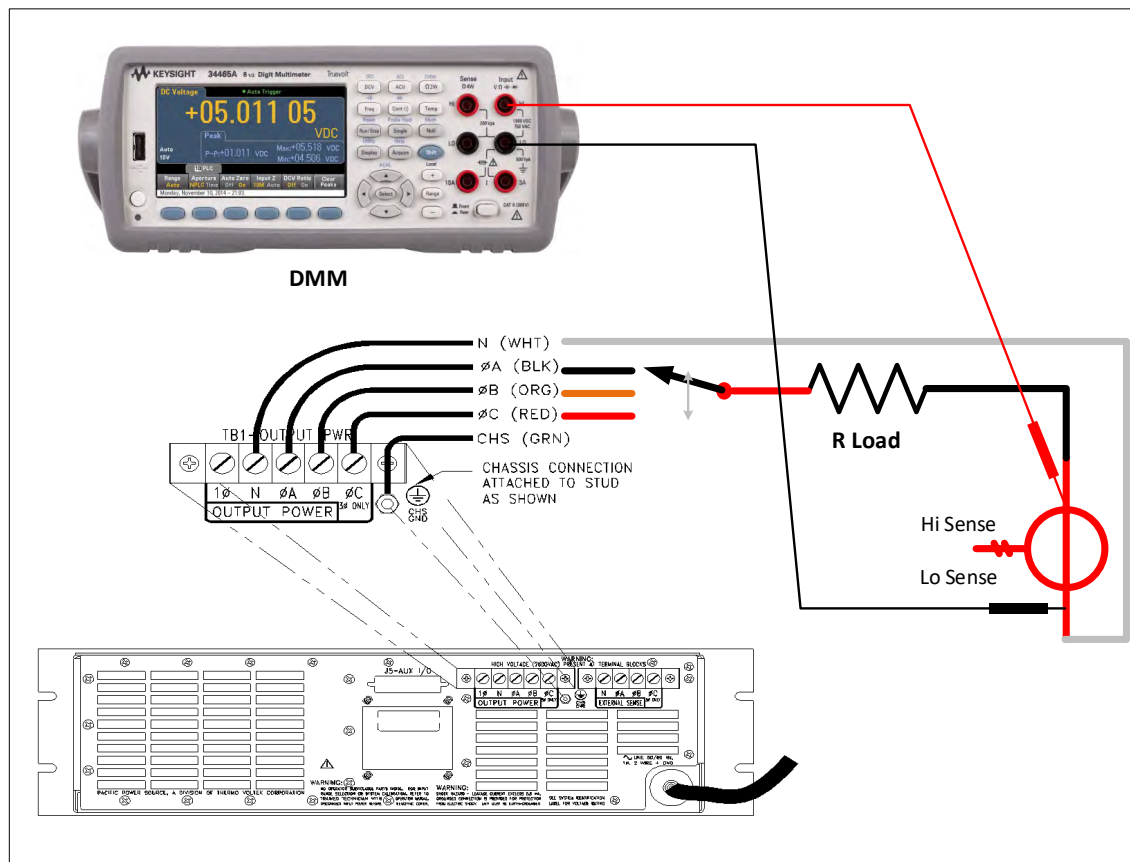


Figure 11-2 Current Calibration Equipment Setup – 3 Phase Mode – Phase A

### Single Phase Mode Setup

For Single-phase mode current Calibration, the load must have the appropriate size. See next section for recommended load value by model and phase mode.

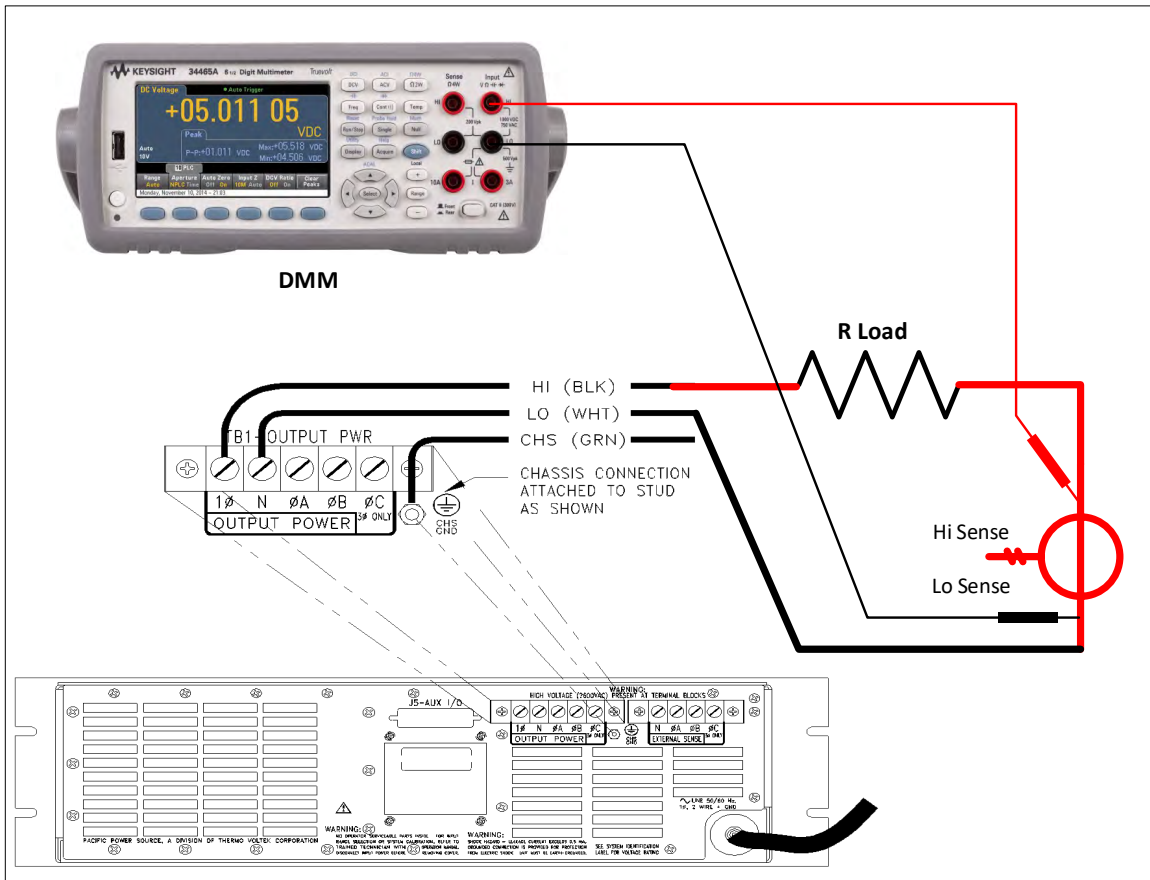


Figure 11-3: Current Calibration Equipment Setup – 1 Phase Mode

### 11.4.1 Current Calibration Load Values

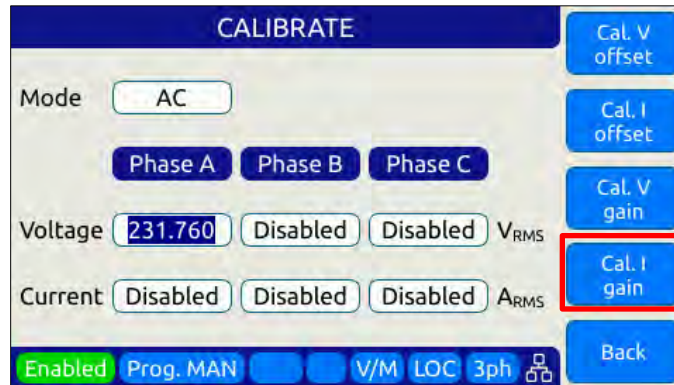
Full-scale current gain calibration is best performed at current levels that are around 90% of full-scale current. Since the LSX Series® has only a single voltage range, maximum RMS current is available at 120Vrms L-N for each phase. For single-phase mode, the current is three times higher. Thus, to obtain 90% of load current, resistor value that is sized to draw this current level at around 120Vrms is required. Since the maximum current varies by model and phase mode, the table below shows the recommended resistor values or resistive load bank settings.

Model	Rating/phs VA	Three & Two Phase Mode			Single Phase Mode		
		Max. I <sub>rms</sub> /phs	Calibration Current	Recommended R Load (Ohm) @ 120Vac	Max/ I <sub>rms</sub>	Calibration Current	Recommended R Load (Ohm) @ 120 Vac
115LSX	1500				16.0	12.0	10 Ω
120LSX	2000				20.0	18.0	6.2 Ω
140LSX	4000				32.0	28.0	4.3 Ω
160LSX	6000				48.0	40.0	3.0 Ω
315LSX	500	4.0	3.3	36 Ω	16.0	12.0	10 Ω
320LSX	667	7.0	6.6	18 Ω	20.0	18.0	6.2 Ω
345LSX	1500	12.0	10.9	12 Ω	32.0	28.0	4.3 Ω
360LSX	2000	16.0	14.6	8.2 Ω	48.0	40.0	3.0 Ω

Table 11-3: Calibration Load Values by Model and Phase Mode

### 11.4.2 Current Calibration - Gain

The procedure to calibrate current gain is:



1. Select the Calibration entry from the “**System**” menu
2. Press the “Calibrate” soft key to enter calibration mode
3. Connect the required resistive load value to the output of phase A or all three outputs if three loads are available.
4. Program AC voltage to 120.0 Vrms L-N on all phases
5. Set the Frequency to the most commonly used value depending on typical applications
6. Enable the Output
7. Allow the load current to stabilize by monitoring the DMM current reading for each phase.
8. Enter the DMM VAC readings for all three phase in the respective Current data entry text boxes in the Calibration screen. If only one shunt and load is available, repeat the above steps for phase B and C making sure to turn OFF the output before moving the load and shunt to the next phase.
9. Press "Cal I. gain" soft key
10. Wait for the I gain coefficients for all phases to be calculated and displayed

### 11.4.3 Exit Calibration Mode

To exit the calibration mode once done, press the “**Back**” software.

## 12 Warnings & Error Messages

### 12.1 Preface

During normal operation, a series of error and/ or warning messages may be displayed on the front panel LCD display or reported by the error queue over one of the remote control interfaces. This section of the manual lists available warning and error messages in numerical order and provided some additional information on their meaning and possible causes. Where relevant, suggested remedies to resolve any conditions are included as well.

**Note:** There are some Error and Warning messages that may appear in the Errors & Events that are **NOT** listed in the next section. In case you encounter an unlisted error or warning message and code, contact Pacific Power customer service ([support@pacificpower.com](mailto:support@pacificpower.com)) and describe the number and description to obtain further information.

After reporting such an event, try rebooting the power sources by cycling power as most of these conditions will clear up with a reboot.

### 12.2 Errors & Warnings Messages in Numeric Order

Source	Code	Type	Description	Possible cause
Frontpanel	-500	"SCPI standard event"	"Event: Power ON."	Power on event detected. Normal after power on.
Frontpanel	-350	"SCPI standard event"	"E&E queue overflow."	
Frontpanel	-360	"SCPI standard error"	"Communication error with an interface."	
Frontpanel	-320	"SCPI standard error"	"Storage fault."	
Frontpanel	-310	"SCPI standard error"	"System error"	
Frontpanel	-290	"SCPI standard error"	"Execution error: Memory use error."	
Frontpanel	-286	"SCPI standard error"	"Execution error: Not allowed command with the current configuration."	
Frontpanel	-285	"SCPI standard error"	"Execution error: Program syntax error."	
Frontpanel	-284	"SCPI standard error"	"Execution error: Program is currently running."	
Frontpanel	-282	"SCPI standard error"	"Execution error: Invalid program name."	
Frontpanel	-281	"SCPI standard error"	"Execution error: Cannot create program."	
Frontpanel	-256	"SCPI standard error"	"Execution error: File not found."	
Frontpanel	-253	"SCPI standard error"	"Execution error: Media is corrupted."	
Frontpanel	-240	"SCPI standard error"	"Execution error: Hardware error."	
Frontpanel	-224	"SCPI standard error"	"Execution error: Illegal parameter value."	
Frontpanel	-222	"SCPI standard error"	"Execution error: Argument out of range."	
Frontpanel	-221	"SCPI standard error"	"Execution error: Conflict in configuration setting."	
Frontpanel	-203	"SCPI standard error"	"Execution error: Permission denied."	
Frontpanel	-158	"SCPI standard error"	"Command error: String data is not allowed."	
Frontpanel	-138	"SCPI standard error"	"Command error: Numeric suffix is invalid."	

Source	Code	Type	Description	Possible cause
Frontpanel	-131	"SCPI standard error"	"Command error: Numeric suffix is out of range."	
Frontpanel	-113	"SCPI standard error"	"Command error: Undefined header."	
Frontpanel	-109	"SCPI standard error"	"Command error: Invalid number of parameters."	
Frontpanel	-108	"SCPI standard error"	"Command error: Parameters error."	
Frontpanel	-103	"SCPI standard error"	"Command error: Invalid separator."	
Frontpanel	-102	"SCPI standard error"	"Command error: Syntax error."	
Frontpanel	18	"Error"	"Unavailable transient element."	
Frontpanel	19	"Error"	"Maximum number of transient elements."	
Frontpanel	21	"Error"	"Internal communication: error during SDO upload."	
Frontpanel	22	"Error"	"Internal communication: error during SDO download."	
Frontpanel	29	"Error"	"USB interface unknown state."	
Frontpanel	31	"Error"	"Interface request packet"	Not empty.
Frontpanel	32	"Error"	"Interface request packet"	Unknown type
Frontpanel	33	"Error"	"Interface request packet"	incompatible type
Frontpanel	34	"Error"	"Interface request packet out of space."	
Frontpanel	35	"Error"	"Interface request packet"	Unavailable command request."
Frontpanel	36	"Error"	"Interface request packet has invalid arguments."	
Frontpanel	37	"Error"	"Interface response packet out of space."	
Frontpanel	42	"Error"	"Memory in use was removed."	
Frontpanel	47	"Error"	"Front panel is shutting down."	
Frontpanel	48	"Error"	"Fault state cannot be automatically reset."	
Frontpanel	51	"Error"	"The command cannot be executed in auxiliary unit."	
Frontpanel	53	"Error"	"Error during firmware update."	
Frontpanel	54	"Error"	"Calibration coefficient cannot be negative."	
Frontpanel	57	"Error"	"Waveform is not available."	
Frontpanel	58	"Error"	"Waveforms lengths are different between controllers."	
Frontpanel	59	"Error"	"Unit does not exist."	
Frontpanel	60	"Error"	"Cannot read ambient temperature."	
Frontpanel	64	"Error"	"Unexpected reset."	
Frontpanel	65	"Error"	"Front panel is in passive mode."	
Frontpanel	66	"Error"	"Invalid host name."	
Frontpanel	67	"Error"	"DC voltage setpoint cannot change due to waveform saturation."	
Frontpanel	68	"Error"	"AC voltage setpoint cannot change due to waveform saturation."	
Frontpanel	69	"Error"	"Maximum user limit is lower than setpoint."	
Frontpanel	70	"Error"	"Minimum user limit is higher than setpoint."	

Source	Code	Type	Description	Possible cause
Frontpanel	72	"Error"	"Minimum limit is higher than maximum."	
Frontpanel	73	"Error"	"Maximum limit is lower than minimum."	
Frontpanel	75	"Error"	"IP address conflict. May be duplicated."	
Frontpanel	76	"Error"	"Invalid filename."	
Frontpanel	77	"Error"	"External memory storage is not available."	
Frontpanel	78	"Error"	"Datalogger rate not allowed."	
Frontpanel	79	"Error"	"Datalogger is running"	You must stop it to change the configuration."
Frontpanel	80	"Error"	"Datalogger execution error."	
Frontpanel	83	"Error"	"Internal error: File system partition blocked."	
Frontpanel	84	"Error"	"Unable to change form while output is enabled."	
Frontpanel	85	"Error"	"Unable to clear one or more fault."	
Frontpanel	86	"Error"	"Unable to enable output. One or more primary stages failed to enable."	
Frontpanel	89	"Error"	"Digital I/Os interface conflict: Remote inhibit is active."	
Frontpanel	90	"Error"	"Digital I/Os interface conflict: Remote enable is active."	
Frontpanel	91	"Error"	"Internal error: Unknown phase mode."	
Frontpanel	92	"Error"	"Unable to disable output. One or more primary stages failed to disable."	
Frontpanel	95	"Error"	"Digital I/Os interface conflict: Serial interface flow control is active."	
Frontpanel	96	"Error"	"Datalogger storage error."	
Frontpanel	97	"Error"	"Output enable in progress."	
Frontpanel	98	"Error"	"DC Voltage not allowed in "AC mode"."	
Frontpanel	99	"Error"	"AC Voltage not allowed in "DC mode"."	
Frontpanel	100	"Error"	"DC voltage setpoint cannot change due to user limit."	
Frontpanel	101	"Error"	"AC voltage setpoint cannot change due to user limit."	
Frontpanel	102	"Error"	"DC voltage setpoint cannot change due to low range."	
Frontpanel	103	"Error"	"AC voltage setpoint cannot change due to low range."	
Frontpanel	104	"Error"	"Waveform change in progress."	
Frontpanel	105	"Error"	"Error changing service name"	
Frontpanel	106	"Error"	"Error getting service name"	
Frontpanel	109	"Error"	"Transient step mode not available on UPC compatible mode."	
Frontpanel	110	"Error"	"System is about to reboot."	
Frontpanel	111	"Error"	"Cannot reboot system."	
Frontpanel	115	"Error"	"Unable to renew the DHCP lease. Changing to Auto-IP mode."	
Frontpanel	116	"Error"	"Failed starting firmware update."	



Source	Code	Type	Description	Possible cause
Frontpanel	117	"Error"	"Unable to execute this action with output enabled."	
Frontpanel	118	"Error"	"Frequency setpoint cannot change due to waveform saturation."	
Frontpanel	119	"Error"	"Frequency setpoint cannot change due to user limit."	
Frontpanel	120	"Error"	"Frequency not allowed in "DC mode"."	
Frontpanel	121	"Error"	"Waveform setpoint cannot change due to waveform saturation."	
Frontpanel	122	"Error"	"Cannot load program. Run PROG:CHECK? for more information."	
Frontpanel	125	"Error"	"Remote inhibit cannot be disabled in this model."	
Frontpanel	126	"Error"	"Line to line measurements only available with sinewaves."	
Frontpanel	127	"Error"	"Digital I/Os interface conflict: Single-Phase relay control is active."	
Frontpanel	128	"Error"	"Digital I/Os interface conflict: Single-Phase relay cannot change with output enabled."	
Frontpanel	129	"Error"	"Digital I/Os interface conflict: Single-Phase relay cannot change due relay closed."	
Frontpanel	130	"Error"	"Unable to disable output. One or more inverter stages failed to disable."	
Frontpanel	131	"Error"	"Cannot set EEPROM field"	
Frontpanel	132	"Error"	"EEPROM field already set"	
Frontpanel	133	"Error"	"Cannot read EEPROM field"	
Frontpanel	148	"Error"	"Serial number mismatch: Front panel does not match power stages."	
Frontpanel	150	"Error"	"Suffix not allowed in single form."	
Frontpanel	151	"Error"	"Suffix not allowed in split form."	
Frontpanel	152	"Error"	"Peak current limit setting is too low for the desired voltage and frequency."	
Frontpanel	153	"Error"	"Program transient trigger input is disabled."	
Frontpanel	154	"Error"	"Steady state not yet stabilized."	
Frontpanel	155	"Error"	"Trigger output not available in this model."	
Frontpanel	156	"Error"	"Trigger input not available in this model."	
Frontpanel	157	"Error"	"Filter size must be an odd number."	
Frontpanel	158	"Error"	"Voltage mode not available in UPC compatible mode."	
Frontpanel	159	"Error"	"Waveform is unique in UPC compatible mode."	
Frontpanel	160	"Error"	"Phase is 180 for split in UPC compatible mode."	
Frontpanel	161	"Error"	"Voltage AC is unique in UPC compatible mode."	
Frontpanel	162	"Error"	"CSC is always disabled during transient in UPC compatible mode."	
Frontpanel	163	"Error"	"Auto RMS is always enabled in UPC compatible mode."	
Frontpanel	166	"Error"	"Unable to set extended voltage because frequency is outside the allowed range."	

Source	Code	Type	Description	Possible cause
Frontpanel	169	"Error"	"Unable to update setpoint because it is outside the allowed range of extended voltage mode."	
Frontpanel	172	"Error"	"Command not allowed during power stage firmware update."	
Frontpanel	173	"Error"	"Cannot change Current RMS Overload mode with output enabled."	
Frontpanel	174	"Error"	"Strobe feature not available in this model."	
Frontpanel	175	"Error"	"Feature not available in this model."	
Frontpanel	176	"Error"	"Setpoints cannot be changed while transient program is running."	
Frontpanel	177	"Error"	"Cycle reset is always enabled in UPC compatible mode."	
Frontpanel	178	"Error"	"Command not available in this unit model."	
Frontpanel	179	"Error"	"Digital output is being used for transformer option."	
Frontpanel	180	"Error"	"Unknown processor type detected. Run unit discovery to recover."	
Frontpanel	181	"Error"	"Undiscovered node detected. Run unit discovery to recover."	
Frontpanel	182	"Error"	"Incorrect parallel unit count"	
Frontpanel	183	"Error"	"Invalid processor type"	
Frontpanel	184	"Error"	"Daisy chain invalid type"	
Frontpanel	185	"Error"	"Undiscovered controller node was detected. "	
Frontpanel	186	"Error"	"No master front panel was detected."	
Frontpanel	187	"Error"	"More than enabled master controller is was detected. Going to inactive state."	
Frontpanel	188	"Error"	"One or more units are not energized or have a failure."	
Frontpanel	189	"Error"	"Incompatible node detected."	
Frontpanel	190	"Error"	"Master unit nodes not found."	
Frontpanel	191	"Error"	"Fastscan failed."	
Frontpanel	192	"Error"	"Undetectable node exists."	
Frontpanel	193	"Error"	"An invalid firmare type exists."	
Frontpanel	601	"Error"	"Frequency is too high to enable xfmr coupling."	
Frontpanel	602	"Error"	"Extended voltage range is not allowed when overload modes are enabled."	
Frontpanel	603	"Error"	"Frequency is too high for extended voltage mode."	
Frontpanel	604	"Error"	"Cannot change extended voltage mode with output enabled."	
Frontpanel	605	"Error"	"Cannot enable current overload mode when extended voltage range is enabled."	
Frontpanel	606	"Error"	"Cannot enable extended frequency when extended voltage range is enabled."	
Frontpanel	609	"Error"	"Setpoint out of range due to extended frequency mode."	

Source	Code	Type	Description	Possible cause
Frontpanel	610	"Error"	"Unable to update setpoint because it is outside the allowed range of extended frequency mode."	
Frontpanel	611	"Error"	"Error during power stage firmware update."	
Frontpanel	612	"Error"	"Phase rotation is always negative in UPC compatible mode."	
Frontpanel	613	"Error"	"Cannot change split phase mode with output enabled."	
Frontpanel	614	"Error"	"Serial port flow control not available in this unit."	
Frontpanel	615	"Error"	"Too many commands per line."	
Frontpanel	618	"Error"	"Cannot change output impedance state with output enabled."	
Frontpanel	619	"Error"	"Cannot change output impedance mode with output enabled."	
Frontpanel	620	"Error"	"Inductive impedance not available in UPC compatible mode."	
Frontpanel	621	"Error"	"Read only file or folder."	
Frontpanel	622	"Error"	"Argument requires more decimals."	
Frontpanel	624	"Error"	"Digital I/Os interface conflict: Serial interface is active."	
Frontpanel	625	"Error"	"New IO firmware available. Must split system in two to perform update."	
Frontpanel	626	"Error"	"Cannot export configurations."	
Frontpanel	627	"Error"	"Cannot import configurations."	
Frontpanel	628	"Error"	"Version mismatch error."	
Frontpanel	629	"Error"	"Internal connection error with the power stage."	
Frontpanel	630	"Error"	"Fault during output enable."	
Frontpanel	631	"Error"	"Only analog input channel 4 is available in this model."	
Frontpanel	632	"Error"	"Cannot convert cycle based transient to time based."	
Frontpanel	633	"Error"	"Incorrect password."	
Frontpanel	635	"Error"	"This setpoint is being set by an analog input."	
Frontpanel	636	"Error"	"Image model not compatible."	
Frontpanel	637	"Error"	"Frontpanel not compatible."	
Frontpanel	638	"Error"	"Cannot load pulse."	
Frontpanel	640	"Error"	"Parameter below minimum saturation."	
Frontpanel	641	"Error"	"Parameter below minimum range."	
Frontpanel	642	"Error"	"Parameter below minimum unit scope."	
Frontpanel	643	"Error"	"Parameter below minimum user limit."	
Frontpanel	644	"Error"	"Parameter below voltage mode."	
Frontpanel	645	"Error"	"Parameter above maximum saturation."	
Frontpanel	646	"Error"	"Parameter above maximum range."	
Frontpanel	647	"Error"	"Parameter above maximum unit scope."	

Source	Code	Type	Description	Possible cause
Frontpanel	648	"Error"	"Parameter above maximum user limit."	
Frontpanel	649	"Error"	"Parameter above voltage mode."	
Frontpanel	650	"Error"	"RT bus communication error"	FP will use CAN when possible."
Frontpanel	651	"Error"	"Folder does not exist."	
Frontpanel	652	"Error"	"File does not exist."	
Frontpanel	71	"Warning"	"Setpoint reduced due to low range."	
Frontpanel	107	"Warning"	"Redundant segments were combined."	
Frontpanel	108	"Warning"	"Redundant steps were combined."	
Frontpanel	144	"Warning"	"Internal battery needs to be replaced."	
Frontpanel	164	"Warning"	"Warning: CSC is enabled and Auto-RMS is disabled. Output RMS may not be regulated properly."	
Frontpanel	165	"Warning"	"Maximum AC voltage limit was reduced due to extended voltage range."	
Frontpanel	167	"Warning"	"Power limits were reduced due to extended voltage range."	
Frontpanel	168	"Warning"	"AC voltage setpoints and/or AC voltage maximum limit were reduced due to extended voltage range."	
Frontpanel	171	"Warning"	"Warning: Repeated waveform alias."	
Frontpanel	600	"Warning"	"AC voltage setpoint was automatically reduced to 0 Vrms."	
Frontpanel	607	"Warning"	"Power limits were reduced due to extended frequency mode."	
Frontpanel	608	"Warning"	"Current limits were reduced due to extended frequency mode."	
Frontpanel	616	"Warning"	"Resistive impedance was automatically reduced."	
Frontpanel	617	"Warning"	"Inductive impedance was automatically reduced."	
Frontpanel	623	"Warning"	"Warning: Ambient temperature approaching limit."	
Frontpanel	634	"Warning"	"Frontpanel firmware image model does not match frontpanel model."	
Frontpanel	653	"Warning"	"Unit in emulation mode."	
Frontpanel	654	"Warning"	"Feature disabled while interharmonic is enabled."	
Frontpanel	331	"Fault"	"Unit discovery fault. Run unit discovery to recover."	
Frontpanel	332	"Fault"	"Undiscovered unit/node detected. Run unit discovery to recover."	
Frontpanel	334	"Fault"	"Power failure."	
Frontpanel	335	"Fault"	"Remote inhibit was issued from remote interface."	
Frontpanel	336	"Fault"	"System about to reboot."	
Frontpanel	338	"Fault"	"One or more enhanced controllers did not get enabled."	
Frontpanel	339	"Fault"	"One or more inverters did not get enabled."	

Source	Code	Type	Description	Possible cause
Frontpanel	340	"Fault"	"One or more primaries did not get enabled."	
Frontpanel	343	"Fault"	"Mismatch between hardware revision of units in parallel."	
Frontpanel	344	"Fault"	"Power stage firmware update failed. Run SYSTEM:FW:INT:UPDATE:STAT? for more information. Run unit discovery to recover."	
Frontpanel	345	"Fault"	"Firmware update was interrupted"	recovery is needed. Run unit discovery to recover."
Frontpanel	346	"Fault"	"GPIB hardware not found in this unit."	"_"
Frontpanel	347	"Fault"	"GPIB hardware detected"	unit model mismatch."
Frontpanel	348	"Fault"	"IO hardware not found in this unit."	"_"
Frontpanel	349	"Fault"	"IO hardware detected"	unit model mismatch."
Frontpanel	351	"Fault"	"Transformer hardware detected"	unit model mismatch."
Frontpanel	352	"Fault"	"Ambient temperature exceeded maximum limit."	
Frontpanel	353	"Fault"	"Enhanced controller hardware not found in this unit."	
Frontpanel	354	"Fault"	"Enhanced controller hardware detected"	
Frontpanel	355	"Fault"	"Mismatch between models of units in parallel."	
Frontpanel	356	"Fault"	"Unit model mismatch."	
Frontpanel	329	"Internal fault"	"Global fault detected."	
Frontpanel	330	"Internal fault"	"Global fault detected. Possible unenergized unit or node."	
Frontpanel	333	"Internal fault"	"Node in non-operational mode. Run unit discovery to recover."	
Frontpanel	337	"Internal fault"	"Missed node."	
Frontpanel	341	"Internal fault"	"Firmware version mismatch. Power stage version is older than expected. Contact technical support."	
Frontpanel	342	"Internal fault"	"Firmware version mismatch. Front panel version is older than expected. Contact technical support."	
Frontpanel	350	"Internal fault"	"Analog inputs cannot be read."	
Frontpanel	357	"Internal fault"	"Digital inputs cannot be read."	
Frontpanel	358	"Internal fault"	"Did not receive MDO 1 - Controller A."	
Frontpanel	359	"Internal fault"	"Did not receive MDO 2 - Controller A."	
Frontpanel	360	"Internal fault"	"Did not receive MDO 3 - Controller A."	
Frontpanel	361	"Internal fault"	"Did not receive MDO 4 - Controller A."	
Frontpanel	362	"Internal fault"	"Did not receive MDO 5 - Controller A."	
Frontpanel	363	"Internal fault"	"Did not receive MDO 6 - Controller A."	
Frontpanel	364	"Internal fault"	"Did not receive MDO 7 - Controller A."	
Frontpanel	365	"Internal fault"	"Did not receive MDO 8 - Controller A."	
Frontpanel	366	"Internal fault"	"Did not receive MDO 9 - Controller A."	

Source	Code	Type	Description	Possible cause
Frontpanel	367	"Internal fault"	"Did not receive MDO 10 - Controller A."	
Frontpanel	368	"Internal fault"	"Did not receive MDO 1 - Controller B."	
Frontpanel	369	"Internal fault"	"Did not receive MDO 2 - Controller B."	
Frontpanel	370	"Internal fault"	"Did not receive MDO 3 - Controller B."	
Frontpanel	371	"Internal fault"	"Did not receive MDO 4 - Controller B."	
Frontpanel	372	"Internal fault"	"Did not receive MDO 5 - Controller B."	
Frontpanel	373	"Internal fault"	"Did not receive MDO 6 - Controller B."	
Frontpanel	374	"Internal fault"	"Did not receive MDO 7 - Controller B."	
Frontpanel	375	"Internal fault"	"Did not receive MDO 8 - Controller B."	
Frontpanel	376	"Internal fault"	"Did not receive MDO 1 - Controller C."	
Frontpanel	377	"Internal fault"	"Did not receive MDO 2 - Controller C."	
Frontpanel	378	"Internal fault"	"Did not receive MDO 3 - Controller C."	
Frontpanel	379	"Internal fault"	"Did not receive MDO 4 - Controller C."	
Frontpanel	380	"Internal fault"	"Did not receive MDO 5 - Controller C."	
Frontpanel	381	"Internal fault"	"Did not receive MDO 6 - Controller C."	
Frontpanel	382	"Internal fault"	"Did not receive MDO 7 - Controller C."	
Frontpanel	383	"Internal fault"	"Did not receive MDO 8 - Controller C."	
Frontpanel	1	"Internal error"	"Unknown fault or error."	
Frontpanel	2	"Internal error"	"Cannot initialize command thread."	
Frontpanel	3	"Internal error"	"Cannot initialize global semaphore."	
Frontpanel	4	"Internal error"	"Cannot create SCPI status object."	
Frontpanel	5	"Internal error"	"Cannot create network manager object."	
Frontpanel	6	"Internal error"	"Cannot initialize CANOpen stack."	
Frontpanel	7	"Internal error"	"Cannot initialize process class array."	
Frontpanel	8	"Internal error"	"Cannot initialize local CANOpen object dictionary."	
Frontpanel	9	"Internal error"	"Cannot create FastCGI interface."	
Frontpanel	10	"Internal error"	"Cannot create TCP interface."	
Frontpanel	11	"Internal error"	"Cannot create TELNET interface."	
Frontpanel	12	"Internal error"	"Cannot create UART serial interface."	
Frontpanel	13	"Internal error"	"Cannot create USB serial interface."	
Frontpanel	14	"Internal error"	"Cannot create keyboard interface."	
Frontpanel	15	"Internal error"	"Cannot create front panel interface."	
Frontpanel	16	"Internal error"	"Cannot create SCPI program interface."	
Frontpanel	17	"Internal error"	"Cannot cast process class in runtime."	
Frontpanel	20	"Internal error"	"Unknown operation."	
Frontpanel	23	"Internal error"	"Unavailable node."	
Frontpanel	24	"Internal error"	"Cannot initialize GPIO library."	
Frontpanel	25	"Internal error"	"Process class: not implemented type."	
Frontpanel	25	"Internal error"	"Cannot attach GPIO."	
Frontpanel	26	"Internal error"	"Process class: invalid initialization."	

Source	Code	Type	Description	Possible cause
Frontpanel	27	"Internal error"	"SCPI program dynamic cast."	
Frontpanel	28	"Internal error"	"Cannot initialize node discovery."	
Frontpanel	38	"Internal error"	"Static null pointer."	
Frontpanel	39	"Internal error"	"Cannot create file system object"	
Frontpanel	40	"Internal error"	"Linux system call error"	
Frontpanel	41	"Internal error"	"XML library error."	
Frontpanel	43	"Internal error"	"Cannot create fault manager interface."	
Frontpanel	44	"Internal error"	"Global fault UIO driver."	
Frontpanel	45	"Internal error"	"Global fault interrupt disabled."	
Frontpanel	46	"Internal error"	"Cannot create global fault thread."	
Frontpanel	49	"Internal error"	"Cannot initialize communications reset mutex."	
Frontpanel	50	"Internal error"	"Cannot initialize communications reset condition variable."	
Frontpanel	52	"Internal error"	"Error in internal communications heartbeat."	
Frontpanel	55	"Internal error"	"Cannot initialize waveform manager."	
Frontpanel	61	"Internal error"	"Cannot initialize firmware update manager."	
Frontpanel	62	"Internal error"	"Cannot initialize buffer manager."	
Frontpanel	81	"Internal error"	"Internal error: Socket send error."	
Frontpanel	82	"Internal error"	"Internal error: Interface request packet has incorrect CRC."	
Frontpanel	87	"Internal error"	"Internal error: Cannot get system time."	
Frontpanel	88	"Internal error"	"Internal error: Unknown sequence."	
Frontpanel	93	"Internal error"	"Internal error: Cannot configure timer."	
Frontpanel	94	"Internal error"	"Internal error: Cannot create timer."	
Frontpanel	136	"Internal error"	"NVRAM CRC mismatch"	
Frontpanel	137	"Internal error"	"NVRAM cannot open."	
Frontpanel	138	"Internal error"	"NVRAM cannot close."	
Frontpanel	139	"Internal error"	"NVRAM cannot lock."	
Frontpanel	140	"Internal error"	"NVRAM cannot unlock."	
Frontpanel	141	"Internal error"	"NVRAM cannot read."	
Frontpanel	142	"Internal error"	"NVRAM cannot write."	
Frontpanel	143	"Internal error"	"Cannot reset EEPROM."	
Frontpanel	145	"Internal error"	"NVRAM hardware error. Using temporal storage."	
Frontpanel	146	"Internal error"	"Invalid command ID."	
Frontpanel	147	"Internal error"	"Command argument not exist."	
Frontpanel	149	"Internal error"	"This does not seems to be a front panel."	
Frontpanel	2000	"Internal error"	"Command request argument: argument cannot be null."	
Frontpanel	2001	"Internal error"	"Command request argument: cannot parse unknown argument."	

Source	Code	Type	Description	Possible cause
Frontpanel	2002	"Internal error"	"Command request argument: cannot parse argument."	
Frontpanel	2003	"Internal error"	"Command request argument: cannot append string to non string argument."	
Frontpanel	2004	"Internal error"	"Command request argument: cannot serialize due to small buffer."	
Frontpanel	2005	"Internal error"	"Command request argument: cannot deserialize due to small buffer."	
Frontpanel	2006	"Internal error"	"Command request argument: cannot get string due non string argument."	
Frontpanel	2007	"Internal error"	"EEPROM Data: Write header error."	
Frontpanel	2008	"Internal error"	"EEPROM Data: Write data error."	
Frontpanel	2009	"Internal error"	"EEPROM Data: Data too big."	
Frontpanel	2010	"Internal error"	"EEPROM Data: Cannot open temporal file."	
Frontpanel	2011	"Internal error"	"EEPROM Data: Close error."	
Frontpanel	2012	"Internal error"	"EEPROM Data: Offset error."	
Frontpanel	2013	"Internal error"	"EEPROM Data: Read error."	
Frontpanel	2014	"Internal error"	"Transformer: Corrupted internal database."	
Frontpanel	2015	"Internal error"	"XFMR ratio not found."	
Frontpanel	2016	"Internal error"	"Coupling cannot be changed with output enabled."	
Frontpanel	2017	"Internal error"	"XFMR ratio cannot be changed with output enabled."	
Frontpanel	2018	"Internal error"	"Transformer option not available in this model."	
Frontpanel	2019	"Internal error"	"XFMR ratio is disabled. A XFMR ratio should be set with SYSTem:XFMR RATIO command."	
Frontpanel	2020	"Internal error"	"Transformer control circuits not detected."	
Frontpanel	2021	"Internal error"	"DC voltage not allowed with transformer coupling."	
Frontpanel	2022	"Internal error"	"Command request: command request cannot be null."	
Frontpanel	2023	"Internal error"	"Command request: command request argument is null."	
Frontpanel	2024	"Internal error"	"Command request: argument is null."	
Frontpanel	2025	"Internal error"	"Command request: argument number is null."	
Frontpanel	2026	"Internal error"	"Command request: argument number does not exist."	
Frontpanel	2027	"Internal error"	"Command request: there are no arguments."	
Frontpanel	2028	"Internal error"	"Command request: cannot serialize due small buffer."	
Frontpanel	2029	"Internal error"	"Command request: cannot deserialize due small buffer."	
Frontpanel	2030	"Internal error"	"Command request: cannot deserialize due argument count mismatch."	
Frontpanel	2031	"Internal error"	"Command request: cannot deserialize due size mismatch."	



Source	Code	Type	Description	Possible cause
Frontpanel	2032	"Internal error"	"Command request vector: request number does not exist."	
Frontpanel	2033	"Internal error"	"Command request vector: request number is null."	
Frontpanel	2034	"Internal error"	"Command request vector: request is null."	
Frontpanel	2035	"Internal error"	"Command request vector: vector is empty."	
Frontpanel	2036	"Internal error"	"Command request vector: cannot serialize due small buffer."	
Frontpanel	2037	"Internal error"	"Command request vector: cannot deserialize due small buffer."	
Frontpanel	2038	"Internal error"	"Command request vector: cannot deserialize due command count mismatch."	
Frontpanel	2039	"Internal error"	"Command request vector: cannot deserialize due size mismatch."	
Frontpanel	2040	"Internal error"	"Interface request packet: cannot deserialize due size mismatch."	
Frontpanel	2041	"Internal error"	"Command thread: cannot post command semaphore."	
Frontpanel	2042	"Internal error"	"Command thread: cannot initialize command semaphore."	
Frontpanel	2043	"Internal error"	"Debug message file: seek file error."	
Frontpanel	2044	"Internal error"	"Debug message file: tell file error."	
Frontpanel	2045	"Internal error"	"Debug message file: close file error."	
Frontpanel	2046	"Internal error"	"Debug message file: open file error."	
Frontpanel	2047	"Internal error"	"Debug message file: write file error."	
Frontpanel	2048	"Internal error"	"Debug message file: flush file error."	
Frontpanel	2049	"Internal error"	"Debug message file: unlink file error."	
Frontpanel	2050	"Internal error"	"Debug message ring buffer: cannot allocate buffer."	
Frontpanel	2051	"Internal error"	"Debug message ring buffer: seek file error."	
Frontpanel	2052	"Internal error"	"Debug message ring buffer: tell file error."	
Frontpanel	2053	"Internal error"	"Debug message ring buffer: close file error."	
Frontpanel	2054	"Internal error"	"Debug message ring buffer: open file error."	
Frontpanel	2055	"Internal error"	"Debug message ring buffer: write file error."	
Frontpanel	2056	"Internal error"	"Debug message ring buffer: flush file error."	
Frontpanel	2057	"Internal error"	"Debug message ring buffer: unlink file error."	
Frontpanel	2058	"Internal error"	"Debug message system: print error failed."	
Frontpanel	2059	"Internal error"	"Debug message system: print output failed."	
Frontpanel	2060	"Internal error"	"Debug: cannot get core limit."	
Frontpanel	2061	"Internal error"	"Debug: cannot set core limit."	
Frontpanel	2062	"Internal error"	"Debug: cannot initialize mutex attributes."	
Frontpanel	2063	"Internal error"	"Debug: cannot set mutex attributes."	

Source	Code	Type	Description	Possible cause
Frontpanel	2064	"Internal error"	"Debug: cannot initialize mutex."	
Frontpanel	2065	"Internal error"	"Debug: cannot destroy mutex."	
Frontpanel	2066	"Internal error"	"Debug: cannot lock mutex."	
Frontpanel	2067	"Internal error"	"Debug: cannot unlock mutex."	
Frontpanel	2068	"Internal error"	"Debug: cannot allocate debug message system."	
Frontpanel	2069	"Internal error"	"Debug: cannot allocate debug message ring buffer."	
Frontpanel	2070	"Internal error"	"Debug: cannot allocate debug message file."	
Frontpanel	2071	"Internal error"	"Timer: cannot initialize mutex attributes."	
Frontpanel	2072	"Internal error"	"Timer: cannot set mutex attributes."	
Frontpanel	2073	"Internal error"	"Timer: cannot initialize mutex."	
Frontpanel	2074	"Internal error"	"Timer: cannot destroy mutex."	
Frontpanel	2075	"Internal error"	"Timer: cannot lock mutex."	
Frontpanel	2076	"Internal error"	"Timer: cannot unlock mutex."	
Frontpanel	2077	"Internal error"	"Timer: cannot allocate mark."	
Frontpanel	2078	"Internal error"	"Timer: cannot get time."	
Frontpanel	2079	"Internal error"	"Timing: cannot initialize mutex attributes."	
Frontpanel	2080	"Internal error"	"Timing: cannot set mutex attributes."	
Frontpanel	2081	"Internal error"	"Timing: cannot initialize mutex."	
Frontpanel	2082	"Internal error"	"Timing: cannot destroy mutex."	
Frontpanel	2083	"Internal error"	"Timing: cannot lock mutex."	
Frontpanel	2084	"Internal error"	"Timing: cannot unlock mutex."	
Frontpanel	2085	"Internal error"	"Timing: cannot allocate timer."	
Frontpanel	2086	"Internal error"	"Timing: timer not found."	
Frontpanel	2087	"Internal error"	"Command response item: cannot get string of non string type."	
Frontpanel	2088	"Internal error"	"Command response item: cannot get two items."	
Frontpanel	2089	"Internal error"	"Command response item: cannot get three items."	
Frontpanel	2090	"Internal error"	"Command response item: cannot get item."	
Frontpanel	2091	"Internal error"	"Command response item: cannot set null item."	
Frontpanel	2092	"Internal error"	"Command response item: cannot set item with null data."	
Frontpanel	2093	"Internal error"	"Command response item: cannot set null item vector."	
Frontpanel	2094	"Internal error"	"Command response item: cannot append item of different type."	
Frontpanel	2095	"Internal error"	"Command response item: item not compatible."	
Frontpanel	2096	"Internal error"	"Command response item: cannot serialize due small buffer."	
Frontpanel	2097	"Internal error"	"Command response item: cannot deserialize due small buffer."	

Source	Code	Type	Description	Possible cause
Frontpanel	2098	"Internal error"	"Command response vector: vector is empty."	
Frontpanel	2099	"Internal error"	"Command response vector: last response is null."	
Frontpanel	2100	"Internal error"	"Command response vector: response does not exist."	
Frontpanel	2101	"Internal error"	"Command response vector: cannot serialize due small buffer"	
Frontpanel	2102	"Internal error"	"Command response vector: cannot deserialize due response count mismatch."	
Frontpanel	2103	"Internal error"	"Command response vector: cannot deserialize due size mismatch."	
Frontpanel	2104	"Internal error"	"Command response: cannot set null response."	
Frontpanel	2105	"Internal error"	"Command response: cannot append null data."	
Frontpanel	2106	"Internal error"	"Command response: vector is empty."	
Frontpanel	2107	"Internal error"	"Command response: last item is null."	
Frontpanel	2108	"Internal error"	"Command response: item does not exist."	
Frontpanel	2109	"Internal error"	"Command response: cannot serialize due small buffer."	
Frontpanel	2110	"Internal error"	"Command response: cannot deserialize due item count mismatch."	
Frontpanel	2111	"Internal error"	"Command response: cannot deserialize due size mismatch."	
Frontpanel	2112	"Internal error"	"Interface response packet: cannot convert due small buffer."	
Frontpanel	2113	"Internal error"	"Interface response packet: cannot deserialize due size mismatch."	
Frontpanel	2114	"Internal error"	"DB9 GPIOs: owner not allowed."	
Frontpanel	2115	"Internal error"	"Signals: system call sigemptyset."	
Frontpanel	2116	"Internal error"	"Signals: system call sigaddset."	
Frontpanel	2117	"Internal error"	"Signals: system call pthread_sigmask."	
Frontpanel	2118	"Internal error"	"Signals: system call sigaction."	
Frontpanel	2119	"Internal error"	"Signals: cannot initialize destructor semaphore."	
Frontpanel	2120	"Internal error"	"Signals: cannot destroy destructor semaphore."	
Frontpanel	2121	"Internal error"	"Thread: cannot initialize mutex."	
Frontpanel	2122	"Internal error"	"Thread: cannot create thread."	
Frontpanel	2123	"Internal error"	"Thread: cannot cancel thread."	
Frontpanel	2124	"Internal error"	"Thread: cannot join thread."	
Frontpanel	2125	"Internal error"	"NVRAM: field is not double."	
Frontpanel	2126	"Internal error"	"NVRAM: field is not bool."	
Frontpanel	2127	"Internal error"	"NVRAM: field is not unsigned char."	
Frontpanel	2128	"Internal error"	"XML file: default document is null."	
Frontpanel	2129	"Internal error"	"XML file: cannot lock mutex."	
Frontpanel	2130	"Internal error"	"XML file: cannot unlock mutex."	

Source	Code	Type	Description	Possible cause
Frontpanel	2131	"Internal error"	"XML file: cannot lock file."	
Frontpanel	2132	"Internal error"	"XML file: cannot truncate file."	
Frontpanel	2133	"Internal error"	"XML file: cannot seek file."	
Frontpanel	2134	"Internal error"	"XML file: cannot write file."	
Frontpanel	2135	"Internal error"	"XML file: cannot flush file."	
Frontpanel	2136	"Internal error"	"XML file: cannot sync file."	
Frontpanel	2137	"Internal error"	"XML file: cannot initialize mutex attributes."	
Frontpanel	2138	"Internal error"	"XML file: cannot set mutex attribute."	
Frontpanel	2139	"Internal error"	"XML file: cannot initialize mutex."	
Frontpanel	2140	"Internal error"	"XML file: cannot unlink file."	
Frontpanel	2141	"Internal error"	"XML file: cannot convert to double."	
Frontpanel	2142	"Internal error"	"XML file: cannot convert to float."	
Frontpanel	2143	"Internal error"	"XML file: cannot convert to int."	
Frontpanel	2144	"Internal error"	"XML file: cannot convert to unsigned int."	
Frontpanel	2145	"Internal error"	"XML file: cannot convert to bool."	
Frontpanel	2146	"Internal error"	"XML file: cannot convert attribute."	
Frontpanel	2147	"Internal error"	"XML file: cannot convert attribute to bool"	
Frontpanel	2148	"Internal error"	"XML file: document is null."	
Frontpanel	2149	"Internal error"	"XML file: element is null."	
Frontpanel	2150	"Internal error"	"XML file: element data is null."	
Frontpanel	2151	"Internal error"	"XML file: attribute is null."	
Frontpanel	2152	"Internal error"	"XML file: attribute data is null."	
Frontpanel	2153	"Internal error"	"XML file: system call access failed."	
Frontpanel	2154	"Internal error"	"XML file: cannot rename file."	
Frontpanel	2155	"Internal error"	"XML file: cannot allocate document."	
Frontpanel	2156	"Internal error"	"XML file: CRC mismatch."	
Frontpanel	2157	"Internal error"	"XML file: version mismatch."	
Frontpanel	2158	"Internal error"	"XML file: cannot amend file."	
Frontpanel	2159	"Internal error"	"XML file: data out of range."	
Frontpanel	2160	"Internal error"	"XML file: cannot insert element."	
Frontpanel	2161	"Internal error"	"XML file: cannot clone element."	
Frontpanel	2162	"Internal error"	"CAN interface: cannot initialize mutex."	
Frontpanel	2163	"Internal error"	"CAN open stack: cannot initialize running mutex."	
Frontpanel	2164	"Internal error"	"CAN open stack: cannot initialize reset mutex."	
Frontpanel	2165	"Internal error"	"CAN open stack: cannot initialize CO mutex."	
Frontpanel	2166	"Internal error"	"CAN open stack: cannot initialize READ mutex."	
Frontpanel	2167	"Internal error"	"CAN open stack: cannot destroy CO mutex."	

Source	Code	Type	Description	Possible cause
Frontpanel	2168	"Internal error"	"CAN open stack: cannot destroy reset mutex."	
Frontpanel	2169	"Internal error"	"CAN open stack: cannot destroy running mutex."	
Frontpanel	2170	"Internal error"	"CAN open stack: cannot initialize CO."	
Frontpanel	2171	"Internal error"	"CAN open stack: cannot create timer thread."	
Frontpanel	2172	"Internal error"	"CAN open stack: cannot create RX thread."	
Frontpanel	2173	"Internal error"	"CAN open stack: cannot CAN socket."	
Frontpanel	2174	"Internal error"	"CAN open stack: cannot configure CAN socket."	
Frontpanel	2175	"Internal error"	"CAN open stack: cannot bind CAN socket."	
Frontpanel	2176	"Internal error"	"CAN open stack: cannot close CAN socket."	
Frontpanel	2177	"Internal error"	"CAN open stack: cannot write CAN socket."	
Frontpanel	2178	"Internal error"	"CAN open stack: write CAN socket size mismatch."	
Frontpanel	2179	"Internal error"	"CAN open stack: CAN socket not initialized."	
Frontpanel	2180	"Internal error"	"CAN open stack: cannot initialize CO timer semaphore."	
Frontpanel	2181	"Internal error"	"CAN open stack: cannot destroy CO timer semaphore."	
Frontpanel	2182	"Internal error"	"CAN main: cannot initialize background semaphore mutex."	
Frontpanel	2183	"Internal error"	"CAN main: cannot destroy background semaphore mutex."	
Frontpanel	2184	"Internal error"	"CAN main: cannot initialize background semaphore."	
Frontpanel	2185	"Internal error"	"CAN main: cannot destroy background semaphore."	
Frontpanel	2186	"Internal error"	"Discovery: cannot initialize daisy chain GPIO."	
Frontpanel	2187	"Internal error"	"Discovery: daisy chain GPIO not initialized."	
Frontpanel	2188	"Internal error"	"Discovery: cannot get processor types due small vector."	
Frontpanel	2189	"Internal error"	"Discovery: cannot get inverters due small vector."	
Frontpanel	2190	"Internal error"	"Discovery: cannot get primaries due small vector."	
Frontpanel	2191	"Internal error"	"Discovery: cannot allocate discovery."	
Frontpanel	2192	"Internal error"	"DSP commands: NMT."	
Frontpanel	2193	"Internal error"	"DSP commands: SDO download."	
Frontpanel	2194	"Internal error"	"DSP commands: SDO upload."	
Frontpanel	2195	"Internal error"	"DSP commands: LSS INCRS."	
Frontpanel	2196	"Internal error"	"DSP commands: LSS SSDC."	
Frontpanel	2197	"Internal error"	"DSP commands: LSS CNI."	
Frontpanel	2198	"Internal error"	"DSP commands: LSS SC."	
Frontpanel	2199	"Internal error"	"DSP commands: LSS FS."	
Frontpanel	2200	"Internal error"	"DSP commands: LSS PPSTFS."	

Source	Code	Type	Description	Possible cause
Frontpanel	2201	"Internal error"	"DSP commands: invalid node ID."	
Frontpanel	2202	"Internal error"	"DSP commands: invalid DSP type."	
Frontpanel	2203	"Internal error"	"DSP commands: invalid mapping number."	
Frontpanel	2204	"Internal error"	"DSP commands: invalid COB ID."	
Frontpanel	2205	"Internal error"	"DSP commands: invalid heart beat number."	
Frontpanel	2206	"Internal error"	"DSP commands: invalid tries number."	
Frontpanel	2207	"Internal error"	"DSP commands: read SDO buffer length."	
Frontpanel	2208	"Internal error"	"DSP commands: read bootloader DSP types."	
Frontpanel	2209	"Internal error"	"DSP commands: read bootloader state."	
Frontpanel	2210	"Internal error"	"DSP update commands: flag for update."	
Frontpanel	2211	"Internal error"	"DSP update commands: check device type."	
Frontpanel	2212	"Internal error"	"DSP update commands: check bootloader update state."	
Frontpanel	2213	"Internal error"	"DSP update commands: unlock flash CSM."	
Frontpanel	2214	"Internal error"	"DSP update commands: lock flash CSM."	
Frontpanel	2215	"Internal error"	"DSP update commands: erase flash sector."	
Frontpanel	2216	"Internal error"	"DSP update commands: write flash block."	
Frontpanel	2217	"Internal error"	"DSP update commands: firmware run."	
Frontpanel	2218	"Internal error"	"Condition comparison: unknown condition."	
Frontpanel	2219	"Internal error"	"Observer program: SCPI program not initialized."	
Frontpanel	2220	"Internal error"	"Command vector: invalid initialization order."	
Frontpanel	2221	"Internal error"	"Command vector: incomplete initialization."	
Frontpanel	2222	"Internal error"	"Observer vector: invalid initialization order."	
Frontpanel	2223	"Internal error"	"Observer vector: incomplete initialization."	
Frontpanel	2224	"Internal error"	"Operation file system: XML file not initialized."	
Frontpanel	2225	"Internal error"	"Operation SDO: cannot get node ID."	
Frontpanel	2226	"Internal error"	"Operation generic: command ID vector empty."	
Frontpanel	2227	"Internal error"	"Operation IEEE4882: long IDN string."	
Frontpanel	2228	"Internal error"	"Operation system: DB9 GPIOs invalid state."	
Frontpanel	2229	"Internal error"	"Operation source: DB9 GPIOs invalid state."	
Frontpanel	2230	"Internal error"	"Operation source: waveform invalid state."	
Frontpanel	2231	"Internal error"	"Operation source: XML configuration file not initialized."	
Frontpanel	2232	"Internal error"	"Operation source: XML program file not initialized."	
Frontpanel	2233	"Internal error"	"Operation simulation: invalid variable ID."	

Source	Code	Type	Description	Possible cause
Frontpanel	2234	"Internal error"	"Operation program: invalid transient status"	
Frontpanel	2235	"Internal error"	"Operation program: command not available."	
Frontpanel	2236	"Internal error"	"Firmware update manager: firmware up to date."	
Frontpanel	2237	"Internal error"	"DSP firmware update log: mutex lock error."	
Frontpanel	2238	"Internal error"	"DSP firmware update log: mutex unlock error."	
Frontpanel	2239	"Internal error"	"DSP firmware update log: error opening log file."	
Frontpanel	2240	"Internal error"	"DSP firmware update log: error flushing log file."	
Frontpanel	2241	"Internal error"	"DSP firmware update log: error closing log file."	
Frontpanel	2242	"Internal error"	"DSP firmware update log: error writing log file."	
Frontpanel	2243	"Internal error"	"DSP firmware update log: no file open to write."	
Frontpanel	2244	"Internal error"	"DSP firmware update log: class null."	
Frontpanel	2245	"Internal error"	"Application: invalid application command."	
Frontpanel	2246	"Internal error"	"Application: cannot initialize running mutex."	
Frontpanel	2247	"Internal error"	"Application: cannot initialize application mutex."	
Frontpanel	2248	"Internal error"	"Application: cannot create timer."	
Frontpanel	2249	"Internal error"	"Application: cannot configure timer."	
Frontpanel	2250	"Internal error"	"Application: cannot close timer."	
Frontpanel	2251	"Internal error"	"XML handler: cannot load XML."	
Frontpanel	2252	"Internal error"	"Application: cannot save XML."	
Frontpanel	2253	"Internal error"	"Avahi XML: folder does not exist."	
Frontpanel	2254	"Internal error"	"Avahi XML: file does not exist."	
Frontpanel	2255	"Internal error"	"Avahi XML: invalid field number."	
Frontpanel	2256	"Internal error"	"Network manager: thread not initialized."	
Frontpanel	2257	"Internal error"	"Network manager: invalid variable ID."	
Frontpanel	2258	"Internal error"	"Network manager: invalid configuration type."	
Frontpanel	2259	"Internal error"	"Network manager: netconfig call failed."	
Frontpanel	2260	"Internal error"	"Network manager: avahi call failed."	
Frontpanel	2261	"Internal error"	"Network manager: udhcp call failed."	
Frontpanel	2262	"Internal error"	"Network manager: netconfig field not found."	
Frontpanel	2263	"Internal error"	"Network manager: invalid service name."	
Frontpanel	2264	"Internal error"	"Network manager: avahi close process."	
Frontpanel	2265	"Internal error"	"External interface: invalid socket path."	
Frontpanel	2266	"Internal error"	"External interface: cannot create from socket."	

Source	Code	Type	Description	Possible cause
Frontpanel	2267	"Internal error"	"External interface: cannot bind from socket."	
Frontpanel	2268	"Internal error"	"External interface: cannot listen from socket."	
Frontpanel	2269	"Internal error"	"External interface: cannot create to socket."	
Frontpanel	2270	"Internal error"	"External interface: cannot bind to socket."	
Frontpanel	2271	"Internal error"	"External interface: cannot listen to socket."	
Frontpanel	2272	"Internal error"	"External interface: cannot initialize to socket mutex."	
Frontpanel	2273	"Internal error"	"External interface: cannot allocate thread."	
Frontpanel	2274	"Internal error"	"External interface: invalid packet type."	
Frontpanel	2275	"Internal error"	"External interface: invalid response type."	
Frontpanel	2276	"Internal error"	"XML SCPI program file: buffer is null."	
Frontpanel	2277	"Internal error"	"XML SCPI program file: buffer is small."	
Frontpanel	2278	"Internal error"	"Program is undefined."	
Frontpanel	2279	"Internal error"	"XML SCPI program file: element is null."	
Frontpanel	2280	"Internal error"	"EEPROM: call failed."	
Frontpanel	2281	"Internal error"	"EEPROM: field not found."	
Frontpanel	2282	"Internal error"	"Memories: invalid folder."	
Frontpanel	2283	"Internal error"	"Memories: invalid name."	
Frontpanel	2284	"Internal error"	"XML access file: invalid IP."	
Frontpanel	2285	"Internal error"	"XML access file: invalid alias size."	
Frontpanel	2286	"Internal error"	"XML access file: cannot convert to bool."	
Frontpanel	2287	"Internal error"	"XML access file: invalid tag."	
Frontpanel	2288	"Internal error"	"Temperature: cannot open file."	
Frontpanel	2289	"Internal error"	"Temperature: file not opened."	
Frontpanel	2290	"Internal error"	"Temperature: cannot seek file."	
Frontpanel	2291	"Internal error"	"Temperature: cannot read file."	
Frontpanel	2292	"Internal error"	"Remote: DB9 GPIO not initialized."	
Frontpanel	2293	"Internal error"	"Remote: cannot open UIO."	
Frontpanel	2294	"Internal error"	"Remote: cannot write UIO."	
Frontpanel	2295	"Internal error"	"Interface vector: cannot initialize mutex attributes."	
Frontpanel	2296	"Internal error"	"Interface vector: cannot set mutex attributes."	
Frontpanel	2297	"Internal error"	"Interface vector: cannot initialize mutex."	
Frontpanel	2298	"Internal error"	"Interface vector: cannot allocate VXI interface."	
Frontpanel	2299	"Internal error"	"Interface vector: cannot lock mutex."	
Frontpanel	2300	"Internal error"	"Interface vector: cannot unlock mutex."	
Frontpanel	2301	"Internal error"	"SCPI program: destination program cannot be manual mode."	
Frontpanel	2302	"Internal error"	"SCPI program: invalid define string."	
Frontpanel	2303	"Internal error"	"SCPI program: missing voltage A."	



Source	Code	Type	Description	Possible cause
Frontpanel	2304	"Internal error"	"SCPI program: missing voltage B."	
Frontpanel	2305	"Internal error"	"Cannot get waveform field."	
Frontpanel	2306	"Internal error"	"Cannot delete waveform in use."	
Frontpanel	2307	"Internal error"	"Waveform #1 cannot be deleted or modified."	
Frontpanel	2308	"Internal error"	"Sequential interface: cannot initialize command executed semaphore."	
Frontpanel	2309	"Internal error"	"Sequential interface: cannot initialize execute command semaphore."	
Frontpanel	2310	"Internal error"	"Sequential interface: cannot initialize pending commands mutex."	
Frontpanel	2311	"Internal error"	"IEEE488.2 status: cannot initialize mutex."	
Frontpanel	2312	"Internal error"	"IEEE488.2 status: item does not exist."	
Frontpanel	2313	"Internal error"	"Fault manager: MDO not received."	
Frontpanel	2314	"Internal error"	"Measurement logger manager: cannot write file."	
Frontpanel	2315	"Internal error"	"Synchronization: cannot initialize operation complete mutex."	
Frontpanel	2316	"Internal error"	"Synchronization: cannot initialize operation complete mutex attributes."	
Frontpanel	2317	"Internal error"	"Synchronization: cannot set operation complete mutex attributes."	
Frontpanel	2318	"Internal error"	"Synchronization: cannot initialize operation complete condition variable."	
Frontpanel	2319	"Internal error"	"SCPI parser: cannot initialize mutex."	
Frontpanel	2320	"Internal error"	"SCPI parser: cannot lock mutex."	
Frontpanel	2321	"Internal error"	"SCPI parser: cannot unlock mutex."	
Frontpanel	2322	"Internal error"	"RT Bus packet: out of space."	
Frontpanel	2323	"Internal error"	"RT Bus packet: CRC mismatch."	
Frontpanel	2324	"Internal error"	"RT Bus packet: incomplete."	
Frontpanel	2325	"Internal error"	"RT Bus send: cannot init semaphore."	
Frontpanel	2326	"Internal error"	"RT Bus send: cannot destroy semaphore."	
Frontpanel	2327	"Internal error"	"RT Bus send: mutex lock."	
Frontpanel	2328	"Internal error"	"RT Bus send: mutex unlock."	
Frontpanel	2329	"Internal error"	"RT Bus send: mutex init attributes."	
Frontpanel	2330	"Internal error"	"RT Bus send: mutex set attributes."	
Frontpanel	2331	"Internal error"	"RT Bus send: mutex init."	
Frontpanel	2332	"Internal error"	"RT Bus send: executing."	
Frontpanel	2333	"Internal error"	"RT Bus send: timeout."	
Frontpanel	2343	"Internal error"	"RT Bus driver: not initialized."	
Frontpanel	2344	"Internal error"	"RT Bus driver: mutex init attributes."	
Frontpanel	2345	"Internal error"	"RT Bus driver: mutex set attributes."	
Frontpanel	2346	"Internal error"	"RT Bus driver: mutex init."	
Frontpanel	2347	"Internal error"	"RT Bus driver: mutex destroy."	
Frontpanel	2348	"Internal error"	"RT Bus driver: mutex lock."	

Source	Code	Type	Description	Possible cause
Frontpanel	2349	"Internal error"	"RT Bus driver: mutex unlock."	
Frontpanel	2350	"Internal error"	"RT Bus driver: cannot add transaction to queue."	
Frontpanel	2351	"Internal error"	"RT Bus driver: cannot start."	
Frontpanel	2352	"Internal error"	"RT Bus driver: cannot stop."	
Frontpanel	2353	"Internal error"	"RT Bus driver: UART for node not available."	
Frontpanel	2354	"Internal error"	"RT Bus driver: queue full."	
Frontpanel	2355	"Internal error"	"RT Bus driver: cannot add to queue."	
Frontpanel	2356	"Internal error"	"RT Bus driver: cannot post semaphore."	
Frontpanel	2357	"Internal error"	"RT Bus transaction: cannot init semaphore."	
Frontpanel	2358	"Internal error"	"RT Bus transaction: cannot destroy semaphore."	
Frontpanel	2359	"Internal error"	"RT Bus transaction: executing."	
Frontpanel	2360	"Internal error"	"RTC: not initialized."	
Frontpanel	2361	"Internal error"	"RTC: mutex init attributes."	
Frontpanel	2362	"Internal error"	"RTC: mutex set attributes."	
Frontpanel	2363	"Internal error"	"RTC: mutex init."	
Frontpanel	2364	"Internal error"	"RTC: mutex destroy."	
Frontpanel	2365	"Internal error"	"RTC: mutex lock."	
Frontpanel	2366	"Internal error"	"RTC: mutex unlock."	
Frontpanel	2367	"Internal error"	"RTC: cannot add transaction to queue."	
Frontpanel	2368	"Internal error"	"RTC: cannot start."	
Frontpanel	2369	"Internal error"	"RTC: cannot stop."	
Frontpanel	2370	"Internal error"	"RTC: cannot post semaphore."	
Frontpanel	113	"Internal warning"	"Missed second heartbeat."	
Frontpanel	114	"Internal warning"	"Missed first heartbeat."	
Frontpanel	123	"Internal warning"	"Warning: input voltage in EEPROM does not match the Primary DSP. Using DSP value."	
Frontpanel	0	"Success"	"No error"	
Inverter	265	"Fault"	"Inverter gate driver fault."	
Inverter	266	"Fault"	"Internal bias supply fault."	
Inverter	267	"Fault"	"No waveform loaded. Load waveform before enabling arbitrary waveform mode."	
Inverter	268	"Fault"	"Exceeded RMS current limit."	
Inverter	269	"Fault"	"Exceeded active power limit."	
Inverter	270	"Fault"	"Exceeded apparent power limit."	
Inverter	271	"Fault"	"Internal SCIA communication error."	
Inverter	272	"Fault"	"Internal McBSP communication CRC error."	
Inverter	273	"Fault"	"Inverter current negative peak protection."	
Inverter	274	"Fault"	"Inverter current positive peak protection."	
Inverter	275	"Fault"	"DC bus voltage minimum limit exceeded."	

Source	Code	Type	Description	Possible cause
Inverter	276	"Fault"	"DC bus voltage maximum limit exceeded."	
Inverter	277	"Fault"	"Temperature protection	maximum limit."
Inverter	278	"Fault"	"Temperature protection	minimum limit."
Inverter	279	"Fault"	"Output relay voltage protection	minimum limit."
Inverter	280	"Fault"	"Output relay voltage protection	maximum limit."
Inverter	281	"Fault"	"Output terminals common mode voltage protection	minimum limit."
Inverter	282	"Fault"	"Output terminals common mode voltage protection	maximum limit."
Inverter	283	"Fault"	"Inductor current RMS protection	exceeded maximum limit for too long."
Inverter	284	"Fault"	"Inductor current DC protection	exceeded maximum limit for too long."
Inverter	285	"Fault"	"Global fault input signal detected."	
Inverter	286	"Fault"	"Fan under voltage protection."	
Inverter	287	"Fault"	"Inductor current cycle-by-cycle protection trip limit."	
Inverter	288	"Fault"	"Fan current consumption is abnormal	fan may be blocked
Inverter	292	"Fault"	"Output current has too much high frequency content	possible oscillation. RQ monitor fault."
Inverter	293	"Fault"	"Controller missed heartbeats from master front panel."	
Inverter	294	"Fault"	"Output over-voltage protection."	
Inverter	296	"Fault"	"Output current peak protection."	
Inverter	297	"Fault"	"Remote voltage sensing fault."	
Inverter	298	"Fault"	"Internal capacitors over-current protection."	
Inverter	299	"Fault"	"Internal bus over-voltage protection. Possible regenerative load."	
Inverter	300	"Fault"	"CSC loop has saturated"	
Inverter	301	"Fault"	"Output current overload. RMS current exceeded limit."	
Inverter	302	"Fault"	"Internal muxed ADC protection fault."	
Inverter	303	"Fault"	"Internal fan current regulation fault."	
Inverter	304	"Fault"	"Parallel units model mismatch."	
Inverter	289	"Internal fault"	"Hardware revision does not match expected by firmware. Firmware must be reloaded."	
Inverter	290	"Internal fault"	"Invalid node ID. Run unit discovery to recover."	
Inverter	291	"Internal fault"	"Incorrect DSP type detected. Cycle-power to re-try."	
Inverter	295	"Internal fault"	"Invalid constants loaded from EEPROM."	
Inverter	326	"Internal fault"	"Controller is not in operational node."	
Inverter	327	"Internal fault"	"Missing controller node."	
Inverter	328	"Internal fault"	"Cannot read fault information."	
Primary	200	"Fault"	"LLC primary/auxiliary current peak limit exceeded."	

Source	Code	Type	Description	Possible cause
Primary	201	"Fault"	"LLC/PFC gate driver fault or hardware OVP."	
Primary	202	"Fault"	"Controller missed heartbeats from master front panel."	
Primary	203	"Fault"	"LLC primary current average limit exceeded."	
Primary	204	"Fault"	"LLC auxiliary current average limit exceeded."	
Primary	205	"Fault"	"PFC current peak limit exceeded."	
Primary	206	"Fault"	"PFC DC bus voltage limit exceeded."	
Primary	207	"Fault"	"Gate driver fault"	input buck converter."
Primary	208	"Fault"	"Input buck switching time."	
Primary	209	"Fault"	"AC input current exceeded RMS limit for too long."	
Primary	210	"Fault"	"Unbalanced current in PFC boost converters."	
Primary	211	"Fault"	"PFC efficiency protection."	
Primary	212	"Fault"	"AC input: voltage is below minimum."	
Primary	213	"Fault"	"AC input: missing phase."	
Primary	214	"Fault"	"PFC DC bus voltage regulation lost."	
Primary	215	"Fault"	"PFC DC bus voltage limit exceeded. CLA OVP Trip"	
Primary	216	"Fault"	"Temperature 1 protection (input stage)"	exceeded maximum limit."
Primary	217	"Fault"	"Temperature 1 protection (input stage)"	exceeded minimum limit."
Primary	218	"Fault"	"Temperature 2 protection (PFC/LLC)"	exceeded maximum limit."
Primary	219	"Fault"	"Temperature 2 protection (PFC/LLC)"	exceeded minimum limit."
Primary	220	"Fault"	"Temperature 3 protection (PFC/LLC)"	exceeded maximum limit."
Primary	221	"Fault"	"Temperature 3 protection (PFC/LLC) exceeded minimum limit."	"_."
Primary	222	"Fault"	"Temperature 4 protection (main transformer)"	exceeded maximum limit."
Primary	223	"Fault"	"Temperature 4 protection (main transformer)"	exceeded minimum limit."
Primary	224	"Fault"	"Internal bias supply fault."	
Primary	230	"Fault"	"PFC output current peak protection."	
Primary	231	"Fault"	"PFC output current slow protection"	
Primary	232	"Fault"	"AC input: voltage is above maximum."	
Primary	234	"Fault"	"Firmware task execution error."	
Primary	225	"Internal fault"	"Global fault input signal detected."	
Primary	226	"Internal fault"	"Hardware does not match input voltage setting."	
Primary	227	"Internal fault"	"Primary capacitor board not detected."	
Primary	228	"Internal fault"	"Invalid node ID. Run unit discovery to recover."	

Source	Code	Type	Description	Possible cause
Primary	229	"Internal fault"	"Incorrect DSP type detected. Cycle-power to re-try."	
Primary	233	"Internal fault"	"Invalid constants loaded from EEPROM."	
Primary	261	"Internal fault"	"Controller is not in operational mode."	
Primary	262	"Internal fault"	"Missing controller node."	
Primary	263	"Internal fault"	"Cannot read fault information."	
IO board	399	"Fault"	"Transformer coupling circuits hardware fault."	
IO board	400	"Fault"	"Transformer coupling circuits not detected."	
IO board	401	"Fault"	"Remote inhibit was issued from remote interface."	
IO board	402	"Fault"	"Forced fault."	
IO board	393	"Internal fault"	"Global fault detected."	
IO board	394	"Internal fault"	"Internal board fault."	
IO board	395	"Internal fault"	"Invalid node ID. Run unit discovery to recover."	
IO board	396	"Internal fault"	"Incorrect DSP type detected. Cycle-power to re-try."	
IO board	397	"Internal fault"	"Invalid constants loaded from EEPROM."	
IO board	398	"Internal fault"	"Controller is not in operational mode."	
IO board	454	"Internal fault"	"Controller is not in operational mode."	
IO board	455	"Internal fault"	"Missing controller node."	
IO board	456	"Internal fault"	"Cannot read fault information."	
Controller	459	"Fault"	"Internal board fault."	
Controller	460	"Fault"	"No waveform loaded. Load waveform before enabling arbitrary waveform mode."	
Controller	461	"Fault"	"Exceeded user RMS current limit."	
Controller	462	"Fault"	"Exceeded user active power limit."	
Controller	463	"Fault"	"Exceeded user apparent power limit."	
Controller	478	"Fault"	"Global fault input signal detected."	
Controller	486	"Fault"	"Controller missed heartbeats from master front panel."	
Controller	487	"Fault"	"Output over-voltage protection."	
Controller	489	"Fault"	"Output current peak protection."	
Controller	492	"Fault"	"Remote sensing fault."	
Controller	493	"Fault"	"CSC loop has saturated"	
Controller	494	"Fault"	"Output current overload. RMS current exceeded limit."	
Controller	497	"Fault"	"Emergency shutdown."	
Controller	498	"Fault"	"Exceeded under RMS voltage limit."	
Controller	499	"Fault"	"Exceeded over RMS voltage limit."	
Controller	500	"Fault"	"Constant power overvoltage."	
Controller	501	"Fault"	"Sensing fault."	
Controller	504	"Fault"	"Power module not connected."	

Source	Code	Type	Description	Possible cause
Controller	505	"Fault"	"Master disabled."	
Controller	506	"Fault"	"Two masters detected."	
Controller	507	"Fault"	"Power module shutdown."	
Controller	508	"Fault"	"Power module coupling mismatch."	
Controller	509	"Fault"	"Power module form mismatch."	
Controller	510	"Fault"	"Power module not detected."	
Controller	511	"Fault"	"Power module communication fault."	
Controller	512	"Fault"	"Power module local fault."	
Controller	513	"Fault"	"Power module over-voltage."	
Controller	514	"Fault"	"Power module under-voltage."	
Controller	515	"Fault"	"Power module temperature fault."	
Controller	516	"Fault"	"Power module pre-charge error."	
Controller	517	"Fault"	"Power module NTC fail."	
Controller	518	"Fault"	"Power module shutdown."	
Controller	519	"Fault"	"Power module no AC detected."	
Controller	520	"Fault"	"Forced fault."	
Controller	521	"Fault"	"Output current RMS exceeded limit."	
Controller	465	"Internal fault"	"Internal McBSP communication CRC error."	
Controller	466	"Internal fault"	"Internal sync error in CPU1."	
Controller	467	"Internal fault"	"Internal sync error in CPU2."	
Controller	468	"Internal fault"	"CPU1 invalid fault."	
Controller	469	"Internal fault"	"CPU2 invalid fault."	
Controller	482	"Internal fault"	"CLA task timeout."	
Controller	483	"Internal fault"	"Invalid node ID. Run unit discovery to recover."	
Controller	484	"Internal fault"	"Incorrect DSP type detected. Cycle-power to re-try."	
Controller	488	"Internal fault"	"Invalid constants loaded from EEPROM."	
Controller	502	"Internal fault"	"Firmware mismatch between CPUs."	
Controller	503	"Internal fault"	"Bootloader firmware mismatch between CPUs."	
Controller	519	"Internal fault"	"Controller is not in operational node."	
Controller	520	"Internal fault"	"Missing controller node."	
Controller	521	"Internal fault"	"Cannot read fault information."	

Table 12-1: Warnings and Error Messages Listing

## 13 Service and Maintenance

### 13.1 Warnings



## CAUTION

**THIS EQUIPMENT CONTAINS HIGH ENERGY, LOW IMPEDANCE CIRCUITS! LETHAL POTENTIALS ARE CONTAINED WITHIN THIS UNIT.**

**CARE MUST BE EXERCISED WHEN SERVICING THIS EQUIPMENT IN ORDER TO PREVENT SERIOUS SERVICE PERSONNEL INJURY OR EQUIPMENT DAMAGE.**

**OBSERVE THE FOLLOWING WHEN SERVICE OR MAINTENANCE ARE REQUIRED:**

- 1. REMOVE ALL JEWELRY FROM ARMS AND NECK WHEN SERVICING THIS EQUIPMENT. THIS PREVENTS THE POSSIBILITY OF SHORTING THROUGH THE JEWELRY AND CAUSING BURNS TO SERVICE PERSONNEL.**
- 2. WEAR SAFETY GLASSES WHEN SERVICING THIS EQUIPMENT TO PREVENT EYE INJURY DUE TO FLYING PARTICLES CAUSED BY ACCIDENTAL SHORT CIRCUIT CONDITIONS.**
- 3. DO NOT REMOVE ANY PANEL OR COVER WITHOUT FIRST REMOVING THE INPUT SERVICE BY OPENING ALL CIRCUIT BREAKERS.**
- 4. DO NOT REMOVE ANY PANEL OR COVER WITHOUT FIRST WAITING 20 MINUTES FOR ALL INTERNAL CHARGES TO DISSIPATE TO A SAFE LEVEL.**
- 5. SERVICE OTHER THAN EXTERNAL CLEANING SHOULD BE REFERRED TO PERSONNEL AUTHORIZED BY THE FACTORY TO SERVICE THIS EQUIPMENT.**



## CAUTION

**THIS EQUIPMENT CONTAINS HIGH ENERGY, LOW IMPEDANCE CIRCUITS! LETHAL POTENTIALS ARE CONTAINED WITHIN THIS UNIT.**

**CARE MUST BE EXERCISED WHEN SERVICING THIS EQUIPMENT IN ORDER TO PREVENT SERIOUS SERVICE PERSONNEL INJURY OR EQUIPMENT DAMAGE.**

**OBSERVE THE FOLLOWING WHEN SERVICE OR MAINTENANCE ARE REQUIRED:**

- 1. REMOVE ALL JEWELRY FROM ARMS AND NECK WHEN SERVICING THIS EQUIPMENT. THIS PREVENTS THE POSSIBILITY OF SHORTING THROUGH THE JEWELRY AND CAUSING BURNS TO SERVICE PERSONNEL.**
- 2. WEAR SAFETY GLASSES WHEN SERVICING THIS EQUIPMENT TO PREVENT EYE INJURY DUE TO FLYING PARTICLES CAUSED BY ACCIDENTAL SHORT CIRCUIT CONDITIONS.**
- 3. DO NOT REMOVE ANY PANEL OR COVER WITHOUT FIRST REMOVING THE INPUT SERVICE BY OPENING ALL CIRCUIT BREAKERS.**
- 4. DO NOT REMOVE ANY PANEL OR COVER WITHOUT FIRST WAITING 20 MINUTES FOR ALL INTERNAL CHARGES TO DISSIPATE TO A SAFE LEVEL.**
- 5. SERVICE OTHER THAN EXTERNAL CLEANING SHOULD BE REFERRED TO PERSONNEL AUTHORIZED BY THE FACTORY TO SERVICE THIS EQUIPMENT.**

## 13.2 Authorized Service Centers

There are **NO** end-user serviceable parts in this product. In case of a problem or malfunction, **DO NOT ATTEMPT TO REPAIR!** Instead, contact one of Pacific Power Source's authorized service centers or your local Pacific Power Source distributor. For a list of authorized service centers, refer to section 1, "Contact Information".



## 14 ModBus TCP Server / Slave Interface

### 14.1 ModBus TCP Interface

The ModBus TCP Server/Slave Interface provides a means to communicate with industrial bus protocols. This is a register based interface so no SCPI programming commands apply. Instead of sending commands, the user can write to specific register addresses to change various settings and read from other registers to option readings such as measurements or settings.

Gateway devices are available front third parties to connect to other bus protocols.

<https://www.anybus.com/products/gateway-index?Network-Interface-1=Modbus-TCP-Client/Master>

These gateways perform an intelligent protocol translation that allows devices and control systems using different protocols to communicate with each other seamlessly.

To use this interface, the user needs to reference the register addresses provided in the next section.

### 14.2 Modbus TCP Register Tables

The following tables apply to ADF, AFX, AZX, LMX and LSX Series power sources models. Some functions may not be supported on specific model series depending on supported modes of operation and feature sets.

Note: The information contained in the table below is available for download in MS Excel file [modbustcp-registers.xlsx](#) at the following link under 'documentation':

[https://github.com/PPST-Inc/ModbusTCP\\_Examples](https://github.com/PPST-Inc/ModbusTCP_Examples)

Modbus App

	Modbus address (dec)	Modbus address (hex)	Read coils	Read holding registers	Read input registers (0x06)	Write single coil (0x05)	Write single register (0x06)	Write multiple registers (0x10)	Description	Access	Data type	Data length in bytes	Number of registers	Data	Example
Modbus Interface	0	0000													
	1	0001			x				Modbus Ver	R	uint(16)	2	1		
	2	0002			x				Modbus Info	R	uint(16)	2	1		
Measurements	1000	03E8			x				Frequency	R	float	4	2	FP IEEE754	60
	1002	03EA			x				Output A frequency	R	float	4	2	FP IEEE754	
	1004	03EC			x				Output B frequency	R	float	4	2	FP IEEE754	
	1006	03EE			x				Output C frequency	R	float	4	2	FP IEEE754	
	1008	03F0			x				Voltage line to line ACDC	R	float	4	2	FP IEEE754	

Modbus App

Modbus address (dec)	Modbus address (hex)	Read coils	Read holding registers	Read input registers (0x06)	Write single coil (0x05)	Write single register (0x06)	Write multiple registers (0x10)	Description	Access	Data type	Data length in bytes	Number of registers	Data	Example
1010	03F2			x				Output A voltage line to line ACDC	R	float	4	2	FP IEEEE754	
1012	03F4			x				Output B voltage line to line ACDC	R	float	4	2	FP IEEEE754	
1014	03F6			x				Output C voltage line to line ACDC	R	float	4	2	FP IEEEE754	
1016	03F8			x				Voltage line to line AC	R	float	4	2	FP IEEEE754	
1018	03FA			x				Output A voltage line to line AC	R	float	4	2	FP IEEEE754	
1020	03FC			x				Output B voltage line to line AC	R	float	4	2	FP IEEEE754	
1022	03FE			x				Output C voltage line to line AC	R	float	4	2	FP IEEEE754	
1024	0400			x				Voltage line to line DC	R	float	4	2	FP IEEEE754	
1026	0402			x				Output A voltage line to line DC	R	float	4	2	FP IEEEE754	
1028	0404			x				Output B voltage line to line DC	R	float	4	2	FP IEEEE754	
1030	0406			x				Output C voltage line to line DC	R	float	4	2	FP IEEEE754	
1032	0408			x				Voltage ACDC	R	float	4	2	FP IEEEE754	
1034	040A			x				Output A voltage ACDC	R	float	4	2	FP IEEEE754	
1036	040C			x				Output B voltage ACDC	R	float	4	2	FP IEEEE754	
1038	040E			x				Output C voltage ACDC	R	float	4	2	FP IEEEE754	
1040	0410			x				Voltage AC	R	float	4	2	FP IEEEE754	
1042	0412			x				Output A voltage AC	R	float	4	2	FP IEEEE754	
1044	0414			x				Output B voltage AC	R	float	4	2	FP IEEEE754	
1046	0416			x				Output C voltage AC	R	float	4	2	FP IEEEE754	

Modbus App

Modbus address (dec)	Modbus address (hex)	Read coils	Read holding registers	Read input registers (0x06)	Write single coil (0x05)	Write single register (0x06)	Write multiple registers (0x10)	Description	Access	Data type	Data length in bytes	Number of registers	Data	Example
1048	0418			x				Voltage DC	R	float	4	2	FP IEEE754	
1050	041A			x				Output A voltage DC	R	float	4	2	FP IEEE754	
1052	041C			x				Output B voltage DC	R	float	4	2	FP IEEE754	
1054	041E			x				Output C voltage DC	R	float	4	2	FP IEEE754	
1056	0420			x				Current ACDC	R	float	4	2	FP IEEE754	
1058	0422			x				Output A current ACDC	R	float	4	2	FP IEEE754	
1060	0424			x				Output B current ACDC	R	float	4	2	FP IEEE754	
1062	0426			x				Output C current ACDC	R	float	4	2	FP IEEE754	
1064	0428			x				Current DC	R	float	4	2	FP IEEE754	
1066	042A			x				Output A current DC	R	float	4	2	FP IEEE754	
1068	042C			x				Output B current DC	R	float	4	2	FP IEEE754	
1070	042E			x				Output C current DC	R	float	4	2	FP IEEE754	
1072	0430			x				Active power	R	float	4	2	FP IEEE754	
1074	0432			x				Output A active power	R	float	4	2	FP IEEE754	
1076	0434			x				Output B active power	R	float	4	2	FP IEEE754	
1078	0436			x				Output C active power	R	float	4	2	FP IEEE754	
1080	0438			x				Apparent power	R	float	4	2	FP IEEE754	
1082	043A			x				Output A apparent power	R	float	4	2	FP IEEE754	
1084	043C			x				Output B apparent power	R	float	4	2	FP IEEE754	
1086	043E			x				Output C apparent power	R	float	4	2	FP IEEE754	
1088	0440			x				Peak current	R	float	4	2	FP IEEE754	
1090	0442			x				Output A peak current	R	float	4	2	FP IEEE754	
1092	0444			x				Output B peak current	R	float	4	2	FP IEEE754	

Modbus App

Modbus address (dec)	Modbus address (hex)	Read coils	Read holding registers	Read input registers (0x06)	Write single coil (0x05)	Write single register (0x06)	Write multiple registers (0x10)	Description	Access	Data type	Data length in bytes	Number of registers	Data	Example
1094	0446			x				Output C peak current	R	float	4	2	FP IEEE754	
1096	0448			x				Power factor	R	float	4	2	FP IEEE754	
1098	044A			x				Output A power factor	R	float	4	2	FP IEEE754	
1100	044C			x				Output B power factor	R	float	4	2	FP IEEE754	
1102	044E			x				Output C power factor	R	float	4	2	FP IEEE754	
1104	0450			x				Crest factor	R	float	4	2	FP IEEE754	
1106	0452			x				Output A crest factor	R	float	4	2	FP IEEE754	
1108	0454			x				Output B crest factor	R	float	4	2	FP IEEE754	
1110	0456			x				Output C crest factor	R	float	4	2	FP IEEE754	
1112	0458			x				Peak current recorded	R	float	4	2	FP IEEE754	
1114	045A			x				Output A peak current recorded	R	float	4	2	FP IEEE754	
1116	045C			x				Output B peak current recorded	R	float	4	2	FP IEEE754	
1118	045E			x				Output C peak current recorded	R	float	4	2	FP IEEE754	
1120	0460			x				Voltage thd	R	float	4	2	FP IEEE754	
1122	0462			x				Output A voltage thd	R	float	4	2	FP IEEE754	
1124	0464			x				Output B voltage thd	R	float	4	2	FP IEEE754	
1126	0466			x				Output C voltage thd	R	float	4	2	FP IEEE754	
1128	0468			x				Current thd	R	float	4	2	FP IEEE754	
1130	046A			x				Output A current thd	R	float	4	2	FP IEEE754	
1132	046C			x				Output B current thd	R	float	4	2	FP IEEE754	
1134	046E			x				Output C current thd	R	float	4	2	FP IEEE754	
1136	0470			x				Power factor angle	R	float	4	2	FP IEEE754	

Modbus App

Modbus address (dec)	Modbus address (hex)	Read coils	Read holding registers	Read input registers (0x06)	Write single coil (0x05)	Write single register (0x06)	Write multiple registers (0x10)	Description	Access	Data type	Data length in bytes	Number of registers	Data	Example
1138	0472			x				Output A power factor angle	R	float	4	2	FP IEEE754	
1140	0474			x				Output B power factor angle	R	float	4	2	FP IEEE754	
1142	0476			x				Output C power factor angle	R	float	4	2	FP IEEE754	
1144	0478			x				Displacement factor	R	float	4	2	FP IEEE754	
1146	047A			x				Output A displacement factor	R	float	4	2	FP IEEE754	
1148	047C			x				Output B displacement factor	R	float	4	2	FP IEEE754	
1150	047E			x				Output C displacement factor	R	float	4	2	FP IEEE754	
1152	0480			x				Distortion factor	R	float	4	2	FP IEEE754	
1154	0482			x				Output A distortion factor	R	float	4	2	FP IEEE754	
1156	0484			x				Output B distortion factor	R	float	4	2	FP IEEE754	
1158	0486			x				Output C distortion factor	R	float	4	2	FP IEEE754	
1160	0488			x				Kilowatt hour	R	float	4	2	FP IEEE754	
1162	048A			x				Output A kilowatt hour	R	float	4	2	FP IEEE754	
1164	048C			x				Output B kilowatt hour	R	float	4	2	FP IEEE754	
1166	048E			x				Output C kilowatt hour	R	float	4	2	FP IEEE754	
1168	0490			x				Kilowatt hour elapsed time	R	float	4	2	FP IEEE754	
1170	0492			x				Output A kilowatt hour elapsed time	R	float	4	2	FP IEEE754	
1172	0494			x				Output B kilowatt hour elapsed time	R	float	4	2	FP IEEE754	

Modbus App

Modbus address (dec)	Modbus address (hex)	Read coils	Read holding registers	Read input registers (0x06)	Write single coil (0x05)	Write single register (0x06)	Write multiple registers (0x10)	Description	Access	Data type	Data length in bytes	Number of registers	Data	Example
1174	0496			x				Output C kilowatt hour elapsed time	R	float	4	2	FP IEEE754	
2800	0AF0	x			x			Reset KWH	RW	bool			Coils : Kreset	ON=reset , self clear
2801	0AF1	x			x			Enable KWH	RW	bool			Coils : Kwhenable	ON=enable, OFF=disable

Setpoints	Modbus address (dec)	Modbus address (hex)	Read coils	Read holding registers	Read input registers (0x06)	Write single coil (0x05)	Write single register (0x06)	Write multiple registers (0x10)	Description	Access	Data type	Data length in bytes	Number of registers	Data	Example
	3000	0BB8							Program frequency	RW	float	4	2	FP IEEE754	
Program	3002	0BBA							Program frequency A	RW	float	4	2	FP IEEE754	
	3004	0BBC							Program frequency B	RW	float	4	2	FP IEEE754	
	3006	0BBE							Program frequency C	RW	float	4	2	FP IEEE754	
	3008	0BC0							Program voltage AC	RW	float	4	2	FP IEEE754	Value=VALUE if all set, Value=0 if else
	3010	0BC2							Program voltage AC output A	RW	float	4	2	FP IEEE754	
	3012	0BC4							Program voltage AC output B	RW	float	4	2	FP IEEE754	
	3014	0BC6							Program voltage AC output C	RW	float	4	2	FP IEEE754	
	3016	0BC8							Program voltage DC	RW	float	4	2	FP IEEE754	Value=VALUE if all set, Value=0 if else
	3018	0BCA							Program voltage DC output A	RW	float	4	2	FP IEEE754	
	3020	0BCC							Program voltage DC output B	RW	float	4	2	FP IEEE754	

Modbus App

Modbus address (dec)	Modbus address (hex)	Read coils	Read holding registers	Read input registers (0x06)	Write single coil (0x05)	Write single register (0x06)	Write multiple registers (0x10)	Description	Access	Data type	Data length in bytes	Number of registers	Data	Example
3022	0BCE							Program voltage DC output C	RW	float	4	2	FP IEEE754	
3024	0BD0							Power limit	RW	float	4	2	FP IEEE754	Value=V ALUE if all set, Value=0 if else
3026	0BD2							Power limit output A	RW	float	4	2	FP IEEE754	
3028	0BD4							Power limit output B	RW	float	4	2	FP IEEE754	
3030	0BD6							Power limit output C	RW	float	4	2	FP IEEE754	
3032	0BD8							Current limit ABC	RW	float	4	2	FP IEEE754	Value=V ALUE if all set, Value=0 if else
3034	0BDA							Current limit output A	RW	float	4	2	FP IEEE754	
3036	0BDC							Current limit output B	RW	float	4	2	FP IEEE754	
3038	0BDE							Current limit output C	RW	float	4	2	FP IEEE754	
3040	0BE0							KVA Limit	RW	float	4	2	FP IEEE754	Value=V ALUE if all set, Value=0 if else
3042	0BE2							KVA Limit output A	RW	float	4	2	FP IEEE754	
3044	0BE4							KVA Limit output B	RW	float	4	2	FP IEEE754	
3046	0BE6							KVA Limit output C	RW	float	4	2	FP IEEE754	
3048	0BE8							Phase offset output B	RW	float	4	2	FP IEEE754	
3050	0BEA							Phase offset output C	RW	float	4	2	FP IEEE754	
4000	0FA0	x			x			Enable output	RW	bool			Coils: Output	ON=enab le, OFF=disa ble
4001	0FA1	x			x			Enable output A	RW	bool			Coils: Output	ON=enab le,

Modbus App

Modbus address (dec)	Modbus address (hex)	Read coils	Read holding registers	Read input registers (0x06)	Write single coil (0x05)	Write single register (0x06)	Write multiple registers (0x10)	Description	Access	Data type	Data length in bytes	Number of registers	Data	Example
														OFF=disable
4002	0FA2	x			x			Enable output B	RW	bool			Coils: Output	ON=enable, OFF=disable
4003	0FA3	x			x			Enable output C	RW	bool			Coils: Output	ON=enable, OFF=disable

5000	1388	x			x			RMS Current protection	RW	bool				
5001	1389	x			x			Output A RMS Current protection	RW	bool				
5002	138A	x			x			Output B RMS Current protection	RW	bool				
5003	138B	x			x			Output C RMS Current protection	RW	bool				
5004	138C	x			x			RMS Power protection	RW	bool				
5005	138D	x			x			Output A RMS Power protection	RW	bool				
5006	138E	x			x			Output B RMS Power protection	RW	bool				
5007	138F	x			x			Output C RMS Power protection	RW	bool				
5008	1390	x			x			Peak current protection	RW	bool				
5009	1391	x			x			Output A Peak current protection	RW	bool				
5010	1392	x			x			Output B Peak current protection	RW	bool				
5011	1393	x			x			Output C Peak current protection	RW	bool				



Modbus App

Modbus address (dec)	Modbus address (hex)	Read coils	Read holding registers	Read input registers (0x06)	Write single coil (0x05)	Write single register (0x06)	Write multiple registers (0x10)	Description	Access	Data type	Data length in bytes	Number of registers	Data	Example
5012	1394	x			x			Peak voltage protection	RW	bool				
5013	1395	x			x			Output A Peak voltage protection	RW	bool				
5014	1396	x			x			Output B Peak voltage protection	RW	bool				
5015	1397	x			x			Output C Peak voltage protection	RW	bool				
5024	13A0							Current level	RW	float	4	2	FP IEEE754	
5026	13A2							Output A Current level	RW	float	4	2	FP IEEE754	
5028	13A4							Output B Current level	RW	float	4	2	FP IEEE754	
5030	13A6							Output C Current level	RW	float	4	2	FP IEEE754	
5032	13A8							Power level	RW	float	4	2	FP IEEE754	
5034	13AA							Output A Power level	RW	float	4	2	FP IEEE754	
5036	13AC							Output B Power level	RW	float	4	2	FP IEEE754	
5038	13AE							Output C Power level	RW	float	4	2	FP IEEE754	
5040	13B0							KVA Level	RW	float	4	2	FP IEEE754	
5042	13B2							Output A KVA Level	RW	float	4	2	FP IEEE754	
5044	13B4							Output B KVA Level	RW	float	4	2	FP IEEE754	
5046	13B6							Output C KVA Level	RW	float	4	2	FP IEEE754	
5048	13B8							Trip time	RW	float	4	2	FP IEEE754	minimum step of 0.1 seconds
5050	13BA							Output A Trip time	RW	float	4	2	FP IEEE754	
5052	13BC							Output B Trip time	RW	float	4	2	FP IEEE754	
5054	13BE							Output C Trip time	RW	float	4	2	FP IEEE754	
5056	13C0							Peak current limit	RW	float	4	2	FP IEEE754	

Modbus App

Modbus address (dec)	Modbus address (hex)	Read coils	Read holding registers	Read input registers (0x06)	Write single coil (0x05)	Write single register (0x06)	Write multiple registers (0x10)	Description	Access	Data type	Data length in bytes	Number of registers	Data	Example
5058	13C2							Output A Peak current limit	RW	float	4	2	FP IEEE754	
5060	13C4							Output B Peak current limit	RW	float	4	2	FP IEEE754	
5062	13C6							Output C Peak current limit	RW	float	4	2	FP IEEE754	
5064	13C8							Peak current protection level	RW	float	4	2	FP IEEE754	
5066	13CA							Output A Peak current protection level	RW	float	4	2	FP IEEE754	
5068	13CC							Output B Peak current protection level	RW	float	4	2	FP IEEE754	
5070	13CE							Output C Peak current protection level	RW	float	4	2	FP IEEE754	
5072	13D0							Peak voltage protection margin	RW	float	4	2	FP IEEE754	
5074	13D2							Output A Peak voltage protection margin	RW	float	4	2	FP IEEE754	
5076	13D4							Output B Peak voltage protection margin	RW	float	4	2	FP IEEE754	
5078	13D6							Output C Peak voltage protection margin	RW	float	4	2	FP IEEE754	
5080	13D8							Peak voltage protection level	RW	float	4	2	FP IEEE754	
5082	13DA							Output A Peak voltage protection level	RW	float	4	2	FP IEEE754	

Modbus App

Modbus address (dec)	Modbus address (hex)	Read coils	Read holding registers	Read input registers (0x06)	Write single coil (0x05)	Write single register (0x06)	Write multiple registers (0x10)	Description	Access	Data type	Data length in bytes	Number of registers	Data	Example
5084	13DC							Output B Peak voltage protection level	RW	float	4	2	FP IEEE754	
5086	13DE							Output C Peak voltage protection level	RW	float	4	2	FP IEEE754	
5088	13E0							Peak voltage protection mode	RW	uint(16)	2	1	unsgnd int 16b	0=MARGIN, 1=LEVEL, 2=MARGIN &LEVEL
5090	13E2							Output A Peak voltage protection mode	RW	uint(16)	2	1	unsgnd int 16b	
5092	13E4							Output B Peak voltage protection mode	RW	uint(16)	2	1	unsgnd int 16b	
5094	13E6							Output C Peak voltage protection mode	RW	uint(16)	2	1	unsgnd int 16b	

Configuration	6000	1770						Ramp time	RW	float	4	2	FP IEEE754	0.222 Seconds
Slew	6002	1772						Output A Ramp time	RW	float	4	2	FP IEEE754	
	6004	1774						Output B Ramp time	RW	float	4	2	FP IEEE754	
	6006	1776						Output C Ramp time	RW	float	4	2	FP IEEE754	
	6008	1778						Voltage AC	RW	float	4	2	FP IEEE754	
	6010	177A						Output A Voltage AC	RW	float	4	2	FP IEEE754	
	6012	177C						Output B Voltage AC	RW	float	4	2	FP IEEE754	
	6014	177E						Output C Voltage AC	RW	float	4	2	FP IEEE754	
	6016	1780						Frequency	RW	float	4	2	FP IEEE754	
	6018	1782						Output A Frequency	RW	float	4	2	FP IEEE754	

Modbus App

Modbus address (dec)	Modbus address (hex)	Read coils	Read holding registers	Read input registers (0x06)	Write single coil (0x05)	Write single register (0x06)	Write multiple registers (0x10)	Description	Access	Data type	Data length in bytes	Number of registers	Data	Example
6020	1784							Output B Frequency	RW	float	4	2	FP IEEE754	
6022	1786							Output C Frequency	RW	float	4	2	FP IEEE754	
6024	1788							Voltage DC	RW	float	4	2	FP IEEE754	
6026	178A							Output A Voltage DC	RW	float	4	2	FP IEEE754	
6028	178C							Output B Voltage DC	RW	float	4	2	FP IEEE754	
6030	178E							Output C Voltage DC	RW	float	4	2	FP IEEE754	
6032	1790							Phase	RW	float	4	2	FP IEEE754	
6034	1792							Output A Phase	RW	float	4	2	FP IEEE754	
6036	1794							Output B Phase	RW	float	4	2	FP IEEE754	
6038	1796							Output C Phase	RW	float	4	2	FP IEEE754	
6040	1798				x			Slew rate control	RW	bool				
6041	1799				x			Output A Slew rate control	RW	bool				
6042	179A				x			Output B Slew rate control	RW	bool				
6043	179B				x			Output C Slew rate control	RW	bool				

Configuration	8000	1F40						Configuration form	RW	uint(16)	2	1	unsgnd int 16b	1=SINGLE, 2=SPLIT, 3=THREE
Unit	8001	1F41						Configuration voltage range	RW	uint(16)	2	1	unsgnd int 16b	0=LOW, 1=HIGH
Settings	8002	1F42						Configuration mode	RW	uint(16)	2	1	unsgnd int 16b	0=AC, 1=DC, 2=AC-DC
	8003	1F43						Phase rotation	RW	uint(16)	2	1	unsgnd int 16b	0=NEGATIVE, 1=POSITIVE
	8004	1F44						Output impedance mode	RW	uint(16)	2	1	unsgnd int 16b	0=REAL TIME, 1=RMS

Modbus App

Modbus address (dec)	Modbus address (hex)	Read coils	Read holding registers	Read input registers (0x06)	Write single coil (0x05)	Write single register (0x06)	Write multiple registers (0x10)	Description	Access	Data type	Data length in bytes	Number of registers	Data	Example
8005	1F45							Output A impedance mode	RW	uint(16)	2	1	unsngnd int 16b	
8006	1F46							Output B impedance mode	RW	uint(16)	2	1	unsngnd int 16b	
8007	1F47							Output C impedance mode	RW	uint(16)	2	1	unsngnd int 16b	
8016	1F50							Update phase	RW	float	4	2	FP IEEE754	
8018	1F52							Output A update phase	RW	float	4	2	FP IEEE754	
8020	1F54							Output B update phase	RW	float	4	2	FP IEEE754	
8022	1F56							Output C update phase	RW	float	4	2	FP IEEE754	
8024	1F58							Output phase disable	RW	float	4	2	FP IEEE754	
8026	1F5A							Output A phase disable	RW	float	4	2	FP IEEE754	
8028	1F5C							Output B phase disable	RW	float	4	2	FP IEEE754	
8030	1F5E							Output C phase disable	RW	float	4	2	FP IEEE754	
8032	1F60							Max CSC gain	RW	float	4	2	FP IEEE754	
8034	1F62							Output A max CSC gain	RW	float	4	2	FP IEEE754	
8036	1F64							Output B max CSC gain	RW	float	4	2	FP IEEE754	
8038	1F66							Output C max CSC gain	RW	float	4	2	FP IEEE754	
8048	1F70	x			x			Continuous self calibration	RW	bool				
8049	1F71	x			x			Output A continuous self calibration	RW	bool				
8050	1F72	x			x			Output B continuous self calibration	RW	bool				
8051	1F73	x			x			Output C continuous	RW	bool				

Modbus App

Modbus address (dec)	Modbus address (hex)	Read coils	Read holding registers	Read input registers (0x06)	Write single coil (0x05)	Write single register (0x06)	Write multiple registers (0x10)	Description	Access	Data type	Data length in bytes	Number of registers	Data	Example
								self calibration						
8052	1F74	x			x			Fault on saturation	RW	bool				
8053	1F75	x			x			Output A fault on saturation	RW	bool				
8054	1F76	x			x			Output B fault on saturation	RW	bool				
8055	1F77	x			x			Output C fault on saturation	RW	bool				

6400	FA00							SCPI Write/query	RW	char	246	123	ASCII	MEASure : VOLTage : DC:NC#?
6426	FB00							SCPI Command last answer			1024	512	ASCII	0.000,0 .000 0.000,0 .000
6479	FD01	x			x			SCPI Char 16 endianess	RW	bool			Coils : Endianess	OFF= little, ON= Inverted
6470	FD02	x			x			SCPI Response next page	RW	bool			Coils : Next Page	ON=next, self clear

### 14.3 ModBus Control Example using Python

For those not familiar with using the ModBus TCP protocols, the example code shown here using Python may be of assistance in getting started.

Note: The example code named “modbustcp-example-1.py” referenced below is available for download at the following link in the ‘python’ directory:

[https://github.com/PPST-Inc/ModbusTCP\\_Examples](https://github.com/PPST-Inc/ModbusTCP_Examples)

This example code performs the following tasks in the order shown below.

```
> python.exe modbustcp-example-1.py
Enter the IP address of the unit: 192.168.107.183
Connecting
Setting voltage AC to 0 Vrms
Setting frequency to 50 Hz
Turning output on...
Setting voltage AC to 30 Vrms
Reading RMS voltage measurement
Voltage RMS measurement: 29.93 Vrms
Reading RMS current measurement
Current RMS measurement: 2.74 Arms
Turning output off
Disconnecting
Done
```

The dependencies and requirements to run the sample code are shown in the program comments and are:

```
# PPST ModbusTCP python example 1
# Version: 1.0.0
# Date: 11/07/2022
# Dependences:
# - pip install pymodbus
# - pip install pyModbusTCP
# Last tested with:
# - Python 3.10.5
# - pymodbus 3.0.2
# - pyModbusTCP 0.2.0
```

More advanced samples can be found using the link referenced above.

## 15 CE MARK Declaration of Conformity

The Manufacturer hereby declares that the products:

**Product Name:** LSX Series® AC Power Sources, All Models in Series

Conforms to the following standards or other normative documents:

**RoHS (DIRECTIVE 2011/65/EU)**

Standard applied EN 50581:2012

**SAFETY (DIRECTIVE 2014/35/EC):**

Standard applied EN 61010–1: 2010; ED3/A1:2019

**EMC (DIRECTIVE 2014/30/EU):**

Standard applied EN 61326-1: 2013

**Reference Standards:**

**ELECTROMAGNETIC EMISSIONS:**

Radiated Emissions CISPR 11/22, CLASS A LIMITS  
Conducted Emissions CISPR 11/22, CLASS A LIMITS

**ELECTROMAGNETIC IMMUNITY:**

RF Electromagnetic Field IEC 61000-4-3:2006+A1:2007+A2:2010  
80 – 1000 MHz, 10 V/m  
1 Khz sinewave (80% AM) 1.4 – 2 GHz, 3 V/m  
2.0 – 2.7 GHz, 1 V/m

Conducted RF Immunity IEC 61000-4-6:2013  
Conducted RF Immunity 0.15 – 80 MHz @ 3 Vrms

Electrostatic Discharge IEC 61000-4-2:2008  
± 4 kV contact discharge  
± 8 kV air discharge

Electrical Fast Transient/Burst IEC 61000-4-4:2004+A1:2010  
AC or DC power ports, ± 2.0 kV  
Signal and I/O ports, ± 1.0 kV

Surge IEC 61000-4-5:2006  
AC or DC power ports, ± 2.0 kV Line to ground and ± 1.0 kV Line to Line

Power Frequency Magnetic Field IEC 61000-4-8:2009  
30 A/m

**Supplemental Information:**

**When and Where Issued** March 15, 2023  
Irvine, California, USA

**Authorized Signatory**   
Mitchel Orr,  
Quality Manager, acting  
Pacific Power Source

**Responsible Person** Joe Abranko,  
Pacific Power Source, Inc.  
2802 Kelvin Ave, Suite 100  
Irvine CA, 92614

Mark of Compliance





## Index

<b>A</b>		<b>I</b>	
AC Input .....	45, 59	Import	
accessories		Transient List .....	416
included .....	26	Installation .....	16, 57, 399
Accessories .....	26	Interface	
air filter .....	73	Ethernet .....	94
<b>B</b>		Ethernet Browser .....	401
Browser .....	401	GPIB Settings .....	170
Remote Interface .....	461	I/O Settings .....	170
<b>C</b>		LAN94	
Calibration .....	469	Monitor .....	97
Commands .....	212	Remote Inhibit Settings .....	171
CE MARK .....	520	RS232 Settings .....	168
Circuit Breaker .....	72	Screens .....	161
CONFIGURATION		USB Settings .....	169
Screens .....	136	<b>K</b>	
Configuration Settings .....	138	Keyboard .....	96
Console		Touchscreen .....	164
SCPI .....	174	<b>L</b>	
Contact .....	15, 92, 504	LAN	
Contents .....	3	Access Control .....	403
CSC Configuration .....	146	Browser Interface .....	401
CSV files		Configuration .....	401
Transient List Import/Export .....	416	Setup .....	167
Cycle Reset .....	154	LAN Configuration .....	401
<b>D</b>		LAN .....	94
Date formats .....	360	LCD Image	
Decimal separator .....	360	capture to image file .....	96
Deviation		Logging measurement data .....	119
Web Browser .....	423	LSXM version .....	24
<b>E</b>		<b>M</b>	
equipment weight .....	57	M version models .....	24
Error and Event queue .....	160	Maintenance	
Error Messages .....	478	Air Filter Cleaning .....	73
Ethernet .....	94	Managing	
Access Control .....	403	Files177	
Export Option .....	40	Manual .....	411
External Sync Output .....	194	Measurement Command	
<b>F</b>		Resolution Setting .....	231
Fault Queue .....	160	Measurements	
Features .....	25	Datalogger .....	117
File Manager .....	177	MEASUREMENTS	
Filter		Logging .....	183
Air Intake .....	73	Screen .....	114
Firmware Update .....	182	Soft Keys .....	117
front panel operation .....	95	Memory	
		SD Card .....	97
		USB97	
		Memory Management .....	176
		Menus .....	98
		ModBus	

TCP.....	505	LCD Image.....	464
<b>O</b>		SD Card.....	97
optional output transformer.....	139	Service.....	503
<b>Options</b>		Shuttle.....	96
Export.....	40	Slew Rates.....	143
<b>Output</b>		Specifications.....	27
Enable Button.....	96	Start Phase.....	138
Impedance.....	155	Stop Phase.....	138
Response Time.....	98	<b>SYSTEM</b>	
Output Enable.....	98	Screens.....	158
Output Impedance.....	155	<b>T</b>	
<b>P</b>		T Option.....	139
Phase Angle		Terminator Characters.....	210
Control.....	138	Test Sequences	
phase rotation		Browser Interface.....	433
positive or negative.....	140	SCPI Commands.....	387
Phase rotation.....	102	Touchscreen Keyboard.....	164
Powering Up.....	92	Transformer	
Presets		Option.....	341
Output Parameters.....	103	Transient Settings.....	147
Program		<b>TRANSIENTS</b>	
Impedance.....	155	Screens.....	120
<b>PROGRAM</b>		Turn on.....	92
Soft Keys.....	105	<b>U</b>	
<b>PROGRAM &amp; MEASUREMENTS</b>		UNIT INFORMATION.....	172
Screen.....	99	unpacking.....	57
Program Data Entry.....	103	UPC Controller	
Program Memory.....	145	toggle switch.....	235
Programming.....	95, 209	Update Phase.....	138
Conventions.....	209	<b>USB</b>	
Terminators.....	210	Drivers.....	399
Protection.....	43	USB93	
<b>R</b>		User Limits.....	142
Regional setting.....	360	User Presets.....	156
Remote Control.....	209	<b>V</b>	
RS232		Video Monitor.....	97
Interface.....	168	Virtual Front Panel	
<b>S</b>		Browser.....	461
safety information.....	16	<b>W</b>	
Safety Information.....	16	Warranty.....	16
Safety Notices.....	18	Waveform	
SCIP Console.....	174	Library.....	109
Screen capture		Weight.....	48







# **Pacific Power Source**

The Power of Expertise