

Introducing the GSZ Series

The Industry's Most Flexible, Comprehensive, and Intelligent Regenerative Grid Simulator, Optional Load, with PHIL



Regenerative



PHIL Interface Option

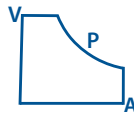

Constant Power



High Current

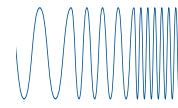

Wide Frequency Range

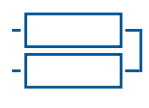

Scalable Power

Key Features

- Regenerative Grid Simulator
 - » 4-Quadrant AC & DC Power Source
 - » AC/DC Electronic Load Option
- Available Models 30kW, 45kW & 55kW; Parallel up to 440kW
- Three Phase, Split Phase and Single Phase Output Modes
- AC, DC, AC+DC or DC+AC Output Capability
- Dual Constant Power Mode Voltage Ranges
 - » AC Voltage Ranges: 0~225Vac and 0~440Vac
 - » DC Voltage Ranges: 0~335Vdc and 0~650Vdc
- Frequency Range 15 - 200Hz
- Wide Range Programmable R and L Impedance
- Phase Angle Programming
- Galvanic Isolation from Facility AC Input to Output and Between Output Phases / Channels
- Dynamic, Quiet, Efficient Operation Using Silicon Carbide (SiC)
- High AC Current Range
- High Speed Waveform Capture and Scope Display
- Powerful Line Disturbance Tools
 - » Generate Harmonics and Interharmonics
- **SmartSource Suite** Web Browser Control
- IEC61000-4-13 Inter-Harmonics Test
- High Speed Analog I/O for PHIL Mode (Option H)

GSZ Series

Regenerative Grid Simulator and Load

The GSZ Series is a Regenerative AC/DC power source that can function as a grid simulator, electronic load, and PHIL interface for power hardware-in-the-loop applications. Its wide operating range in power, voltage, and current is available in 30kW, 45kW, and 55kW models. Parallel cabinets up to 440kW.

This comprehensive platform is optimized for PHIL, has three powerful DSPs to cover advanced applications, and eliminates the need for add-on equipment. It has highly versatile channel outputs for different dynamic applications, and advanced control and programming capabilities.

The wide selection of power, frequency, and phase angle modes allow you to test a broad range of grid-tied products in the renewable energy, electric vehicle charging and industrial markets. Easily test the UUT to regulatory compliance standards.

Application Examples:

- EV Charging, On Board Chargers (OBC), Wallboxes, V2G, V2H, V2X, and EV Charging Cables
- Solar PV/Grid-Tied Inverters
- Closed Loop PHIL Micro-Grid Simulation
- Energy Storage Systems (ESS), Home ESS
- Renewable Energy Smart-Grid Simulation
- EMC Compliance Testing



Flexible Control

Dual Constant Power Voltage & Current Ranges

The GSZ series supports both low and high voltage ranges for either AC or DC mode. In AC mode, constant power is available from 52% of full scale voltage to 100% of full scale voltage as shown in Figure 1 & 3 below.

This allows higher currents to or from the UUT at lower than full scale voltage than would otherwise be possible. For voltage settings below 52% of full scale, current remains at max. rated current.

On 3550GSZ models, the 440Vac range supports 75A at 244Vac for load currents with a crest factor below 1.8. This supports Harmonics & Flicker testing to the max. required current per IEC61000-3-11 & IEC61000-3-12.

In DC mode, constant power is available from 50% of full scale voltage to 100% of full scale as shown in Figure 2 & 4 below.

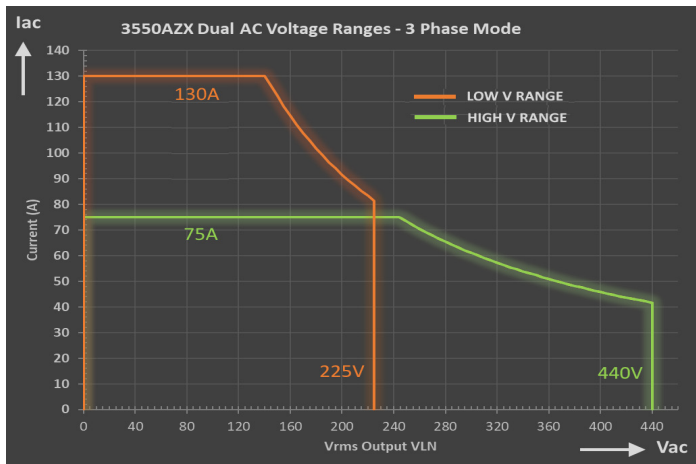

Figure 1: High and Low AC Voltage Ranges - Current vs. Voltage - 55kW

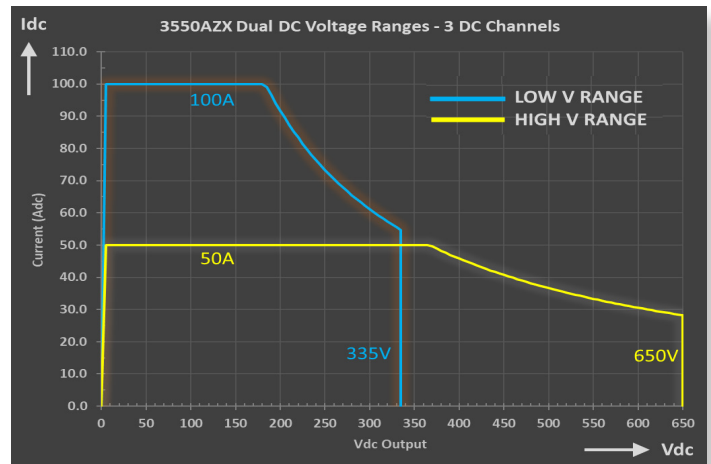

Figure 2: High and Low DC Voltage Ranges - Current vs. Voltage - 55kW

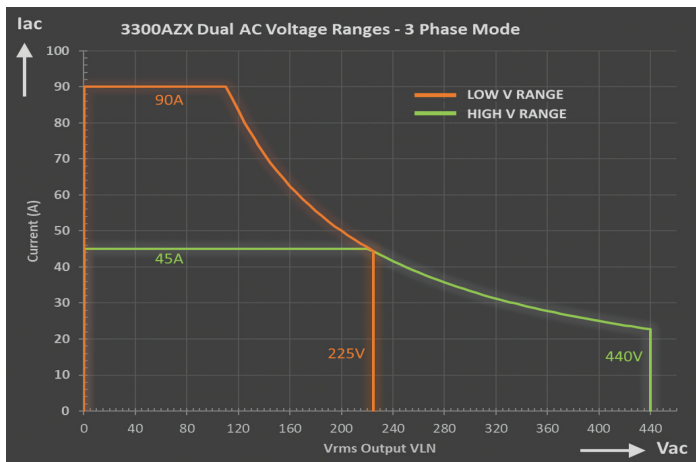

Figure 3: High and Low AC Voltage Ranges - Current vs. Voltage - 30kW

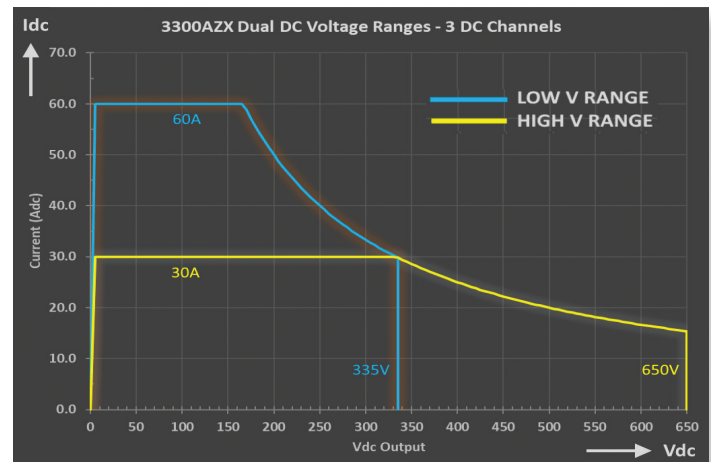
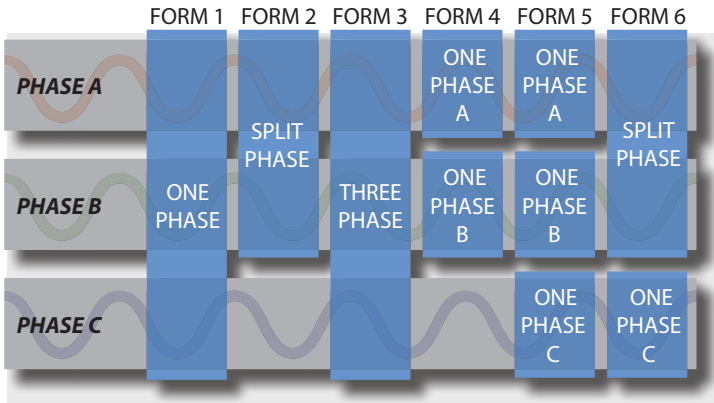

Figure 4: High and Low DC Voltage Ranges - Current vs. Voltage - 30kW

Ultimate Flexibility With Six Output Configurations



Simultaneous AC & DC Operation on Individual Phases and Automatic Switching of Operation Modes

In addition to the conventional single, split and three phase output modes, the GSZ also supports fully independent output modes for either 2 or 3 'channels'. In these modes, each channel can be set to have a different operation mode (Voltage Source, Current Source or Load) and frequency (for AC). Specify option "W" to have the factory disconnect the three neutral terminals shorting bar to support 3 fully isolated channels.

Power HIL Support (Option H)

To support integrated test system design, the GSZ Series offers a standard suite of analog and digital I/O functions. The user can assign command macros or setting parameters to analog or digital I/O pins as needed. This provides a unique level of customization for putting together sophisticated test stations.

By adding the H Option, the GSZ can be used as an amplifier for PHIL Applications. This analog interface provides high speed input for controlling frequency, voltage or current and waveshape. Amplifier latency is typically less than 50 usec. Voltage and Current output capture signals are returned to the simulation system. These analog I/O lines can be connected to commercially available HIL systems.

PHIL Simulation Workflow

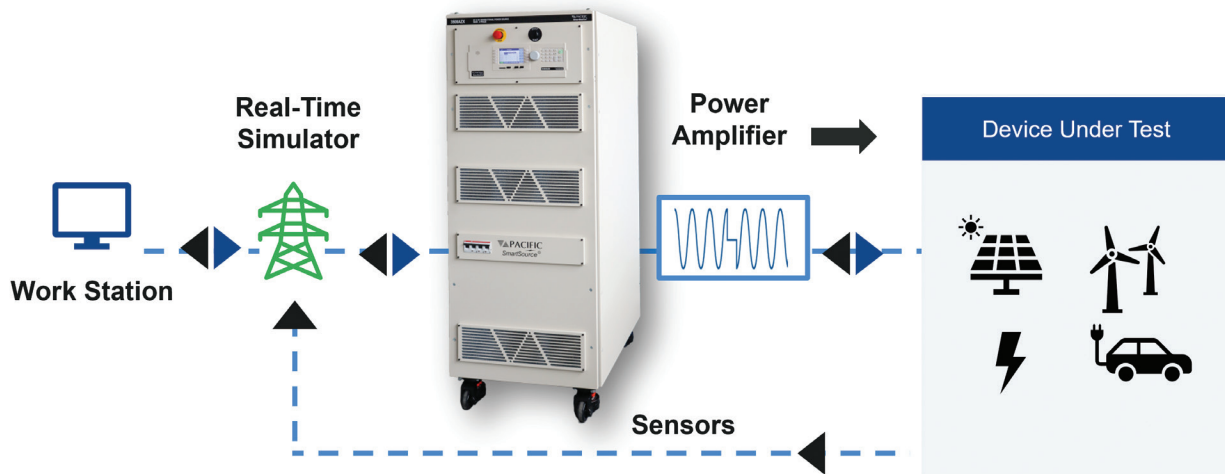

Regenerative Power Saves Significant Energy and Costs

Regenerative AC & DC power sources provide energy efficiency and significant cost savings by returning energy back to the facility or the grid. The GSZ produces less heat, ensures a stable testing environment for reliability reducing the need for additional cooling systems. Regenerative bidirectional power flows are critical for simulating real-world conditions in transportation and renewable energy systems.

Powerful Waveform & Measurement Tools

The GSZ has a built-in waveform digitizer and fast transient capabilities at 100 μ sec time resolution, supporting LIST, PULSE and STEP modes. Waveform generation includes ten Standard, Sine, Square, Triangle, Clipped, Harmonics and Inter-harmonics.

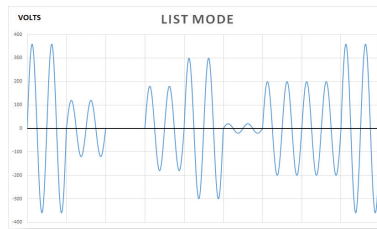

List Mode

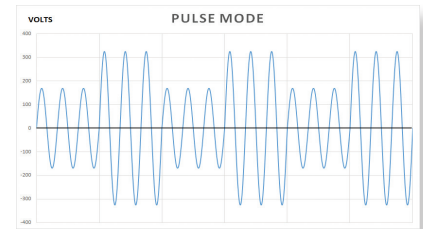

Pulse Mode

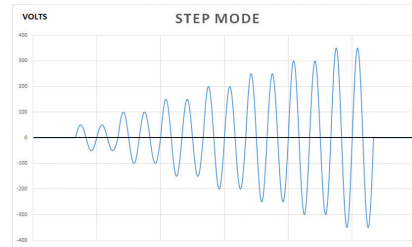

Step Mode

The waveform digitizer is complemented by a digital measurement system with scope function. Capture advanced measurements and waveforms.

Fully Test AC Power with 4-Quadrant Load (Option L)

Optional load feature also supports testing PV inverters, V2G, EV Chargers, EVSE, batteries, UPS, and AC/DC power supplies. A key advantage of the GSZ Regenerative Load Option is its ability to operate in all four quadrants using programmable phase shift in CC or CS modes.

Compared to 2-Quadrant non-regenerative AC loads, the GSZ allows simulation of inductive and capacitive loads to fully test AC power sources, as shown in the leading and lagging power factor examples.

The "L" Option adds Regenerative Electronic Load capability providing several AC and DC operating modes to push the boundaries of test environment. Simulate linear and non-linear loads (rectified), inductive and capacitive loads.

AC Modes: Constant Current, Constant Power & Apparent Power, Constant Resistance, Constant Voltage, CC+CR, CC / CS Rectifier Mode 1 ϕ & 3 ϕ

DC Modes: Constant Current, Constant Power, Constant Resistance, Constant Voltage, CR+CC

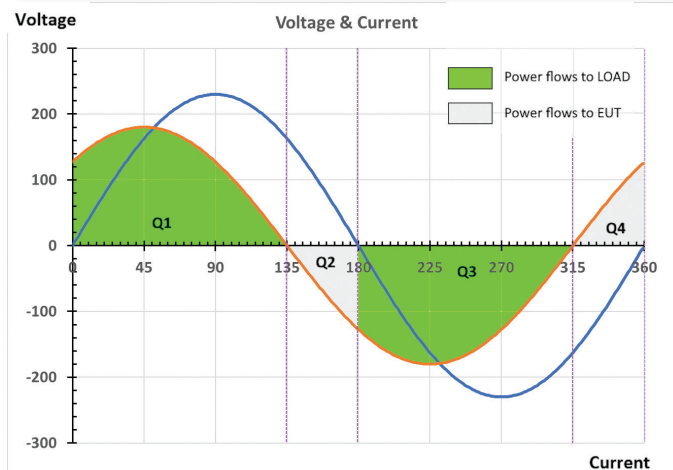
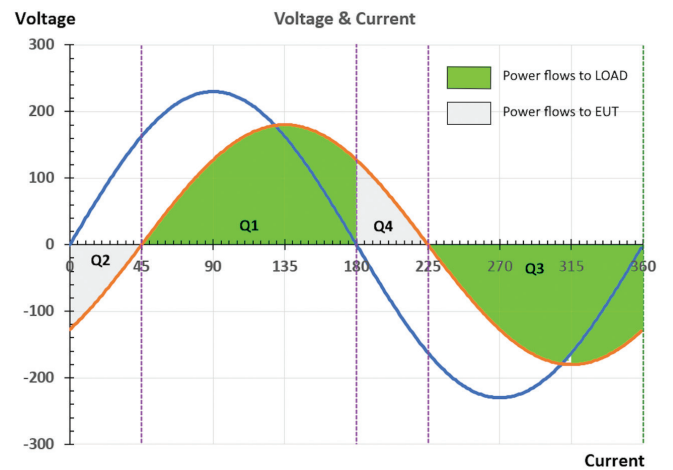

User Friendly Control Options

Multiple integrated control options include:

- Intuitive Touch Screen LCD Display with Soft Key driven Menus
- **SmartSource Suite** Web Interface
- LAN, GPIB, RS232 & USB Interfaces, and ModBus (optional)
- Supports external touch screen monitor via Video Output Interface

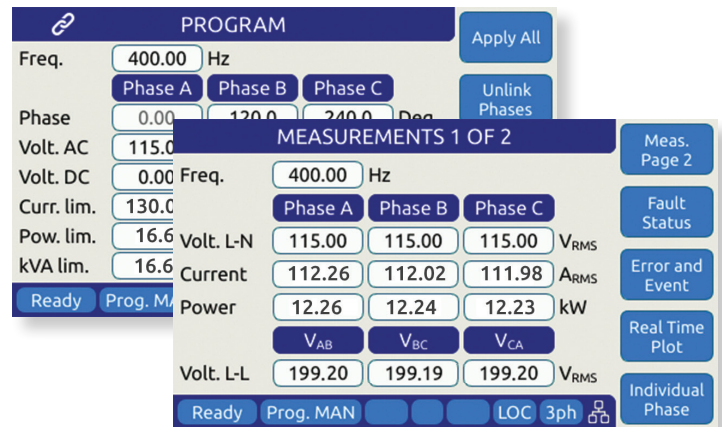

Simplify Test Automation with SmartSource Suite Remote Control Platform

Easily monitor, control, and manage testing with the GSZ's **SmartSource Suite** remote control platform. Use the embedded, web browser interface with real-time control. Access control panels and test sequences on-premises or on any mobile device (laptop, phone, tablet) via secure client access.

- Full control and measurement capability
- Program settings and measurement read back including digital scope and harmonics data
- Extensive safety protection settings
- Waveform selection, preview and edit modes
- Execution of user's custom test sequences
- Transient data entry and execution screen using a spreadsheet layout

Built-in Galvanic Isolation Reduces Safety Risks

The GSZ provides both facility-to-output isolation, and phase to phase or channel to channel isolation. Galvanic isolation provides complete separation between the input and output so there is no electron flow between channels. Channel to channel isolation provides flexibility to use each phase as its own independent power source with full frequency and voltage control. The GSZ's fully isolated design reduces safety risks for the operator and prevents unexpected UUT damage by preventing unwanted current or ground loops. This built-in capability doesn't require a transformer which saves significant costs and space.

Modular Power Systems up to 440kW

The GSZ Series provides modular and scalable power to meet changing test requirements. Easily parallel multiple cabinets to achieve higher power. Cabinets can be paralleled up to 440kW. The ease of re-configuration allows for flexible test set ups and reduces downtime for repairs or maintenance. Its top vent, air-cooled design allows the flexibility to place the GSZ cabinets against a wall or back-to-back if needed, maximizing floor space.

This robust solution also has a built-in line transformer and EMI input filters that provides galvanic isolation between the grid and the unit under test, which is ideal for use in environments where grid power may be highly distorted or 'dirty'.



GSZ Cabinet Dimensions

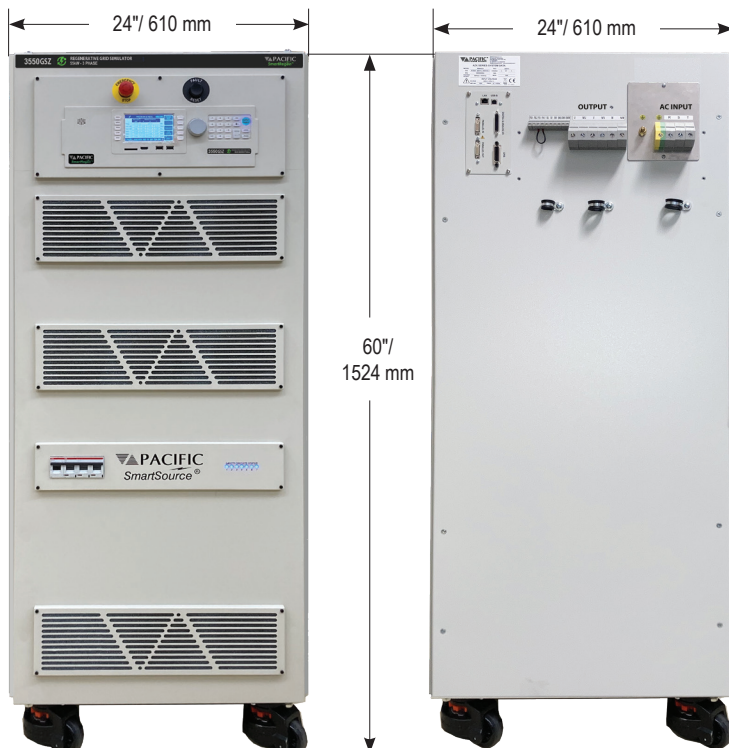

The GSZ is housed in a custom floor standing cabinet on locable casters for easy of movement and placement.

Depth of the cabinet is only 32.0 inches / 813 mm and not clearance is required behind the GSZ cabinet rear as air is vented out through the top of the cabinet..

The GSZ Rear Panel provides connections for AC Input, AC or DC Output, External Sense, Aux I/O, remote control interfaces, parallel bus connections and optional HIL Interface connector.

A safety cover for all power connections is included with each unit. (Not shown).

Technical Specifications

MODEL:	3300GSZ	3450GSZ	3550GSZ
Modes of Operation			
Regenerative Grid Simulator, Regenerative DC Power Source. Regenerative Electronic Load optional			
AC or DC Output			
Phase Modes (Form)	1, 2 or 3	1, 2 or 3	1, 2 or 3
Maximum Power (Total)	30 kW/kVA	45 kW/kVA	55 kW/kVA ¹
Per Phase / Channel	10 kW/kVA	15 kW/kVA	18.3 kW/kVA
Voltage			
Range	AC High Range: 0 - 440 V _{LN} / 0 - 390 V _{LL} DC Low Range: 0 - ±650 V _{DC} AC Low Range: 0 - 225 V _{LN} / 0 - 760 V _{LL} DC High Range: 0 - ±335 V _{DC}		
Resolution	0.01 V	Accuracy	± 0.1% F.S
Harmonic Distortion R Load	< 100 Hz: < 0.2%, 100~1000 Hz: < 0.2% + 0.125%/100Hz		
Load Regulation	± 0.02% (CSC Mode)	Line Regulation	< 0.1% for 10% Line Change
Phase Angle - Range (B, C)			
Maximum Current			
Three Phase modes AC / DC	45.0 Arms / 30.0 Adc	65.0 Arms / 40.0 Adc	75.0 Arms / 50.0 Adc
Split Phase modes AC / DC	68.0 Arms / 45.0 Adc	72.0 Arms / 45.0 Adc	75.0 Arms / 50.0 Adc
Single Phase mode AC / DC	135.0 Arms / 90.0 Adc	195.0 Arms / 120.0 Adc	225.0 Arms / 150.0 Adc
Max. Peak Current per phase (AC)	Low Vac Range: 360Apk / High Vac Rang: 180Apk		
Frequency			
Range	DC, 15 Hz – 200 Hz	Resolution / Accuracy	0.01 Hz / ± 0.005% (50 ppm)
AC Input			
Input Voltage Range / Freq	380Vac – 400Vac (-4) or 480Vac (-8) ± 10%, 4 Wire, L1, L2, L3 and PE / 47 - 63 Hz		
Nom. Phase Current @ 400Vac / 480Vac	54 Arms or 43 Arms	80 Arms or 65 Arms	100 Arms or 80 Arms
Input Power Factor	> 0.99 @ Full Load	Efficiency	90 %
Measurements			
Vrms Range / Accuracy	0 – 440 V _{LN} / 0-760 V _{LL} / 0.1% F.S.		
Irms Range / Accuracy	High Range: 0-130 Arms, Low Range: 0-75 Arms / ± (0.25% + f (kHz) * 0.25%) F.S.		
Power Range / Accuracy	0 - 30 kVA / ± 0.75 % F.S.	0 - 45 kVA / ± 0.75 % F.S.	0 - 55 kVA / ± 0.75 % F.S.
Frequency Range / Accuracy	15 Hz - 200 Hz / 0.1% Rdg	Resolution	0.01 Hz
Transient Functions			
Programming	200 Steps / 400 Segments, LIST, PULSE & STEP Modes, Frequency, Volt AC, Volt DC, Waveform, Ramp Time, Dwell Time. Time range: 0.1 - 10000000.0 ms, Time resolution 0.2 ms		
Execution	Run from step # to step #, Run, Step, Restart, Stop	Program Storage:	Non-volatile, 100 Programs + Transients
PARAMETERS / FUNCTIONS SPECIFICATIONS			
Remote Control Interfaces			
Standard	USB Type B, LAN (LXI), GPIB / IEEE488, RS232, all on rear panel		
Optional	External USB WIFI adapter / ModBus TCP / CAN/CAN-FD		
Analog & Digital I/O			
Analog I/O Inputs / Outputs	In: Voltage phs A,B,C & Frequency / Out: Analog Out: Vmeas A, B, C, Pmeas all Phases		
Digital I/O Inputs / Outputs	In: Remote Inhibit, Trans. Trig., Phase Sync, User / Out: Output Relay, Transient, Function Strobe, Sync		
PHIL Interface (Option H)	Inputs: 3 (Voltage or Current Programming), Outputs: 6 (Voltage and Current), ±10V or ±16V		
Environmental			
Cooling	Variable Fan Speed, Front Air Intake, Top Exhaust		
Temperature Operating	0 to 40 °C / 32 to 104 °F	Temperature Storage	-20 to 70 °C/-4 to 158 °F
Humidity	< 80%, non-condensing	Altitude	2000 m / 6500 feet
System Features			
USB Ports	2 on Front Panel, 1 on Rear Panel, All Type A		SD Card: 32 GB max. Capacity
Dimensions & Weights			
Chassis Size H x W x D	59.8" x 24.0" x 31.9" / 1520 x 610 x 810 mm Crated: 71" x 32" x 44" / 1520 x 610 x 810 mm		
Cabinet Weight	517 Kg / 1140 lbs	Shipping Weight:	592 Kg / 1305 lbs
Regulatory Compliance			
Safety	IEC 61010-1:2010 (Edition 3)		
EMC - Emissions / Immunity	EN 55011:2009+A1:2010 / EN 61000-4-2, -4-3, -4-4, -4-5, -4-6, -4-8 and EN 61000-4 -11		
Product Category	EN 61326-1:2013 (Measurement, Laboratory and Control Equipment)		
Agency Approvals	CE Mark	RoHS (2011/65/EU):	EN50581:2012

Ordering Information

GSZ Series Models			
Single Cabinets	Parallel Systems	Input Voltage (V _{IN}) Identifier	Options
3300GSZ	3900GSZ	-4 380-400Vac 3 ϕ \pm 10%, 47-63Hz	A Adds AC+DC Mode
3450GSZ	31100GSZ	-8 480Vac 3 ϕ \pm 10%, 47-63Hz	B For use with ECTS2 System
3550GSZ	31650GSZ		D Safety Performance Level D
	32200GSZ		F Extends Freq Range to 1000Hz
		Export Version postfix	H Real Time I/O for PHIL
		E Append "E" if F option	L Electronic Load Mode
			W Isolated Neutral Wiring

Note 1: Contact Factory for higher power GSZ system configurations.

Order Example 3550GSZ-4CL

- GSZ Cabinet, 55 kVA, 3-Phase, Grid Simulator, 380~400Vac input, IEC413, Load option

Typical Delivery Items

- Power Source
- Cert. of Compliance

GSZ Model Configurator

Dashed boxes are optional.

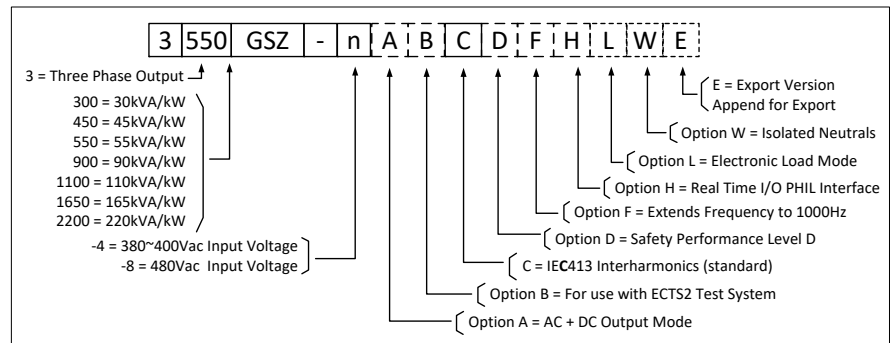

SmartSource Suite Test Sequence Options

IEC Test Sequences	Other Test Sequences
<ul style="list-style-type: none"> • IEC Test Suite - Includes IEC 61000-4-11p, IEC 61000-4-14, IEC 61000-4-17, IEC 61000-4-27p, IEC 61000-4-28, IEC 61000-4-29p and IEC 61000-4-34p • IEC 61000-4-13 (Option C) • KS C 9610-4-11, KS C 9610-4-29 	<ul style="list-style-type: none"> • IEEE 1547.1-2020 • Semi-F47-0706

Service & Support

NORTH AMERICA

Pacific Power Source, Inc.
Irvine, USA

Phone: +1(949) 251-1800
Fax: +1 (949) 756-0756
Email: info@pacificpower.com
Web: www.pacificpower.com

EUROPE

Pacific Power Source
Europe GmbH.

Kappelrodeck, Germany
Phone: +49 7842 99722-20
Fax: +49 7842 99722-29
Email: info@pacificpower.eu
Web: www.pacificpower.eu

UNITED KINGDOM

Caltest Instruments Ltd.
Petersfield, UK

Phone: +44 (0) 1483 302 700
Email: sales@caltest.co.uk
Web: www.caltest.co.uk

CHINA

PPST Shanghai Co. Ltd.
Shanghai, China

Phone: +86-21-6763-9223
Fax: +86-21-5763-8240
Email: info@ppst.com.cn
Web: www.ppst.com.cn

2802 Kelvin Avenue, Suite 100
Irvine, CA 92614 -5897 USA
Phone: +1 949.251.1800
Fax: +1 949.756.0756
Toll Free: 800.854.2433
E-mail: sales@pacificpower.com
Web: www.pacificpower.com